

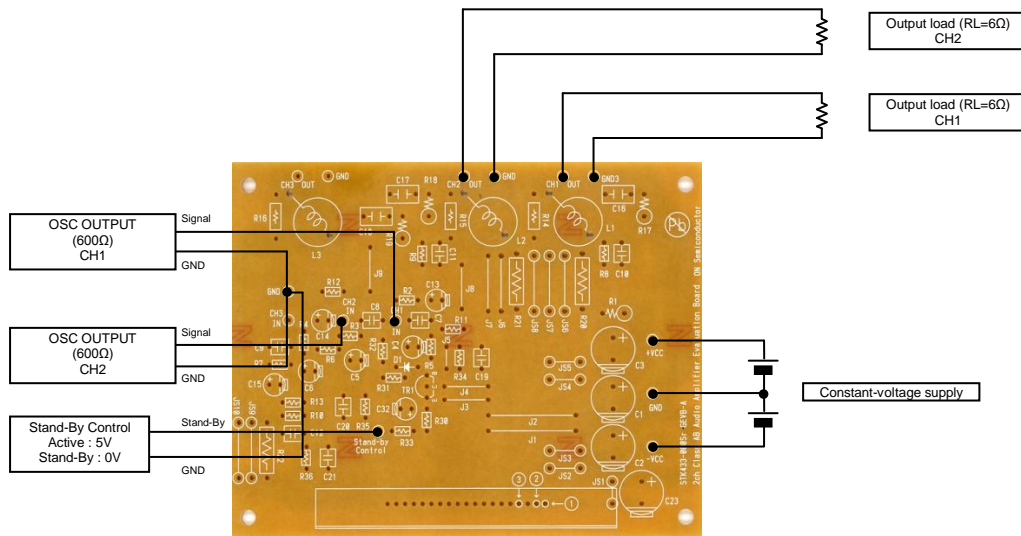

Test Procedure for the STK433-060NGEVB Evaluation Board

Characteristics confirmation

[Connection Diagram]



Sound quality confirmation, load short-circuit test, noise examination

[Connection Diagram]

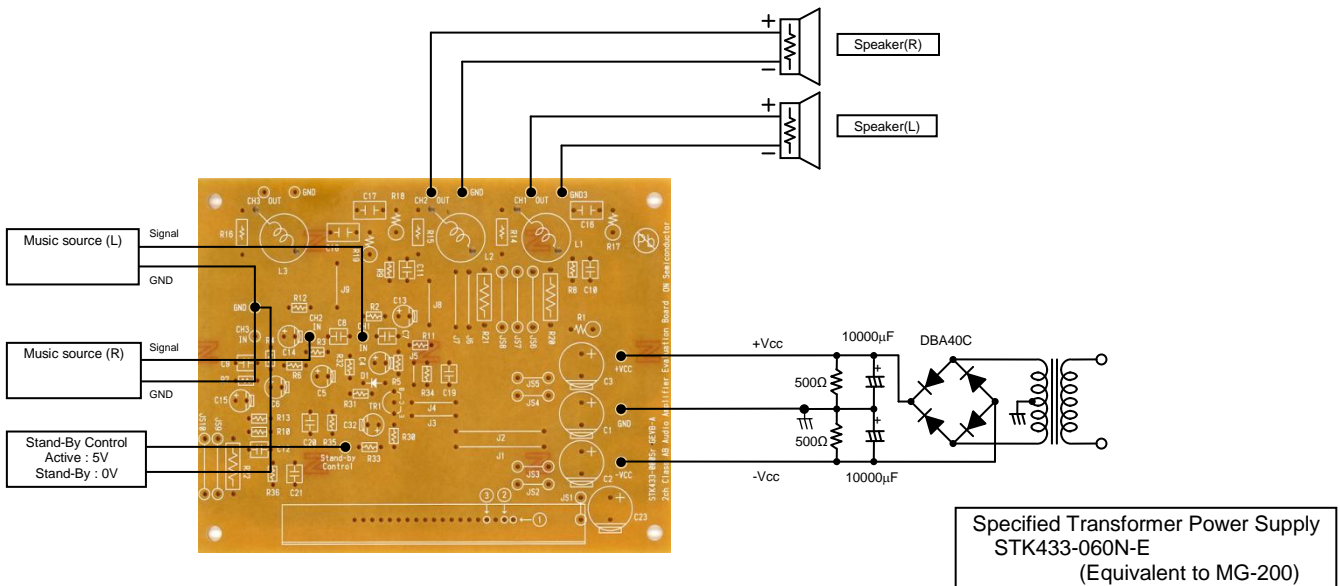



[Required Equipment]

Equipment	Efficiency
Power supply +Vcc	60V-6A
Power supply -Vcc	60V-6A
Power supply Stand-By Control	10V-1A
Load	6Ω (Non-inductive load)
Measurement	Audio analyzer (Panasonic VP-7723B)

[Supply Voltage]

+Vcc/-Vcc : Power Supply for audio power amplifiers

Output 1 (10%/1kHz)	50W x 2 ch
Output 2 (0.4%/2Hz-20kHz)	35W x 2 ch
Recommended operating Vcc (60hm)	± 27V

Stand-By Control (5V) : Power Supply for Stand-By Control Input

5V : Operation / 0V : Stand-by

[Operation Guide]

1. Installation of the heat sink
2. Load Connection
3. Power Supply Connection
4. Stand-By Control Connection
5. Input Connection

Please refer to a thermal design tip for the amplifier.
 Connect the RL=6Ω (Non-inductive load)
 Connect the +Vcc/-Vcc (Output off : 0V)
 Stand-By Control = 0V : Stand-by
 Connect the Oscillator (Sine wave / Output resistance 600Ω)

6. Power Supply

The gain of the evaluation board is set in 30dB.
 At first, supply DC voltage to +Vcc and -Vcc.
 Next, Stand-By Control = 5V : Operation

