

# Rectifiers, Surface Mount

3 A, 50 V-1000 V

S3AB-S3MB

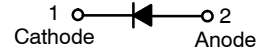

SMB  
CASE 403AF

MARKING  
DIAGRAM

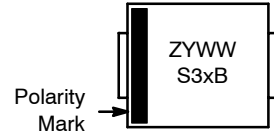

Z = Assembly Plant Code  
Y = Year  
WW = Work Week  
S3xB = Specific Device Code  
x = A, B, D, G, J, K, M

Features

- Glass Passivated Chip Junction
- High Surge Current Capacity
- Low Forward Voltage: 1.15 V Maximum
- UL Flammability 94V-0 Classification
- MSL 1 per J-STD-020
- RoHS Compliant / Green Molding Compound
- NRV Prefix for Automotive and Other Applications Requiring Unique Site and Control Change Requirements; AEC-Q101 Qualified and PPAP Capable
- These are Pb-Free and Halide Free Devices

ORDERING INFORMATION

See detailed ordering and shipping information on page 3 of this data sheet.

NOTE: Some of the devices on this data sheet have been **DISCONTINUED**. Please refer to the table on page 3.

ABSOLUTE MAXIMUM RATINGS Values are at T<sub>A</sub> = 25°C unless otherwise noted.

Symbol	Parameter	Value							Unit
		S3AB	S3BB	S3DB	S3GB	S3JB	S3KB	S3MB	
V <sub>RRM</sub>	Repetitive Peak Reverse Voltage	50	100	200	400	600	800	1000	V
V <sub>RMS</sub>	RMS Reverse Voltage	35	70	140	280	420	560	700	V
V <sub>R</sub>	DC Blocking Voltage	50	100	200	400	600	800	1000	A
I <sub>F(AV)</sub>	Average Forward Rectified Current	3							A
I <sub>FSM</sub>	Peak Forward Surge Current: 8.3 ms Single Half Sine-Wave Superimposed on Rated Load	80							A
T <sub>J</sub>	Operating Junction Temperature Range	-55 to 150							°C
T <sub>STG</sub>	Storage Temperature Range	-55 to 150							°C

Stresses exceeding those listed in the Maximum Ratings table may damage the device. If any of these limits are exceeded, device functionality should not be assumed, damage may occur and reliability may be affected.

THERMAL CHARACTERISTICS Values are at T<sub>A</sub> = 25°C unless otherwise noted. (Note 1)

Symbol	Parameter	Value	Unit
R <sub>θJA</sub>	Typical Thermal Resistance, Junction-to-Ambient	148	°C/W
Ψ <sub>JL</sub>	Typical Thermal Characteristics, Junction-to-Lead	14	°C/W

1. Device mounted on FR-4 PCB, board size = 76.2 mm x 114.3 mm per JESD51-3.

ELECTRICAL CHARACTERISTICS Values are at T<sub>A</sub> = 25°C unless otherwise noted.

Symbol	Parameter	Test Conditions	Min	Typ	Max	Unit
V <sub>F</sub>	Instantaneous Forward Voltage (Note 2)	I <sub>F</sub> = 3 A	-	-	1.15	V
I <sub>R</sub>	Reverse Current at Rated V <sub>R</sub>	T <sub>J</sub> = 25°C	-	-	10	μA
		T <sub>J</sub> = 125°C	-	-	250	
t <sub>rr</sub>	Reverse Recovery Time	I <sub>F</sub> = 0.5 A, I <sub>R</sub> = 1 A, I <sub>rr</sub> = 0.25 A	-	1.5	-	μs
C <sub>J</sub>	Junction Capacitance	V <sub>R</sub> = 4 V, f = 1 MHz	-	40	-	pF

Product parametric performance is indicated in the Electrical Characteristics for the listed test conditions, unless otherwise noted. Product performance may not be indicated by the Electrical Characteristics if operated under different conditions.

2. Pulse test with PW = 300 μs, 1% duty cycle.

TYPICAL PERFORMANCE CHARACTERISTICS

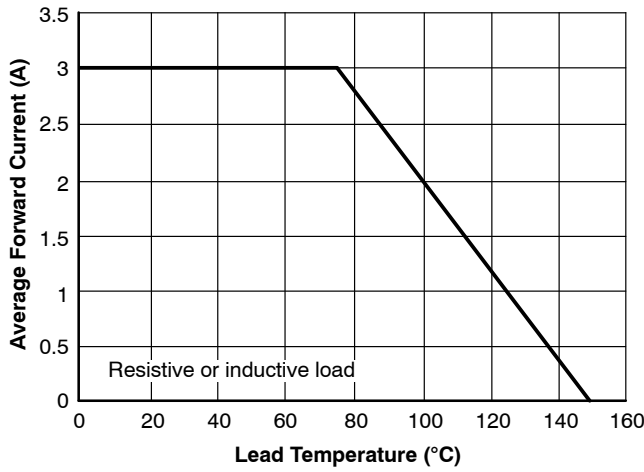

Figure 1. Forward Current Derating Curve

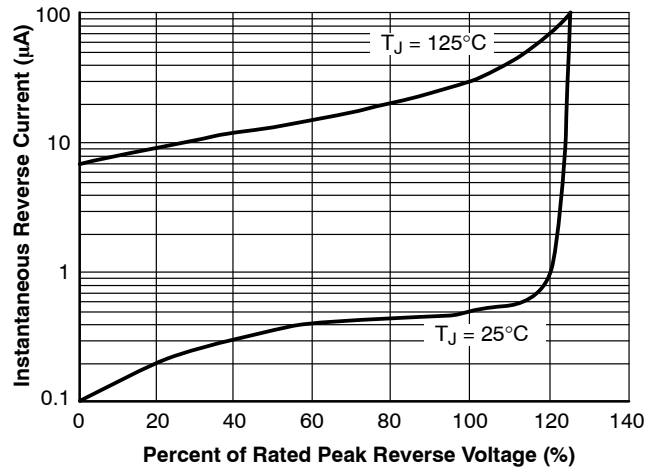

Figure 2. Typical Reverse Characteristics

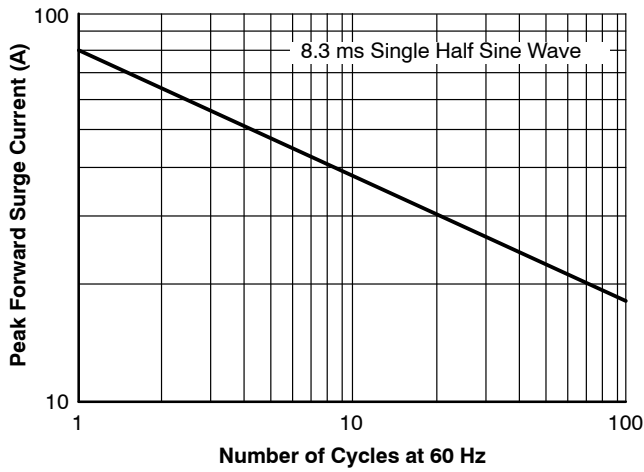

Figure 3. Maximum Non-Repetitive Forward Surge Current

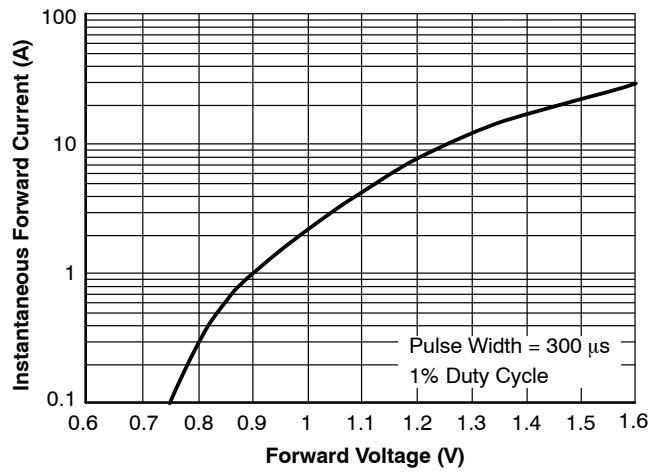

Figure 4. Typical Forward Characteristics

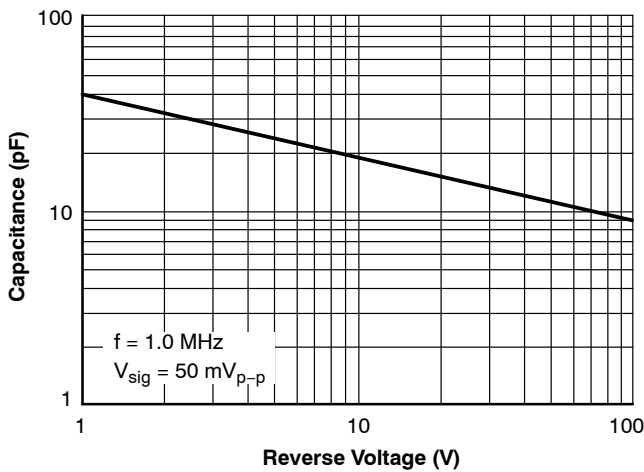
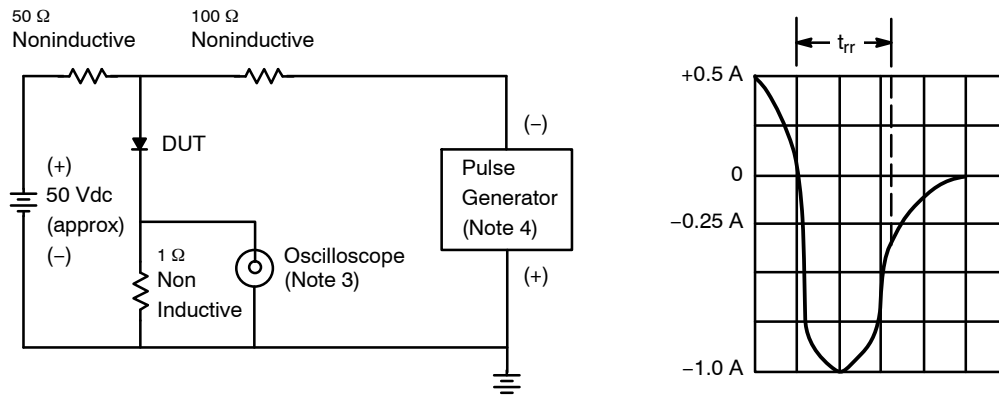

Figure 5. Typical Junction Capacitance

# S3AB-S3MB

## TEST CIRCUIT DIAGRAM



**Figure 6. Reverse Recovery Time Characteristic and Test Circuit Diagram**

### NOTES:

3. Rise Time = 7 ns max. Input Impedance = 1 MΩ, 22 pF
4. Rise Time = 10 ns max. Source Impedance = 50 Ω, 22 pF

### ORDERING INFORMATION

Part Number	Device Code Marking	Package	Shipping <sup>†</sup>
NRVS3BB*	S3BB	SMB (Pb-Free, Halide-Free)	3000 / Tape & Reel
S3DB	S3DB		
S3GB, NRVS3GB*	S3GB		
S3JB, NRVS3JB*	S3JB		
S3KB	S3KB		
S3MB, NRVS3MB*	S3MB		

### DISCONTINUED (Note 5)

S3AB, NRVS3AB*	S3AB	SMB (Pb-Free, Halide-Free)	3000 / Tape & Reel
S3BB	S3BB		
NRVS3DB*	S3DB		
NRVS3KB*	S3KB		

<sup>†</sup>For information on tape and reel specifications, including part orientation and tape sizes, please refer to our Tape and Reel Packaging Specifications Brochure, [BRD8011/D](#).

\*NRV Prefix for Automotive and Other Applications Requiring Unique Site and Control Change Requirements; AEC-Q101 Qualified and PPAP Capable

5. **DISCONTINUED:** These devices are not recommended for new design. Please contact your **onsemi** representative for information. The most current information on these devices may be available on [www.onsemi.com](http://www.onsemi.com).

# MECHANICAL CASE OUTLINE

## PACKAGE DIMENSIONS

ON Semiconductor®



### SMB CASE 403AF ISSUE O

DATE 31 AUG 2016



DETAIL A  
SCALE 20 : 1

#### NOTES:

- A. EXCEPT WHERE NOTED CONFORMS TO JEDEC DO214 VARIATION AA.
- $\triangle$  B DOES NOT COMPLY JEDEC STD. VALUE.
- C. ALL DIMENSIONS ARE IN MILLIMETERS.
- D. DIMENSIONS ARE EXCLUSIVE OF BURRS, MOLD FLASH AND TIE BAR PROTRUSIONS.
- E. DIMENSION AND TOLERANCE AS PER ASME Y14.5-1994.
- F. LAND PATTERN STD. DIOM5336X240M.

<b>DOCUMENT NUMBER:</b>	<b>98AON13441G</b>	Electronic versions are uncontrolled except when accessed directly from the Document Repository. Printed versions are uncontrolled except when stamped "CONTROLLED COPY" in red.
<b>DESCRIPTION:</b>	<b>SMB</b>	<b>PAGE 1 OF 1</b>

ON Semiconductor and are trademarks of Semiconductor Components Industries, LLC dba ON Semiconductor or its subsidiaries in the United States and/or other countries. ON Semiconductor reserves the right to make changes without further notice to any products herein. ON Semiconductor makes no warranty, representation or guarantee regarding the suitability of its products for any particular purpose, nor does ON Semiconductor assume any liability arising out of the application or use of any product or circuit, and specifically disclaims any and all liability, including without limitation special, consequential or incidental damages. ON Semiconductor does not convey any license under its patent rights nor the rights of others.

**onsemi**, **Onsemi**, and other names, marks, and brands are registered and/or common law trademarks of Semiconductor Components Industries, LLC dba "**onsemi**" or its affiliates and/or subsidiaries in the United States and/or other countries. **onsemi** owns the rights to a number of patents, trademarks, copyrights, trade secrets, and other intellectual property. A listing of **onsemi**'s product/patent coverage may be accessed at [www.onsemi.com/site/pdf/Patent-Marking.pdf](http://www.onsemi.com/site/pdf/Patent-Marking.pdf). **onsemi** reserves the right to make changes at any time to any products or information herein, without notice. The information herein is provided "as-is" and **onsemi** makes no warranty, representation or guarantee regarding the accuracy of the information, product features, availability, functionality, or suitability of its products for any particular purpose, nor does **onsemi** assume any liability arising out of the application or use of any product or circuit, and specifically disclaims any and all liability, including without limitation special, consequential or incidental damages. Buyer is responsible for its products and applications using **onsemi** products, including compliance with all laws, regulations and safety requirements or standards, regardless of any support or applications information provided by **onsemi**. "Typical" parameters which may be provided in **onsemi** data sheets and/or specifications can and do vary in different applications and actual performance may vary over time. All operating parameters, including "Typicals" must be validated for each customer application by customer's technical experts. **onsemi** does not convey any license under any of its intellectual property rights nor the rights of others. **onsemi** products are not designed, intended, or authorized for use as a critical component in life support systems or any FDA Class 3 medical devices or medical devices with a same or similar classification in a foreign jurisdiction or any devices intended for implantation in the human body. Should Buyer purchase or use **onsemi** products for any such unintended or unauthorized application, Buyer shall indemnify and hold **onsemi** and its officers, employees, subsidiaries, affiliates, and distributors harmless against all claims, costs, damages, and expenses, and reasonable attorney fees arising out of, directly or indirectly, any claim of personal injury or death associated with such unintended or unauthorized use, even if such claim alleges that **onsemi** was negligent regarding the design or manufacture of the part. **onsemi** is an Equal Opportunity/Affirmative Action Employer. This literature is subject to all applicable copyright laws and is not for resale in any manner.

## ADDITIONAL INFORMATION

### TECHNICAL PUBLICATIONS:

Technical Library: [www.onsemi.com/design/resources/technical-documentation](http://www.onsemi.com/design/resources/technical-documentation)  
onsemi Website: [www.onsemi.com](http://www.onsemi.com)

### ONLINE SUPPORT: [www.onsemi.com/support](http://www.onsemi.com/support)

For additional information, please contact your local Sales Representative at [www.onsemi.com/support/sales](http://www.onsemi.com/support/sales)