

**Silicon Carbide (SiC)
Module – EliteSiC, 10 mohm
SiC M1 MOSFET, 1200 V,
2-PACK Half Bridge
Topology, F1 Package**

**NXH010P120MNF1PTNG,
NXH010P120MNF1PNG,
NXH010P120MNF1PTG,
NXH010P120MNF1PG**

General Description

The NXH010P120MNF1 is a power module containing an 10 mΩ/1200 V SiC MOSFET half bridge and a thermistor in an F1 package.

Features

- 10 mΩ/1200 V SiC MOSFET Half Bridge
- Thermistor
- Options With Pre-Applied Thermal Interface Material (TIM) and Without Pre-Applied TIM
- Press-Fit Pins

Typical Applications

- Solar Inverter
- Uninterruptible Power Supplies
- Electric Vehicle Charging Stations
- Industrial Power

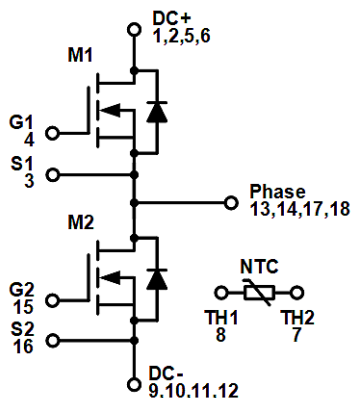
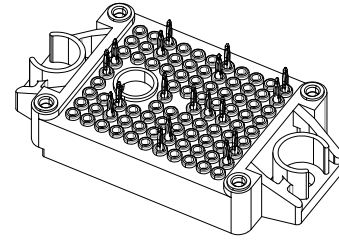
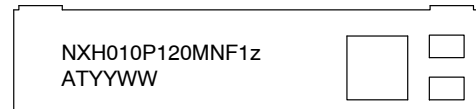

Figure 1. NXH010P120MNF1 Schematic Diagram



PIM18 33.8x42.5 (PRESS FIT)
CASE 180BW

MARKING DIAGRAM



NXH010P120MNF1z = Specific Device Code
z = PTNG/PNG/PTG/PG
AT = Assembly & Test Site Code
YYWW = Year and Work Week Code

ORDERING INFORMATION

See detailed ordering and shipping information on page 4 of this data sheet.

**NXH010P120MNF1PTNG, NXH010P120MNF1PNG, NXH010P120MNF1PTG,
NXH010P120MNF1PG**

PIN CONNECTIONS

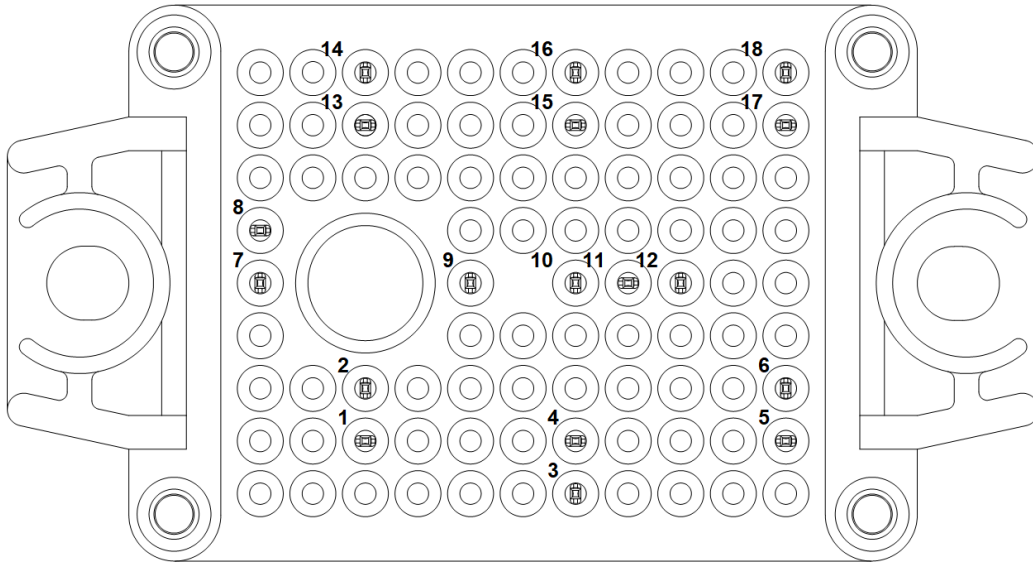

Figure 2. Pin Connections

PIN FUNCTION DESCRIPTION

Pin	Name	Description
8	TH1	Thermistor Connection 1
7	TH2	Thermistor Connection 2
1	DC+	DC Positive Bus connection
2	DC+	DC Positive Bus connection
13	PHASE	Center point of half bridge
14	PHASE	Center point of half bridge
9	DC-	DC Negative Bus connection
3	S1	Q1 Kelvin Emitter (High side switch)
4	G1	Q1 Gate (High side switch)
10	DC-	DC Negative Bus connection
15	G2	Q2 Gate (Low side switch)
16	S2	Q2 Kelvin Emitter (High side switch)
11	DC-	DC Negative Bus connection
12	DC-	DC Negative Bus connection
5	DC+	DC Positive Bus connection
6	DC+	DC Positive Bus connection
17	PHASE	Center point of half bridge
18	PHASE	Center point of half bridge

NXH010P120MNF1PTNG, NXH010P120MNF1PNG, NXH010P120MNF1PTG, NXH010P120MNF1PG

Table 1. ABSOLUTE MAXIMUM RATINGS (Note 1)

Rating	Symbol	Value	Unit
SIC MOSFET			
Drain–Source Voltage	V_{DSS}	1200	V
Gate–Source Voltage	V_{GS}	+25/–15	V
Continuous Drain Current @ $T_c = 80^\circ\text{C}$ ($T_J = 175^\circ\text{C}$)	I_D	114	A
Pulsed Drain Current ($T_J = 175^\circ\text{C}$)	I_{Dpulse}	228	A
Maximum Power Dissipation @ $T_c = 80^\circ\text{C}$ ($T_J = 175^\circ\text{C}$)	P_{tot}	413	W
Minimum Operating Junction Temperature	T_{JMIN}	–40	$^\circ\text{C}$
Maximum Operating Junction Temperature	T_{JMAX}	175	$^\circ\text{C}$

THERMAL PROPERTIES

Storage Temperature range	T_{stg}	–40 to 150	$^\circ\text{C}$
---------------------------	-----------	------------	------------------

INSULATION PROPERTIES

Isolation Test Voltage, t = 1 sec, 60 Hz	V_{is}	4800	V_{RMS}
Creepage Distance		12.7	mm

Stresses exceeding those listed in the Maximum Ratings table may damage the device. If any of these limits are exceeded, device functionality should not be assumed, damage may occur and reliability may be affected.

1. Refer to ELECTRICAL CHARACTERISTICS, RECOMMENDED OPERATING RANGES and/or APPLICATION INFORMATION for Safe Operating parameters.

RECOMMENDED OPERATING RANGES

Rating	Symbol	Min	Max	Unit
Module Operating Junction Temperature	T_J	–40	150	$^\circ\text{C}$

Functional operation above the stresses listed in the Recommended Operating Ranges is not implied. Extended exposure to stresses beyond the Recommended Operating Ranges limits may affect device reliability.

ELECTRICAL CHARACTERISTICS

$T_J = 25^\circ\text{C}$ unless otherwise noted

Parameter	Test Conditions	Symbol	Min	Typ	Max	Unit
SIC MOSFET CHARACTERISTICS						
Drain–Source Breakdown Voltage	$V_{GS} = 0\text{ V}, I_D = 400\ \mu\text{A}$	$V_{(BR)DSS}$	1200	–	–	V
Zero Gate Voltage Drain Current	$V_{GS} = 0\text{ V}, V_{DS} = 1200\text{ V}$	I_{DSS}	–	–	200	μA
Drain–Source On Resistance	$V_{GS} = 20\text{ V}, I_D = 100\text{ A}, T_J = 25^\circ\text{C}$	$R_{DS(ON)}$	–	10.5	14	m Ω
	$V_{GS} = 20\text{ V}, I_D = 100\text{ A}, T_J = 125^\circ\text{C}$		–	14.1	–	
	$V_{GS} = 20\text{ V}, I_D = 100\text{ A}, T_J = 150^\circ\text{C}$		–	14.5	–	
Gate–Source Threshold Voltage	$V_{GS} = V_{DS}, I_D = 40\text{ mA}$	$V_{GS(TH)}$	1.8	2.90	4.3	V
Gate Leakage Current	$V_{GS} = -10/20\text{ V}, V_{DS} = 0\text{ V}$	I_{GSS}	–500	–	500	nA
Internal Gate Resistance		R_G	–	0.8	–	Ω
Input Capacitance	$V_{DS} = 800\text{ V}, V_{GS} = 0\text{ V}, f = 1\text{ MHz}$	C_{ISS}	–	4707	–	pF
Reverse Transfer Capacitance		C_{RSS}	–	39	–	
Output Capacitance		C_{OSS}	–	548	–	
C_{OSS} Stored Energy	$V_{DS} = 0\text{ V to } 800\text{ V}, V_{GS} = 0\text{ V}$	E_{OSS}	–	221	–	μJ
Total Gate Charge	$V_{DS} = 800\text{ V}, V_{GS} = 20\text{ V}, I_D = 100\text{ A}$	$Q_{G(TOTAL)}$	–	454	–	nC
Gate–Source Charge		Q_{GS}	–	129	–	nC
Gate–Drain Charge		Q_{GD}	–	131	–	nC

NXH010P120MNF1PTNG, NXH010P120MNF1PNG, NXH010P120MNF1PTG, NXH010P120MNF1PG

ELECTRICAL CHARACTERISTICS (continued)

T_J = 25°C unless otherwise noted

Parameter	Test Conditions	Symbol	Min	Typ	Max	Unit
SiC MOSFET CHARACTERISTICS						
Turn-on Delay Time	T _J = 25°C V _{DS} = 600 V, I _D = 100 A V _{GS} = -5 V/18 V, R _G = 2 Ω	t _{d(on)}	–	36	–	ns
Rise Time		t _r	–	16.2	–	
Turn-off Delay Time		t _{d(off)}	–	135.2	–	
Fall Time		t _f	–	13	–	mJ
Turn-on Switching Loss per Pulse		E _{ON}	–	1.47	–	
Turn off Switching Loss per Pulse		E _{OFF}	–	0.33	–	
Turn-on Delay Time	T _J = 150°C V _{DS} = 600 V, I _D = 100 A V _{GS} = -5 V/18 V, R _G = 2 Ω	t _{d(on)}	–	30.5	–	ns
Rise Time		t _r	–	15.2	–	
Turn-off Delay Time		t _{d(off)}	–	149	–	
Fall Time		t _f	–	15	–	mJ
Turn-on Switching Loss per Pulse		E _{ON}	–	1.77	–	
Turn off Switching Loss per Pulse		E _{OFF}	–	0.41	–	
Diode Forward Voltage	I _D = 100 A, T _J = 25°C	V _{SD}	–	3.94	6	V
	I _D = 100 A, T _J = 150°C		–	3.42	–	
Thermal Resistance – Chip-to-case	M1, M2	R _{thJC}	–	0.23	–	°C/W
Thermal Resistance – Chip-to-heatsink	Thermal Resistance – chip-to-heatsink, Thermal grease, Thickness = 2 Mil ±2%, A = 2.8 W/mK	R _{thJH}	–	0.38	–	°C/W

THERMISTOR CHARACTERISTICS

Nominal Resistance	T _{NTC} = 25°C	R ₂₅	–	5	–	kΩ
Nominal Resistance	T _{NTC} = 100°C	R ₁₀₀	–	493	–	Ω
Nominal Resistance	T _{NTC} = 150°C	R ₁₅₀	–	159.5	–	Ω
Deviation of R ₁₀₀	T _{NTC} = 100°C	ΔR/R	-5	–	5	%
Power Dissipation – recommended limit	0.15 mA, non-self-heating effect	P _D	–	0.1	–	mW
Power Dissipation – absolute maximum	5 mA	P _D	–	34.2	–	mW
Power Dissipation Constant			–	1.4	–	mW/K
B-value	B(25/50), tolerance ±2%		–	3375	–	K
B-value	B(25/100), tolerance ±2%		–	3436	–	K

Product parametric performance is indicated in the Electrical Characteristics for the listed test conditions, unless otherwise noted. Product performance may not be indicated by the Electrical Characteristics if operated under different conditions.

ORDERING INFORMATION

Orderable Part Number	Specific Device Marking	Package Type	Shipping [†]
NXH010P120MNF1PNG	NXH010P120MNF1PNG	F1-2PACK: Case 180BW Press-fit Pins, Ni-Plated DBC (Pb-Free and Halide-Free)	28 Units / Blister Tray
NXH010P120MNF1PTNG	NXH010P120MNF1PTNG	F1-2PACK: Case 180BW Press-fit Pins, Ni-Plated DBC with pre-applied thermal interface material (TIM) (Pb-Free and Halide-Free)	28 Units / Blister Tray
NXH010P120MNF1PG	NXH010P120MNF1PG	F1-2PACK: Case 180BW Press-fit Pins, Copper DBC (Pb-Free and Halide-Free)	28 Units / Blister Tray
NXH010P120MNF1PTG	NXH010P120MNF1PTG	F1-2PACK: Case 180BW Press-fit Pins, Copper DBC with pre-applied thermal interface material (TIM) (Pb-Free and Halide-Free)	28 Units / Blister Tray

[†]For information on tape and reel specifications, including part orientation and tape sizes, please refer to our Tape and Reel Packaging Specifications Brochure, BRD8011/D.

NXH010P120MNF1PTNG, NXH010P120MNF1PNG, NXH010P120MNF1PTG, NXH010P120MNF1PG

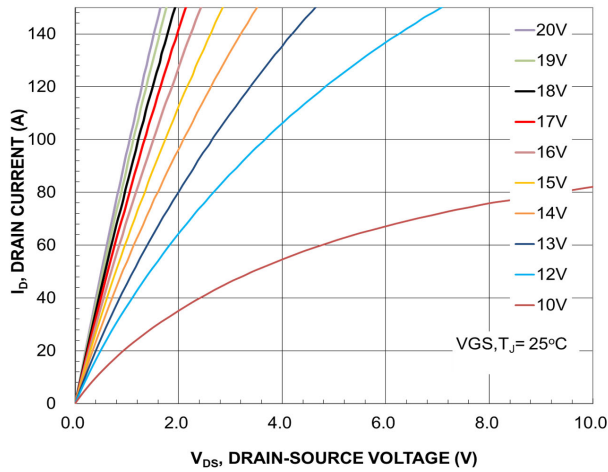

Figure 3. MOSFET Typical Output Characteristics

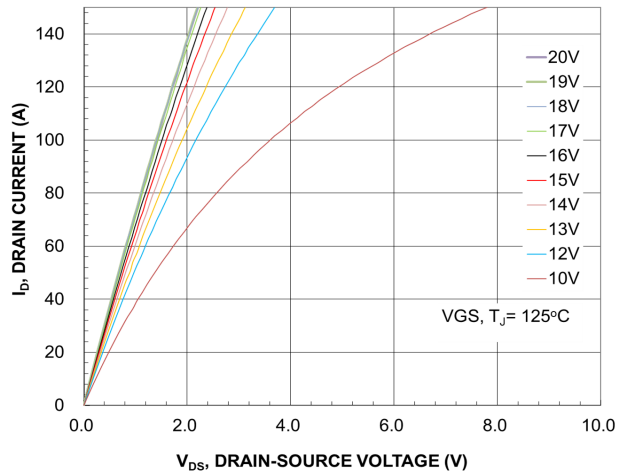

Figure 4. MOSFET Typical Output Characteristics

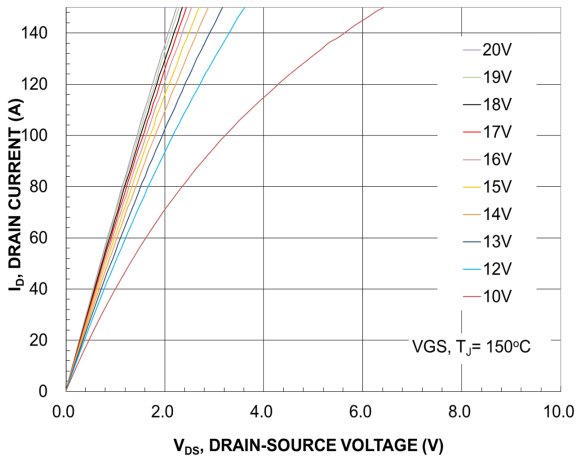

Figure 5. MOSFET Typical Output Characteristics

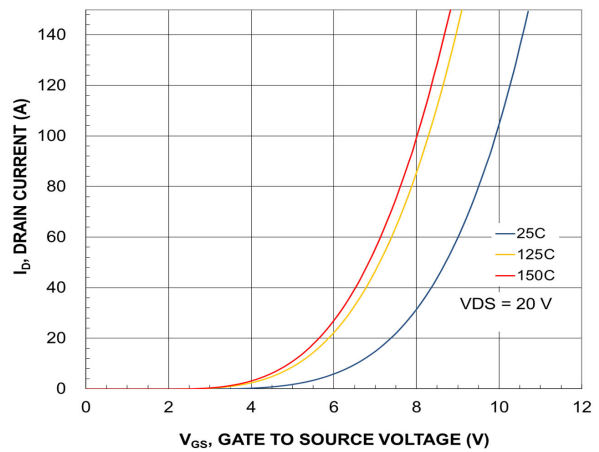

Figure 6. MOSFET Typical Transfer Characteristics

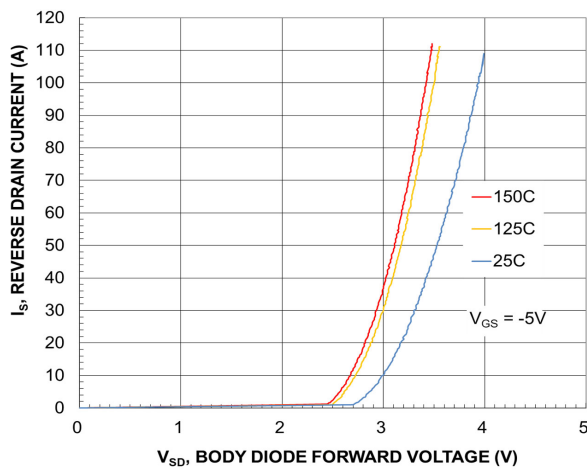

Figure 7. Body Diode Forward Characteristic

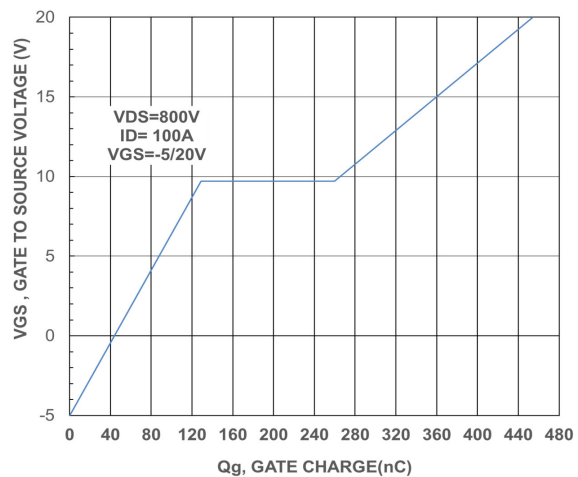

Figure 8. Gate-to-Source Voltage vs. Total Charge

**NXH010P120MNF1PTNG, NXH010P120MNF1PNG, NXH010P120MNF1PTG,
NXH010P120MNF1PG**

TYPICAL CHARACTERISTICS

SIC MOSFET (M1, M2)

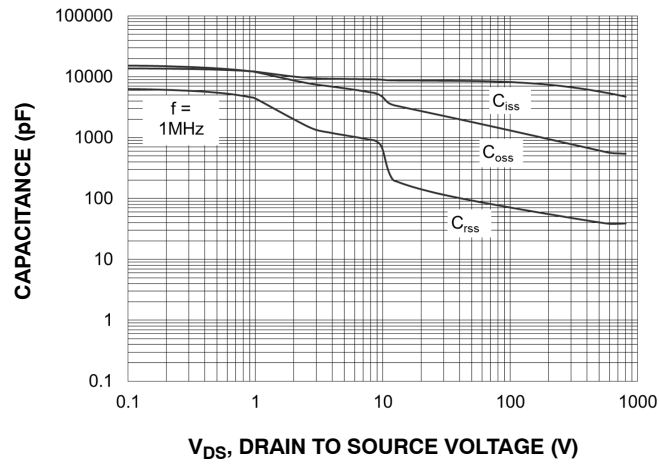

Figure 9. Capacitance vs. Drain-to-Source Voltage

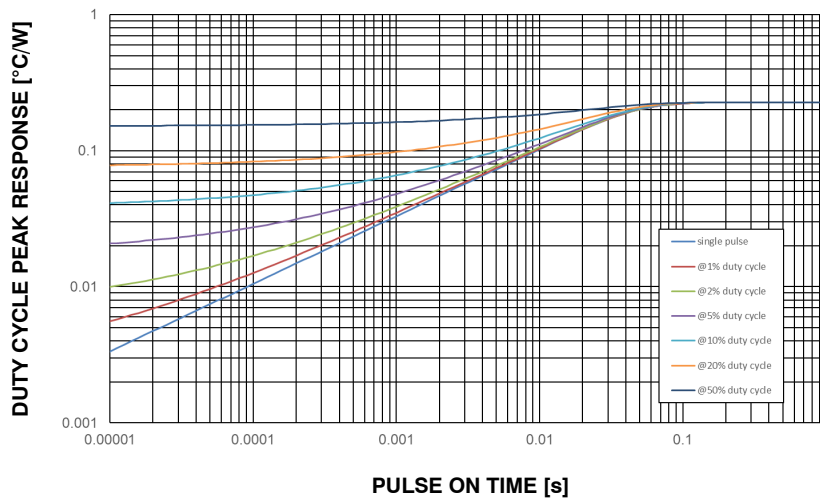

Figure 10. SiC Mosfet Junction-to-Case Transient Thermal Impedance

Element #	M1		M2	
	Rth (K/W)	Cth (Ws/K)	Rth (K/W)	Cth (Ws/K)
1	0.00569	0.00195	0.01290	0.00461
2	0.01079	0.00951	0.02387	0.02538
3	0.03005	0.01813	0.04253	0.02953
4	0.08398	0.08121	0.07199	0.08994
5	0.09325	0.11117	0.07823	0.06854

Figure 11. Table of Cauer Networks-M1, M2

NXH010P120MNF1PTNG, NXH010P120MNF1PNG, NXH010P120MNF1PTG, NXH010P120MNF1PG

TYPICAL CHARACTERISTICS

M1/M2 MOSFET SWITCHING CHARACTERISTICS

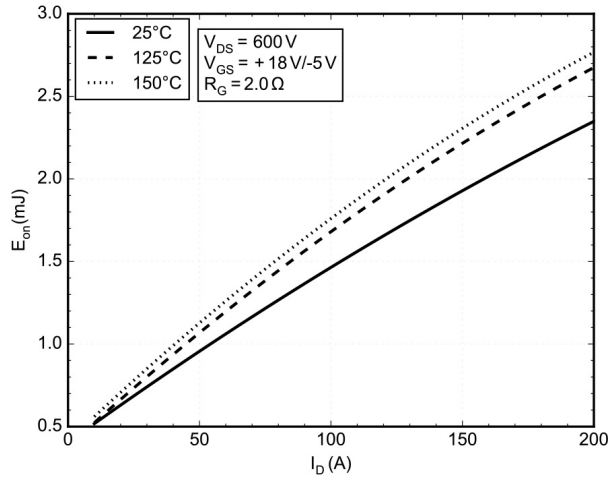

Figure 12. Typical Switching Loss E_{ON} vs. I_D

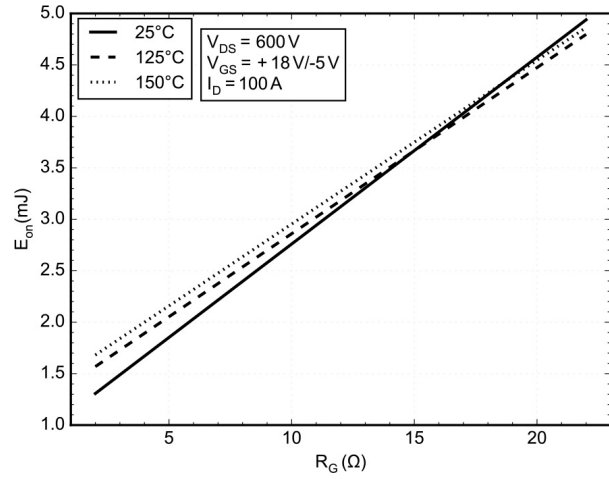

Figure 13. Typical Switching Loss E_{ON} vs. R_G

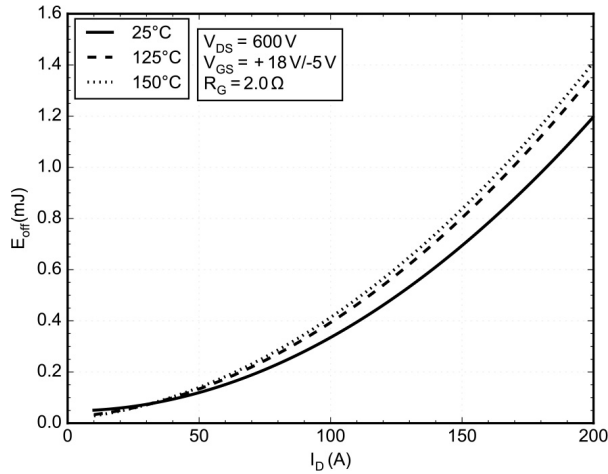

Figure 14. Typical Switching Loss E_{Off} vs. I_D

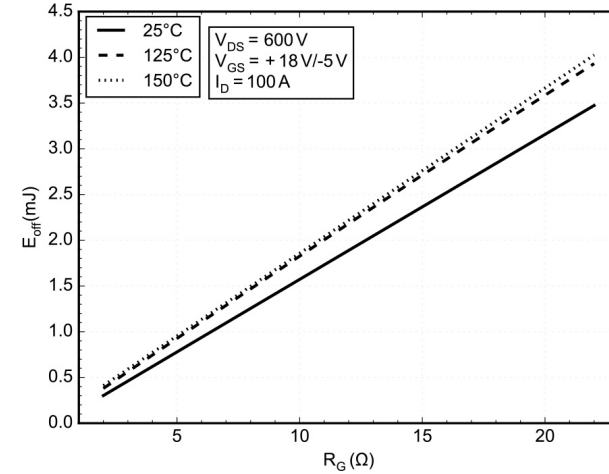

Figure 15. Typical Switching Loss E_{Off} vs. R_G

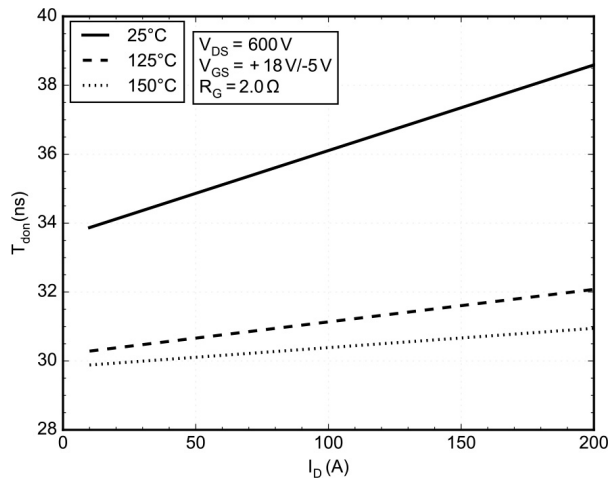

Figure 16. Typical Turn-On Switching T_{don} vs. I_D

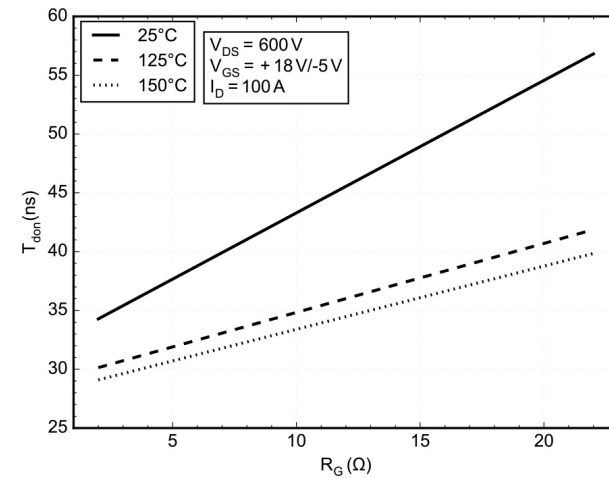

Figure 17. Typical Turn-On Switching T_{don} vs. R_G

NXH010P120MNF1PTNG, NXH010P120MNF1PNG, NXH010P120MNF1PTG, NXH010P120MNF1PG

TYPICAL CHARACTERISTICS

M1/M2 MOSFET SWITCHING CHARACTERISTICS

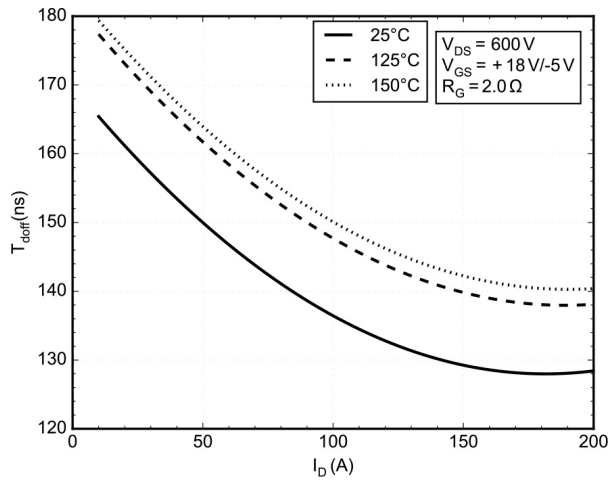

Figure 18. Typical Turn-Off Switching T_{doff} vs. I_D

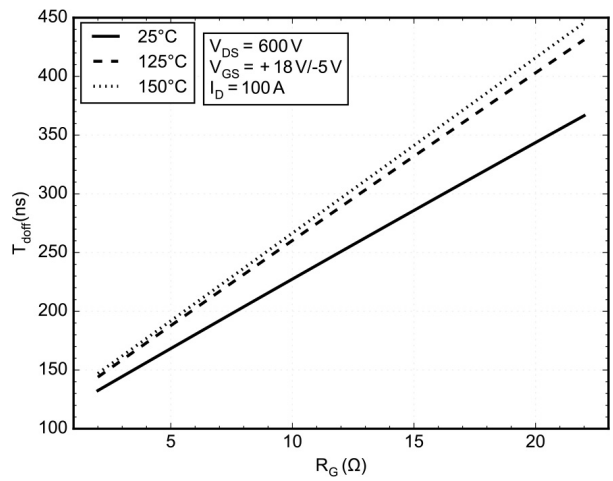

Figure 19. Typical Turn-Off Switching T_{doff} vs. R_G

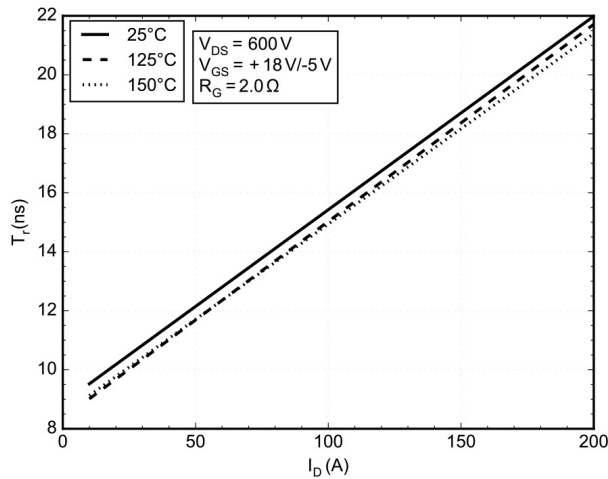

Figure 20. Typical Turn-On Switching T_r vs. I_D

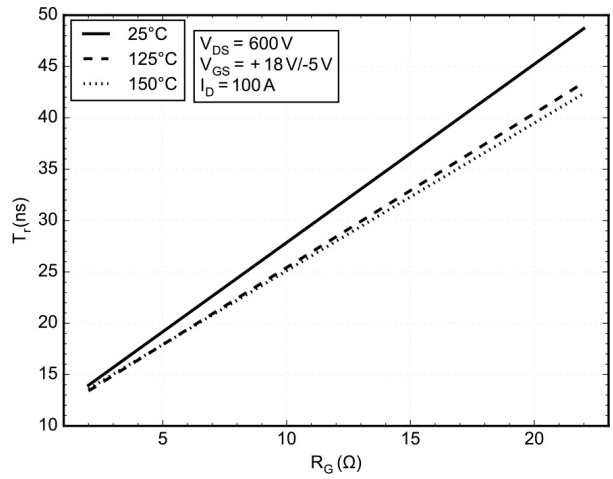

Figure 21. Typical Turn-On Switching T_r vs. R_G

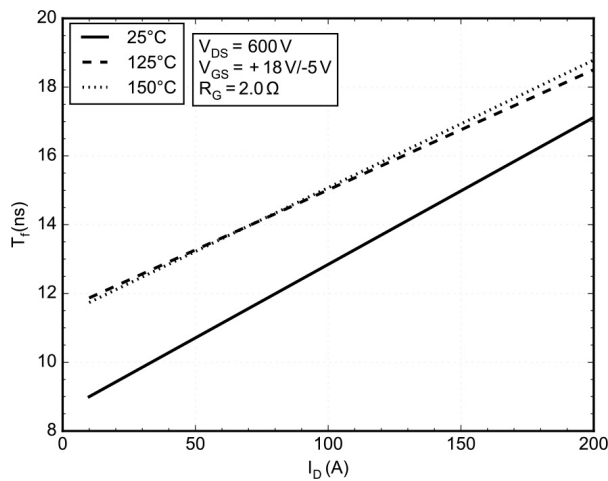

Figure 22. Typical Turn-Off Switching T_f vs. I_D

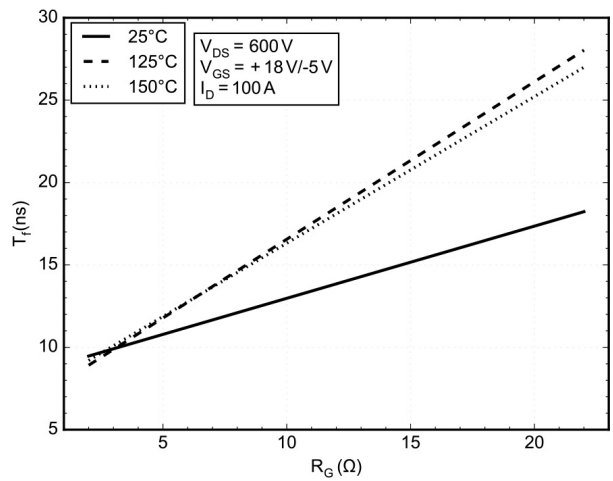

Figure 23. Typical Turn-Off Switching T_f vs. R_G

NXH010P120MNF1PTNG, NXH010P120MNF1PNG, NXH010P120MNF1PTG, NXH010P120MNF1PG

TYPICAL CHARACTERISTICS

M1/M2 MOSFET SWITCHING CHARACTERISTICS

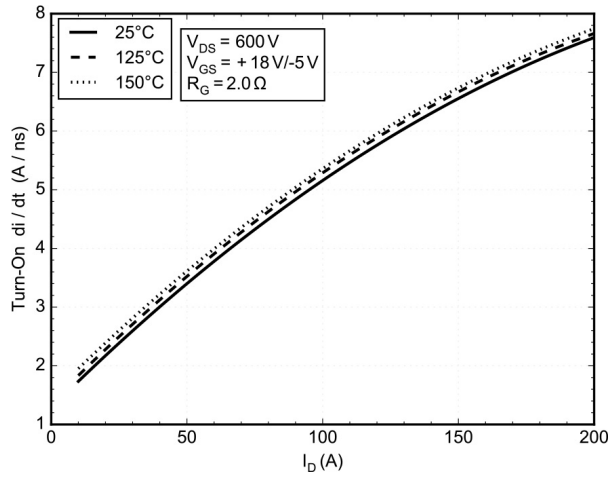

Figure 24. di/dt ON vs. ID

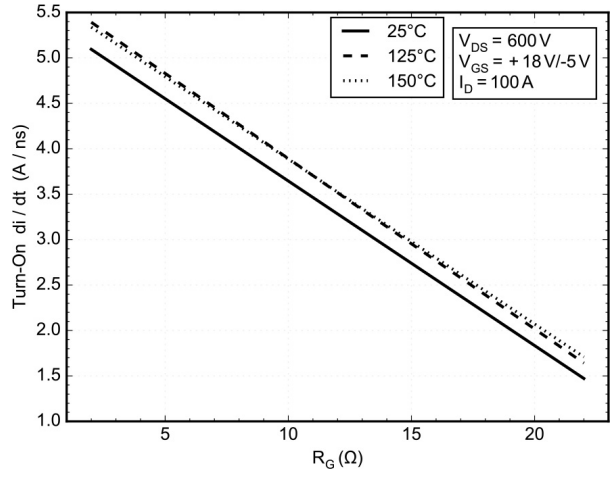

Figure 25. di/dt ON vs. R_G

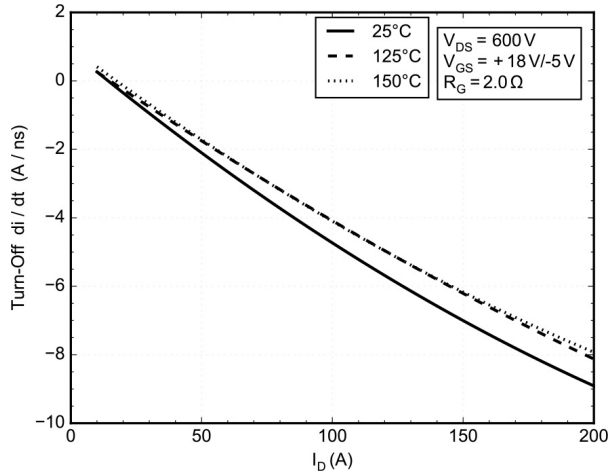

Figure 26. di/dt OFF vs. ID

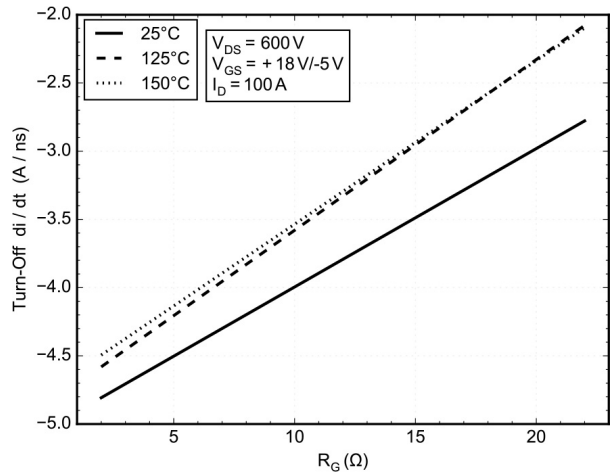

Figure 27. di/dt OFF vs. R_G

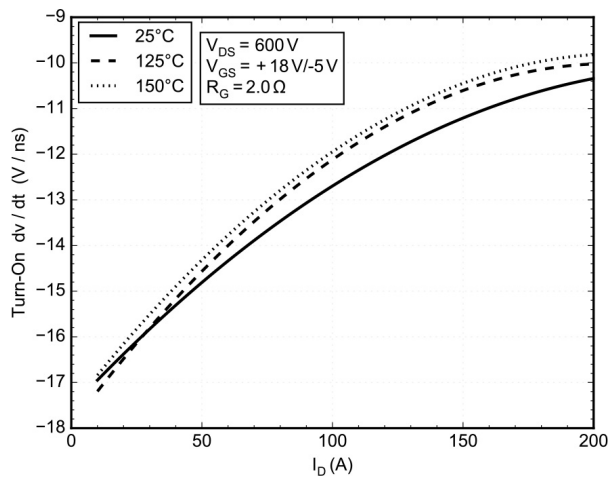

Figure 28. dv/dt ON vs. ID

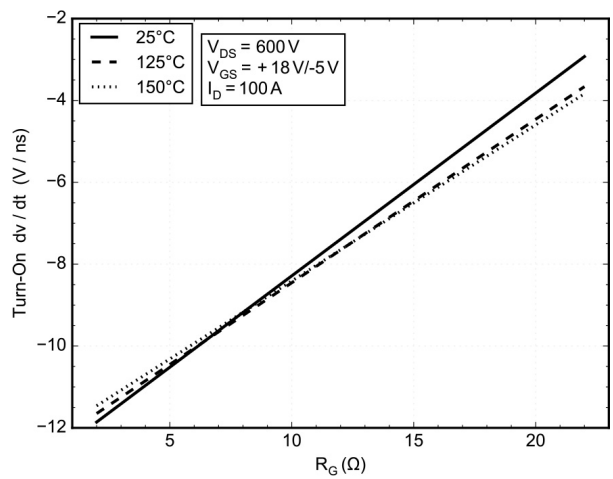

Figure 29. dv/dt ON vs. R_G

**NXH010P120MNF1PTNG, NXH010P120MNF1PNG, NXH010P120MNF1PTG,
NXH010P120MNF1PG**

TYPICAL CHARACTERISTICS

M1/M2 MOSFET SWITCHING CHARACTERISTICS

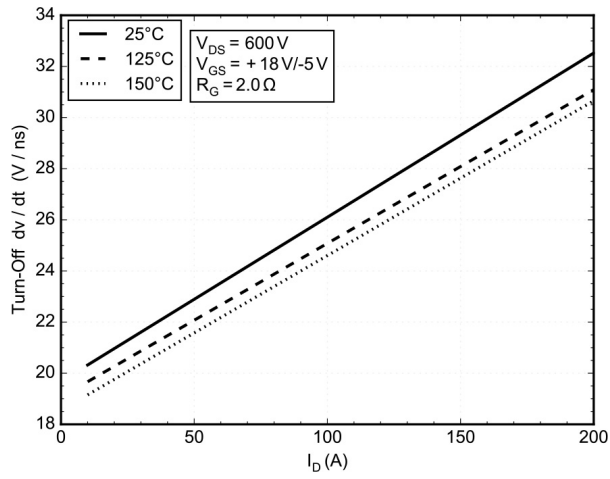

Figure 30. dv/dt OFF vs ID

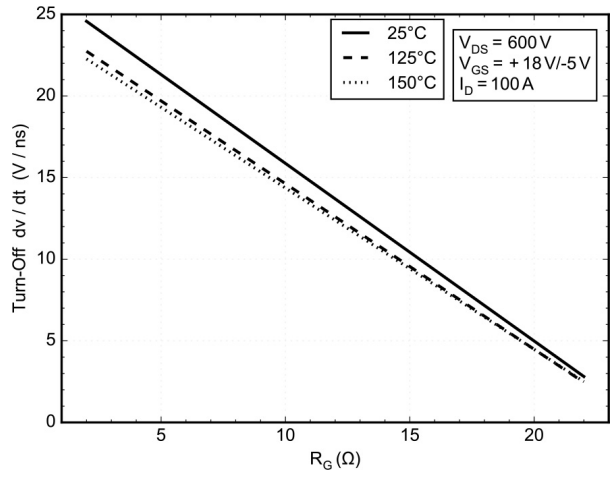
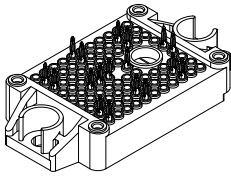

Figure 31. dv/dt OFF vs. RG

MECHANICAL CASE OUTLINE

PACKAGE DIMENSIONS



PIM18 33.8x42.5 (PRESS FIT) CASE 180BW ISSUE B

DATE 30 APR 2021

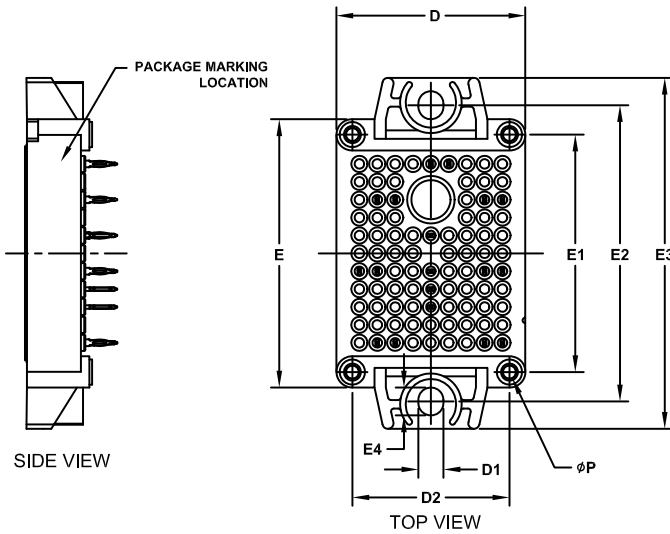

NOTES:

1. CONTROLLING DIMENSION: MILLIMETERS
2. PIN POSITION TOLERANCE IS $\pm 0.4\text{mm}$

DIM	MILLIMETERS		
	MIN.	NOM.	MAX.
A	11.65	12.00	12.35
A1	16.00	16.50	17.00
A2	0.00	0.35	0.60
A3	12.85	13.35	13.85
b	1.15	1.20	1.25
b1	0.59	0.64	0.69
D	33.50	33.80	34.10
D1	4.40	4.50	4.60
D2	27.95	28.10	28.25
E	47.70	48.00	48.30
E1	42.35	42.50	42.65
E2	52.90	53.00	53.10
E3	62.30	62.80	63.30
E4	4.90	5.00	5.10
P	2.20	2.30	2.40

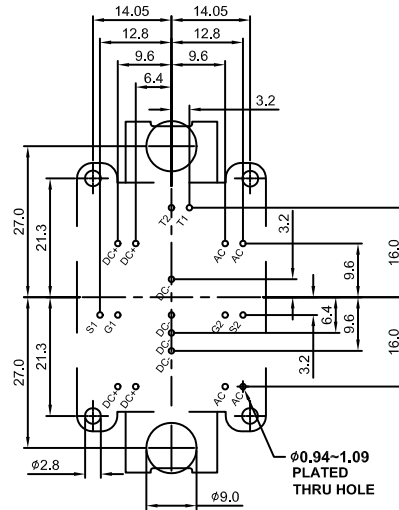
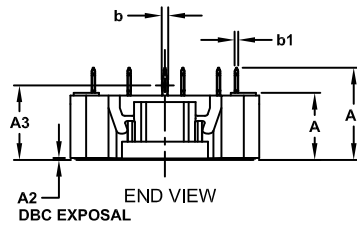

GENERIC MARKING DIAGRAM*

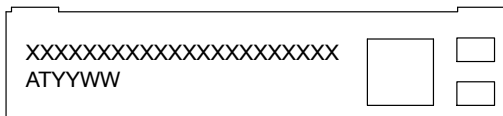

XXXXX = Specific Device Code
AT = Assembly & Test Site Code
YYWW = Year and Work Week Code

This information is generic. Please refer to device data sheet for actual part marking. Pb-Free indicator, "G" or microdot "", may or may not be present. Some products may not follow the Generic Marking.

DOCUMENT NUMBER:	98AON19723H	Electronic versions are uncontrolled except when accessed directly from the Document Repository. Printed versions are uncontrolled except when stamped "CONTROLLED COPY" in red.
DESCRIPTION:	PIM18 33.8x42.5 (PRESS FIT)	PAGE 1 OF 1

onsemi and ONSEMI are trademarks of Semiconductor Components Industries, LLC dba onsemi or its subsidiaries in the United States and/or other countries. onsemi reserves the right to make changes without further notice to any products herein. onsemi makes no warranty, representation or guarantee regarding the suitability of its products for any particular purpose, nor does onsemi assume any liability arising out of the application or use of any product or circuit, and specifically disclaims any and all liability, including without limitation special, consequential or incidental damages. onsemi does not convey any license under its patent rights nor the rights of others.

onsemi, **Onsemi**, and other names, marks, and brands are registered and/or common law trademarks of Semiconductor Components Industries, LLC dba "**onsemi**" or its affiliates and/or subsidiaries in the United States and/or other countries. **onsemi** owns the rights to a number of patents, trademarks, copyrights, trade secrets, and other intellectual property. A listing of **onsemi**'s product/patent coverage may be accessed at www.onsemi.com/site/pdf/Patent-Marking.pdf. **onsemi** reserves the right to make changes at any time to any products or information herein, without notice. The information herein is provided "as-is" and **onsemi** makes no warranty, representation or guarantee regarding the accuracy of the information, product features, availability, functionality, or suitability of its products for any particular purpose, nor does **onsemi** assume any liability arising out of the application or use of any product or circuit, and specifically disclaims any and all liability, including without limitation special, consequential or incidental damages. Buyer is responsible for its products and applications using **onsemi** products, including compliance with all laws, regulations and safety requirements or standards, regardless of any support or applications information provided by **onsemi**. "Typical" parameters which may be provided in **onsemi** data sheets and/or specifications can and do vary in different applications and actual performance may vary over time. All operating parameters, including "Typicals" must be validated for each customer application by customer's technical experts. **onsemi** does not convey any license under any of its intellectual property rights nor the rights of others. **onsemi** products are not designed, intended, or authorized for use as a critical component in life support systems or any FDA Class 3 medical devices or medical devices with a same or similar classification in a foreign jurisdiction or any devices intended for implantation in the human body. Should Buyer purchase or use **onsemi** products for any such unintended or unauthorized application, Buyer shall indemnify and hold **onsemi** and its officers, employees, subsidiaries, affiliates, and distributors harmless against all claims, costs, damages, and expenses, and reasonable attorney fees arising out of, directly or indirectly, any claim of personal injury or death associated with such unintended or unauthorized use, even if such claim alleges that **onsemi** was negligent regarding the design or manufacture of the part. **onsemi** is an Equal Opportunity/Affirmative Action Employer. This literature is subject to all applicable copyright laws and is not for resale in any manner.

ADDITIONAL INFORMATION

TECHNICAL PUBLICATIONS:

Technical Library: www.onsemi.com/design/resources/technical-documentation
onsemi Website: www.onsemi.com

ONLINE SUPPORT: www.onsemi.com/support

For additional information, please contact your local Sales Representative at www.onsemi.com/support/sales