

MOSFET – Small Signal, Single P-Channel, XLLGA3 -30 V, -130 mA



ON Semiconductor®

www.onsemi.com

NTNS41006PZ

Features

- Single P-Channel MOSFET
- Ultra Small and Thin Package (0.62 x 0.62 x 0.4 mm)
- Low $R_{DS(on)}$ Solution in 0.62 x 0.62 mm Package
- These Devices are Pb-Free, Halogen Free/BFR Free and are RoHS Compliant

Applications

- Small Signal Load Switch
- Analog Switch
- High Speed Interfacing
- Optimized for Power Management in Ultra Portable Products

MAXIMUM RATINGS ($T_J = 25^\circ\text{C}$ unless otherwise stated)

Parameter		Symbol	Value	Units	
Drain-to-Source Voltage		V_{DSS}	-30	V	
Gate-to-Source Voltage		V_{GS}	± 20	V	
Continuous Drain Current (Note 1)	Steady State	$T_A = 25^\circ\text{C}$	I_D	-137	mA
				$T_A = 85^\circ\text{C}$	
	$t \leq 5 \text{ s}$	$T_A = 25^\circ\text{C}$	-148		
Power Dissipation (Note 1)	Steady State	$T_A = 25^\circ\text{C}$	P_D	121	mW
				$T_A = 25^\circ\text{C}$	
Pulsed Drain Current		$t_p = 10 \mu\text{s}$	I_{DM}	-550	mA
Operating Junction and Storage Temperature		T_J, T_{STG}	-55 to 150		$^\circ\text{C}$
Source Current (Body Diode)		I_S	-137		mA
Lead Temperature for Soldering Purposes (1/8" from case for 10 s)		T_L	260		$^\circ\text{C}$

Stresses exceeding those listed in the Maximum Ratings table may damage the device. If any of these limits are exceeded, device functionality should not be assumed, damage may occur and reliability may be affected.

THERMAL RESISTANCE RATINGS

Parameter	Symbol	Max	Units
Junction-to-Ambient – Steady State (Note 1)	$R_{\theta JA}$	1035	$^\circ\text{C}/\text{W}$
Junction-to-Ambient – $t \leq 5 \text{ s}$ (Note 1)	$R_{\theta JA}$	895	

1. Surface Mounted on FR4 Board using the minimum recommended pad size, (or 2 mm²), 1 oz Cu.
2. Pulse Test: pulse width $\leq 300 \mu\text{s}$, duty cycle $\leq 2\%$.

MOSFET

$V_{(BR)DSS}$	$R_{DS(on)}$ MAX	I_D MAX
-30 V	4.0 Ω @ -10 V	-130 mA
	7.0 Ω @ -4.5 V	

P-Channel MOSFET

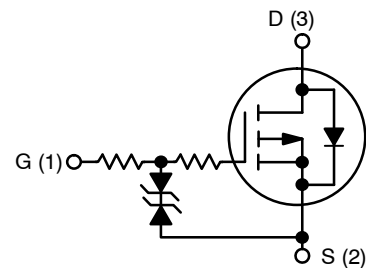

MARKING DIAGRAM



XLLGA3
CASE 713AA

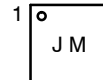

J = Specific Device Code
M = Date Code

ORDERING INFORMATION

Device	Package	Shipping†
NTNS41006PZTCG	XLLGA3 (Pb-Free)	8000 / Tape & Reel

†For information on tape and reel specifications, including part orientation and tape sizes, please refer to our Tape and Reel Packaging Specifications Brochure, BRD8011/D.

NTNS41006PZ

ELECTRICAL CHARACTERISTICS (T_J = 25°C unless otherwise specified)

Parameter	Symbol	Test Condition	Min	Typ	Max	Units
-----------	--------	----------------	-----	-----	-----	-------

OFF CHARACTERISTICS

Drain-to-Source Breakdown Voltage	V _{(BR)DSS}	V _{GS} = 0 V, I _D = -250 μA	-30			V
Drain-to-Source Breakdown Voltage Temperature Coefficient	V _{(BR)DSS} /T _J	I _D = -250 μA, ref to 25°C		32		mV/°C
Zero Gate Voltage Drain Current	I _{DSS}	V _{GS} = 0 V, V _{DS} = -24 V			-1.0	μA
Gate-to-Source Leakage Current	I _{GSS}	V _{DS} = 0 V, V _{GS} = ±12 V			±2.0	μA

ON CHARACTERISTICS (Note 3)

Gate Threshold Voltage	V _{GS(TH)}	V _{GS} = V _{DS} , I _D = -250 μA	-1.0		-3.0	V
Negative Threshold Temperature Coefficient	V _{GS(TH)} /T _J			4.0		mV/°C
Drain-to-Source On Resistance	R _{DS(on)}	V _{GS} = -10 V, I _D = -100 mA		2.1	4.0	Ω
		V _{GS} = -4.5 V, I _D = -50 mA		3.3	7.0	
Forward Transconductance	g _{FS}	V _{DS} = -5 V, I _D = -50 mA		0.14		S
Source-Drain Diode Voltage	V _{SD}	V _{GS} = 0 V, I _S = -50 mA		-0.8	-1.0	V

CHARGES & CAPACITANCES

Input Capacitance	C _{ISS}	V _{GS} = 0 V, f = 10 kHz, V _{DS} = -15 V		9.1		pF
Output Capacitance	C _{OSS}			3.2		
Reverse Transfer Capacitance	C _{RSS}			1.9		
Total Gate Charge	Q _{G(TOT)}	V _{GS} = -10 V, V _{DS} = -15 V, I _D = -100 mA		1.4		nC
Total Gate Charge	Q _{G(TOT)}	V _{GS} = -4.5 V, V _{DS} = -15 V, I _D = -100 mA		0.7		nC
Threshold Gate Charge	Q _{G(TH)}			0.3		
Gate-to-Source Charge	Q _{GS}			0.4		
Gate-to-Drain Charge	Q _{GD}			0.1		

SWITCHING CHARACTERISTICS, V_{GS} = -10 V (Note 3)

Turn-On Delay Time	t _{d(ON)}	V _{GS} = -10 V, V _{DD} = -15 V, I _D = -100 mA, R _G = 2 Ω		22.5		ns
Rise Time	t _r			33.1		
Turn-Off Delay Time	t _{d(OFF)}			178.9		
Fall Time	t _f			101.3		

SWITCHING CHARACTERISTICS, V_{GS} = -4.5 V (Note 3)

Turn-On Delay Time	t _{d(ON)}	V _{GS} = -4.5 V, V _{DD} = -15 V, I _D = -100 mA, R _G = 2 Ω		58.7		ns
Rise Time	t _r			137.3		
Turn-Off Delay Time	t _{d(OFF)}			78.6		
Fall Time	t _f			99.7		

Product parametric performance is indicated in the Electrical Characteristics for the listed test conditions, unless otherwise noted. Product performance may not be indicated by the Electrical Characteristics if operated under different conditions.

3. Switching characteristics are independent of operating junction temperatures.

NTNS41006PZ

TYPICAL CHARACTERISTICS

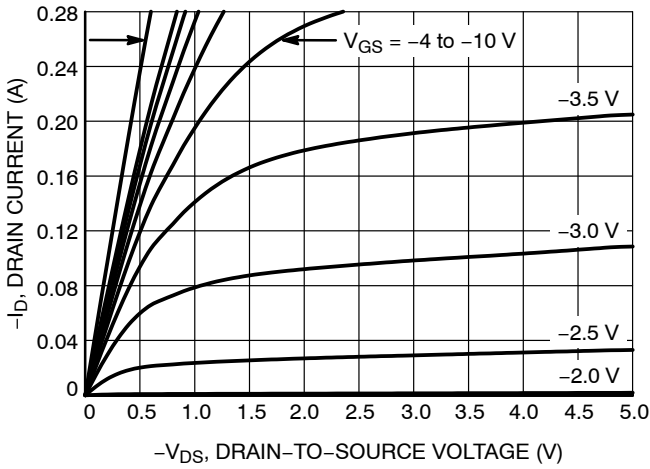

Figure 1. On-Region Characteristics

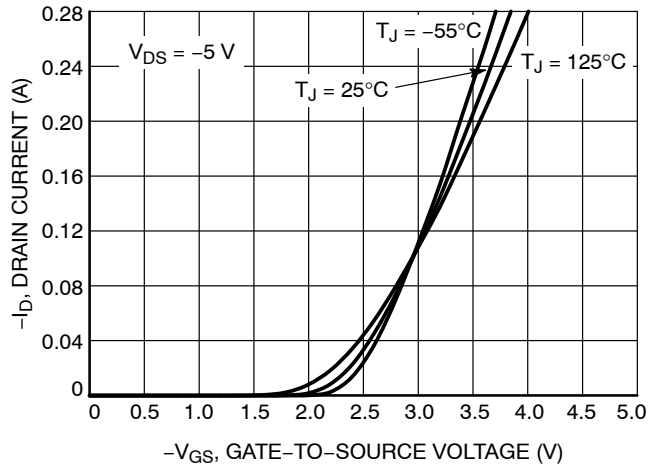

Figure 2. Transfer Characteristics

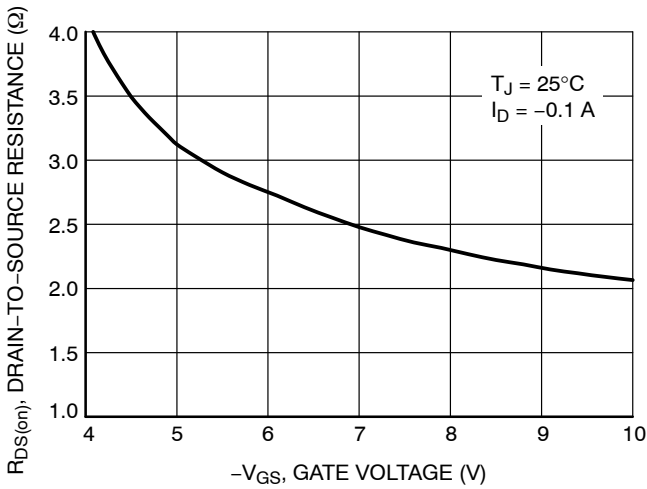

Figure 3. On-Resistance vs. Gate-to-Source Voltage

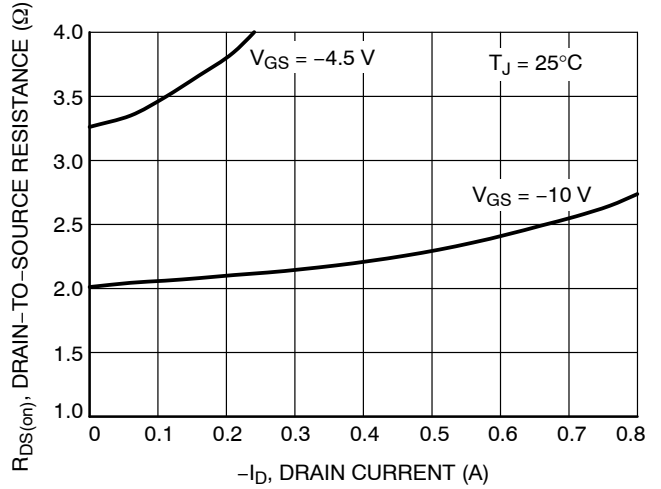

Figure 4. On-Resistance vs. Drain Current and Gate Voltage

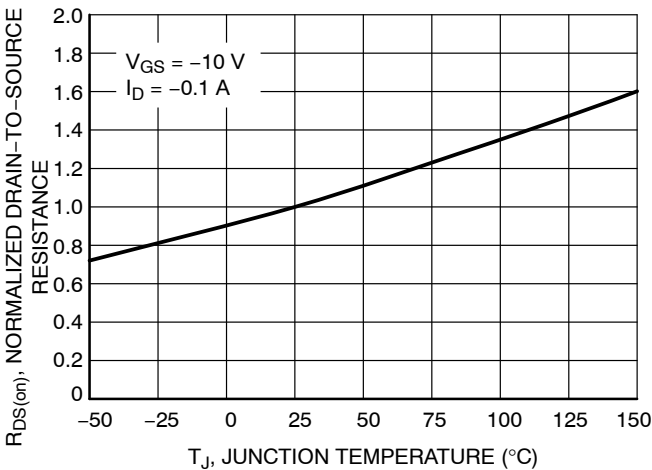

Figure 5. On-Resistance Variation with Temperature

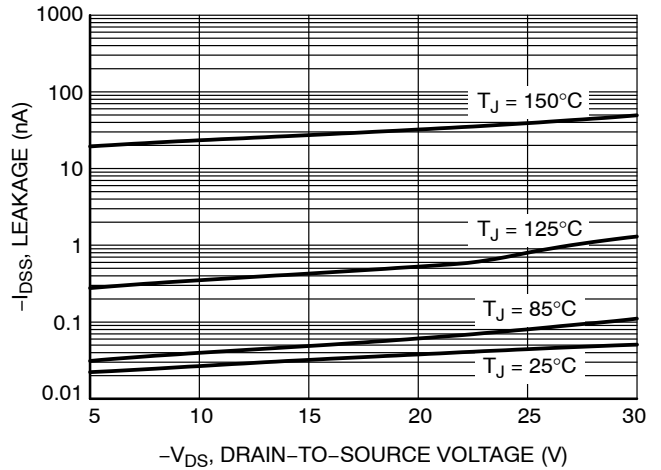

Figure 6. Drain-to-Source Leakage Current vs. Voltage

NTNS41006PZ

TYPICAL CHARACTERISTICS

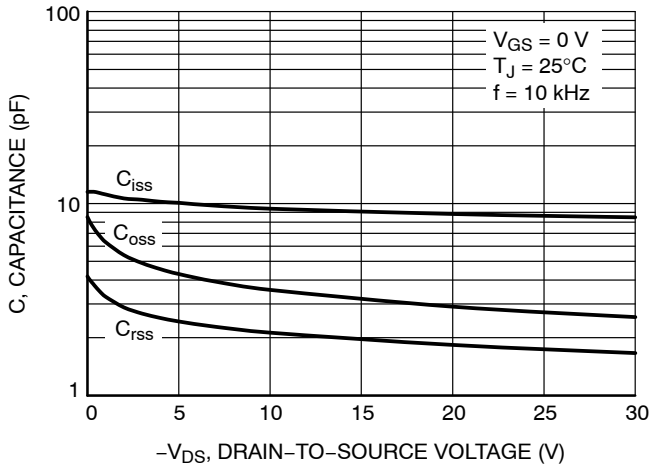

Figure 7. Capacitance Variation

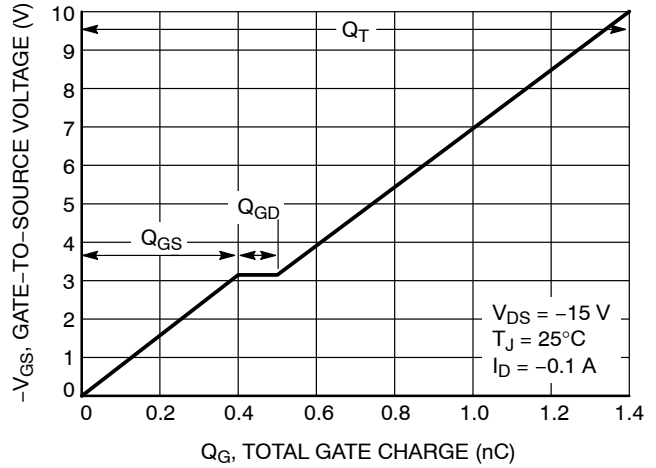

Figure 8. Gate-to-Source vs. Total Charge

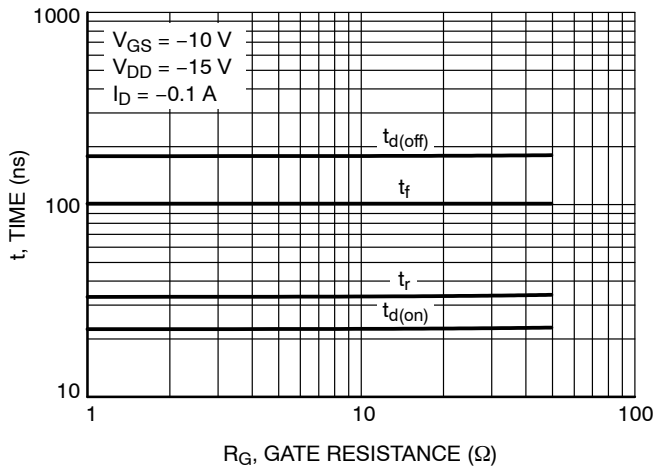

Figure 9. Resistive Switching Time Variation vs. Gate Resistance

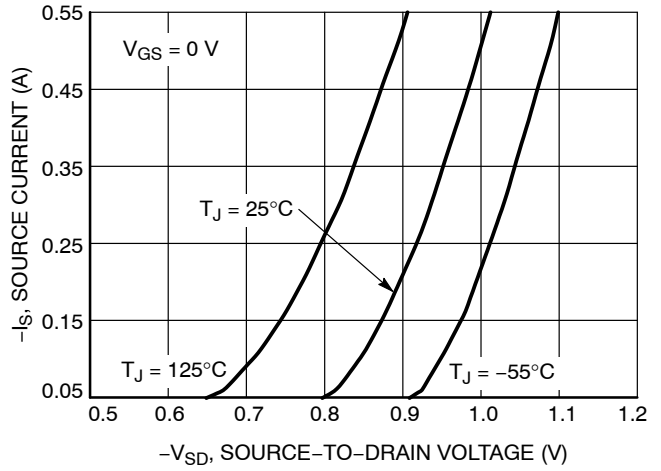

Figure 10. Diode Forward Voltage vs. Current

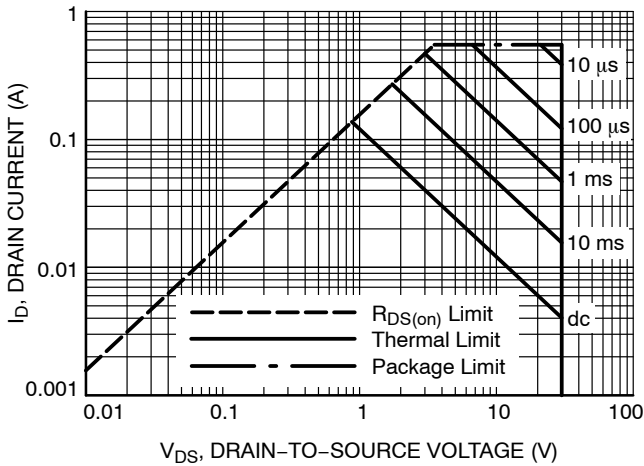

Figure 11. Maximum Rated Forward Biased Safe Operating Area

NTNS41006PZ

TYPICAL CHARACTERISTICS

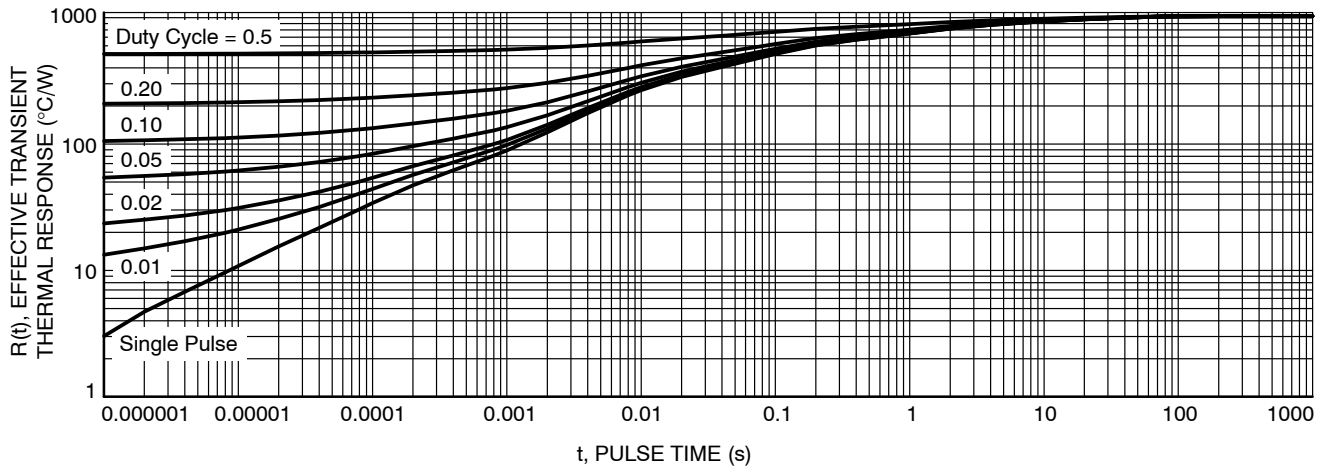

Figure 12. FET Thermal Response



SCALE 8:1

XLLGA3, 0.62x0.62, 0.35P
CASE 713AA
ISSUE D

DATE 12 MAR 2021

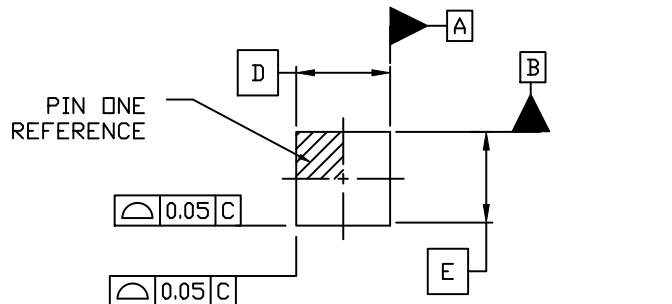

TOP VIEW

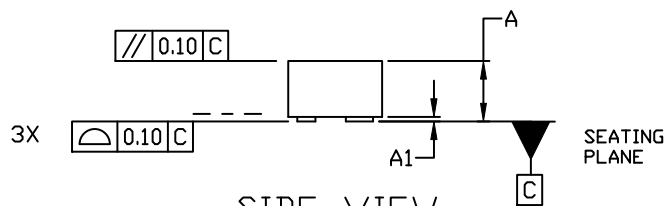

SIDE VIEW

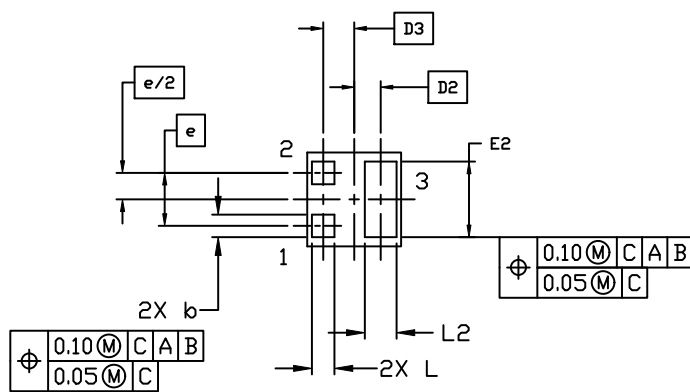

BOTTOM VIEW

NOTES:

1. DIMENSIONING AND TOLERANCING PER ASME Y14.5M, 1994.
2. CONTROLLING DIMENSION: MILLIMETERS

DIM	MILLIMETERS		
	MIN.	NOM.	MAX.
A	0.34	0.39	0.43
A1	0.000	---	0.03
b	0.10	0.15	0.20
D	0.57	0.62	0.67
D2	0.175 BSC		
D3	0.205 BSC		
E	0.57	0.62	0.67
E2	0.40	0.50	0.60
e	0.350 BSC		
k	0.200 REF		
L	0.09	0.15	0.21
L2	0.11	0.21	0.31

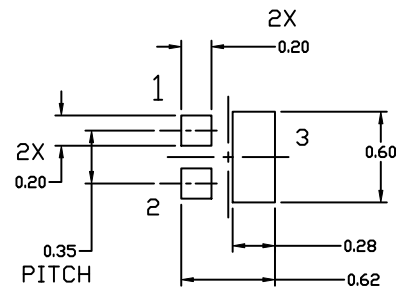

RECOMMENDED MOUNTING FOOTPRINT

* For additional information on our Pb-Free strategy and soldering details, please download the DN Semiconductor Soldering and Mounting Techniques Reference Manual, SOLDERM/D.

GENERIC MARKING DIAGRAM*



X = Specific Device Code
M = Date Code

*This information is generic. Please refer to device data sheet for actual part marking. Pb-Free indicator, "G" or microdot "μ", may or may not be present. Some products may not follow the Generic Marking.

DOCUMENT NUMBER:	98AON67527E	Electronic versions are uncontrolled except when accessed directly from the Document Repository. Printed versions are uncontrolled except when stamped "CONTROLLED COPY" in red.
DESCRIPTION:	XLLGA3, 0.62x0.62, 0.35P	PAGE 1 OF 1

onsemi and ONSEMI are trademarks of Semiconductor Components Industries, LLC dba onsemi or its subsidiaries in the United States and/or other countries. onsemi reserves the right to make changes without further notice to any products herein. onsemi makes no warranty, representation or guarantee regarding the suitability of its products for any particular purpose, nor does onsemi assume any liability arising out of the application or use of any product or circuit, and specifically disclaims any and all liability, including without limitation special, consequential or incidental damages. onsemi does not convey any license under its patent rights nor the rights of others.

onsemi, **Onsemi**, and other names, marks, and brands are registered and/or common law trademarks of Semiconductor Components Industries, LLC dba "**onsemi**" or its affiliates and/or subsidiaries in the United States and/or other countries. **onsemi** owns the rights to a number of patents, trademarks, copyrights, trade secrets, and other intellectual property. A listing of **onsemi**'s product/patent coverage may be accessed at www.onsemi.com/site/pdf/Patent-Marking.pdf. **onsemi** reserves the right to make changes at any time to any products or information herein, without notice. The information herein is provided "as-is" and **onsemi** makes no warranty, representation or guarantee regarding the accuracy of the information, product features, availability, functionality, or suitability of its products for any particular purpose, nor does **onsemi** assume any liability arising out of the application or use of any product or circuit, and specifically disclaims any and all liability, including without limitation special, consequential or incidental damages. Buyer is responsible for its products and applications using **onsemi** products, including compliance with all laws, regulations and safety requirements or standards, regardless of any support or applications information provided by **onsemi**. "Typical" parameters which may be provided in **onsemi** data sheets and/or specifications can and do vary in different applications and actual performance may vary over time. All operating parameters, including "Typicals" must be validated for each customer application by customer's technical experts. **onsemi** does not convey any license under any of its intellectual property rights nor the rights of others. **onsemi** products are not designed, intended, or authorized for use as a critical component in life support systems or any FDA Class 3 medical devices or medical devices with a same or similar classification in a foreign jurisdiction or any devices intended for implantation in the human body. Should Buyer purchase or use **onsemi** products for any such unintended or unauthorized application, Buyer shall indemnify and hold **onsemi** and its officers, employees, subsidiaries, affiliates, and distributors harmless against all claims, costs, damages, and expenses, and reasonable attorney fees arising out of, directly or indirectly, any claim of personal injury or death associated with such unintended or unauthorized use, even if such claim alleges that **onsemi** was negligent regarding the design or manufacture of the part. **onsemi** is an Equal Opportunity/Affirmative Action Employer. This literature is subject to all applicable copyright laws and is not for resale in any manner.

ADDITIONAL INFORMATION

TECHNICAL PUBLICATIONS:

Technical Library: www.onsemi.com/design/resources/technical-documentation
onsemi Website: www.onsemi.com

ONLINE SUPPORT: www.onsemi.com/support

For additional information, please contact your local Sales Representative at www.onsemi.com/support/sales