

MOSFET - Power, Single N-Channel, DFNW8, DUAL COOL®

80 V, 1.56 mΩ, 287 A
NTMTSC1D5N08MC

Features

- Small Footprint (8x8 mm) for Compact Design
- Low $R_{DS(on)}$ to Minimize Conduction Losses
- Low Q_G and Capacitance to Minimize Driver Losses
- These Devices are Pb-Free, Halogen Free/BFR Free and are RoHS Compliant

Typical Applications

- Power Tools, Battery Operated Vacuums
- UAV/Drones, Material Handling
- BMS/Storage, Home Automation

MAXIMUM RATINGS ($T_J = 25^\circ\text{C}$ unless otherwise noted)

| Parameter | Symbol | Value | Unit |
|--|----------------|-------------|------------------|
| Drain-to-Source Voltage | V_{DSS} | 80 | V |
| Gate-to-Source Voltage | V_{GS} | ± 20 | V |
| Continuous Drain Current $R_{\theta JC}$ (Note 2) | I_D | 287 | A |
| Power Dissipation $R_{\theta JC}$ (Note 2) | | | |
| Continuous Drain Current $R_{\theta JA}$ (Notes 1, 2) | I_D | 33 | A |
| Power Dissipation $R_{\theta JA}$ (Notes 1, 2) | | | |
| Pulsed Drain Current | I_{DM} | 3500 | A |
| Operating Junction and Storage Temperature Range | T_J, T_{stg} | -55 to +150 | $^\circ\text{C}$ |
| Single Pulse Drain-to-Source Avalanche Energy ($I_{L(pk)} = 31\text{ A}, L = 3\text{ mH}$) | E_{AS} | 1441 | mJ |
| Lead Temperature for Soldering Purposes (1/8" from case for 10 s) | T_L | 260 | $^\circ\text{C}$ |

Stresses exceeding those listed in the Maximum Ratings table may damage the device. If any of these limits are exceeded, device functionality should not be assumed, damage may occur and reliability may be affected.

THERMAL RESISTANCE MAXIMUM RATINGS

| Parameter | Symbol | Value | Unit |
|--|-----------------|-------|---------------------------|
| Junction-to-Case - Steady State (Note 2) | $R_{\theta JC}$ | 0.5 | $^\circ\text{C}/\text{W}$ |
| Junction-to-Top Source - Steady State (Note 2) | $R_{\theta JC}$ | 0.8 | |
| Junction-to-Ambient - Steady State (Note 2) | $R_{\theta JA}$ | 38 | |

1. Surface-mounted on FR4 board using a 1 in² pad size, 1 oz. Cu pad.
2. The entire application environment impacts the thermal resistance values shown, they are not constants and are only valid for the particular conditions noted.

| $V_{(BR)DSS}$ | $R_{DS(ON)} \text{ MAX}$ | $I_D \text{ MAX}$ |
|---------------|--------------------------|-------------------|
| 80 V | 1.56 mΩ @ 10 V | 287 A |
| | 4.0 mΩ @ 6 V | |

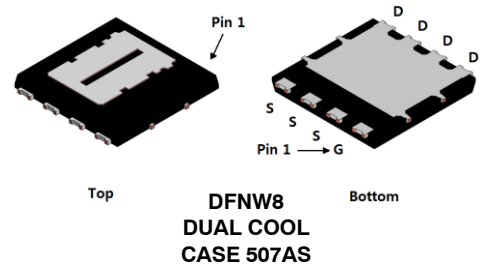
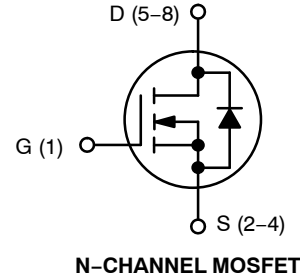

MARKING DIAGRAM

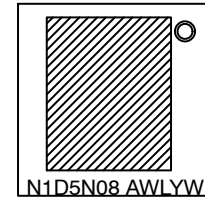

N1D5N08 = Specific Device Code
A = Assembly Location
WL = 2-digit Wafer Lot Code
Y = Year Code
W = Work Week Code

ORDERING INFORMATION

See detailed ordering, marking and shipping information in the package dimensions section on page 5 of this data sheet.

NTMTSC1D5N08MC

ELECTRICAL CHARACTERISTICS ($T_J = 25^\circ\text{C}$ unless otherwise specified)

| Parameter | Symbol | Test Condition | Min | Typ | Max | Unit |
|---|-------------------|--|---------------------------|-----|-----------|----------------------|
| OFF CHARACTERISTICS | | | | | | |
| Drain-to-Source Breakdown Voltage | $V_{(BR)DSS}$ | $V_{GS} = 0\text{ V}, I_D = 250\ \mu\text{A}$ | 80 | | | V |
| Drain-to-Source Breakdown Voltage Temperature Coefficient | $V_{(BR)DSS}/T_J$ | $I_D = 250\ \mu\text{A}$, ref to 25°C | | 82 | | mV/ $^\circ\text{C}$ |
| Zero Gate Voltage Drain Current | I_{DSS} | $V_{GS} = 0\text{ V}, V_{DS} = 80\text{ V}$ | $T_J = 25^\circ\text{C}$ | | 1 | μA |
| | | | $T_J = 125^\circ\text{C}$ | | 250 | |
| Gate-to-Source Leakage Current | I_{GSS} | $V_{DS} = 0\text{ V}, V_{GS} = \pm 20\text{ V}$ | | | ± 100 | nA |

ON CHARACTERISTICS (Note 3)

| | | | | | | |
|--|------------------|--|-----|------|------|----------------------|
| Gate Threshold Voltage | $V_{GS(TH)}$ | $V_{GS} = V_{DS}, I_D = 650\ \mu\text{A}$ | 2.0 | 3.0 | 4.0 | V |
| Negative Threshold Temperature Coefficient | $V_{GS(TH)}/T_J$ | $I_D = 650\ \mu\text{A}$, ref to 25°C | | -8.3 | | mV/ $^\circ\text{C}$ |
| Drain-to-Source On Resistance | $R_{DS(on)}$ | $V_{GS} = 10\text{ V}, I_D = 80\text{ A}$ | | 1.10 | 1.56 | m Ω |
| Drain-to-Source On Resistance | $R_{DS(on)}$ | $V_{GS} = 6\text{ V}, I_D = 58\text{ A}$ | | 1.75 | 4.0 | m Ω |
| Forward Transconductance | g_{FS} | $V_{DS} = 5\text{ V}, I_D = 80\text{ A}$ | | 219 | | S |
| Gate Resistance | R_G | $T_A = 25^\circ\text{C}$ | | 0.9 | | Ω |

CHARGES, CAPACITANCES & GATE RESISTANCE

| | | | | | | |
|------------------------------|---------------|---|--|------|--------|----|
| Input Capacitance | C_{ISS} | $V_{GS} = 0\text{ V}, f = 1\text{ MHz}, V_{DS} = 40\text{ V}$ | | 7420 | 10,400 | pF |
| Output Capacitance | C_{OSS} | | | 2555 | 3600 | |
| Reverse Transfer Capacitance | C_{RSS} | | | 101 | 175 | |
| Total Gate Charge | $Q_{G(TOT)}$ | $V_{GS} = 10\text{ V}, V_{DS} = 40\text{ V}; I_D = 80\text{ A}$ | | 101 | 140 | nC |
| Threshold Gate Charge | $Q_{G(TH)}$ | | | 20 | 28 | |
| Gate-to-Source Charge | Q_{GS} | | | 32 | | |
| Gate-to-Drain Charge | Q_{GD} | | | 21 | | |
| Output Charge | Q_{OSS} | | | 141 | | |
| Sync Charge | Q_{sync} | | | 82 | | |
| Plateau Voltage | $V_{plateau}$ | | | 5 | | |

SWITCHING CHARACTERISTICS, $V_{GS} = 10\text{ V}$ (Note 3)

| | | | | | | |
|---------------------|--------------|--|--|----|--|----|
| Turn-On Delay Time | $t_{d(ON)}$ | $V_{GS} = 10\text{ V}, V_{DS} = 40\text{ V}, I_D = 80\text{ A}, R_G = 6\ \Omega$ | | 30 | | ns |
| Rise Time | t_r | | | 24 | | |
| Turn-Off Delay Time | $t_{d(OFF)}$ | | | 69 | | |
| Fall Time | t_f | | | 31 | | |

DRAIN-SOURCE DIODE CHARACTERISTICS

| | | | | | | |
|-------------------------|----------|--|--|-----|-----|----|
| Forward Diode Voltage | V_{SD} | $V_{GS} = 0\text{ V}, I_S = 2\text{ A}$ | | 0.7 | 1.2 | V |
| | | $V_{GS} = 0\text{ V}, I_S = 80\text{ A}$ | | 0.8 | 1.3 | |
| Reverse Recovery Time | t_{RR} | $I_F = 40\text{ A}, di/dt = 300\text{ A}/\mu\text{s}$ | | 39 | 62 | ns |
| Reverse Recovery Charge | Q_{RR} | | | 89 | 142 | nC |
| Reverse Recovery Time | t_{RR} | $I_F = 40\text{ A}, di/dt = 1000\text{ A}/\mu\text{s}$ | | 31 | 50 | ns |
| Reverse Recovery Charge | Q_{RR} | | | 209 | 335 | nC |

Product parametric performance is indicated in the Electrical Characteristics for the listed test conditions, unless otherwise noted. Product performance may not be indicated by the Electrical Characteristics if operated under different conditions.

3. Switching characteristics are independent of operating junction temperatures.

TYPICAL CHARACTERISTICS

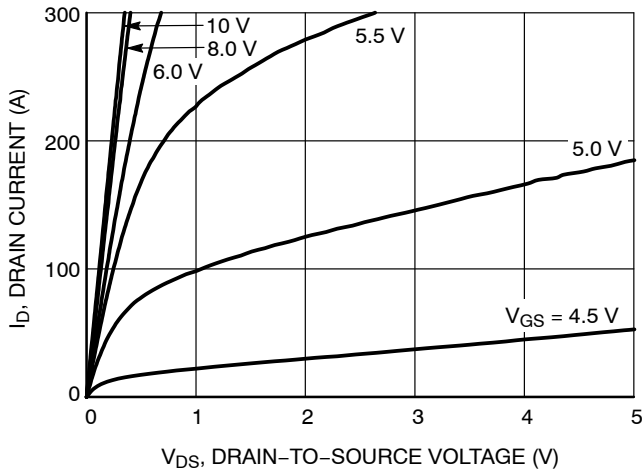

Figure 1. On-Region Characteristics

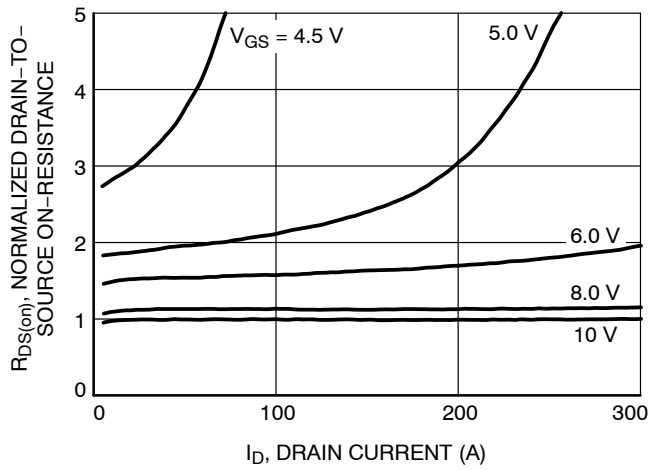

Figure 2. Normalized On-Resistance vs. Drain Current and Gate Voltage

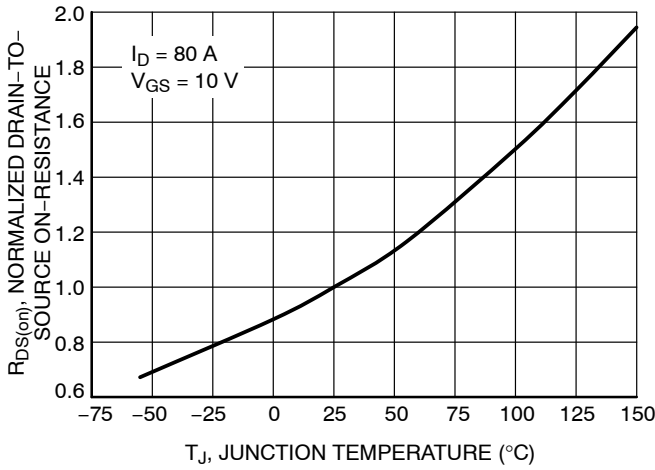

Figure 3. Normalized On Resistance vs. Junction Temperature

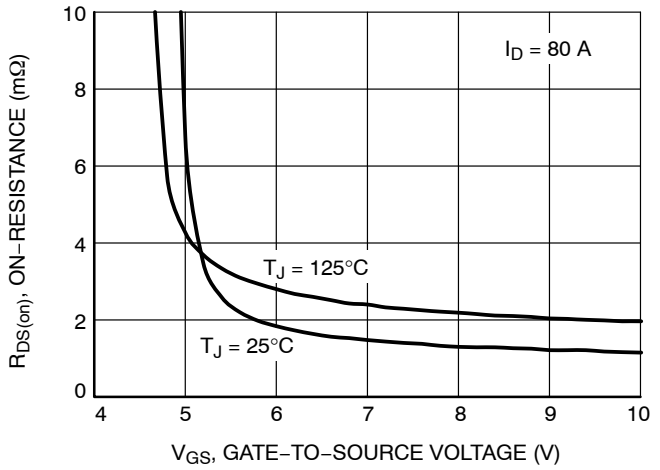

Figure 4. On-Resistance vs. Gate-to-Source Voltage

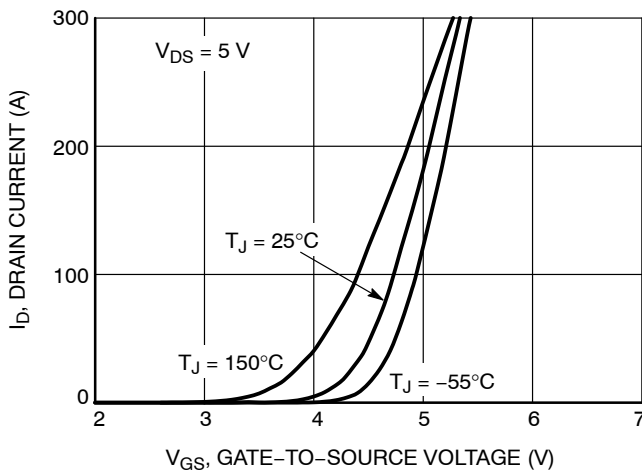

Figure 5. Transfer Characteristics

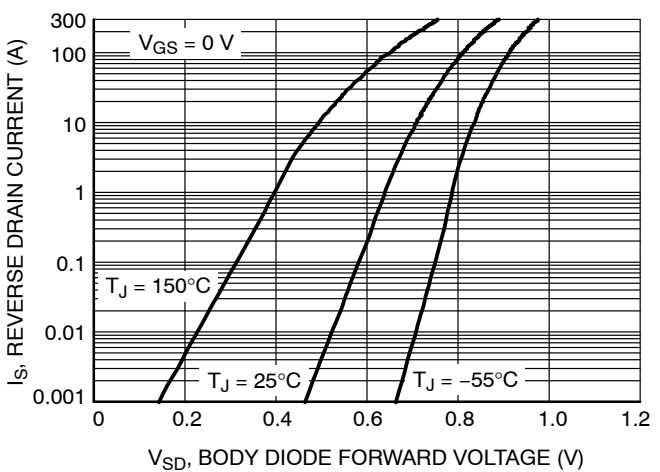

Figure 6. Source-to-Drain Diode Forward Voltage vs. Source Current

NTMTSC1D5N08MC

TYPICAL CHARACTERISTICS

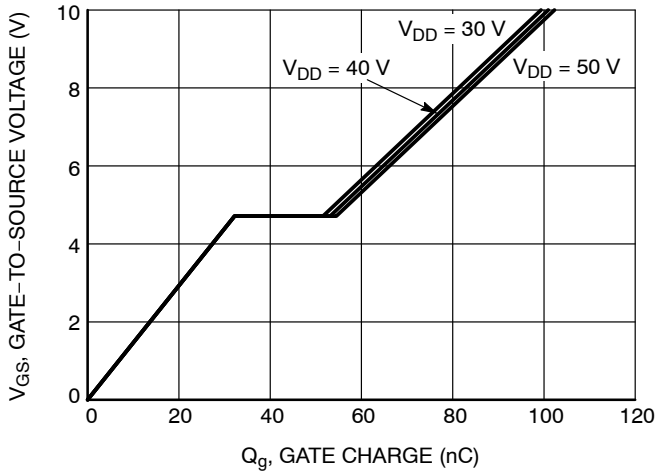

Figure 7. Gate Charge Characteristics

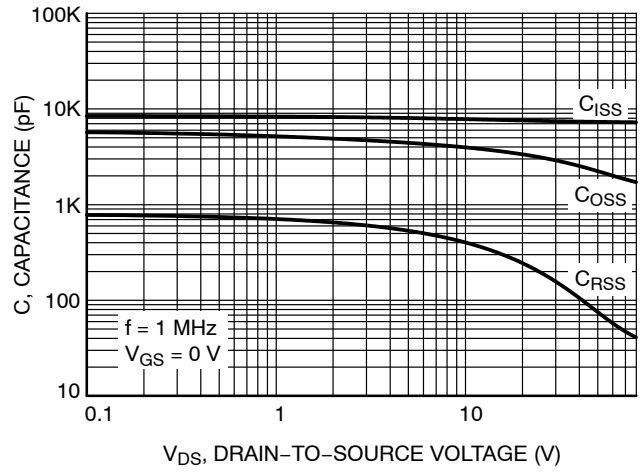

Figure 8. Capacitance vs. Drain-to-Source Voltage

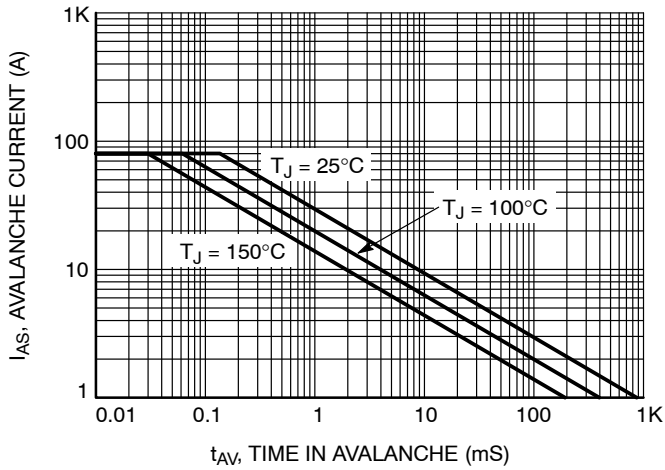

Figure 9. Unclamped Inductive Switching Capability

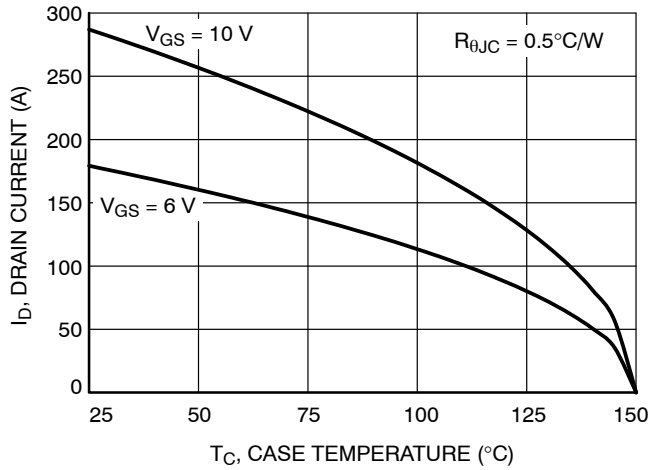

Figure 10. Maximum Continuous Drain Current vs. Case Temperature

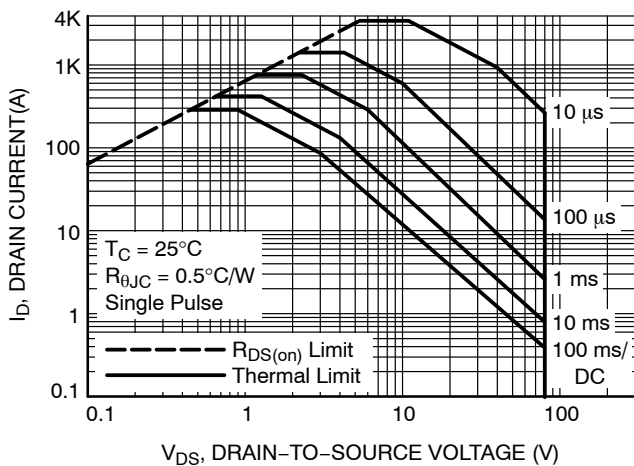

Figure 11. Forward Biased Safe Operating Area

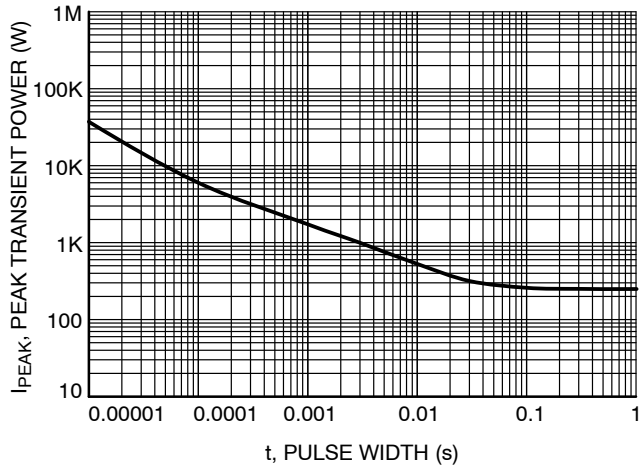

Figure 12. Single Pulse Maximum Power Dissipation

NTMTSC1D5N08MC

TYPICAL CHARACTERISTICS

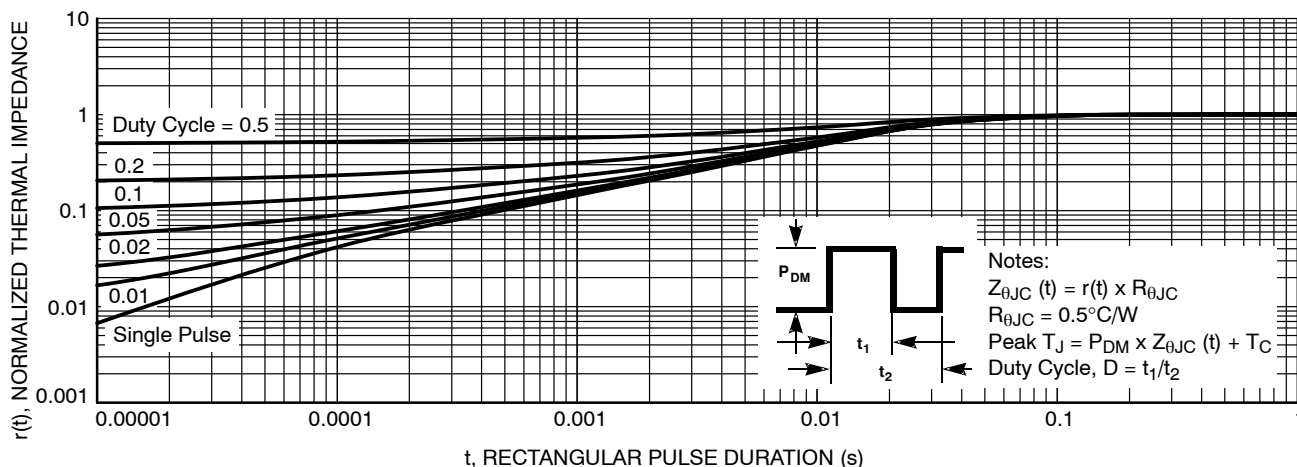

Figure 13. Transient Thermal Impedance

DEVICE ORDERING INFORMATION

| Device | Marking | Package | Shipping† |
|----------------|---------|------------------------------|--------------------|
| NTMTSC1D5N08MC | N1D5N08 | DFNW8 DUAL COOL (Pb-Free) | 3000 / Tape & Reel |

†For information on tape and reel specifications, including part orientation and tape sizes, please refer to our Tape and Reel Packaging Specifications Brochure, BRD8011/D.

MECHANICAL CASE OUTLINE

PACKAGE DIMENSIONS

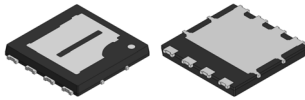

TDFNW8 8.30x8.40x0.92, 2.00P
CASE 507AS
ISSUE C

DATE 28 MAY 2024

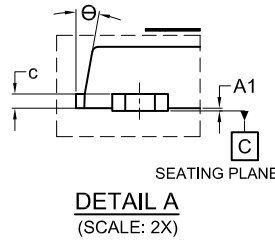
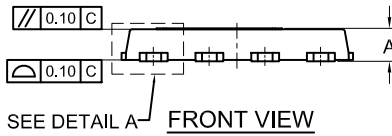
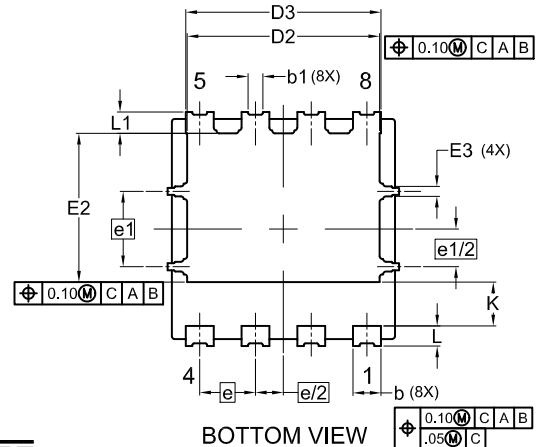
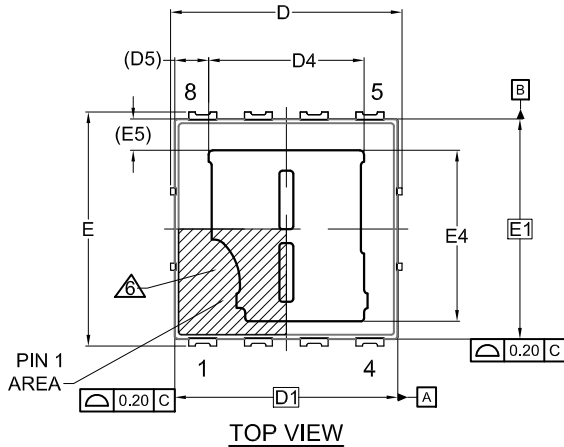

NOTES:

1. DIMENSIONING & TOLERANCING PER ASME Y14.5M, 2009.
2. CONTROLLING DIMENSION: MILLIMETERS
3. COPLANARITY APPLIES TO THE EXPOSED PADS AS WELL AS THE TERMINALS.
4. DIMENSIONS D1 AND E1 DO NOT INCLUDE MOLD FLASH, PROTRUSIONS, OR GATE BURRS.
5. SEATING PLANE IS DEFINED BY THE TERMINALS. "A1" IS DEFINED AS THE DISTANCE FROM THE SEATING PLANE TO THE LOWEST POINT ON THE PACKAGE BODY.
6. SLOT PARTITION IS OPTIONAL.

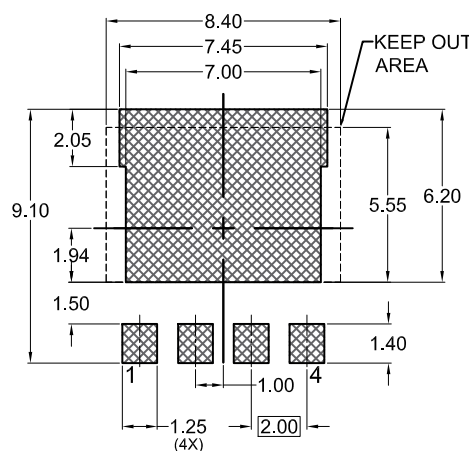
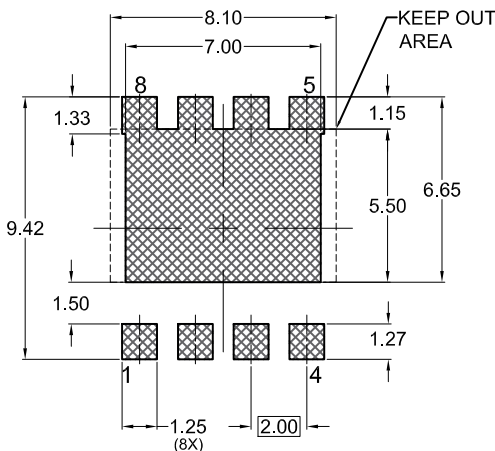

RECOMMENDED LAND PATTERN

*FOR ADDITIONAL INFORMATION ON OUR PB-FREE STRATEGY AND SOLDERING DETAILS, PLEASE DOWNLOAD THE ONSEMI SOLDERING AND MOUNTING TECHNIQUES REFERENCE MANUAL, SOLDERRM/D.

UNIVERSAL LAND PATTERN*

| DIM | MILLIMETERS | | |
|------|-------------|------|------|
| | MIN. | NOM. | MAX. |
| A | 0.82 | 0.92 | 1.02 |
| A1 | 0.00 | — | 0.05 |
| b | 0.90 | 1.00 | 1.10 |
| b1 | 0.35 | 0.45 | 0.55 |
| c | 0.23 | 0.28 | 0.33 |
| D | 8.20 | 8.30 | 8.40 |
| D1 | 8.00 BSC | | |
| D2 | 6.80 | 6.90 | 7.00 |
| D3 | 6.90 | 7.00 | 7.10 |
| D4 | 5.52 | 5.67 | 5.82 |
| D5 | 1.16 REF | | |
| E | 8.30 | 8.40 | 8.50 |
| E1 | 7.90 BSC | | |
| E2 | 5.24 | 5.34 | 5.44 |
| E3 | 0.25 | 0.35 | 0.45 |
| E4 | 6.08 | 6.23 | 6.38 |
| E5 | 1.13 REF | | |
| e | 2.00 BSC | | |
| e/2 | 1.00 BSC | | |
| e1 | 2.70 BSC | | |
| e1/2 | 1.35 BSC | | |
| K | 1.50 | 1.57 | 1.70 |
| L | 0.64 | 0.74 | 0.84 |
| L1 | 0.67 | 0.77 | 0.87 |
| Θ | 0° | — | 12° |

| | | |
|-------------------------|-------------------------------------|--|
| DOCUMENT NUMBER: | 98AON95716G | Electronic versions are uncontrolled except when accessed directly from the Document Repository. Printed versions are uncontrolled except when stamped "CONTROLLED COPY" in red. |
| DESCRIPTION: | TDFNW8 8.30x8.40x0.92, 2.00P | PAGE 1 OF 2 |

onsemi and ONSEMI are trademarks of Semiconductor Components Industries, LLC dba onsemi or its subsidiaries in the United States and/or other countries. onsemi reserves the right to make changes without further notice to any products herein. onsemi makes no warranty, representation or guarantee regarding the suitability of its products for any particular purpose, nor does onsemi assume any liability arising out of the application or use of any product or circuit, and specifically disclaims any and all liability, including without limitation special, consequential or incidental damages. onsemi does not convey any license under its patent rights nor the rights of others.

TDFNW8 8.30x8.40x0.92, 2.00P
CASE 507AS
ISSUE C

DATE 28 MAY 2024

GENERIC MARKING DIAGRAM*

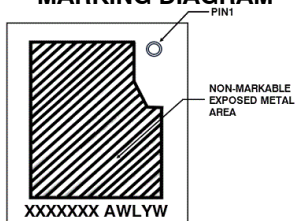

XXXX = Specific Device Code
 A = Assembly Location
 WL = Wafer Lot Code
 Y = Year Code
 W = Work Week Code

*This information is generic. Please refer to device data sheet for actual part marking. Pb-Free indicator, "G" or microdot "•", may or may not be present. Some products may not follow the Generic Marking.

| | | |
|-------------------------|-------------------------------------|--|
| DOCUMENT NUMBER: | 98AON95716G | Electronic versions are uncontrolled except when accessed directly from the Document Repository. Printed versions are uncontrolled except when stamped "CONTROLLED COPY" in red. |
| DESCRIPTION: | TDFNW8 8.30x8.40x0.92, 2.00P | PAGE 2 OF 2 |

onsemi and onsemi are trademarks of Semiconductor Components Industries, LLC dba onsemi or its subsidiaries in the United States and/or other countries. onsemi reserves the right to make changes without further notice to any products herein. onsemi makes no warranty, representation or guarantee regarding the suitability of its products for any particular purpose, nor does onsemi assume any liability arising out of the application or use of any product or circuit, and specifically disclaims any and all liability, including without limitation special, consequential or incidental damages. onsemi does not convey any license under its patent rights nor the rights of others.

www.onsemi.com

onsemi, **Onsemi**, and other names, marks, and brands are registered and/or common law trademarks of Semiconductor Components Industries, LLC dba "**onsemi**" or its affiliates and/or subsidiaries in the United States and/or other countries. **onsemi** owns the rights to a number of patents, trademarks, copyrights, trade secrets, and other intellectual property. A listing of **onsemi**'s product/patent coverage may be accessed at www.onsemi.com/site/pdf/Patent-Marking.pdf. **onsemi** reserves the right to make changes at any time to any products or information herein, without notice. The information herein is provided "as-is" and **onsemi** makes no warranty, representation or guarantee regarding the accuracy of the information, product features, availability, functionality, or suitability of its products for any particular purpose, nor does **onsemi** assume any liability arising out of the application or use of any product or circuit, and specifically disclaims any and all liability, including without limitation special, consequential or incidental damages. Buyer is responsible for its products and applications using **onsemi** products, including compliance with all laws, regulations and safety requirements or standards, regardless of any support or applications information provided by **onsemi**. "Typical" parameters which may be provided in **onsemi** data sheets and/or specifications can and do vary in different applications and actual performance may vary over time. All operating parameters, including "Typicals" must be validated for each customer application by customer's technical experts. **onsemi** does not convey any license under any of its intellectual property rights nor the rights of others. **onsemi** products are not designed, intended, or authorized for use as a critical component in life support systems or any FDA Class 3 medical devices or medical devices with a same or similar classification in a foreign jurisdiction or any devices intended for implantation in the human body. Should Buyer purchase or use **onsemi** products for any such unintended or unauthorized application, Buyer shall indemnify and hold **onsemi** and its officers, employees, subsidiaries, affiliates, and distributors harmless against all claims, costs, damages, and expenses, and reasonable attorney fees arising out of, directly or indirectly, any claim of personal injury or death associated with such unintended or unauthorized use, even if such claim alleges that **onsemi** was negligent regarding the design or manufacture of the part. **onsemi** is an Equal Opportunity/Affirmative Action Employer. This literature is subject to all applicable copyright laws and is not for resale in any manner.

ADDITIONAL INFORMATION

TECHNICAL PUBLICATIONS:

Technical Library: www.onsemi.com/design/resources/technical-documentation
onsemi Website: www.onsemi.com

ONLINE SUPPORT: www.onsemi.com/support

For additional information, please contact your local Sales Representative at www.onsemi.com/support/sales