

NTB6413AN, NTP6413AN, NVB6413AN



ON Semiconductor®

www.onsemi.com

MOSFET – Power, N-Channel 100 V, 42 A, 28 mΩ

Features

- Low $R_{DS(on)}$
- High Current Capability
- 100% Avalanche Tested
- NVB Prefix for Automotive and Other Applications Requiring Unique Site and Control Change Requirements; AEC-Q101 Qualified and PPAP Capable
- These Devices are Pb-Free and are RoHS Compliant

MAXIMUM RATINGS ($T_J = 25^\circ\text{C}$ Unless otherwise specified)

| Parameter | Symbol | Value | Unit | |
|---|------------------------|---------------------------|------------------|---|
| Drain-to-Source Voltage | V_{DS} | 100 | V | |
| Gate-to-Source Voltage – Continuous | V_{GS} | ± 20 | V | |
| Continuous Drain Current $R_{\theta JC}$ | Steady State | $T_C = 25^\circ\text{C}$ | I_D 42 | A |
| | | $T_C = 100^\circ\text{C}$ | 28 | |
| Power Dissipation $R_{\theta JC}$ | Steady State | $T_C = 25^\circ\text{C}$ | P_D 136 | W |
| Pulsed Drain Current | $t_p = 10 \mu\text{s}$ | I_{DM} 178 | A | |
| Operating Junction and Storage Temperature Range | T_J, T_{stg} | -55 to +175 | $^\circ\text{C}$ | |
| Source Current (Body Diode) | I_S | 42 | A | |
| Single Pulse Drain-to-Source Avalanche Energy ($V_{DD} = 50 \text{ Vdc}$, $V_{GS} = 10 \text{ Vdc}$, $I_{L(pk)} = 36.5 \text{ A}$, $L = 0.3 \text{ mH}$, $R_G = 25 \Omega$) | E_{AS} | 200 | mJ | |
| Lead Temperature for Soldering Purposes, 1/8" from Case for 10 Seconds | T_L | 260 | $^\circ\text{C}$ | |

THERMAL RESISTANCE RATINGS

| Parameter | Symbol | Max | Unit |
|---------------------------------------|-----------------|-----|--------------------|
| Junction-to-Case (Drain) Steady State | $R_{\theta JC}$ | 1.1 | $^\circ\text{C/W}$ |
| Junction-to-Ambient (Note 1) | $R_{\theta JA}$ | 35 | |

Stresses exceeding those listed in the Maximum Ratings table may damage the device. If any of these limits are exceeded, device functionality should not be assumed, damage may occur and reliability may be affected.

1. Surface mounted on FR4 board using 1 sq in pad size, (Cu Area 1.127 sq in [2 oz] including traces).

| $V_{(BR)DSS}$ | $R_{DS(ON)} \text{ MAX}$ | $I_D \text{ MAX}$ (Note 1) |
|---------------|--------------------------|----------------------------|
| 100 V | 28 mΩ @ 10 V | 42 A |

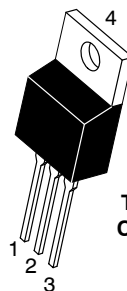
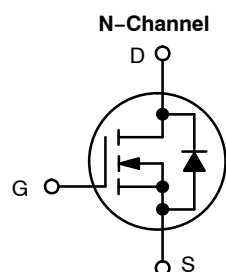

TO-220AB
CASE 221A
STYLE 5

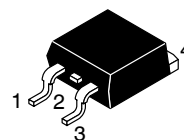

D²PAK
CASE 418B
STYLE 2

MARKING DIAGRAM & PIN ASSIGNMENT

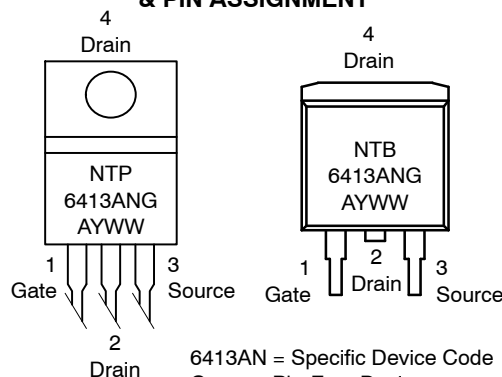

6413AN = Specific Device Code
G = Pb-Free Device
A = Assembly Location
Y = Year
WW = Work Week

ORDERING INFORMATION

See detailed ordering and shipping information in the package dimensions section on page 5 of this data sheet.

NTB6413AN, NTP6413AN, NVB6413AN

ELECTRICAL CHARACTERISTICS (T_J = 25°C Unless otherwise specified)

| Characteristics | Symbol | Test Condition | Min | Typ | Max | Unit |
|-----------------|--------|----------------|-----|-----|-----|------|
|-----------------|--------|----------------|-----|-----|-----|------|

OFF CHARACTERISTICS

| | | | | | | |
|---|--------------------------------------|---|------------------------|-----|------|-------|
| Drain-to-Source Breakdown Voltage | V _{(BR)DSS} | V _{GS} = 0 V, I _D = 250 μA | 100 | | | V |
| Drain-to-Source Breakdown Voltage Temperature Coefficient | V _{(BR)DSS} /T _J | | | 115 | | mV/°C |
| Zero Gate Voltage Drain Current | I _{DSS} | V _{GS} = 0 V, V _{DS} = 100 V | T _J = 25°C | | 1.0 | μA |
| | | | T _J = 125°C | | 100 | |
| Gate-to-Source Leakage Current | I _{GSS} | V _{DS} = 0 V, V _{GS} = ±20 V | | | ±100 | nA |

ON CHARACTERISTICS (Note 2)

| | | | | | | |
|--|-------------------------------------|---|-----|------|-----|-------|
| Gate Threshold Voltage | V _{GS(th)} | V _{GS} = V _{DS} , I _D = 250 μA | 2.0 | | 4.0 | V |
| Negative Threshold Temperature Coefficient | V _{GS(th)} /T _J | | | 8.1 | | mV/°C |
| Drain-to-Source On-Resistance | R _{DS(on)} | V _{GS} = 10 V, I _D = 42 A | | 25.6 | 28 | mΩ |
| Forward Transconductance | g _{FS} | V _{GS} = 5 V, I _D = 20 A | | 17.9 | | S |

CHARGES, CAPACITANCES & GATE RESISTANCE

| | | | | | | |
|------------------------------|---------------------|--|--|------|--|----|
| Input Capacitance | C _{iss} | V _{DS} = 25 V, V _{GS} = 0 V, f = 1 MHz | | 1800 | | pF |
| Output Capacitance | C _{oss} | | | 280 | | |
| Reverse Transfer Capacitance | C _{rss} | | | 100 | | |
| Total Gate Charge | Q _{G(TOT)} | V _{GS} = 10 V, V _{DS} = 80 V, I _D = 42 A | | 51 | | nC |
| Threshold Gate Charge | Q _{G(TH)} | | | 2.0 | | |
| Gate-to-Source Charge | Q _{GS} | | | 10 | | |
| Gate-to-Drain Charge | Q _{GD} | | | 26 | | |
| Plateau Voltage | V _{GP} | | | 5.8 | | V |
| Gate Resistance | R _G | | | 2.4 | | Ω |

SWITCHING CHARACTERISTICS, V_{GS} = 10 V (Note 3)

| | | | | | | |
|---------------------|---------------------|--|--|----|--|----|
| Turn-On Delay Time | t _{d(on)} | V _{GS} = 10 V, V _{DD} = 80 V, I _D = 42 A, R _G = 6.2 Ω | | 13 | | ns |
| Rise Time | t _r | | | 84 | | |
| Turn-Off Delay Time | t _{d(off)} | | | 52 | | |
| Fall Time | t _f | | | 71 | | |

DRAIN-SOURCE DIODE CHARACTERISTICS

| | | | | | | | |
|-------------------------|-----------------|--|------------------------|-----|------|-----|----|
| Forward Diode Voltage | V _{SD} | I _S = 42 A | T _J = 25°C | | 0.92 | 1.3 | V |
| | | | T _J = 125°C | | 0.83 | | |
| Reverse Recovery Time | t _{rr} | V _{GS} = 0 V, I _S = 42 A, dI _{SD} /dt = 100 A/μs | | 73 | | ns | |
| Charge Time | t _a | | | 56 | | | |
| Discharge Time | t _b | | | 17 | | | |
| Reverse Recovery Charge | Q _{RR} | | | 230 | | | nC |

2. Pulse Test: Pulse Width ≤ 300 μs, Duty Cycle ≤ 2%.
3. Switching characteristics are independent of operating junction temperatures.

TYPICAL CHARACTERISTICS

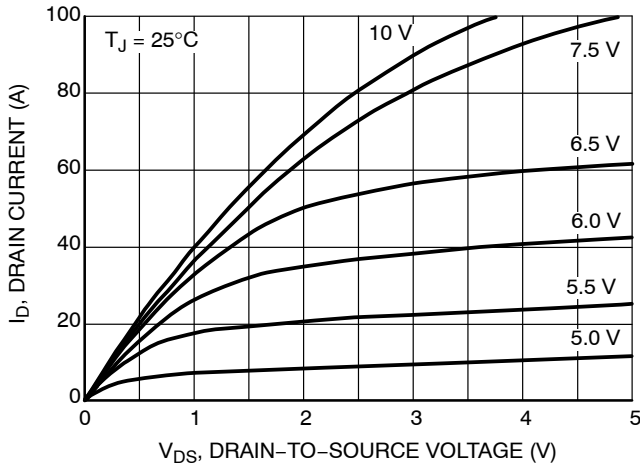

Figure 1. On-Region Characteristics

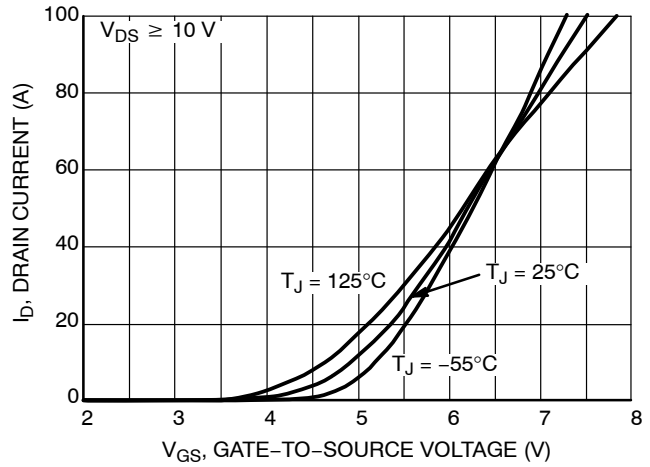

Figure 2. Transfer Characteristics

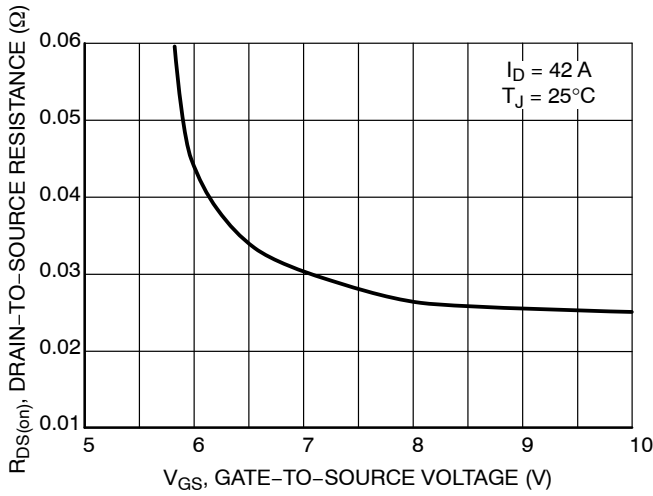

Figure 3. On-Region versus Gate Voltage

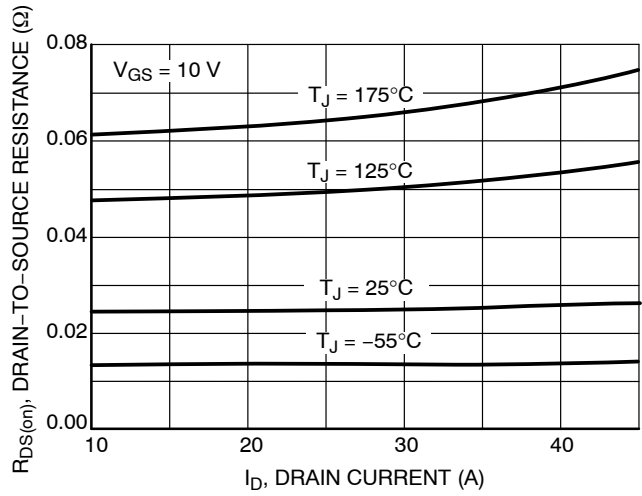

Figure 4. On-Resistance versus Drain Current and Gate Voltage

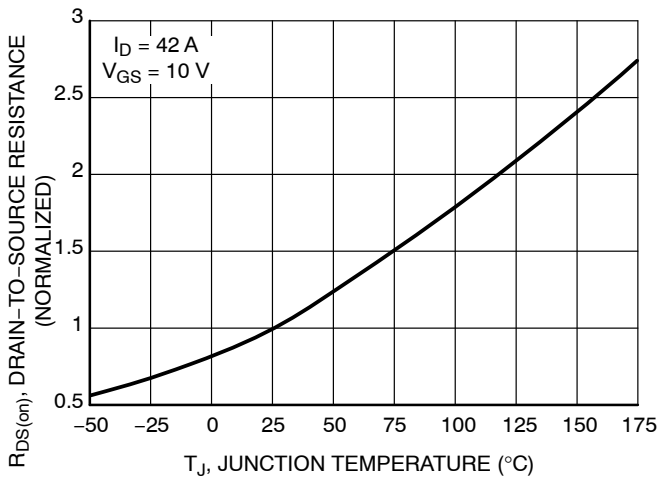

Figure 5. On-Resistance Variation with Temperature

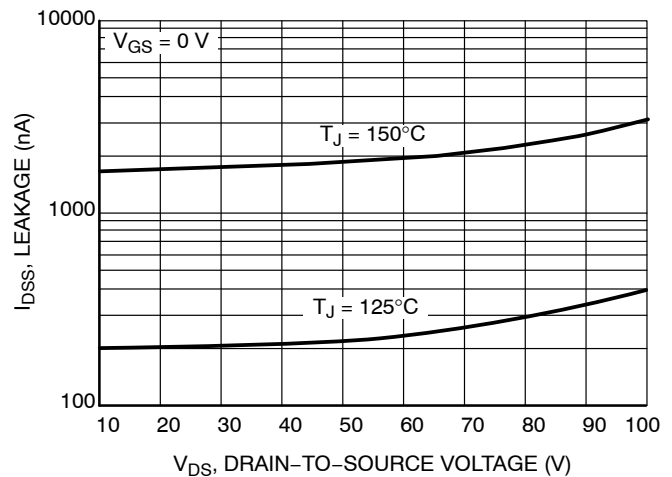

Figure 6. Drain-to-Source Leakage Current versus Voltage

TYPICAL CHARACTERISTICS

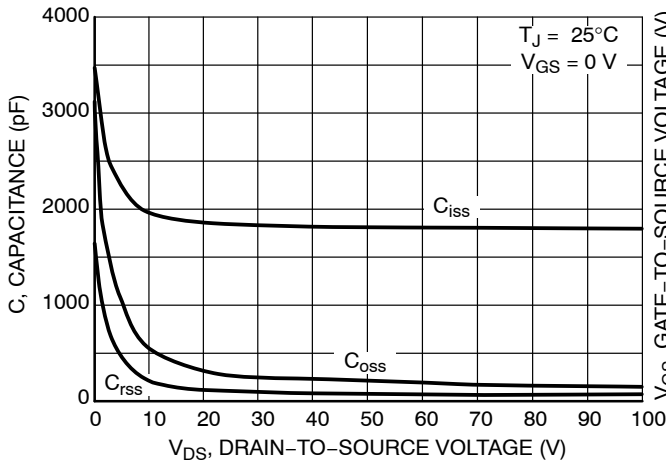

Figure 7. Capacitance Variation

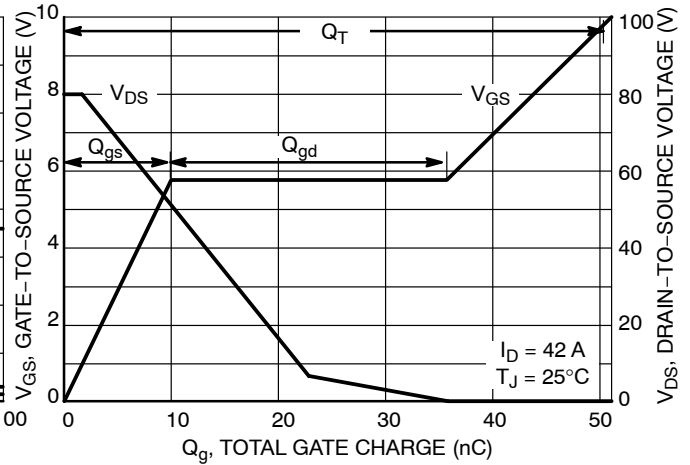

Figure 8. Gate-to-Source Voltage and Drain-to-Source Voltage versus Total Charge

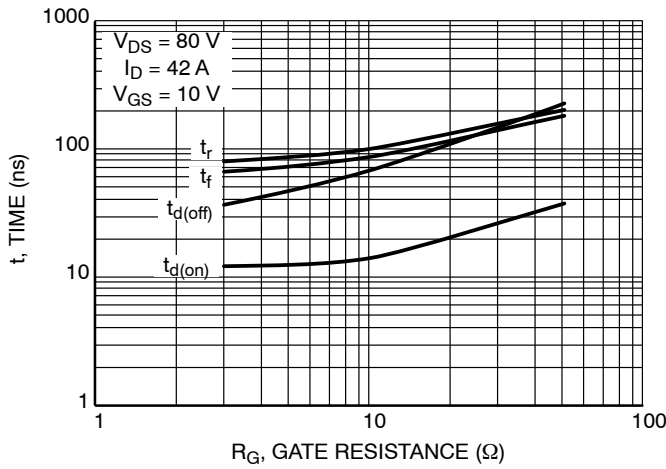

Figure 9. Resistive Switching Time Variation versus Gate Resistance

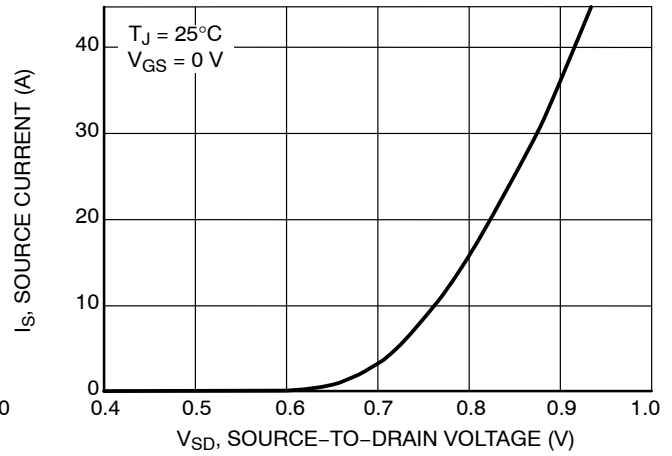

Figure 10. Diode Forward Voltage versus Current

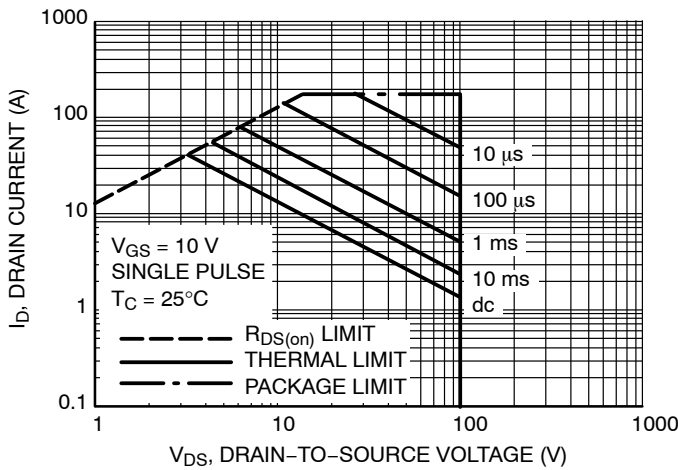

Figure 11. Maximum Rated Forward Biased Safe Operating Area

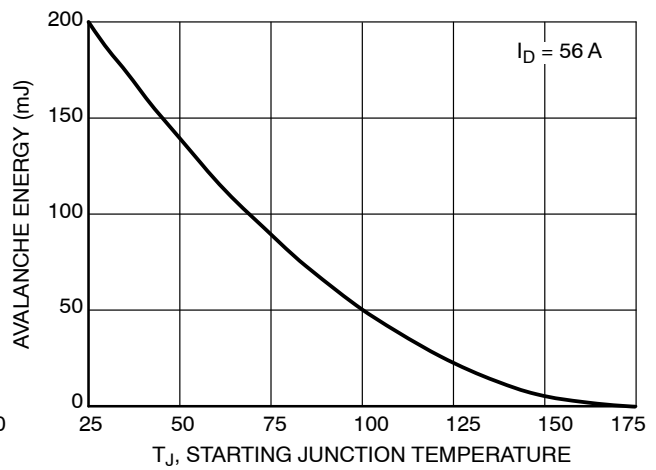

Figure 12. Maximum Avalanche Energy versus Starting Junction Temperature

NTB6413AN, NTP6413AN, NVB6413AN

TYPICAL CHARACTERISTICS

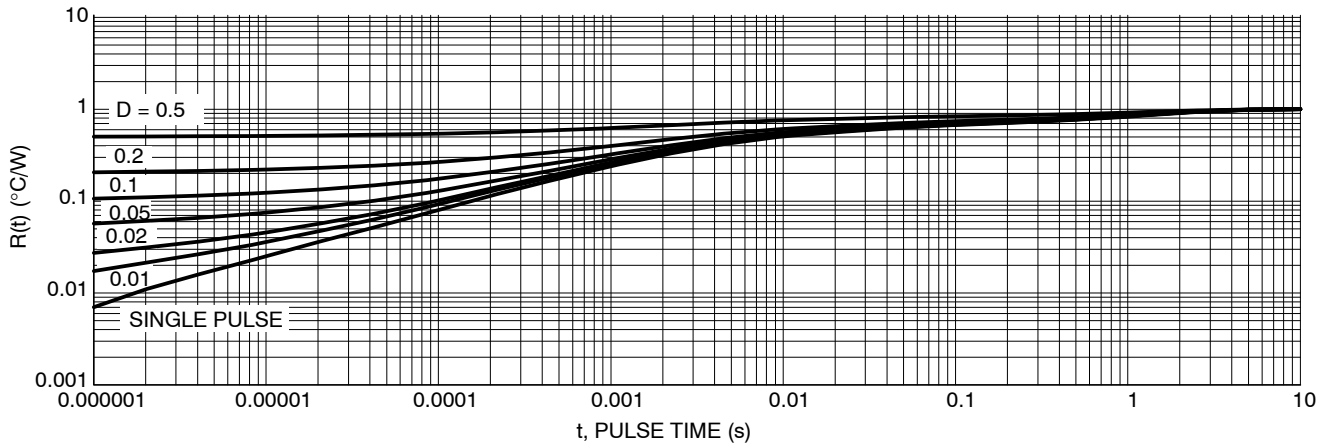
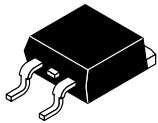

Figure 13. Thermal Response

ORDERING INFORMATION

| Device | Package | Shipping [†] |
|--------------|---------------------------------|-----------------------|
| NTB6413ANG | D ² PAK (Pb-Free) | 50 Units / Rail |
| NTB6413ANT4G | D ² PAK (Pb-Free) | 800 / Tape & Reel |
| NTP6413ANG | TO-220 (Pb-Free) | 50 Units / Rail |
| NVB6413ANT4G | D ² PAK (Pb-Free) | 800 / Tape & Reel |

[†]For information on tape and reel specifications, including part orientation and tape sizes, please refer to our Tape and Reel Packaging Specifications Brochure, BRD8011/D.



D²PAK 3
CASE 418B-04
ISSUE L

DATE 17 FEB 2015

SCALE 1:1

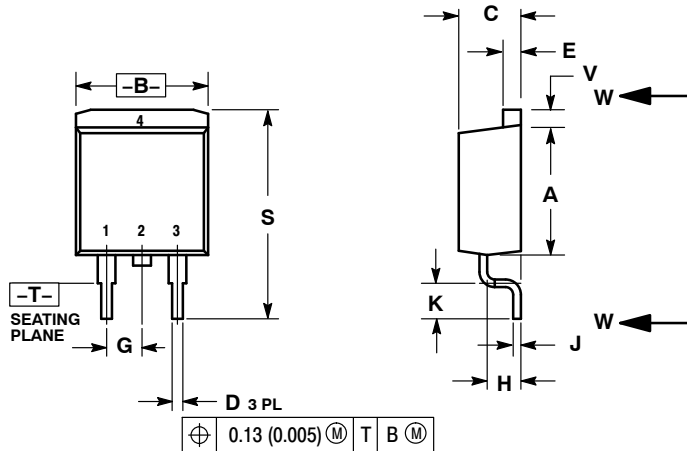

- NOTES:
1. DIMENSIONING AND TOLERANCING PER ANSI Y14.5M, 1982.
 2. CONTROLLING DIMENSION: INCH.
 3. 418B-01 THRU 418B-03 OBSOLETE, NEW STANDARD 418B-04.

| DIM | INCHES | | MILLIMETERS | |
|-----|--------|-------|-------------|-------|
| | MIN | MAX | MIN | MAX |
| A | 0.340 | 0.380 | 8.64 | 9.65 |
| B | 0.380 | 0.405 | 9.65 | 10.29 |
| C | 0.160 | 0.190 | 4.06 | 4.83 |
| D | 0.020 | 0.035 | 0.51 | 0.89 |
| E | 0.045 | 0.055 | 1.14 | 1.40 |
| F | 0.310 | 0.350 | 7.87 | 8.89 |
| G | 0.100 | BSC | 2.54 | BSC |
| H | 0.080 | 0.110 | 2.03 | 2.79 |
| J | 0.018 | 0.025 | 0.46 | 0.64 |
| K | 0.090 | 0.110 | 2.29 | 2.79 |
| L | 0.052 | 0.072 | 1.32 | 1.83 |
| M | 0.280 | 0.320 | 7.11 | 8.13 |
| N | 0.197 | REF | 5.00 | REF |
| P | 0.079 | REF | 2.00 | REF |
| R | 0.039 | REF | 0.99 | REF |
| S | 0.575 | 0.625 | 14.60 | 15.88 |
| V | 0.045 | 0.055 | 1.14 | 1.40 |

VARIABLE CONFIGURATION ZONE

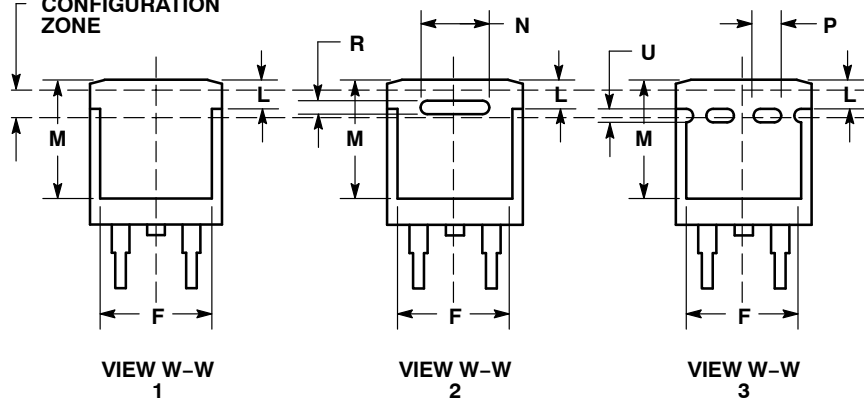

- | | | | | | |
|---|--|--|---|--|---|
| STYLE 1: PIN 1. BASE 2. COLLECTOR 3. EMITTER 4. COLLECTOR | STYLE 2: PIN 1. GATE 2. DRAIN 3. SOURCE 4. DRAIN | STYLE 3: PIN 1. ANODE 2. CATHODE 3. ANODE 4. CATHODE | STYLE 4: PIN 1. GATE 2. COLLECTOR 3. EMITTER 4. COLLECTOR | STYLE 5: PIN 1. CATHODE 2. ANODE 3. CATHODE 4. ANODE | STYLE 6: PIN 1. NO CONNECT 2. CATHODE 3. ANODE 4. CATHODE |
|---|--|--|---|--|---|

MARKING INFORMATION AND FOOTPRINT ON PAGE 2

| | | |
|------------------|----------------------|--|
| DOCUMENT NUMBER: | 98ASB42761B | Electronic versions are uncontrolled except when accessed directly from the Document Repository. Printed versions are uncontrolled except when stamped "CONTROLLED COPY" in red. |
| DESCRIPTION: | D ² PAK 3 | PAGE 1 OF 2 |

onsemi and ONSEMI are trademarks of Semiconductor Components Industries, LLC dba onsemi or its subsidiaries in the United States and/or other countries. onsemi reserves the right to make changes without further notice to any products herein. onsemi makes no warranty, representation or guarantee regarding the suitability of its products for any particular purpose, nor does onsemi assume any liability arising out of the application or use of any product or circuit, and specifically disclaims any and all liability, including without limitation special, consequential or incidental damages. onsemi does not convey any license under its patent rights nor the rights of others.

**GENERIC
MARKING DIAGRAM***

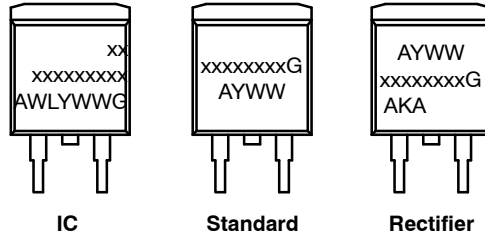

- xx = Specific Device Code
- A = Assembly Location
- WL = Wafer Lot
- Y = Year
- WW = Work Week
- G = Pb-Free Package
- AKA = Polarity Indicator

*This information is generic. Please refer to device data sheet for actual part marking. Pb-Free indicator, "G" or microdot "•", may or may not be present. Some products may not follow the Generic Marking.

SOLDERING FOOTPRINT*

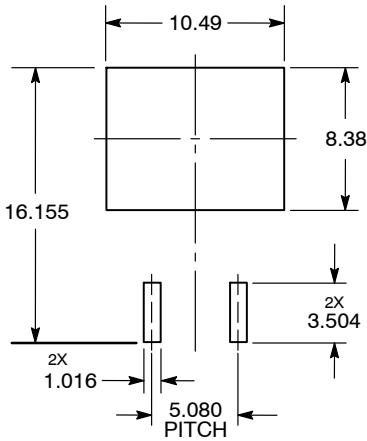

DIMENSIONS: MILLIMETERS

*For additional information on our Pb-Free strategy and soldering details, please download the **onsemi** Soldering and Mounting Techniques Reference Manual, SOLDERRM/D.

| | | |
|-------------------------|---------------------------|---|
| DOCUMENT NUMBER: | 98ASB42761B | Electronic versions are uncontrolled except when accessed directly from the Document Repository. Printed versions are uncontrolled except when stamped "CONTROLLED COPY" in red. |
| DESCRIPTION: | D²PAK 3 | PAGE 2 OF 2 |

onsemi and **ONSEMI** are trademarks of Semiconductor Components Industries, LLC dba **onsemi** or its subsidiaries in the United States and/or other countries. **onsemi** reserves the right to make changes without further notice to any products herein. **onsemi** makes no warranty, representation or guarantee regarding the suitability of its products for any particular purpose, nor does **onsemi** assume any liability arising out of the application or use of any product or circuit, and specifically disclaims any and all liability, including without limitation special, consequential or incidental damages. **onsemi** does not convey any license under its patent rights nor the rights of others.

onsemi, **Onsemi**, and other names, marks, and brands are registered and/or common law trademarks of Semiconductor Components Industries, LLC dba "**onsemi**" or its affiliates and/or subsidiaries in the United States and/or other countries. **onsemi** owns the rights to a number of patents, trademarks, copyrights, trade secrets, and other intellectual property. A listing of **onsemi**'s product/patent coverage may be accessed at www.onsemi.com/site/pdf/Patent-Marking.pdf. **onsemi** reserves the right to make changes at any time to any products or information herein, without notice. The information herein is provided "as-is" and **onsemi** makes no warranty, representation or guarantee regarding the accuracy of the information, product features, availability, functionality, or suitability of its products for any particular purpose, nor does **onsemi** assume any liability arising out of the application or use of any product or circuit, and specifically disclaims any and all liability, including without limitation special, consequential or incidental damages. Buyer is responsible for its products and applications using **onsemi** products, including compliance with all laws, regulations and safety requirements or standards, regardless of any support or applications information provided by **onsemi**. "Typical" parameters which may be provided in **onsemi** data sheets and/or specifications can and do vary in different applications and actual performance may vary over time. All operating parameters, including "Typicals" must be validated for each customer application by customer's technical experts. **onsemi** does not convey any license under any of its intellectual property rights nor the rights of others. **onsemi** products are not designed, intended, or authorized for use as a critical component in life support systems or any FDA Class 3 medical devices or medical devices with a same or similar classification in a foreign jurisdiction or any devices intended for implantation in the human body. Should Buyer purchase or use **onsemi** products for any such unintended or unauthorized application, Buyer shall indemnify and hold **onsemi** and its officers, employees, subsidiaries, affiliates, and distributors harmless against all claims, costs, damages, and expenses, and reasonable attorney fees arising out of, directly or indirectly, any claim of personal injury or death associated with such unintended or unauthorized use, even if such claim alleges that **onsemi** was negligent regarding the design or manufacture of the part. **onsemi** is an Equal Opportunity/Affirmative Action Employer. This literature is subject to all applicable copyright laws and is not for resale in any manner.

ADDITIONAL INFORMATION

TECHNICAL PUBLICATIONS:

Technical Library: www.onsemi.com/design/resources/technical-documentation
onsemi Website: www.onsemi.com

ONLINE SUPPORT: www.onsemi.com/support

For additional information, please contact your local Sales Representative at www.onsemi.com/support/sales