

N-Channel JFET, Dual

-25 V, 20 to 40 mA, 40 mS

NSVJ6904DSB6

The NSVJ6904DSB6 is a composite type of JFET designed for compact size and high efficiency which can achieve high gain performance. This AEC-Q101 qualified and PPAP capable device is suited for automotive applications.

Features

- Large |yfs|
- Small Ciss
- Ultralow Noise Figure
- CPH6 Package is Pin-Compatible with SC-74
- AEC-Q101 Qualified and PPAP Capable
- Mounting Area is Greatly Reduced by Incorporating Two JFETs of the NSVJ3910SB3 in One Package of CPH6 Compared with Using Two Separate Packages

Typical Applications

- AM Tuner RF Amplification
- Low Noise Amplifier

SPECIFICATIONS ABSOLUTE MAXIMUM RATINGS $T_A = 25^\circ\text{C}$

Symbol	Parameter	Value	Unit
V_{DSX}	Drain to Source Voltage	25	V
V_{GDS}	Gate to Drain Voltage	-25	V
I_G	Gate Current	10	mA
I_D	Drain Current	50	mA
P_D	Allowable Power Dissipation 1 unit	400	mW
P_T	Total Power Dissipation	700	mW
T_J, T_{Stg}	Operating Junction and Storage Temperature	-55 to +150	$^\circ\text{C}$

Stresses exceeding those listed in the Maximum Ratings table may damage the device. If any of these limits are exceeded, device functionality should not be assumed, damage may occur and reliability may be affected.

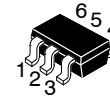

CPH6
CASE 318BD

ELECTRICAL CONNECTION N-Channel

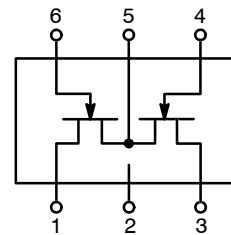

- 1 : Drain 1
- 2 : NC
- 3 : Drain 2
- 4 : Gate 2
- 5 : Source 1 / Source 2
- 6 : Gate 1

MARKING DIAGRAM

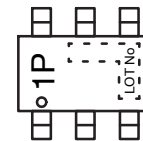

CPH6

ORDERING INFORMATION

See detailed ordering, marking and shipping information in the package dimensions section on page 4 of this data sheet.

NSVJ6904DSB6

ELECTRICAL CHARACTERISTICS $T_J = 25^\circ\text{C}$ (Note 1)

Symbol	Characteristic	Conditions	Min	Typ	Max	Unit
$V_{(BR)GDS}$	Gate to Drain Breakdown Voltage	$I_G = -10 \mu\text{A}$, $V_{DS} = 0 \text{ V}$	-25	-	-	V
I_{GSS}	Gate to Source Leakage Current	$V_{GS} = -10 \text{ V}$, $V_{DS} = 0 \text{ V}$	-	-	-1.0	nA
$V_{GS(off)}$	Cutoff Voltage	$V_{DS} = 5 \text{ V}$, $I_D = 100 \mu\text{A}$	-0.6	-1.2	-1.8	V
I_{DSS}	Zero-Gate Voltage Drain Current	$V_{DS} = 5 \text{ V}$, $V_{GS} = 0 \text{ V}$	20	-	40	mA
$ y_{fs} $	Forward Transfer Admittance	$V_{DS} = 5 \text{ V}$, $V_{GS} = 0 \text{ V}$, $f = 1 \text{ kHz}$	30	40	-	mS
C_{iss}	Input Capacitance	$V_{DS} = 5 \text{ V}$, $V_{GS} = 0 \text{ V}$, $f = 1 \text{ MHz}$	-	6.0	-	pF
C_{rss}	Reverse Transfer Capacitance		-	2.3	-	pF
NF	Noise Figure	$V_{DS} = 5 \text{ V}$, $V_{GS} = 0 \text{ V}$, $f = 100 \text{ MHz}$	-	2.1	2.8	dB

Product parametric performance is indicated in the Electrical Characteristics for the listed test conditions, unless otherwise noted. Product performance may not be indicated by the Electrical Characteristics if operated under different conditions.

1. The specifications shown above are for each individual JFET.

TYPICAL CHARACTERISTICS

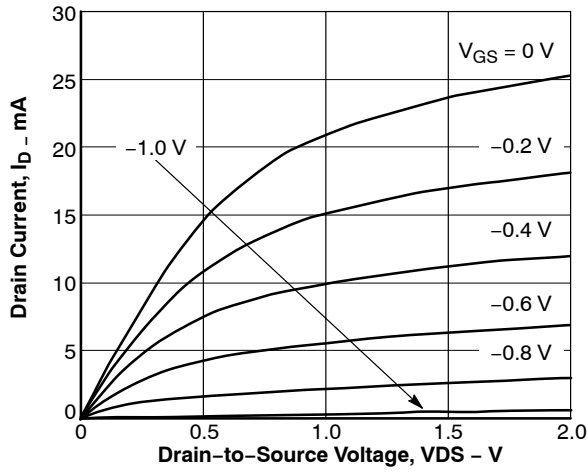

Figure 1. $I_D - V_{DS}$

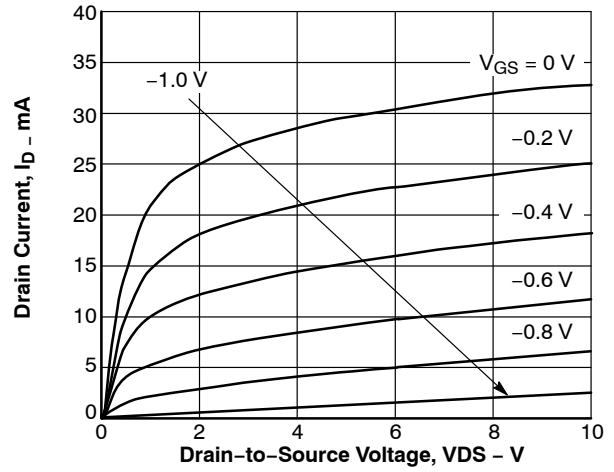

Figure 2. $I_D - V_{DS}$

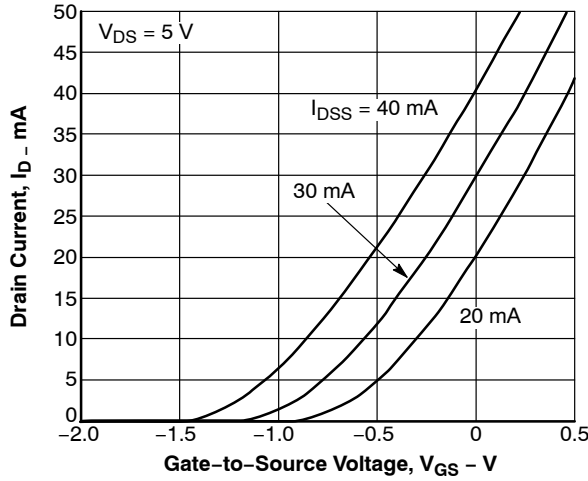

Figure 3. $I_D - V_{GS}$

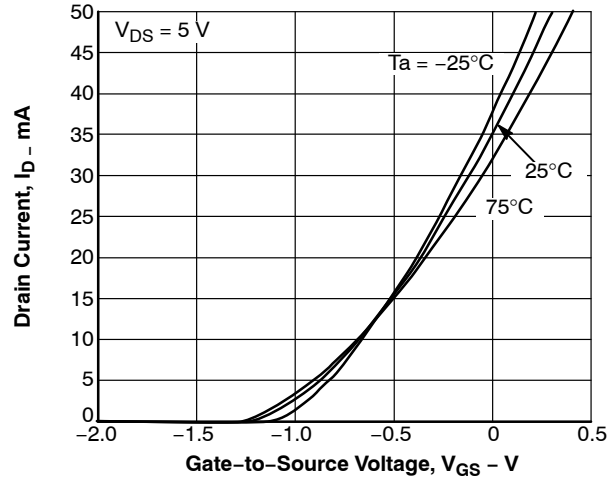

Figure 4. $I_D - V_{GS}$

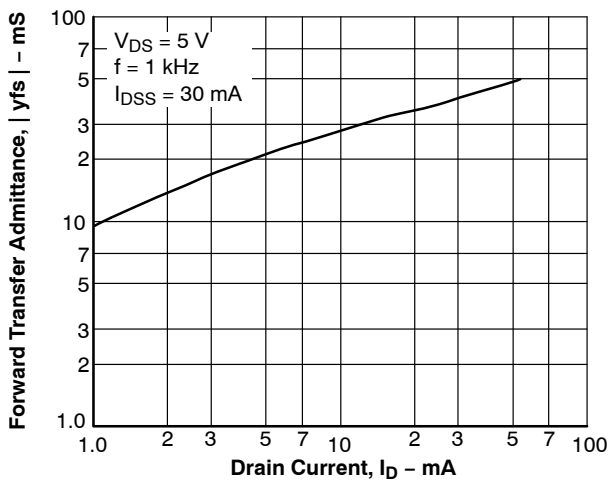

Figure 5. $|y_{fs}| - I_D$

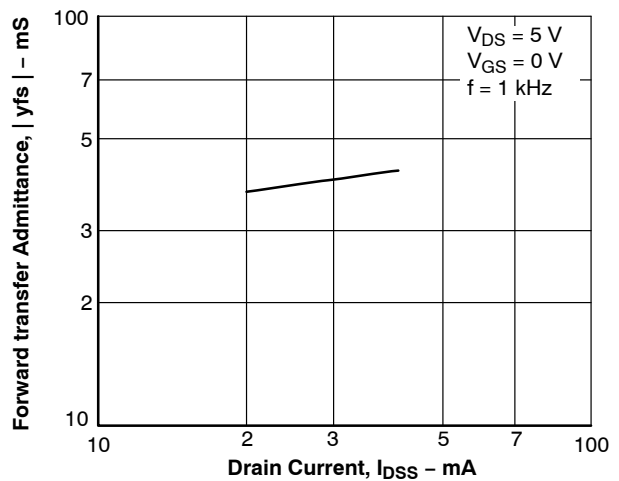

Figure 6. $|y_{fs}| - I_{DSS}$

NSVJ6904DSB6

TYPICAL CHARACTERISTICS (continued)

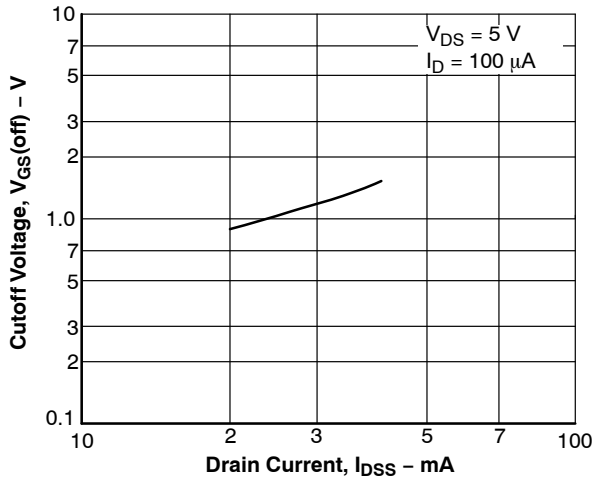

Figure 7. $V_{GS(off)}$ - I_{DSS}

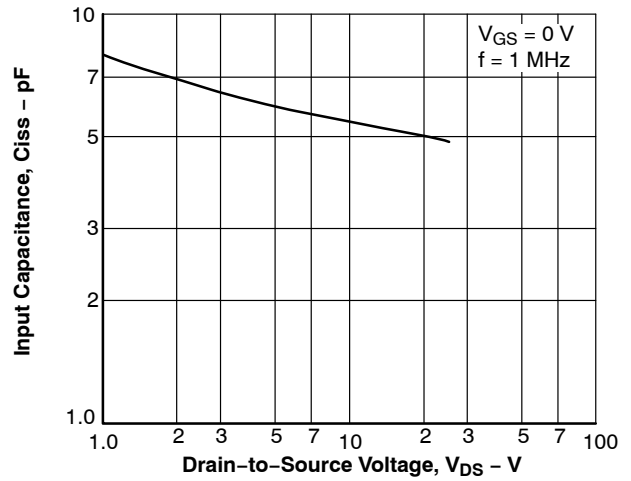

Figure 8. C_{iss} - V_{GDS}

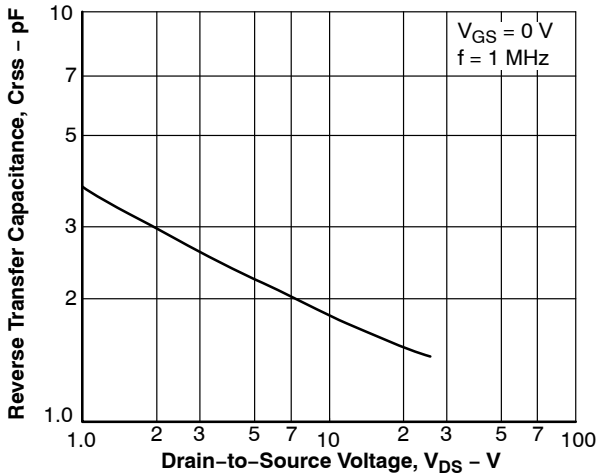

Figure 9. C_{rss} - V_{DS}

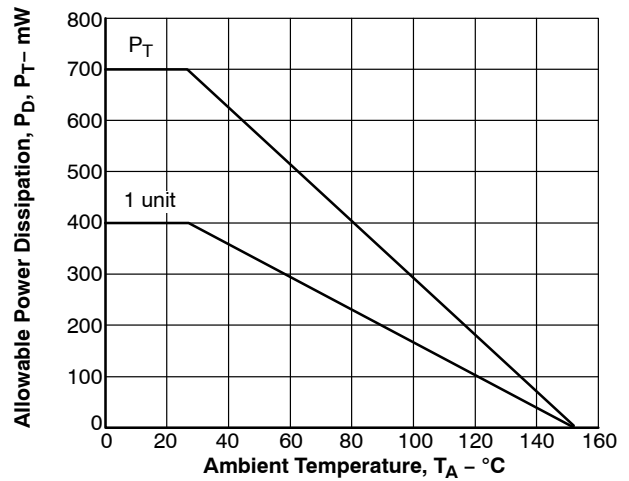
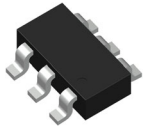

Figure 10. P_D , P_T - T_A

ORDERING INFORMATION

Device Order Number	Specific Device Marking	Package Type	Shipping [†]
NSVJ6904DSB6T1G	1P	CPH6 (Pb-Free / Halogen Free)	3,000 / Tape & Reel

[†]For information on tape and reel specifications, including part orientation and tape sizes, please refer to our Tape and Reel Packaging Specifications Brochure, [BRD8011/D](#).



CPH6 2.90x1.60x0.90, 0.95P
CASE 318BD
ISSUE A

DATE 20 SEPT 2024

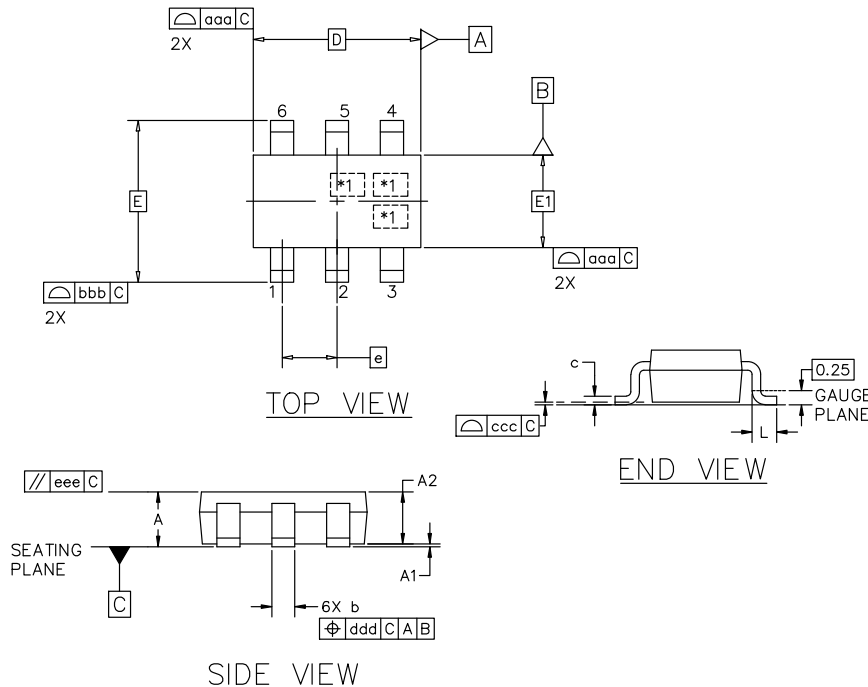

MILLIMETERS			
DIM	MIN	NOM	MAX
A	0.85	0.95	1.05
A1	0.00	0.05	0.10
A2	0.85	0.90	0.95
b	0.30	0.40	0.50
c	0.10	0.15	0.25
D	2.90 BSC		
E	2.80 BSC		
E1	1.60 BSC		
e	0.95 BSC		
L	0.10	0.20	0.30
TOLERANCE FORM AND POSITION			
aaa	0.10		
bbb	0.15		
ccc	0.05		
ddd	0.10		
eee	0.10		

NOTES:

1. DIMENSIONING AND TOLERANCING PER ASME Y14.5M, 2018.
2. CONTROLLING DIMENSION: MILLIMETERS
3. *1 IS FOR LOT INDICATION

GENERIC MARKING DIAGRAM*

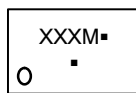

- XXX = Specific Device Code
- M = Date Code
- = Pb-Free Package

(Note: Microdot may be in either location)

*This information is generic. Please refer to device data sheet for actual part marking. Pb-Free indicator, "G" or microdot "▪", may or may not be present. Some products may not follow the Generic Marking.

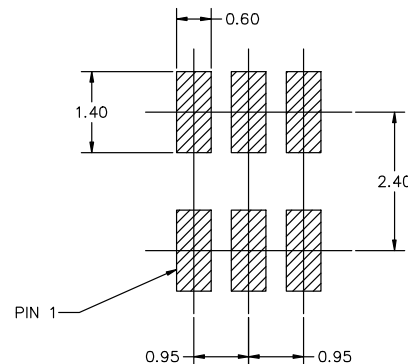

RECOMMENDED MOUNTING FOOTPRINT

* For additional information on our Pb-Free strategy and soldering details, please download the onsemi Soldering and Mounting Techniques Reference Manual, SOLDERRM/D.

DOCUMENT NUMBER:	98AON65440E	Electronic versions are uncontrolled except when accessed directly from the Document Repository. Printed versions are uncontrolled except when stamped "CONTROLLED COPY" in red.
DESCRIPTION:	CPH6 2.90x1.60x0.90, 0.95P	PAGE 1 OF 1

onsemi and ONSEMI are trademarks of Semiconductor Components Industries, LLC dba onsemi or its subsidiaries in the United States and/or other countries. onsemi reserves the right to make changes without further notice to any products herein. onsemi makes no warranty, representation or guarantee regarding the suitability of its products for any particular purpose, nor does onsemi assume any liability arising out of the application or use of any product or circuit, and specifically disclaims any and all liability, including without limitation special, consequential or incidental damages. onsemi does not convey any license under its patent rights nor the rights of others.

onsemi, **Onsemi**, and other names, marks, and brands are registered and/or common law trademarks of Semiconductor Components Industries, LLC dba "**onsemi**" or its affiliates and/or subsidiaries in the United States and/or other countries. **onsemi** owns the rights to a number of patents, trademarks, copyrights, trade secrets, and other intellectual property. A listing of **onsemi**'s product/patent coverage may be accessed at www.onsemi.com/site/pdf/Patent-Marking.pdf. **onsemi** reserves the right to make changes at any time to any products or information herein, without notice. The information herein is provided "as-is" and **onsemi** makes no warranty, representation or guarantee regarding the accuracy of the information, product features, availability, functionality, or suitability of its products for any particular purpose, nor does **onsemi** assume any liability arising out of the application or use of any product or circuit, and specifically disclaims any and all liability, including without limitation special, consequential or incidental damages. Buyer is responsible for its products and applications using **onsemi** products, including compliance with all laws, regulations and safety requirements or standards, regardless of any support or applications information provided by **onsemi**. "Typical" parameters which may be provided in **onsemi** data sheets and/or specifications can and do vary in different applications and actual performance may vary over time. All operating parameters, including "Typicals" must be validated for each customer application by customer's technical experts. **onsemi** does not convey any license under any of its intellectual property rights nor the rights of others. **onsemi** products are not designed, intended, or authorized for use as a critical component in life support systems or any FDA Class 3 medical devices or medical devices with a same or similar classification in a foreign jurisdiction or any devices intended for implantation in the human body. Should Buyer purchase or use **onsemi** products for any such unintended or unauthorized application, Buyer shall indemnify and hold **onsemi** and its officers, employees, subsidiaries, affiliates, and distributors harmless against all claims, costs, damages, and expenses, and reasonable attorney fees arising out of, directly or indirectly, any claim of personal injury or death associated with such unintended or unauthorized use, even if such claim alleges that **onsemi** was negligent regarding the design or manufacture of the part. **onsemi** is an Equal Opportunity/Affirmative Action Employer. This literature is subject to all applicable copyright laws and is not for resale in any manner.

ADDITIONAL INFORMATION

TECHNICAL PUBLICATIONS:

Technical Library: www.onsemi.com/design/resources/technical-documentation
onsemi Website: www.onsemi.com

ONLINE SUPPORT: www.onsemi.com/support

For additional information, please contact your local Sales Representative at www.onsemi.com/support/sales