

NCP5504, NCV5504

Linear Regulator - Dual Output, Low Dropout

250 mA

The NCP5504/NCV5504 are dual output low dropout linear regulators with $\pm 2.0\%$ accuracy over the operating temperature range. They feature a fixed output voltage of 3.3 V (contact factory for other fixed output voltage options) and an adjustable output that ranges from 1.25 V to 5.0 V. It is available in a 5 pin DPAK Pb-Free package.

The NCP5504/NCV5504 employs an architecture that offers low noise without a bypass capacitor for the fixed output. This device along with a ripple rejection of 75 dB and a dropout of 250 mV @ 250 mA, suits post-regulation and power sensitive battery-operated applications.

Features

- One Fixed and One Adjustable Output Pin
- 250 mA Each Output
- Adjustable Output Voltage from 1.25 V to 5.0 V
- Low Dropout Voltage of 250 mV typical at 250 mA
- Low Quiescent Current of 370 μ A typical
- Ripple Rejection of 75 dB
- Temperature Range of NCP5504 -25°C to $+85^{\circ}\text{C}$
Temperature Range of NCV5504 -40°C to $+125^{\circ}\text{C}$
- Low Noise Without Bypass Capacitor; 90 μ Vrms
- Line Regulation < 15 mV
- Load Regulation; $V_{\text{out}1} < 15$ mV, $V_{\text{out}2} < 10$ mV
- Accuracy of $\pm 2\%$ Overtemperature Range
- Thermal Protection and Current Limit
- Short Circuit Protection
- NCV Prefix for Automotive and Other Applications Requiring Unique Site and Control Change Requirements; AEC-Q100 Qualified and PPAP Capable
- These are Pb-Free Devices

Typical Applications

- Audio Visual Equipment
- Battery Powered Consumer Products
- Instrumentation
- Computing and Networking Applications
- Automotive Electronics



ON Semiconductor®

<http://onsemi.com>

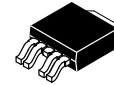

DPAK-5
DT SUFFIX
CASE 175AA

MARKING DIAGRAM

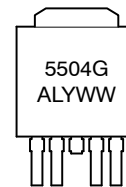

Pin 1. Adjust for V_{out}
2. $V_{\text{out}2}$
3. GND
4. V_{in}
5. $V_{\text{out}1}$

A = Assembly Location
L = Wafer Lot
Y = Year
WW = Work Week
G = Pb-Free Package

ORDERING INFORMATION

See detailed ordering and shipping information in the package dimensions section on page 9 of this data sheet.

NCP5504, NCV5504

PIN FUNCTION DESCRIPTION

Pin No.	Pin Name	Description
1	Adjust for V_{out2}	This pin is connected to the resistor divider on the output. For a 1.25 V output, connect directly to the V_{out2} pin.
2	V_{out2}	Adjustable Regulated Output Voltage.
3	GND	Power Supply Ground
4	V_{in}	Positive Power Supply Input Voltage.
5	V_{out1}	Fixed Regulated Output Voltage. See selector guide for options.

MAXIMUM RATINGS

Rating	Symbol	Value	Unit
Input Voltage	V_{in}	18	V
Operating Input Voltage for Power Considerations	V_{in}	9.0	V
Output Pin Voltage	V_{out}	-0.3 to $V_{in} + 0.3$	V
Adjust Pin Voltage	V_{adj}	-0.3 to $V_{in} + 0.3$	V
Maximum Junction Temperature NCP5504 NCV5504	T_J	125 150	°C
Operating Ambient Temperature NCP5504 NCV5504	T_A	-25°C to +85°C -40°C to +125°C	°C
Package Thermal Resistance Thermal Resistance, Junction-to-Air Thermal Resistance, Junction-to-Case	$R_{\theta JA}$ $R_{\theta JC}$	100 8	°C/W
Storage Temperature Range	T_{stg}	-55 to +150	°C
Electrostatic Discharge Sensitivity Human Body Model (HBM) Machine Model (MM) Charge Device Model (CDM)	ESD	2000 200 2000	V
Latchup Performance (JEDEC78) Positive Negative	$I_{Latchup}$	100 100	mA

Stresses exceeding Maximum Ratings may damage the device. Maximum Ratings are stress ratings only. Functional operation above the Recommended Operating Conditions is not implied. Extended exposure to stresses above the Recommended Operating Conditions may affect device reliability.

NCP5504, NCV5504

NCP5504 ELECTRICAL CHARACTERISTICS

($V_{in} = V_{out} + 1.0$ V, where V_{out} is the larger of V_{out1} or V_{out2} , $T_A = 25^\circ\text{C}$, unless otherwise noted)

Characteristic	Symbol	Min	Typ	Max	Unit
Output Voltage NCP5504 ($T_A = -25^\circ\text{C}$ to 85°C), $I_O = 250$ mA	V_{out} V_{out1} V_{out2}	-2% -2%	3.30 1.25	+2% +2%	V
Adjustable Pin Current	I_{adj}	-	50	100	nA
Line Regulation ($V_{out} + 1.0$ V < V_{in} < 7.0 V), $I_O = 250$ mA	Reg_{line}	-	5	15	mV
Load Regulation (1.0 mA < I_O < 250 mA) for V_{out1} Load Regulation (1.0 mA < I_O < 250 mA) for V_{out2}	Reg_{load}	-	10 5	15 10	mV mV
Dropout Voltage ($I_O = 250$ mA)	V_{DO}	-	250	400	mV
Ripple Rejection Ratio ($I_O = 250$ mA)	RR	-	75 60	-	dB
			120 Hz 1 kHz		
Quiescent Current ($I_{O1}, I_{O2} = 0$ mA)	I_q	-	370	450	μA
Fixed Output Noise Voltage (10 Hz – 100 kHz $V_{out} = 3.3$ V, $I_O = 100$ mA, $C_O = 1.0$ μF)	V_n	-	90	-	μV_{rms}
Ground Current ($I_{O1}, I_{O2} = 250$ mA)	I_{gnd}	-	10	20	mA
Thermal Shutdown (Guaranteed by design)	T_{Jmax}	150	165	-	$^\circ\text{C}$
Current Limit on V_{out1} and V_{out2}	I_{lim}	350	450	-	mA

NCV5504 ELECTRICAL CHARACTERISTICS

($V_{in} = V_{out} + 1.0$ V, where V_{out} is the larger of V_{out1} or V_{out2} , $-40^\circ\text{C} \leq T_J \leq 150^\circ\text{C}$, $-40^\circ\text{C} \leq T_A \leq 125^\circ\text{C}$, unless otherwise noted)

Characteristic	Symbol	Min	Typ	Max	Unit
Output Voltage NCV5504, $I_O = 250$ mA	V_{out} V_{out1} V_{out2}	-2% -2%	3.30 1.25	+2% +2%	V
Adjustable Pin Current	I_{adj}	-	50	100	nA
Line Regulation ($V_{out} + 1.0$ V < V_{in} < 7.0 V), $I_O = 250$ mA	Reg_{line}	-	5	15	mV
Load Regulation (1.0 mA < I_O < 250 mA) for V_{out1} Load Regulation (1.0 mA < I_O < 250 mA) for V_{out2}	Reg_{load}	-	10 5	15 10	mV mV
Dropout Voltage ($I_O = 250$ mA)	V_{DO}	-	250	400	mV
Ripple Rejection Ratio ($I_O = 250$ mA)	RR	-	75 60	-	dB
			120 Hz 1 kHz		
Quiescent Current ($I_{O1}, I_{O2} = 0$ mA)	I_q	-	370	450	μA
Fixed Output Noise Voltage (10 Hz – 100 kHz $V_{out} = 3.3$ V, $I_O = 100$ mA, $C_O = 1.0$ μF)	V_n	-	90	-	μV_{rms}
Ground Current ($I_{O1}, I_{O2} = 250$ mA)	I_{gnd}	-	10	20	mA
Thermal Shutdown (Guaranteed by design)	T_{Jmax}	150	165	-	$^\circ\text{C}$
Current Limit on V_{out1} and V_{out2}	I_{lim}	320	450	-	mA

NCP5504, NCV5504

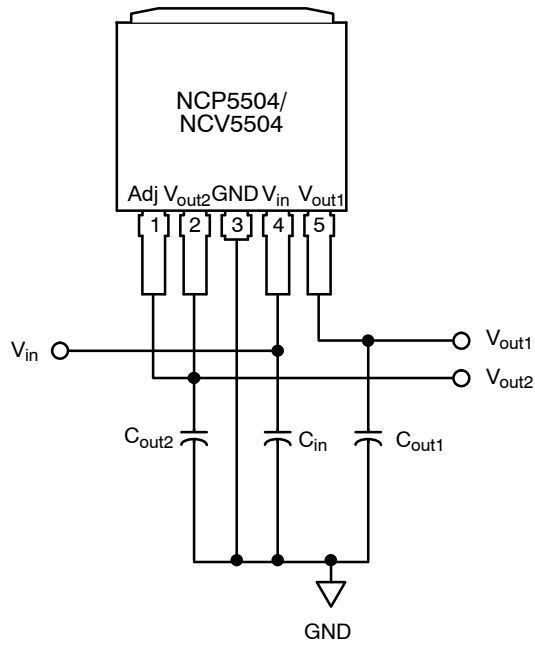

Figure 1. Application Schematic, Fixed Output Version. $V_{out1} = 3.3\text{ V}$, $V_{out2} = 1.25\text{ V}$

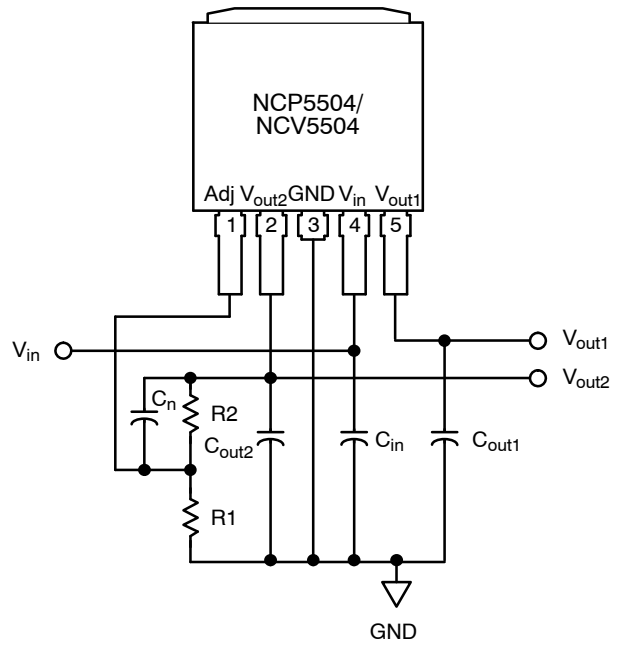

Figure 2. Application Schematic, Adjustable Version. $V_{out1} = 3.3\text{ V}$, $V_{out2} = 1.25\text{ V to } 5.0\text{ V}$, Where $V_{out2} = 1.25\text{ V} * (1 + R2/R1)$

NOTE: Please note that in order to maintain high accuracy on the adjustable output (V_{out2}), use R1 values $< 30\text{ k}\Omega$ in the resistor divider. The recommended capacitor type and values are as follows:

C_{in} (Tantalum or Aluminum Electrolytic) = $4.7\text{ }\mu\text{F to } 100\text{ }\mu\text{F}$

C_{out1} , C_{out2} = Low ESR, $1.0\text{ }\mu\text{F to } 22\text{ }\mu\text{F}$

C_n = $200\text{ pF to } 1.0\text{ nF}$.

NCP5504, NCV5504

TYPICAL CHARACTERISTICS

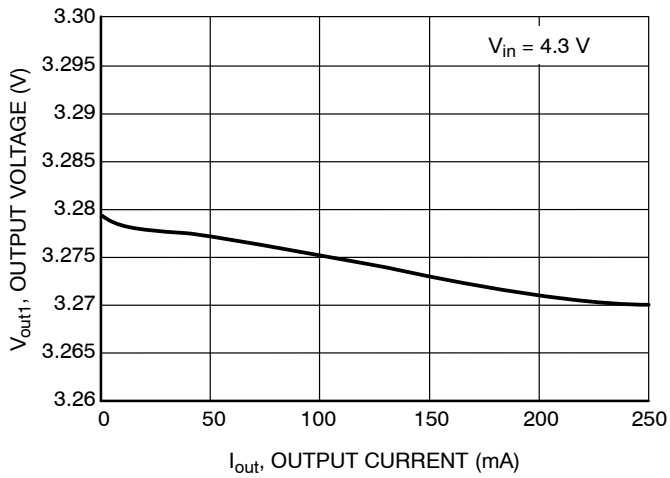

Figure 3. Output Voltage vs. Output Load Current for V_{out1}

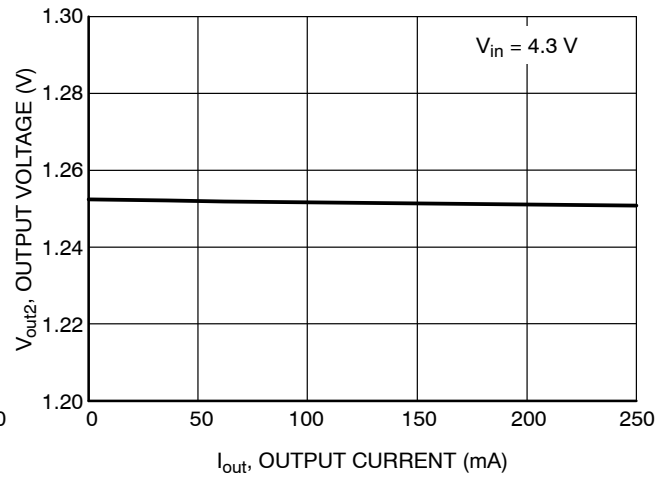

Figure 4. Output Voltage vs. Output Load Current for V_{out2}

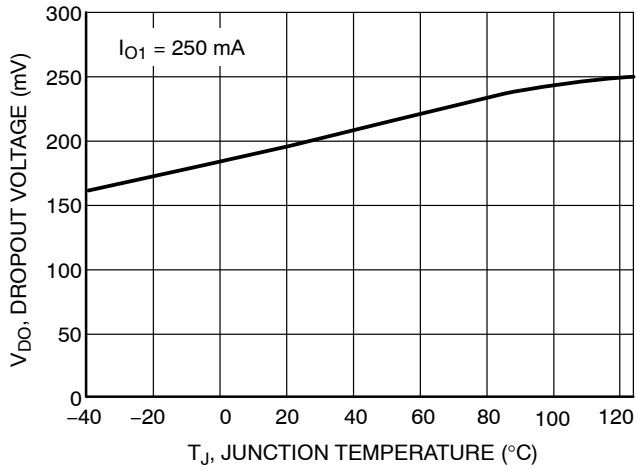

Figure 5. Dropout Voltage vs. Temperature for V_{out1}

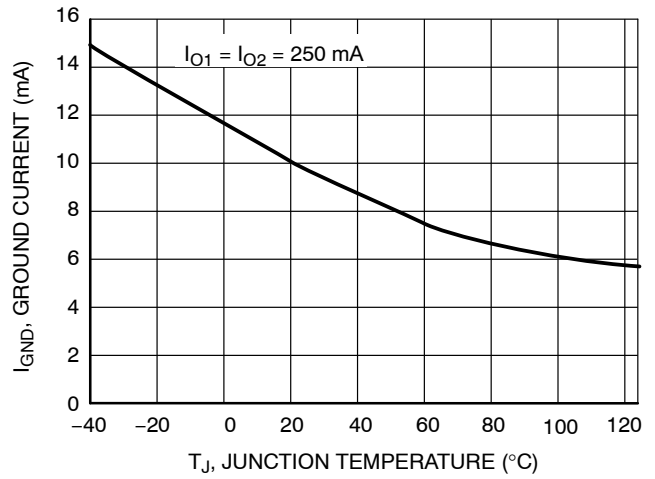

Figure 6. Ground Current vs. Temperature

NCP5504, NCV5504

TYPICAL CHARACTERISTICS

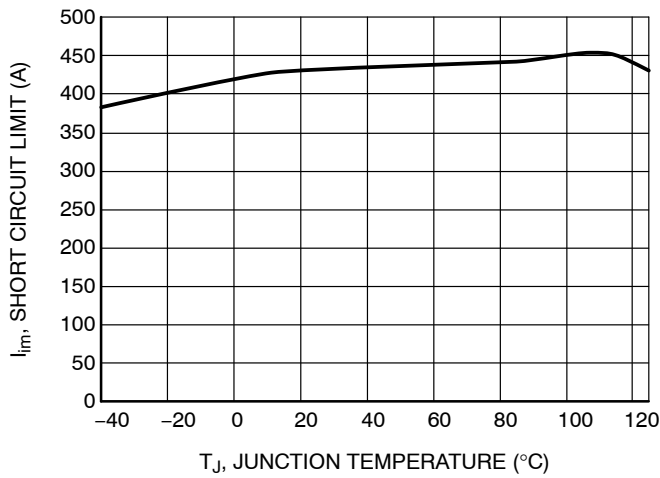

Figure 7. Short Circuit Current Limit vs. Temperature for V_{out1}

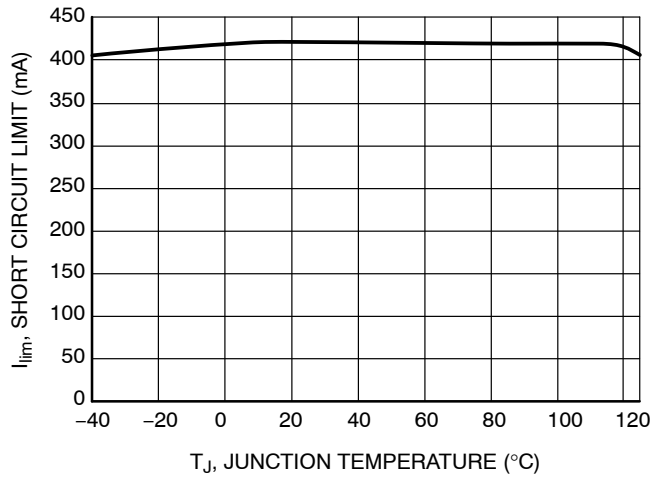

Figure 8. Short Circuit Current Limit vs. Temperature for V_{out2}

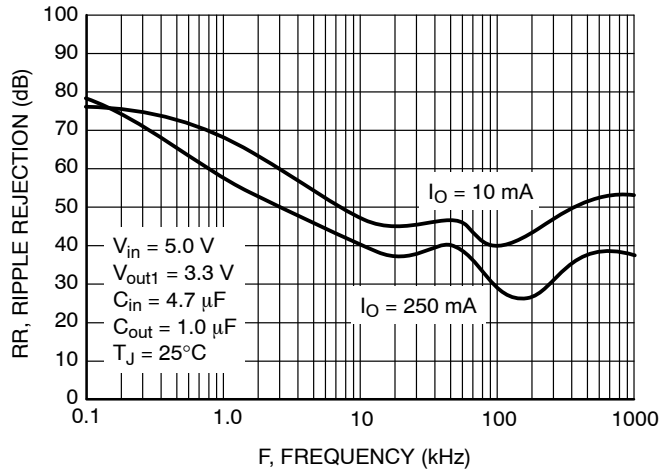

Figure 9. Ripple Rejection vs. Frequency for V_{out1}

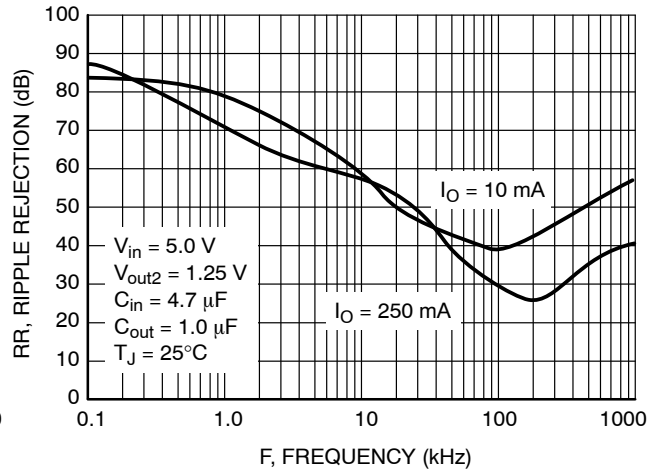

Figure 10. Ripple Rejection vs. Frequency for V_{out2}

TYPICAL CHARACTERISTICS

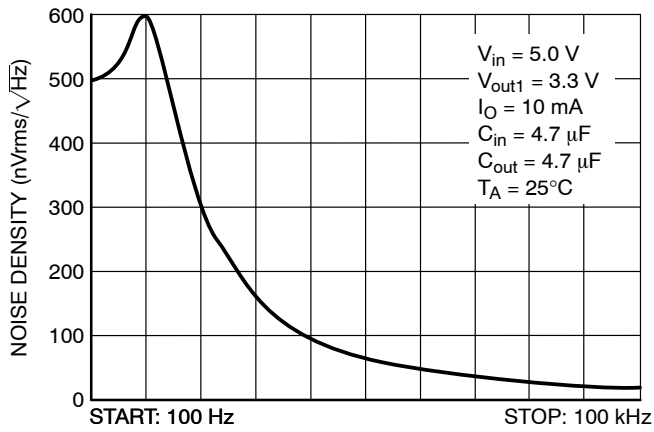

Figure 11. Noise Density vs. Frequency

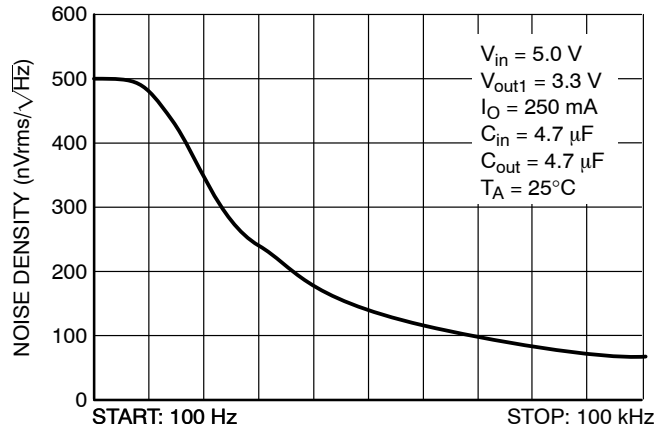

Figure 12. Noise Density vs. Frequency

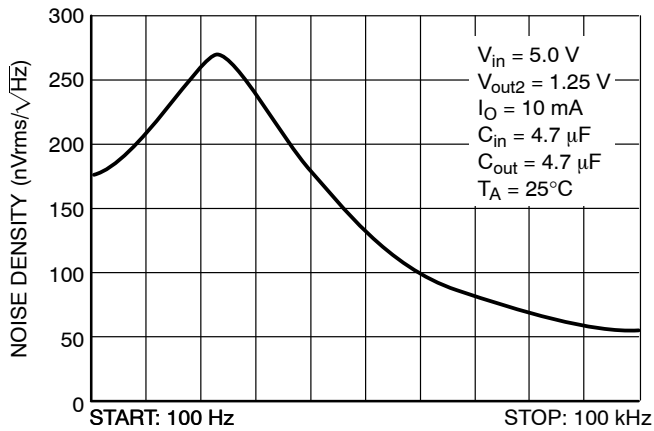

Figure 13. Noise Density vs. Frequency

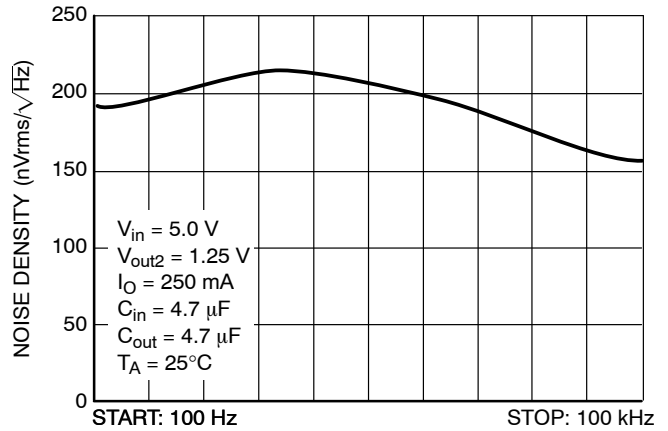
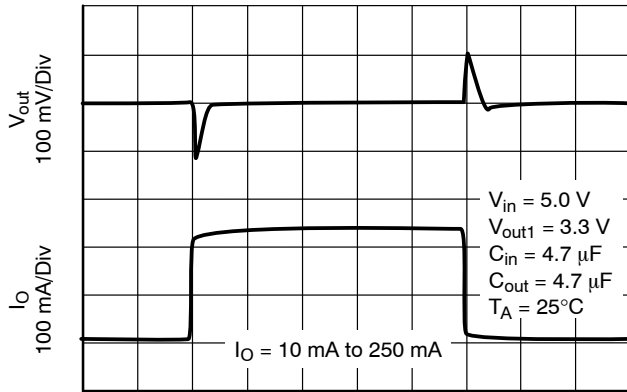

Figure 14. Noise Density vs. Frequency

TYPICAL CHARACTERISTICS



TIME (100 μS/Div)

Figure 15. Load Transient Response for V_{out1}

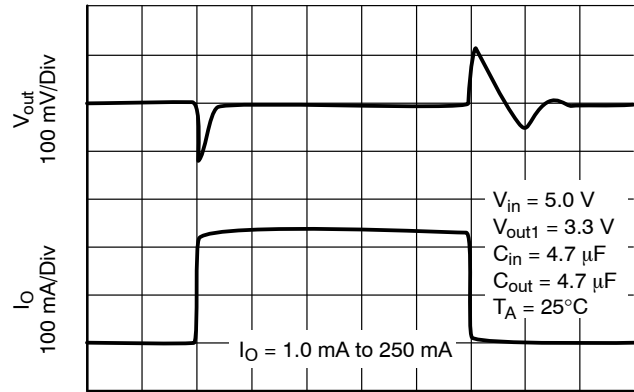

TIME (100 μS/Div)

Figure 16. Load Transient Response for V_{out1}

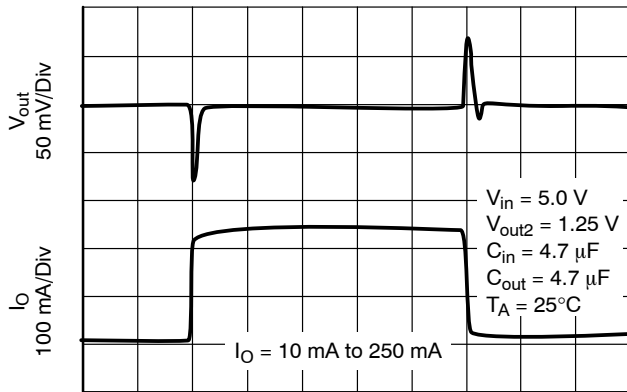

TIME (100 μS/Div)

Figure 17. Load Transient Response for V_{out2}

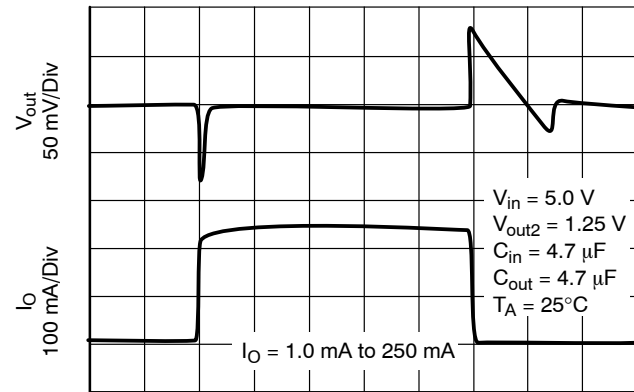

TIME (100 μS/Div)

Figure 18. Load Transient Response for V_{out2}

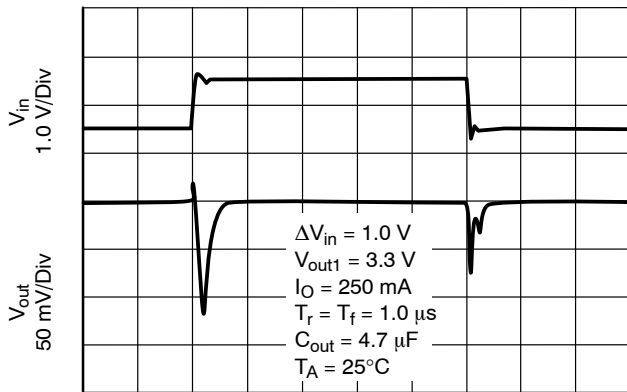

TIME (40 μS/Div)

Figure 19. Line Transient Response for V_{out1}

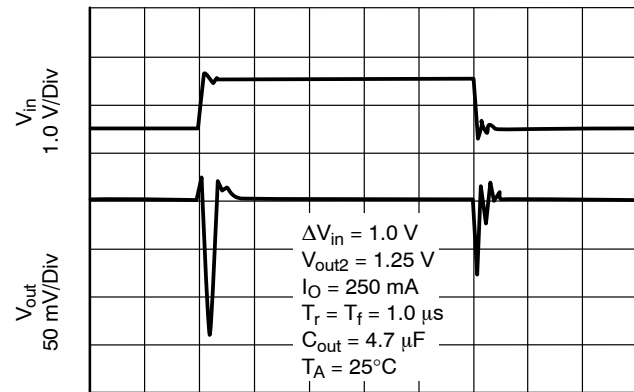

TIME (40 μS/Div)

Figure 20. Line Transient Response for V_{out2}

NCP5504, NCV5504

APPLICATION INFORMATION

Introduction

The NCP5504/NCV5504 are high performance dual output, 250 mA linear regulators suitable for post regulation and power sensitive battery-operated applications. They feature $\pm 2.0\%$ accuracy over the operating temperature range. With one fixed output voltage at 3.3 V, and one adjustable output voltage ranging from 1.25 V to 5.0 V, the dropout voltage is 250 mV typical. Additional features, such as an architecture that allows for low noise on the fixed output without a bypass capacitor, provides for an attractive LDO solution for audio visual equipment, instrumentation, computing and networking applications, and automotive electronics. It is thermally robust and is offered in a 5 pin DPAK Pb-Free package.

Capacitor Selection

The recommended input capacitor types are tantalum and aluminum electrolytic ranging from 4.7 μF to 100 μF . It is especially required if the power source is located more than a few inches from the NCP5504/NCV5504. This capacitor

will reduce device sensitivity and enhance the output transient response time. The PCB layout is very important and in order to obtain the optimal solution, the V_{in} and GND traces should be sufficiently wide to minimize noise and unstable operation.

For the adjustable output pin, C_n ranges from 200 pF and 1.0 nF.

The output capacitor range is between 1.0 μF and 22 μF . For PCB layout considerations, place the capacitor close to the output pin and keep the leads short.

Adjustable Output Operation

The application circuit for the adjustable output version is shown in Figure 2. V_{out2} is calculated based on the following equation:

$$V_{out2} = 1.25 \text{ V} * \left(1 + \frac{R2}{R1} \right)$$

In order to maintain high accuracy on the adjustable output, $R1$ values should be $< 30 \text{ k}\Omega$.

ORDERING INFORMATION

Device	Package	Shipping [†]
NCP5504DTRKG	DPAK (Pb-Free)	2500 / Tape and Reel
NCV5504DTRKG*	DPAK (Pb-Free)	2500 / Tape and Reel

[†]For information on tape and reel specifications, including part orientation and tape sizes, please refer to our Tape and Reel Packaging Specifications Brochure, BRD8011/D.

*NCV Prefix for Automotive and Other Applications Requiring Unique Site and Control Change Requirements; AEC-Q100 Qualified and PPAP Capable

MECHANICAL CASE OUTLINE

PACKAGE DIMENSIONS

ON Semiconductor®

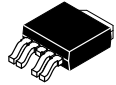

DPAK-5, CENTER LEAD CROP

CASE 175AA

ISSUE B

DATE 15 MAY 2014

SCALE 1:1

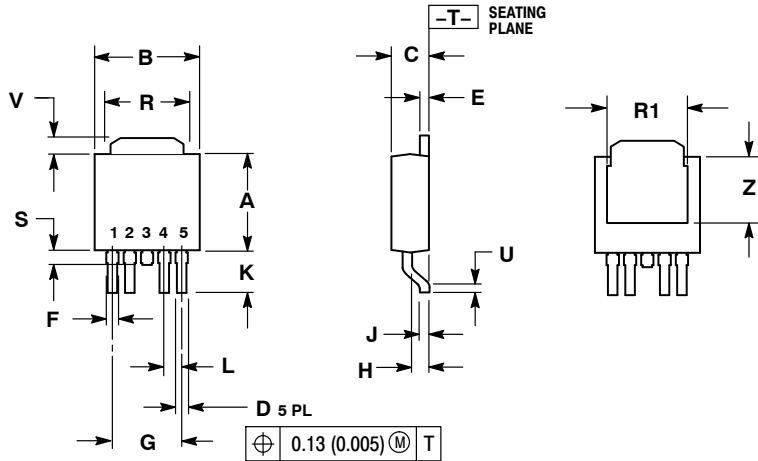

- NOTES:
1. DIMENSIONING AND TOLERANCING PER ANSI Y14.5M, 1982.
 2. CONTROLLING DIMENSION: INCH.

DIM	INCHES		MILLIMETERS	
	MIN	MAX	MIN	MAX
A	0.235	0.245	5.97	6.22
B	0.250	0.265	6.35	6.73
C	0.086	0.094	2.19	2.38
D	0.020	0.028	0.51	0.71
E	0.018	0.023	0.46	0.58
F	0.024	0.032	0.61	0.81
G	0.180 BSC		4.56 BSC	
H	0.034	0.040	0.87	1.01
J	0.018	0.023	0.46	0.58
K	0.102	0.114	2.60	2.89
L	0.045 BSC		1.14 BSC	
R	0.170	0.190	4.32	4.83
R1	0.185	0.210	4.70	5.33
S	0.025	0.040	0.63	1.01
U	0.020	---	0.51	---
V	0.035	0.050	0.89	1.27
Z	0.155	0.170	3.93	4.32

RECOMMENDED SOLDERING FOOTPRINT*

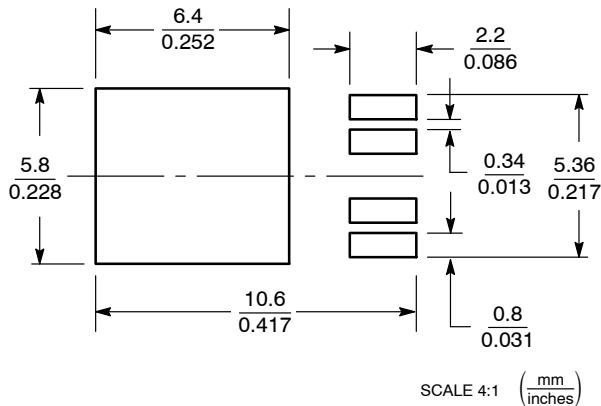

*For additional information on our Pb-Free strategy and soldering details, please download the ON Semiconductor Soldering and Mounting Techniques Reference Manual, SOLDERRM/D.

GENERIC MARKING DIAGRAMS*

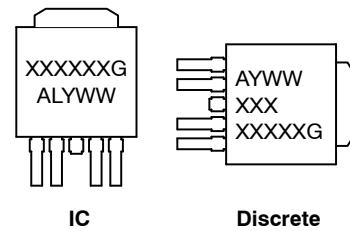

- XXXXXX = Device Code
- A = Assembly Location
- L = Wafer Lot
- Y = Year
- WW = Work Week
- G = Pb-Free Package

*This information is generic. Please refer to device data sheet for actual part marking. Pb-Free indicator, "G" or microdot "▪", may or may not be present.

DOCUMENT NUMBER:	98AON12855D	Electronic versions are uncontrolled except when accessed directly from the Document Repository. Printed versions are uncontrolled except when stamped "CONTROLLED COPY" in red.
DESCRIPTION:	DPAK-5 CENTER LEAD CROP	PAGE 1 OF 1

ON Semiconductor and are trademarks of Semiconductor Components Industries, LLC dba ON Semiconductor or its subsidiaries in the United States and/or other countries. ON Semiconductor reserves the right to make changes without further notice to any products herein. ON Semiconductor makes no warranty, representation or guarantee regarding the suitability of its products for any particular purpose, nor does ON Semiconductor assume any liability arising out of the application or use of any product or circuit, and specifically disclaims any and all liability, including without limitation special, consequential or incidental damages. ON Semiconductor does not convey any license under its patent rights nor the rights of others.

onsemi, **Onsemi**, and other names, marks, and brands are registered and/or common law trademarks of Semiconductor Components Industries, LLC dba "**onsemi**" or its affiliates and/or subsidiaries in the United States and/or other countries. **onsemi** owns the rights to a number of patents, trademarks, copyrights, trade secrets, and other intellectual property. A listing of **onsemi**'s product/patent coverage may be accessed at www.onsemi.com/site/pdf/Patent-Marking.pdf. **onsemi** reserves the right to make changes at any time to any products or information herein, without notice. The information herein is provided "as-is" and **onsemi** makes no warranty, representation or guarantee regarding the accuracy of the information, product features, availability, functionality, or suitability of its products for any particular purpose, nor does **onsemi** assume any liability arising out of the application or use of any product or circuit, and specifically disclaims any and all liability, including without limitation special, consequential or incidental damages. Buyer is responsible for its products and applications using **onsemi** products, including compliance with all laws, regulations and safety requirements or standards, regardless of any support or applications information provided by **onsemi**. "Typical" parameters which may be provided in **onsemi** data sheets and/or specifications can and do vary in different applications and actual performance may vary over time. All operating parameters, including "Typicals" must be validated for each customer application by customer's technical experts. **onsemi** does not convey any license under any of its intellectual property rights nor the rights of others. **onsemi** products are not designed, intended, or authorized for use as a critical component in life support systems or any FDA Class 3 medical devices or medical devices with a same or similar classification in a foreign jurisdiction or any devices intended for implantation in the human body. Should Buyer purchase or use **onsemi** products for any such unintended or unauthorized application, Buyer shall indemnify and hold **onsemi** and its officers, employees, subsidiaries, affiliates, and distributors harmless against all claims, costs, damages, and expenses, and reasonable attorney fees arising out of, directly or indirectly, any claim of personal injury or death associated with such unintended or unauthorized use, even if such claim alleges that **onsemi** was negligent regarding the design or manufacture of the part. **onsemi** is an Equal Opportunity/Affirmative Action Employer. This literature is subject to all applicable copyright laws and is not for resale in any manner.

ADDITIONAL INFORMATION

TECHNICAL PUBLICATIONS:

Technical Library: www.onsemi.com/design/resources/technical-documentation
onsemi Website: www.onsemi.com

ONLINE SUPPORT: www.onsemi.com/support

For additional information, please contact your local Sales Representative at www.onsemi.com/support/sales