

IGBT - NPT

600 V

HGTG30N60B3

Description

The HGTG30N60B3 combines the best features of high input impedance of a MOSFET and the low on-state conduction loss of a bipolar transistor. The IGBT is ideal for many high voltage switching applications operating at moderate frequencies where low conduction losses are essential, such as: UPS, solar inverter and power supplies.

Features

- 30 A, 600 V, $T_C = 110^\circ\text{C}$
- Low Saturation Voltage: $V_{CE(SAT)} = 1.45\text{ V @ } I_C = 30\text{ A}$
- Typical Fall Time 90 ns at $T_J = 150^\circ\text{C}$
- Short Circuit Rating
- Low Conduction Loss
- This Device is Pb-Free



ON Semiconductor®

www.onsemi.com

V_{CES}	I_C
1200 V	30 A

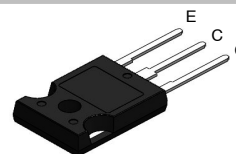
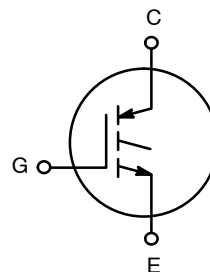

TO-247-3LD
CASE 340CK

MARKING DIAGRAM

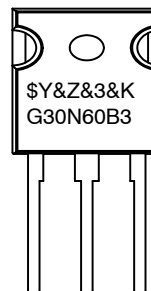

- | | |
|----------|-------------------------|
| \$Y | = ON Semiconductor Logo |
| &Z | = Assembly Plant Code |
| &3 | = Numeric Date Code |
| &K | = Lot Code |
| G30N60B3 | = Specific Device Code |

ORDERING INFORMATION

See detailed ordering and shipping information on page 2 of this data sheet.

HGTG30N60B3

ABSOLUTE MAXIMUM RATINGS (T_C = 25°C unless otherwise noted)

Symbol	Description	Ratings	Unit
BV _{CES}	Collector to Emitter Voltage	600	V
I _C	Collector Current Continuous	T _C = 25°C	60
		T _C = 110°C	30
I _{CM}	Collector Current Pulsed (Note 1)	220	A
V _{GES}	Gate to Emitter Voltage Continuous	±20	V
V _{GEM}	Gate to Emitter Voltage Pulsed	±30	V
SSOA	Switching Safe Operating Area at T _J = 150°C (Figure 2)	60 A at 600 V	
P _D	Power Dissipation Total	T _C = 25°C	208
	Power Dissipation Derating	T _C > 25°C	1.67
E _{ARV}	Reverse Voltage Avalanche Energy	100	mJ
T _J , T _{STG}	Operating and Storage Junction Temperature Range	-55 to +150	°C
T _L	Maximum Lead Temperature for Soldering	260	°C
T _{SC}	Short Circuit Withstand Time (Note 2)	V _{GE} = 12 V	4
	Short Circuit Withstand Time (Note 2)	V _{GE} = 10 V	10

Stresses exceeding those listed in the Maximum Ratings table may damage the device. If any of these limits are exceeded, device functionality should not be assumed, damage may occur and reliability may be affected.

1. Pulse width limited by maximum junction temperature.
2. V_{CE(PK)} = 360 V, T_J = 125°C, R_G = 3 Ω

PACKAGE MARKING AND ORDERING INFORMATION

Part Number	Top Mark	Package	Packing Method	Shipping
HGTG30N60B3	G30N60B3	TO-247	Tube	450/Tube

ELECTRICAL CHARACTERISTICS OF THE IGBT (T_C = 25°C unless otherwise noted)

Symbol	Parameter	Test Conditions	Min.	Typ.	Max.	Unit
BV _{CES}	Collector to Emitter Breakdown Voltage	I _C = 250 μA, V _{GE} = 0 V	600	-	-	V
BV _{ECS}	Emitter to Collector Breakdown Voltage	I _C = -10 mA, V _{GE} = 0 V	20	-	-	V
I _{CES}	Collector to Emitter Leakage Current	V _{CE} = BV _{CES} , T _C = 25°C	-	-	250	μA
		V _{GE} = BV _{CES} , T _C = 150°C	-	-	3.0	mA
V _{CE(SAT)}	Collector to Emitter Saturation Voltage	I _C = I _{C110} , V _{GE} = 15 V, T _C = 25°C	-	1.45	1.9	V
		I _C = I _{C110} , V _{GE} = 15 V, T _C = 150°C	-	1.7	2.1	V
V _{GE(th)}	Gate to Emitter Threshold Voltage	I _C = 250 μA, V _{CE} = V _{GE}	4.2	5.0	6.0	V
I _{GES}	Gate to Emitter Leakage Current	V _{GE} = ±20 V	-	-	±250	nA
SSOA	Switching SOA	T _J = 150°C, R _G = 3 Ω, V _{GE} = 15 V, L = 100 μH, V _{CE(PK)} = 480 V	200		-	A
		T _J = 150°C, R _G = 3 Ω, V _{GE} = 15 V, L = 100 μH, V _{CE(PK)} = 600 V	60		-	A
V _{GEP}	Gate to Emitter Plateau Voltage	I _C = I _{C110} , V _{CE} = 0.5 BV _{CES}	-	7.2	-	V
Q _{G(ON)}	On-State Gate Charge	I _C = I _{C110} , V _{CE} = 0.5 BV _{CES} , V _{GE} = 15 V	-	170	190	nC
		I _C = I _{C110} , V _{CE} = 0.5 BV _{CES} , V _{GE} = 20 V	-	230	250	nC

HGTG30N60B3

ELECTRICAL CHARACTERISTICS OF THE IGBT ($T_C = 25^\circ\text{C}$ unless otherwise noted) (continued)

Symbol	Parameter	Test Conditions	Min.	Typ.	Max.	Unit
$T_{d(on)l}$	Current Turn-On Delay Time	IGBT and Diode at $T_J = 25^\circ\text{C}$ $I_{CE} = I_{C110}$ $V_{CE} = 0.8 BV_{CES}$ $V_{GE} = 15\text{ V}$ $R_G = 3\ \Omega$ $L = 1\text{ mH}$ Test Circuit (Figure 17)	–	36	–	ns
T_{rl}	Current Rise Time		–	25	–	ns
$T_{d(off)l}$	Current Turn-Off Delay Time		–	137	–	ns
T_{fl}	Current Fall Time		–	58	–	ns
E_{on1}	Turn-On Energy (Note 4)		–	500	–	μJ
E_{on2}	Turn-On Energy (Note 4)		–	550	800	μJ
E_{off}	Turn-Off Energy (Note 3)		–	680	900	μJ
$T_{d(on)l}$	Current Turn-On Delay Time	IGBT and Diode at $T_J = 150^\circ\text{C}$ $I_{CE} = I_{C110}$ $V_{CE} = 0.8 BV_{CES}$ $V_{GE} = 15\text{ V}$ $R_G = 3\ \Omega$ $L = 1\text{ mH}$ Test Circuit (Figure 17)	–	32	–	ns
T_{rl}	Current Rise Time		–	24	–	ns
$T_{d(off)l}$	Current Turn-Off Delay Time		–	275	320	ns
T_{fl}	Current Fall Time		–	90	150	ns
E_{on1}	Turn-On Energy (Note 4)		–	500	–	μJ
E_{on2}	Turn-On Energy (Note 4)		–	1300	1550	μJ
E_{off}	Turn-Off Energy (Note 3)		–	1600	1900	μJ
$R_{\theta JC}$	Thermal Resistance Junction To Case		–	–	0.6	$^\circ\text{C}/\text{W}$

Product parametric performance is indicated in the Electrical Characteristics for the listed test conditions, unless otherwise noted. Product performance may not be indicated by the Electrical Characteristics if operated under different conditions.

- Turn-Off Energy Loss (E_{OFF}) is defined as the integral of the instantaneous power loss starting at the trailing edge of the input pulse and ending at the point where the collector current equals zero ($I_{CE} = 0\text{ A}$). All devices were tested per JEDEC Standard No. 24–1 Method for Measurement of Power Device Turn-Off Switching Loss. This test method produces the true total Turn-Off Energy Loss.
- Values for two Turn-On loss conditions are shown for the convenience of the circuit designer. E_{ON1} is the turn-on loss of the IGBT only. E_{ON2} is the turn-on loss when a typical diode is used in the test circuit and the diode is at the same T_J as the IGBT. The diode type is specified in Figure 17.

HGTG30N60B3

TYPICAL PERFORMANCE CURVES

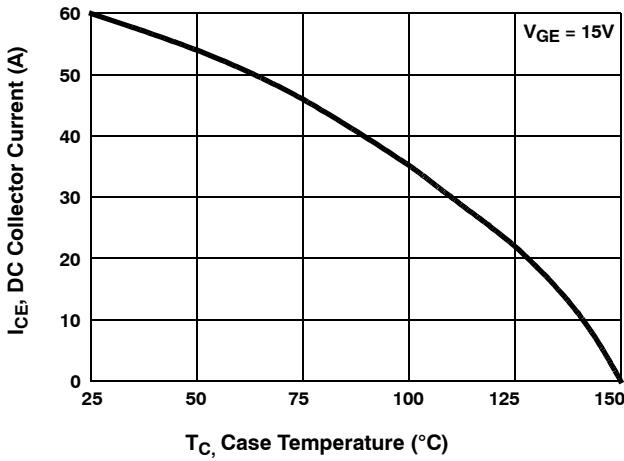

Figure 1. DC Collector Current vs. Case Temperature

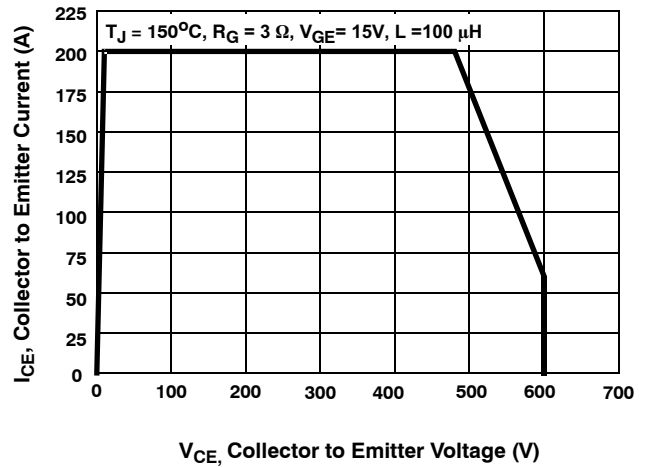

Figure 2. Minimum Switching Safe Operating Area

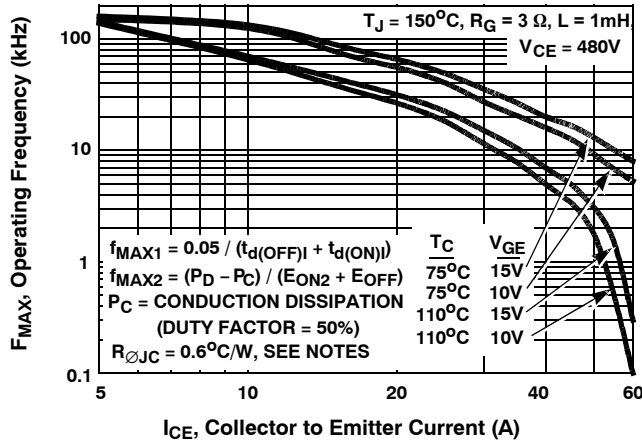

Figure 3. Operating Frequency vs. Collector to Emitter Current

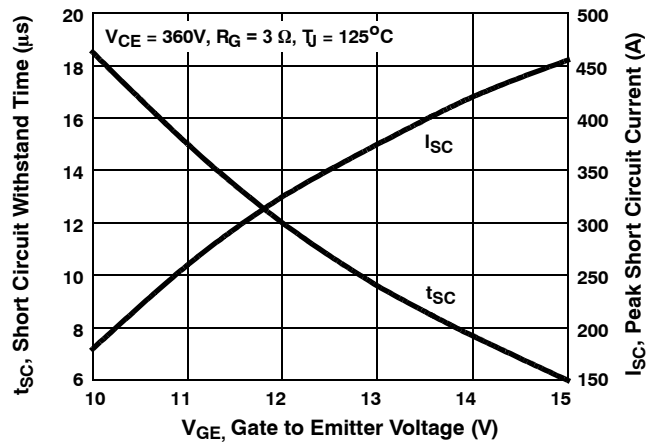

Figure 4. Short Circuit Withstand Time

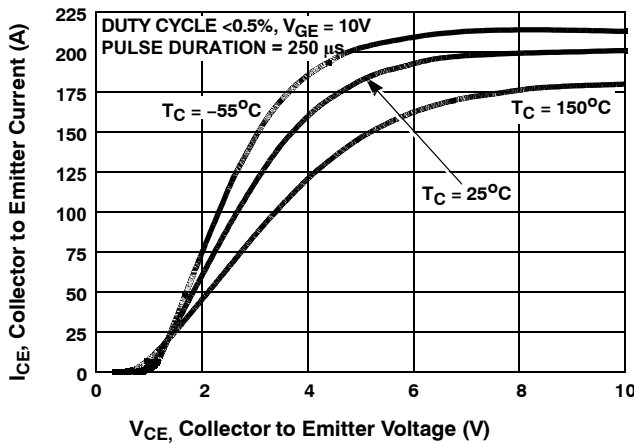

Figure 5. Collector to Emitter On-State Voltage

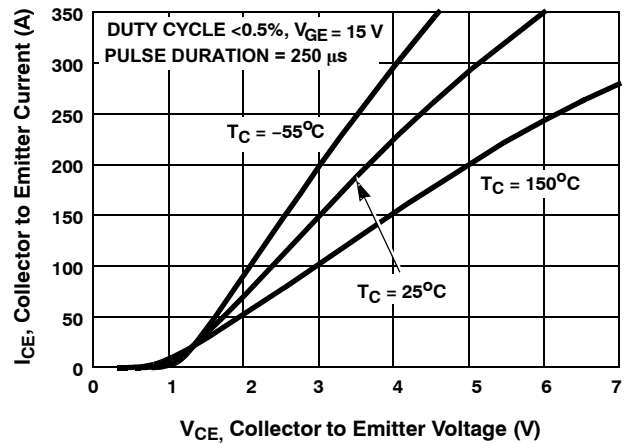

Figure 6. Collector to Emitter On-State Voltage

TYPICAL PERFORMANCE CURVES (Continued)

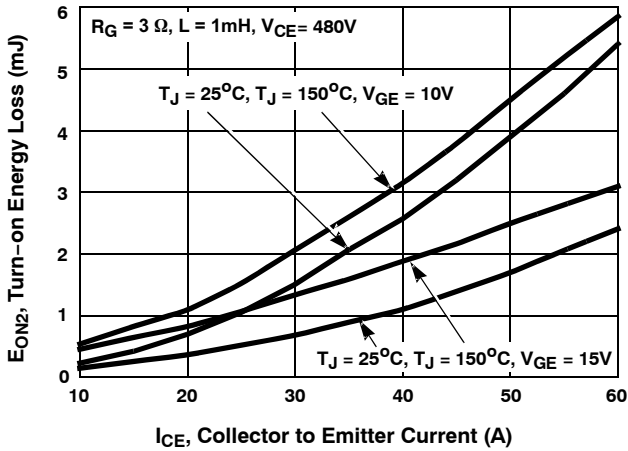

Figure 7. Turn-on Energy Loss vs. Collector to Emitter Current

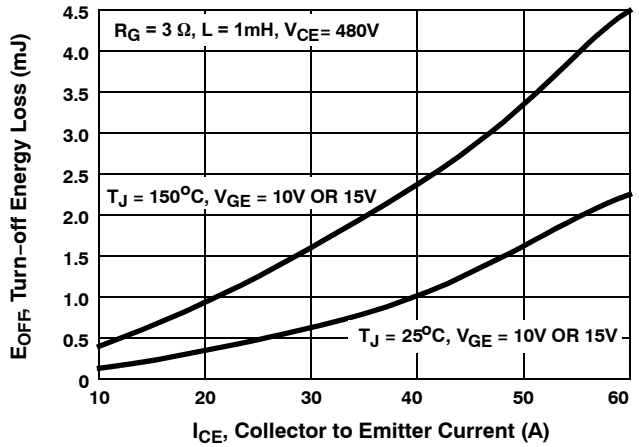

Figure 8. Turn-off Energy Loss vs. Collector to Emitter Current

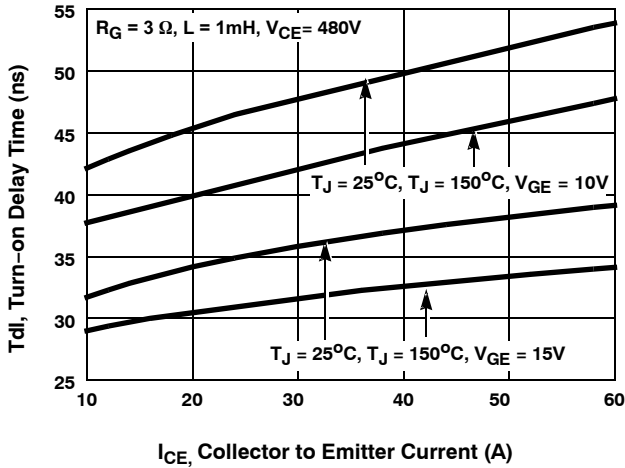

Figure 9. Turn-on Delay Time vs. Collector to Emitter Current

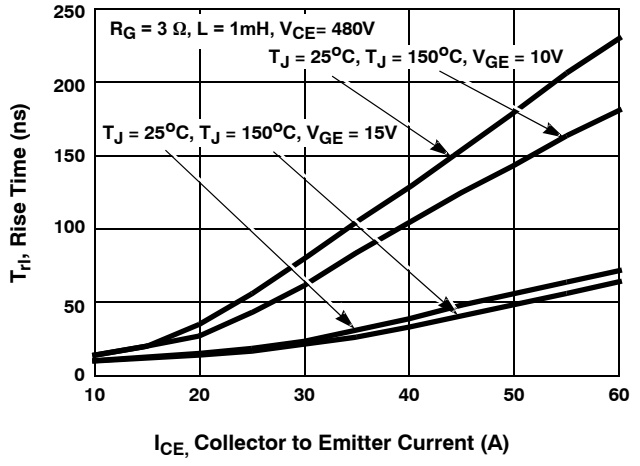

Figure 10. Turn-on Rise Time vs. Collector to Emitter Current

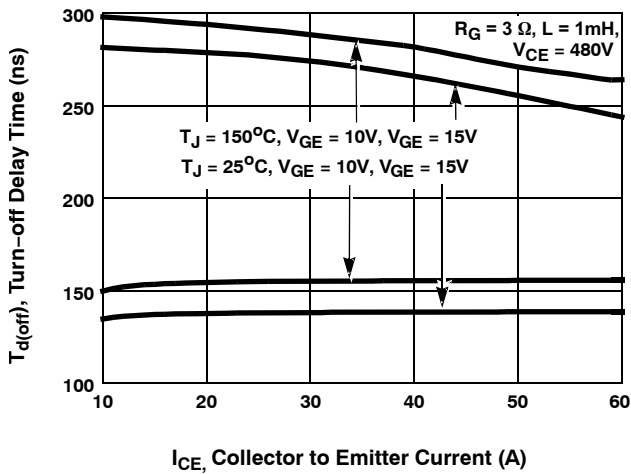

Figure 11. Turn-off Delay Time vs. Collector to Emitter Current

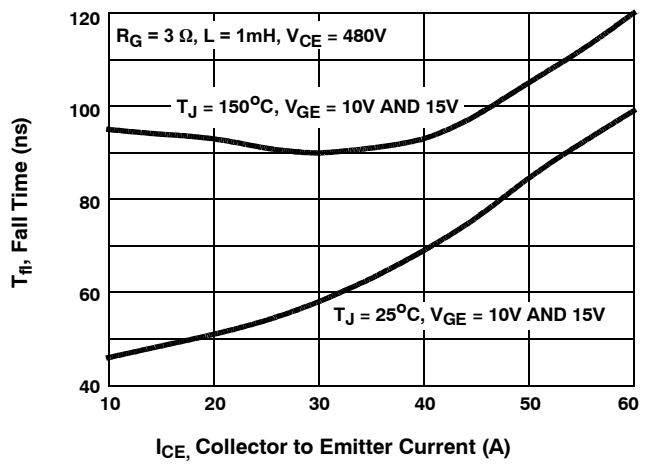

Figure 12. Fall Time vs. Collector to Emitter Current

HGTG30N60B3

TYPICAL PERFORMANCE CURVES (Continued)

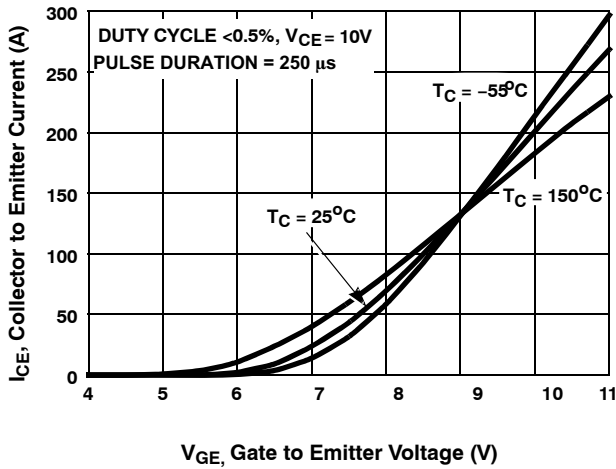

Figure 13. Transfer Characteristics

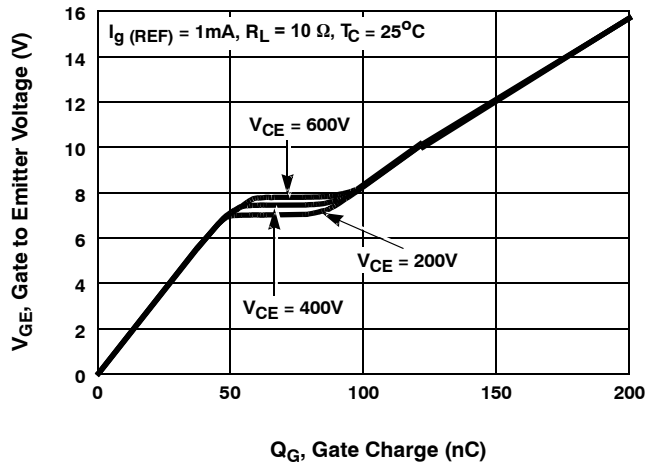

Figure 14. Gate Charge Waveforms

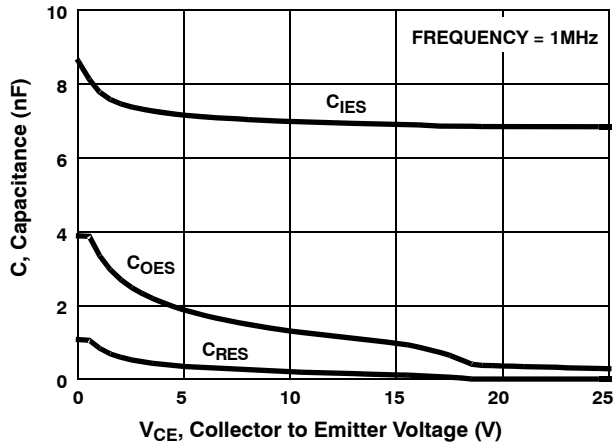

Figure 15. Capacitance vs. Collector to Emitter Voltage

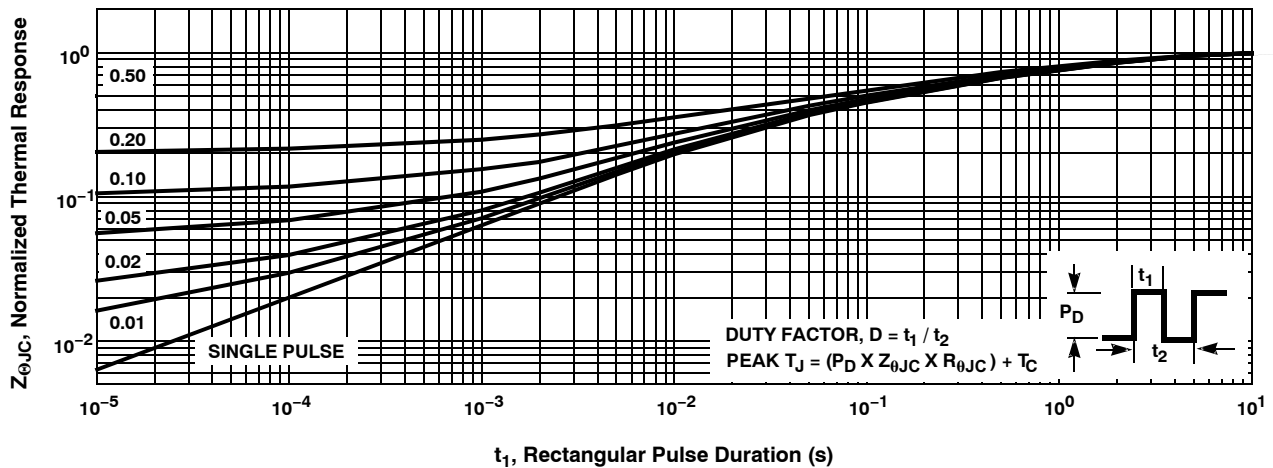

Figure 16. Normalized Transient Thermal Response, Junction to Case

HGTG30N60B3

TEST CIRCUITS AND WAVEFORMS

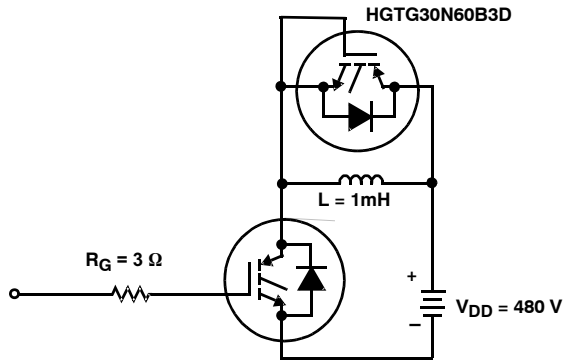

Figure 17. Inductive Switching Test Circuits

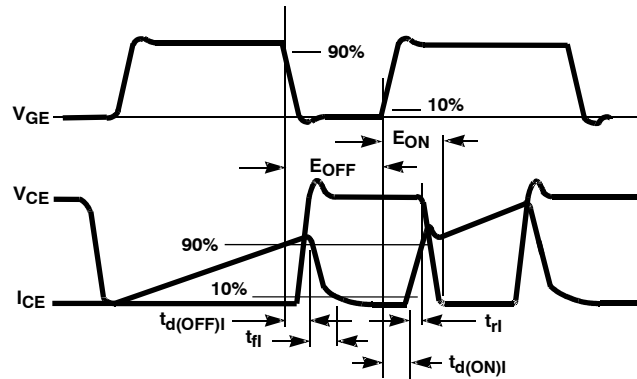

Figure 18. Switching Test Waveforms

HANDLING PRECAUTIONS FOR IGBTs

Insulated Gate Bipolar Transistors are susceptible to gate–insulation damage by the electrostatic discharge of energy through the devices. When handling these devices, care should be exercised to assure that the static charge built in the handler’s body capacitance is not discharged through the device. With proper handling and application procedures, however, IGBTs are currently being extensively used in production by numerous equipment manufacturers in military, industrial and consumer applications, with virtually no damage problems due to electrostatic discharge. IGBTs can be handled safely if the following basic precautions are taken:

1. Prior to assembly into a circuit, all leads should be kept shorted together either by the use of metal shorting springs or by the insertion into conductive material such as “ECCOSORBD™ LD26” or equivalent.
2. When devices are removed by hand from their carriers, the hand being used should be grounded by any suitable means – for example, with a metallic wristband.
3. Tips of soldering irons should be grounded.
4. Devices should never be inserted into or removed from circuits with power on.
5. Gate Voltage Rating – Never exceed the gate–voltage rating of V_{GEM} . Exceeding the rated V_{GE} can result in permanent damage to the oxide layer in the gate region.
6. Gate Termination – The gates of these devices are essentially capacitors. Circuits that leave the gate open–circuited or floating should be avoided. These conditions can result in turn on of the device due to voltage buildup on the input capacitor due to leakage currents or pickup.
7. Gate Protection – These devices do not have an internal monolithic Zener diode from gate to emitter. If gate protection is required an external Zener is recommended.

OPERATING FREQUENCY INFORMATION

Operating frequency information for a typical device (Figure 3) is presented as a guide for estimating device performance for a specific application. Other typical frequency vs collector current (I_{CE}) plots are possible using the information shown for a typical unit in Figures 5, 6, 7, 8, 9 and 11. The operating frequency plot (Figure 3) of a typical device shows f_{MAX1} or f_{MAX2} ; whichever is smaller at each point. The information is based on measurements of a typical device and is bounded by the maximum rated junction temperature.

f_{MAX1} is defined by $f_{MAX1} = 0.05 / (t_{d(OFF)I} + t_{d(ON)I})$. Deadtime (the denominator) has been arbitrarily held to 10% of the on-state time for a 50% duty factor. Other definitions are possible. $t_{d(OFF)I}$ and $t_{d(ON)I}$ are defined in Figure 18. Device turn-off delay can establish an additional frequency limiting condition for an application other than T_{JM} . $t_{d(OFF)I}$ is important when controlling output ripple under a lightly loaded condition.

f_{MAX2} is defined by $f_{MAX2} = (P_D - P_C) / (E_{OFF} + E_{ON2})$. The allowable dissipation (P_D) is defined by $P_D = (T_{JM} - T_C) / R_{\theta JC}$. The sum of device switching and conduction losses must not exceed P_D . A 50% duty factor was used (Figure 3) and the conduction losses (P_C) are approximated by $P_C = (V_{CE} \times I_{CE}) / 2$.

E_{ON2} and E_{OFF} are defined in the switching waveforms shown in Figure 18. E_{ON2} is the integral of the instantaneous power loss ($I_{CE} \times V_{CE}$) during turn-on and E_{OFF} is the integral of the instantaneous power loss ($I_{CE} \times V_{CE}$) during turn-off. All tail losses are included in the calculation for E_{OFF} ; i.e., the collector current equals zero ($I_{CE} = 0$).

TO-247-3LD SHORT LEAD
CASE 340CK
ISSUE A

DATE 31 JAN 2019



NOTES: UNLESS OTHERWISE SPECIFIED.

- A. DIMENSIONS ARE EXCLUSIVE OF BURRS, MOLD FLASH, AND TIE BAR EXTRUSIONS.
- B. ALL DIMENSIONS ARE IN MILLIMETERS.
- C. DRAWING CONFORMS TO ASME Y14.5 - 2009.
- D. DIMENSION A1 TO BE MEASURED IN THE REGION DEFINED BY L1.
- E. LEAD FINISH IS UNCONTROLLED IN THE REGION DEFINED BY L1.

GENERIC MARKING DIAGRAM*



- XXXX = Specific Device Code
- A = Assembly Location
- Y = Year
- WW = Work Week
- ZZ = Assembly Lot Code

*This information is generic. Please refer to device data sheet for actual part marking. Pb-Free indicator, "G" or microdot "•", may or may not be present. Some products may not follow the Generic Marking.

DIM	MILLIMETERS		
	MIN	NOM	MAX
A	4.58	4.70	4.82
A1	2.20	2.40	2.60
A2	1.40	1.50	1.60
b	1.17	1.26	1.35
b2	1.53	1.65	1.77
b4	2.42	2.54	2.66
c	0.51	0.61	0.71
D	20.32	20.57	20.82
D1	13.08	~	~
D2	0.51	0.93	1.35
E	15.37	15.62	15.87
E1	12.81	~	~
E2	4.96	5.08	5.20
e	~	5.56	~
L	15.75	16.00	16.25
L1	3.69	3.81	3.93
ØP	3.51	3.58	3.65
ØP1	6.60	6.80	7.00
Q	5.34	5.46	5.58
S	5.34	5.46	5.58

DOCUMENT NUMBER:	98AON13851G	Electronic versions are uncontrolled except when accessed directly from the Document Repository. Printed versions are uncontrolled except when stamped "CONTROLLED COPY" in red.
DESCRIPTION:	TO-247-3LD SHORT LEAD	PAGE 1 OF 1

ON Semiconductor and are trademarks of Semiconductor Components Industries, LLC dba ON Semiconductor or its subsidiaries in the United States and/or other countries. ON Semiconductor reserves the right to make changes without further notice to any products herein. ON Semiconductor makes no warranty, representation or guarantee regarding the suitability of its products for any particular purpose, nor does ON Semiconductor assume any liability arising out of the application or use of any product or circuit, and specifically disclaims any and all liability, including without limitation special, consequential or incidental damages. ON Semiconductor does not convey any license under its patent rights nor the rights of others.

onsemi, **Onsemi**, and other names, marks, and brands are registered and/or common law trademarks of Semiconductor Components Industries, LLC dba "**onsemi**" or its affiliates and/or subsidiaries in the United States and/or other countries. **onsemi** owns the rights to a number of patents, trademarks, copyrights, trade secrets, and other intellectual property. A listing of **onsemi**'s product/patent coverage may be accessed at www.onsemi.com/site/pdf/Patent-Marking.pdf. **onsemi** reserves the right to make changes at any time to any products or information herein, without notice. The information herein is provided "as-is" and **onsemi** makes no warranty, representation or guarantee regarding the accuracy of the information, product features, availability, functionality, or suitability of its products for any particular purpose, nor does **onsemi** assume any liability arising out of the application or use of any product or circuit, and specifically disclaims any and all liability, including without limitation special, consequential or incidental damages. Buyer is responsible for its products and applications using **onsemi** products, including compliance with all laws, regulations and safety requirements or standards, regardless of any support or applications information provided by **onsemi**. "Typical" parameters which may be provided in **onsemi** data sheets and/or specifications can and do vary in different applications and actual performance may vary over time. All operating parameters, including "Typicals" must be validated for each customer application by customer's technical experts. **onsemi** does not convey any license under any of its intellectual property rights nor the rights of others. **onsemi** products are not designed, intended, or authorized for use as a critical component in life support systems or any FDA Class 3 medical devices or medical devices with a same or similar classification in a foreign jurisdiction or any devices intended for implantation in the human body. Should Buyer purchase or use **onsemi** products for any such unintended or unauthorized application, Buyer shall indemnify and hold **onsemi** and its officers, employees, subsidiaries, affiliates, and distributors harmless against all claims, costs, damages, and expenses, and reasonable attorney fees arising out of, directly or indirectly, any claim of personal injury or death associated with such unintended or unauthorized use, even if such claim alleges that **onsemi** was negligent regarding the design or manufacture of the part. **onsemi** is an Equal Opportunity/Affirmative Action Employer. This literature is subject to all applicable copyright laws and is not for resale in any manner.

ADDITIONAL INFORMATION

TECHNICAL PUBLICATIONS:

Technical Library: www.onsemi.com/design/resources/technical-documentation
onsemi Website: www.onsemi.com

ONLINE SUPPORT: www.onsemi.com/support

For additional information, please contact your local Sales Representative at www.onsemi.com/support/sales

