

FSV530AF

Schottky Barrier Rectifier

Features

- Low Forward Voltage Drop: 0.54 V Maximum at 5 A, $T_A = 25^\circ\text{C}$
- Ultra Thin Profile – Maximum Height of 1.0 mm
- High Surge Capacity
- UL Flammability 94V-0 Classification
- MSL 1
- Green Mold Compound
- These Devices are Pb-Free, Halogen Free and are RoHS Compliant

Specifications

ABSOLUTE MAXIMUM RATINGS ($T_A = 25^\circ\text{C}$ unless otherwise noted)

Symbol	Parameter	Value	Unit
V_{RRM}	Recurrent Peak Reverse Voltage	30	V
V_{RMS}	RMS Reverse Voltage	21	V
V_R	DC Blocking Voltage	30	V
$I_{F(AV)}$	Average Forward Current	5	A
I_{FSM}	Peak Forward Surge Current: 8.3 ms Single Half Sine-Wave Superimposed on Rated Load (JEDEC Method)	100	A
T_J	Operating Junction Temperature Range	-55 to +150	$^\circ\text{C}$
T_{STG}	Storage Temperature Range	-55 to +150	$^\circ\text{C}$

Stresses exceeding those listed in the Maximum Ratings table may damage the device. If any of these limits are exceeded, device functionality should not be assumed, damage may occur and reliability may be affected.



ON Semiconductor®

www.onsemi.com

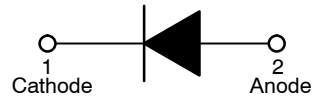

Schottky Barrier Rectifier

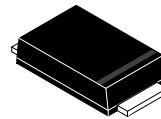

DO-214AD
(SMAF)
CASE 403AD

MARKING DIAGRAM

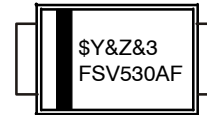

Band Indicates Cathode

\$Y = ON Semiconductor Logo
&Z = Assembly Plant Code
&3 = Data Code (Year & Week)
FSV530AF = Specific Device Code

ORDERING INFORMATION

See detailed ordering and shipping information on page 2 of this data sheet.

FSV530AF

THERMAL CHARACTERISTICS ($T_A = 25^\circ\text{C}$ unless otherwise noted) (Note 1)

Symbol	Characteristic	Value	Unit
Ψ_{JL}	Typical Thermal Characteristics, Junction-to-Lead (Note 2)	15	$^\circ\text{C}/\text{W}$
$R_{\theta JA}$	Typical Thermal Resistance, Junction-to-Ambient	120	$^\circ\text{C}/\text{W}$

1. Per JESD51-3 recommended thermal test board. Device mounted on FR-4 PCB, board size = 76.2 mm x 114.3 mm.
2. Thermocouple soldered at cathode lead.

ELECTRICAL CHARACTERISTICS ($T_A = 25^\circ\text{C}$ unless otherwise noted)

Symbol	Parameter	Conditions	Min	Typ	Max	Unit
V_F	Forward Voltage	$I_F = 5\text{ A}$	-	-	0.54	V
I_R	Reverse Current	$V_R = 30\text{ V}$	-	-	100	μA
T_{rr}	Reverse Recovery Time	$I_F = 0.5\text{ A}$, $I_R = 1\text{ A}$, $I_{rr} = 0.25\text{ A}$	-	15.72	-	ns
C_J	Junction Capacitance	$V_R = 0\text{ V}$, $f = 1\text{ MHz}$	-	159	-	pF

Product parametric performance is indicated in the Electrical Characteristics for the listed test conditions, unless otherwise noted. Product performance may not be indicated by the Electrical Characteristics if operated under different conditions.

ORDERING INFORMATION

Part Number	Top Mark	Package	Shipping†
FSV530AF	FSV530AF	DO-214AD (SMAF) (Pb-Free/Halogen Free)	10000 / Tape & Reel

†For information on tape and reel specifications, including part orientation and tape sizes, please refer to our Tape and Reel Packaging Specifications Brochure, BRD8011/D.

TYPICAL PERFORMANCE CHARACTERISTICS

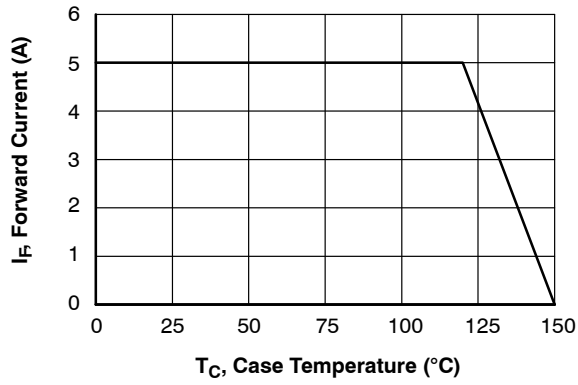

Figure 1. Forward Current Derating Curve

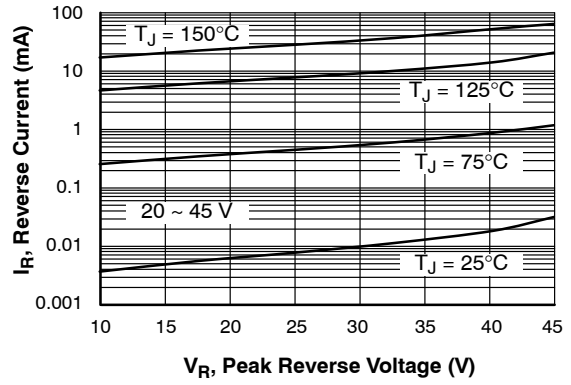

Figure 2. Typical Reverse Characteristics

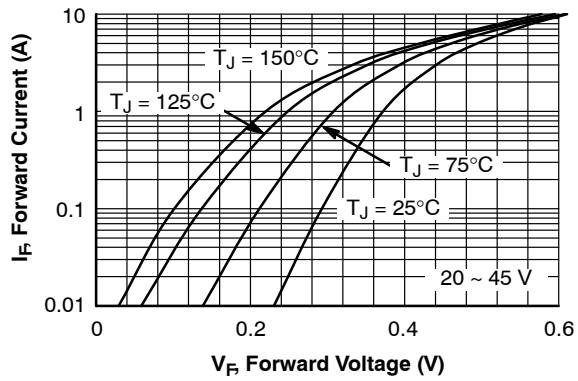

Figure 3. Typical Forward Characteristics

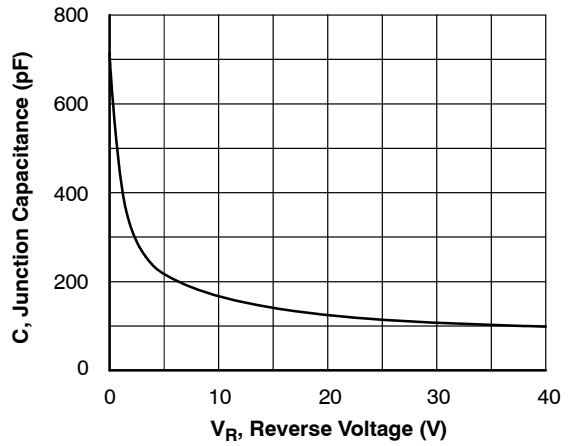
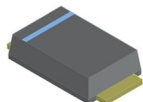

Figure 4. Typical Junction Capacitance

MECHANICAL CASE OUTLINE

PACKAGE DIMENSIONS

ON Semiconductor®



SMA-FL CASE 403AD ISSUE A

DATE 14 JUL 2020

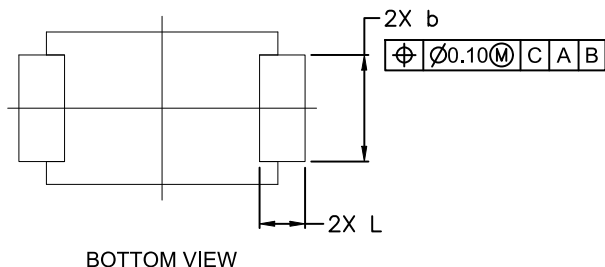
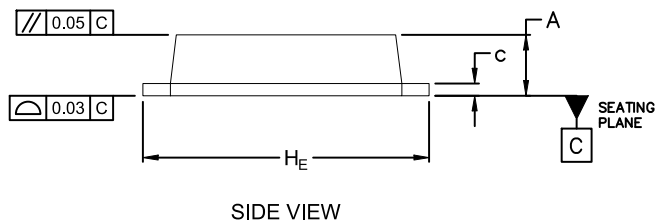
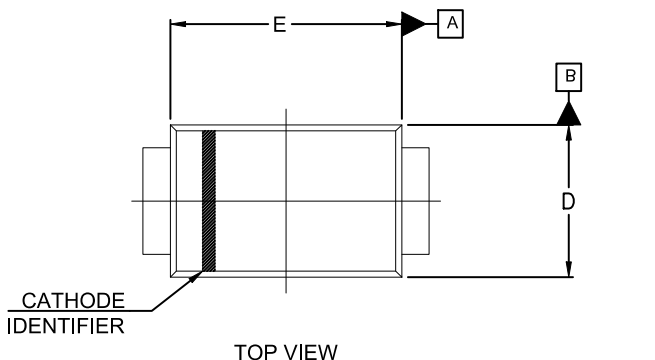

- NOTES:
1. DIMENSIONING AND TOLERANCING PER ASME Y14.5M, 2009.
 2. CONTROLLING DIMENSION: MILLIMETERS
 3. DIMENSIONS D & E ARE EXCLUSIVE OF BURRS, MOLD FLASH AND TIE BAR EXTRUSIONS.

DIM	MILLIMETERS		
	MIN.	NOM.	MAX.
A	0.90	1.00	1.10
b	1.25	1.60	1.90
c	0.10	—	0.25
D	2.30	2.50	2.70
E	3.60	3.95	4.30
H _E	4.40	4.80	5.20
L	0.50	0.75	0.95

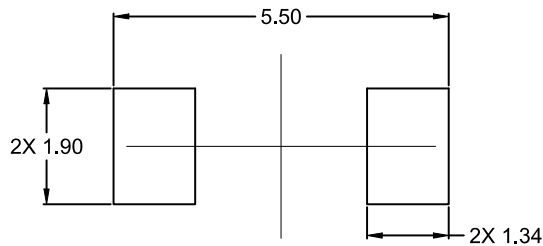

RECOMMENDED MOUNTING FOOTPRINT*

* For additional information on our Pb-Free strategy and soldering details, please download the ON Semiconductor Soldering and Mounting Techniques Reference Manual, SOLDERRM/D.

DOCUMENT NUMBER:	98AON13439G	Electronic versions are uncontrolled except when accessed directly from the Document Repository. Printed versions are uncontrolled except when stamped "CONTROLLED COPY" in red.
DESCRIPTION:	SMA-FL	PAGE 1 OF 1

ON Semiconductor and are trademarks of Semiconductor Components Industries, LLC dba ON Semiconductor or its subsidiaries in the United States and/or other countries. ON Semiconductor reserves the right to make changes without further notice to any products herein. ON Semiconductor makes no warranty, representation or guarantee regarding the suitability of its products for any particular purpose, nor does ON Semiconductor assume any liability arising out of the application or use of any product or circuit, and specifically disclaims any and all liability, including without limitation special, consequential or incidental damages. ON Semiconductor does not convey any license under its patent rights nor the rights of others.

onsemi, **Onsemi**, and other names, marks, and brands are registered and/or common law trademarks of Semiconductor Components Industries, LLC dba "**onsemi**" or its affiliates and/or subsidiaries in the United States and/or other countries. **onsemi** owns the rights to a number of patents, trademarks, copyrights, trade secrets, and other intellectual property. A listing of **onsemi**'s product/patent coverage may be accessed at www.onsemi.com/site/pdf/Patent-Marking.pdf. **onsemi** reserves the right to make changes at any time to any products or information herein, without notice. The information herein is provided "as-is" and **onsemi** makes no warranty, representation or guarantee regarding the accuracy of the information, product features, availability, functionality, or suitability of its products for any particular purpose, nor does **onsemi** assume any liability arising out of the application or use of any product or circuit, and specifically disclaims any and all liability, including without limitation special, consequential or incidental damages. Buyer is responsible for its products and applications using **onsemi** products, including compliance with all laws, regulations and safety requirements or standards, regardless of any support or applications information provided by **onsemi**. "Typical" parameters which may be provided in **onsemi** data sheets and/or specifications can and do vary in different applications and actual performance may vary over time. All operating parameters, including "Typicals" must be validated for each customer application by customer's technical experts. **onsemi** does not convey any license under any of its intellectual property rights nor the rights of others. **onsemi** products are not designed, intended, or authorized for use as a critical component in life support systems or any FDA Class 3 medical devices or medical devices with a same or similar classification in a foreign jurisdiction or any devices intended for implantation in the human body. Should Buyer purchase or use **onsemi** products for any such unintended or unauthorized application, Buyer shall indemnify and hold **onsemi** and its officers, employees, subsidiaries, affiliates, and distributors harmless against all claims, costs, damages, and expenses, and reasonable attorney fees arising out of, directly or indirectly, any claim of personal injury or death associated with such unintended or unauthorized use, even if such claim alleges that **onsemi** was negligent regarding the design or manufacture of the part. **onsemi** is an Equal Opportunity/Affirmative Action Employer. This literature is subject to all applicable copyright laws and is not for resale in any manner.

ADDITIONAL INFORMATION

TECHNICAL PUBLICATIONS:

Technical Library: www.onsemi.com/design/resources/technical-documentation
onsemi Website: www.onsemi.com

ONLINE SUPPORT: www.onsemi.com/support

For additional information, please contact your local Sales Representative at www.onsemi.com/support/sales