

# MOSFET – N-Channel QFET®

600 V, 0.2 A, 11.5 Ω

## FQT1N60CTF-WS

### Description

This N-Channel enhancement mode power MOSFET is produced using ON Semiconductor's proprietary planar stripe and DMOS technology. This advanced MOSFET technology has been especially tailored to reduce on-state resistance, and to provide superior switching performance and high avalanche energy strength. These devices are suitable for switched mode power supplies, active power factor correction (PFC), and electronic lamp ballasts.

### Features

- 0.2 A, 600 V,  $R_{DS(on)} = 9.3 \Omega$  (Typ.) @  $V_{GS} = 10 \text{ V}$ ,  $I_D = 0.1 \text{ A}$
- Low Gate Charge (Typ. 4.8 nC)
- Low  $C_{rss}$  (Typ. 3.5 pF)
- 100% Avalanche Tested
- These Devices are Pb-Free, Halogen Free/BFR Free and are RoHS Compliant

### ABSOLUTE MAXIMUM RATINGS

( $T_C = 25^\circ\text{C}$  unless otherwise noted\*)

Symbol	Parameter	Value	Unit
$V_{DSS}$	Drain to Source Voltage	600	V
$V_{GSS}$	Gate to Source Voltage	±30	V
$I_D$	Drain Current Continuous ( $T_C = 25^\circ\text{C}$ ) Continuous ( $T_C = 100^\circ\text{C}$ )	0.2 0.12	A
$I_{DM}$	Drain Current – Pulsed (Note 1)	0.8	A
$E_{AS}$	Single Pulsed Avalanche Energy (Note 2)	33	mJ
$I_{AR}$	Avalanche Current (Note 1)	0.2	A
$E_{AR}$	Repetitive Avalanche Energy (Note 1)	0.2	mJ
dv/dt	Peak Diode Recovery dv/dt (Note 3)	4.5	V/ns
$P_D$	Power Dissipation ( $T_C = 25^\circ\text{C}$ ) Derate above $25^\circ\text{C}$	2.1 0.02	W W/°C
$T_J, T_{STG}$	Operating and Storage Temperature Range	-55 to +150	°C
$T_L$	Maximum Lead Temperature for Soldering Purpose, 1/8" from Case for 5 Seconds	300	°C

Stresses exceeding those listed in the Maximum Ratings table may damage the device. If any of these limits are exceeded, device functionality should not be assumed, damage may occur and reliability may be affected.

1. Repetitive Rating: Pulse width limited by maximum junction temperature.
2.  $L = 59 \text{ mH}$ ,  $I_{AS} = 1.1 \text{ A}$ ,  $V_{DD} = 50 \text{ V}$ ,  $R_G = 25 \Omega$ , Starting  $T_J = 25^\circ\text{C}$ .
3.  $I_{SD} \leq 0.2 \text{ A}$ ,  $di/dt \leq 200 \text{ A}/\mu\text{s}$ ,  $V_{DD} \leq BV_{DSS}$ , Starting  $T_J = 25^\circ\text{C}$ .



ON Semiconductor®

[www.onsemi.com](http://www.onsemi.com)

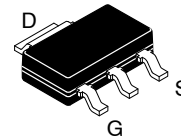

SOT-223  
CASE 318H-01

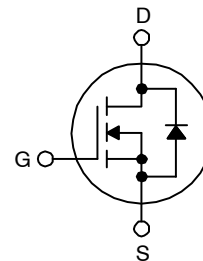

### MARKING DIAGRAM

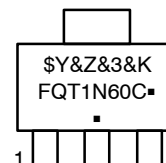

\$Y = ON Semiconductor Logo  
 &Z = Assembly Plant Code  
 &3 = 3-Digit Date Code Format  
 &K = 2-Digit Lot Run Traceability Code  
 FQT1N60C = Specific Device Code  
 ■ = Pb-Free Package

(Note: Microdot may be in either location)

### ORDERING INFORMATION

See detailed ordering and shipping information on page 6 of this data sheet.

# FQT1N60CTF-WS

## THERMAL CHARACTERISTICS

Symbol	Parameter	Min	Max	Unit
$R_{\theta JA}$	Thermal Resistance, Junction-to-Ambient*	-	60	°C/W

\*When mounted on the minimum pad size recommended (PCB Mount)

## ELECTRICAL CHARACTERISTICS (T<sub>C</sub> = 25°C, unless otherwise noted)

Symbol	Parameter	Test Conditions	Min	Typ	Max	Unit
--------	-----------	-----------------	-----	-----	-----	------

### OFF CHARACTERISTIC

$BV_{DSS}$	Drain to Source Breakdown Voltage	$I_D = 250 \mu A, V_{GS} = 0 V, T_J = 25^\circ C$	600	-	-	V
$\Delta BV_{DSS} / \Delta T_J$	Breakdown Voltage Temperature Coefficient	$I_D = 250 \mu A$ , Referenced to 25°C	-	0.6	-	V/°C
$I_{DSS}$	Zero Gate Voltage Drain Current	$V_{DS} = 600 V, V_{GS} = 0 V$	-	-	25	$\mu A$
		$V_{DS} = 480 V, T_C = 125^\circ C$	-	-	250	
$I_{GSS}$	Gate to Body Leakage Current	$V_{GS} = \pm 30 V, V_{DS} = 0 V$	-	-	$\pm 100$	nA

### ON CHARACTERISTICS

$V_{GS(th)}$	Gate Threshold Voltage	$V_{GS} = V_{DS}, I_D = 250 \mu A$	2.0	-	4.0	V
$R_{DS(on)}$	Static Drain to Source On-Resistance	$V_{GS} = 10 V, I_D = 0.1 A$	-	9.3	11.5	$\Omega$
$g_{FS}$	Forward Transconductance	$V_{DS} = 40 V, I_D = 0.1 A$ (Note 4)	-	0.75	-	S

### DYNAMIC CHARACTERISTICS

$C_{iss}$	Input Capacitance	$V_{DS} = 25 V, V_{GS} = 0 V, f = 1.0 MHz$	-	130	170	pF
$C_{oss}$	Output Capacitance		-	19	25	pF
$C_{rss}$	Reverse Transfer Capacitance		-	3.5	6	pF
$Q_g$	Total Gate Charge at 10 V	$V_{DS} = 480 V, I_D = 1 A, V_{GS} = 10 V$ (Note 4 and 5)	-	4.8	6.2	nC
$Q_{gs}$	Gate to Source Gate Charge		-	0.7	-	nC
$Q_{gd}$	Gate to Drain "Miller" Charge		-	2.7	-	nC

### SWITCHING CHARACTERISTICS

$t_{d(on)}$	Turn-On Delay Time	$V_{DD} = 300 V, I_D = 1 A, R_G = 25 \Omega$ (Note 4 and 5)	-	7	24	ns
$t_r$	Turn-On Rise Time		-	21	52	ns
$t_{d(off)}$	Turn-Off Delay Time		-	13	36	ns
$t_f$	Turn-Off Fall Time		-	27	64	ns

### DRAIN-SOURCE DIODE CHARACTERISTICS AND MAXIMUM RATINGS

$I_S$	Maximum Continuous Drain to Source Diode Forward Current	-	-	0.2	A	
$I_{SM}$	Maximum Pulsed Drain to Source Diode Forward Current	-	-	0.8	A	
$V_{SD}$	Drain to Source Diode Forward Voltage	$V_{GS} = 0 V, I_{SD} = 0.2 A$	-	-	1.4	V
$t_{rr}$	Reverse Recovery Time	$V_{GS} = 0 V, I_{SD} = 1 A, dI_F/dt = 100 A/\mu s$ (Note 4)	-	190	-	ns
$Q_{rr}$	Reverse Recovery Charge		-	0.53	-	$\mu C$

Product parametric performance is indicated in the Electrical Characteristics for the listed test conditions, unless otherwise noted. Product performance may not be indicated by the Electrical Characteristics if operated under different conditions.

- Pulse Test: Pulse width  $\leq 300 \mu s$ , Duty Cycle  $\leq 2\%$ .
- Essentially Independent of Operating Temperature Typical Characteristics.

TYPICAL CHARACTERISTICS

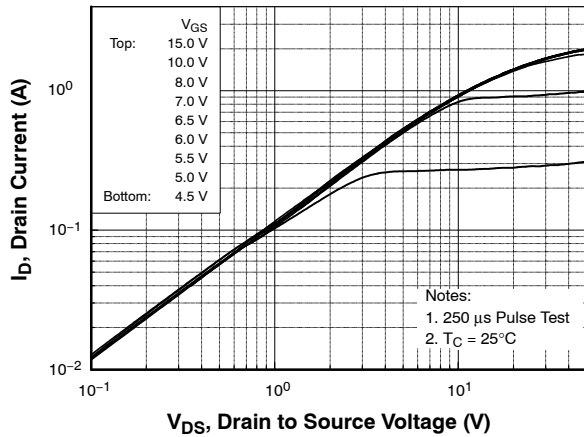

Figure 1. On-Region Characteristics

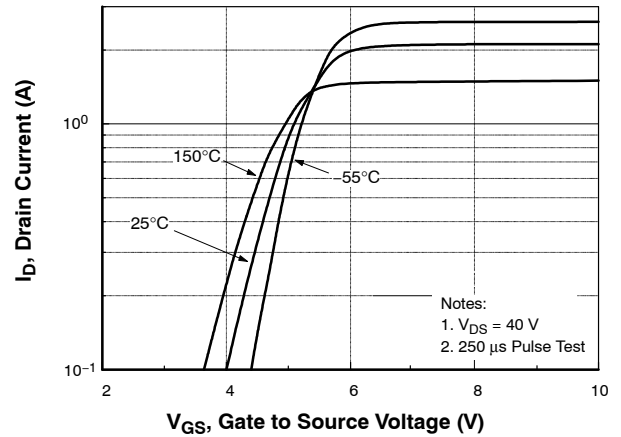

Figure 2. Transfer Characteristics

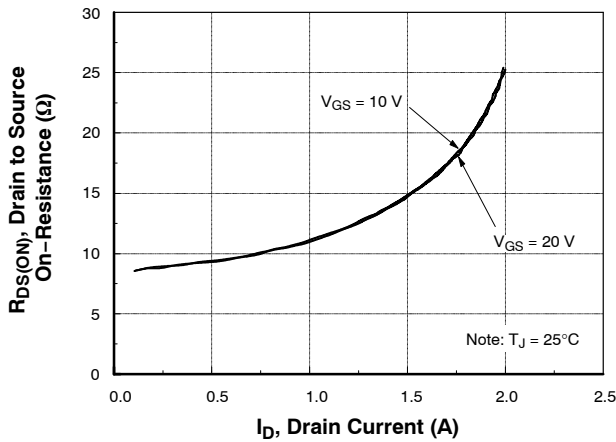

Figure 3. On-Resistance Variation vs. Drain Current and Gate Voltage

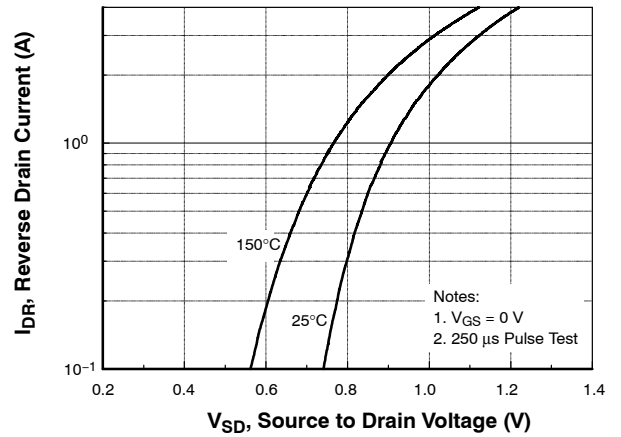

Figure 4. Body Diode Forward Voltage Variation vs. Source Current and Temperature

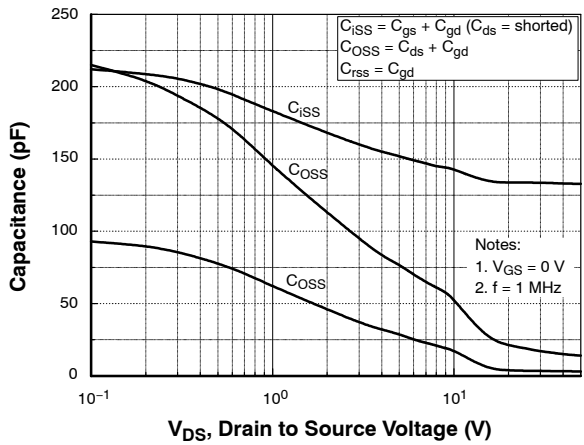

Figure 5. Capacitance Characteristics

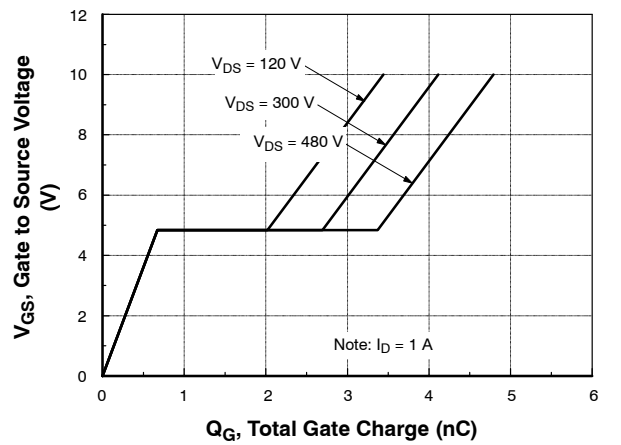

Figure 6. Gate Charge Characteristics

# FQT1N60CTF-WS

## TYPICAL CHARACTERISTICS (Continued)

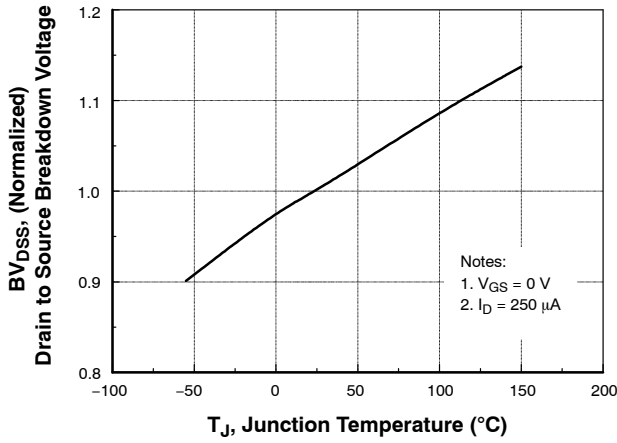

Figure 7. Breakdown Voltage Variation vs. Temperature

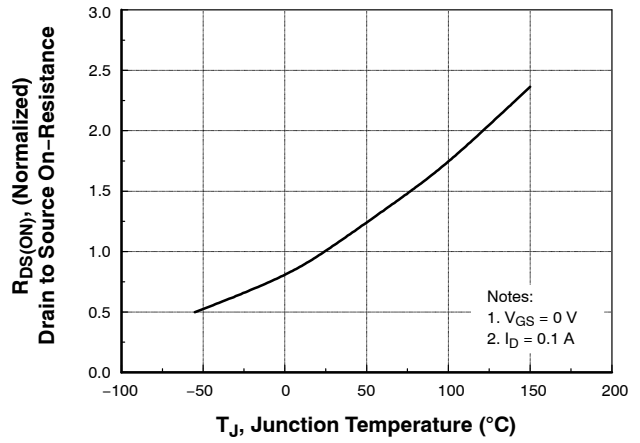

Figure 8. On-Resistance Variation vs. Temperature

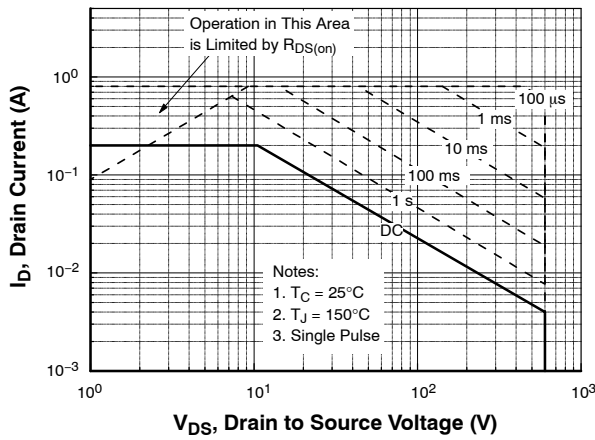

Figure 9. Maximum Safe Operating Area

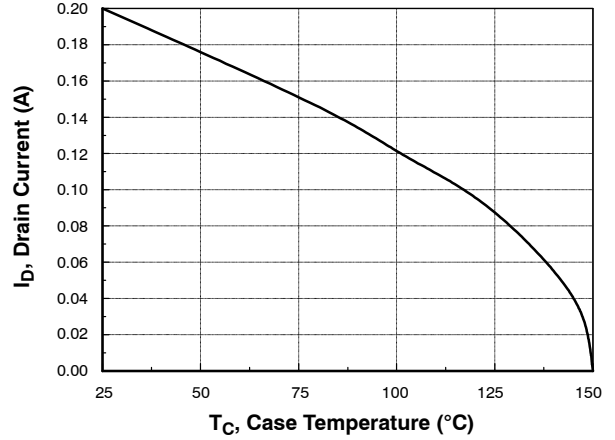

Figure 10. Maximum Drain Current vs. Case Temperature

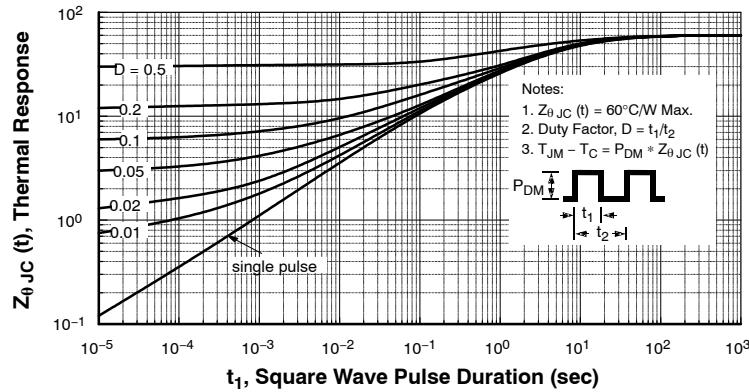

Figure 11. Transient Thermal Response Curve

# FQT1N60CTF-WS

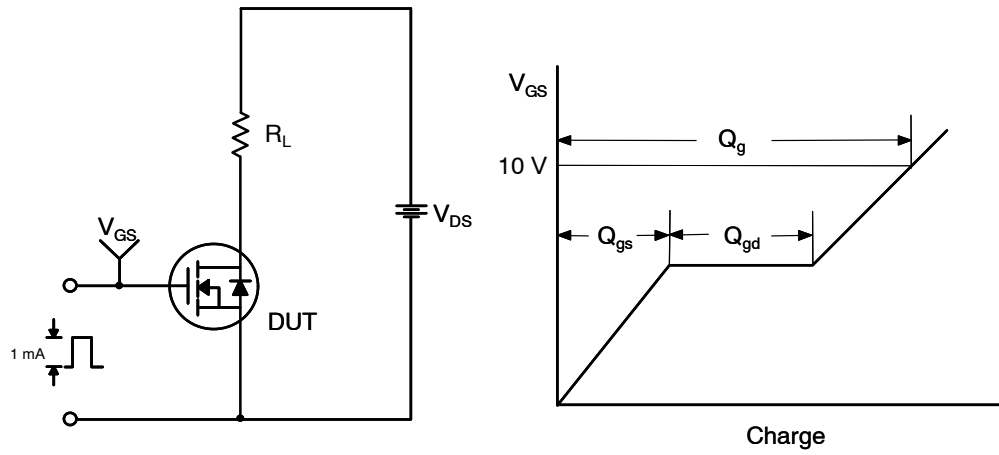

Figure 12. Gate Charge Test Circuit & Waveforms

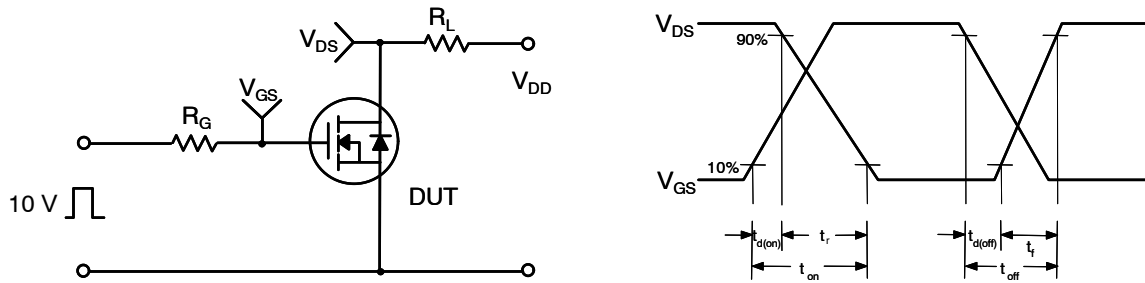

Figure 13. Resistive Switching Test Circuit & Waveforms

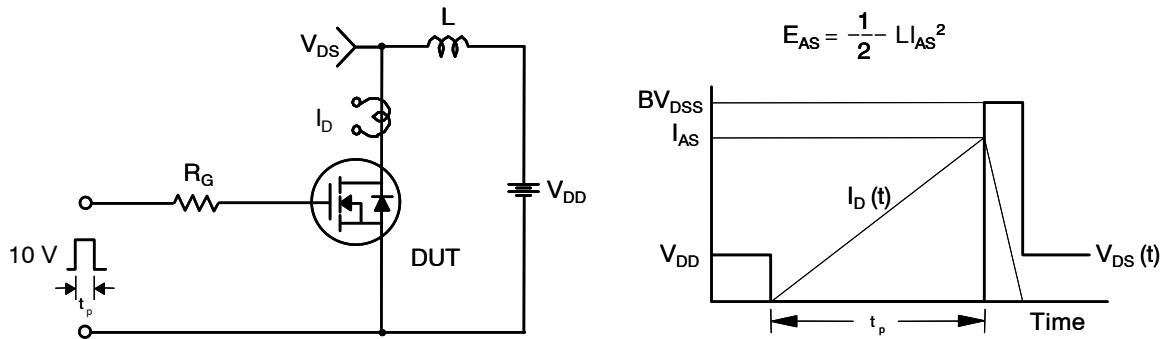
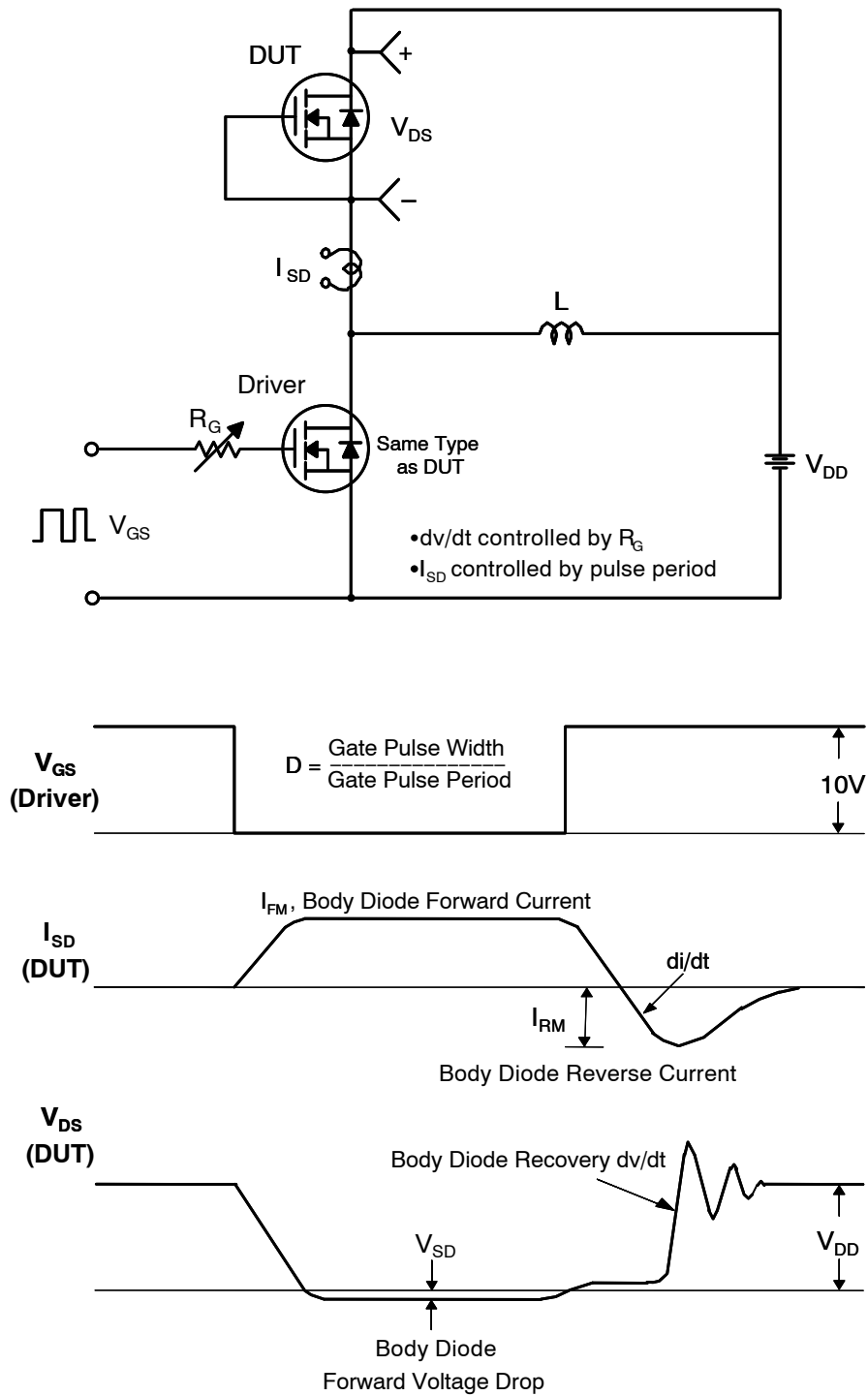

Figure 14. Unclamped Inductive Switching Test Circuit & Waveforms

## FQT1N60CTF-WS



**Figure 15. Peak Diode Recovery  $dv/dt$  Test Circuit & Waveforms**

### PACKAGE MARKING AND ORDERING INFORMATION

Device Marking	Device	Package	Reel Size	Tape Width	Quantity
FQT1N60C	FQT1N60CTF-WS	SOT-223	330 mm	12 mm	4000

†For information on tape and reel specifications, including part orientation and tape sizes, please refer to our Tape and Reel Packaging Specifications Brochure, BRD8011/D.

QFET is a registered trademark of Semiconductor Components Industries, LLC.

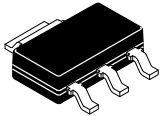

SCALE 2:1

SOT-223  
CASE 318H  
ISSUE B

DATE 13 MAY 2020

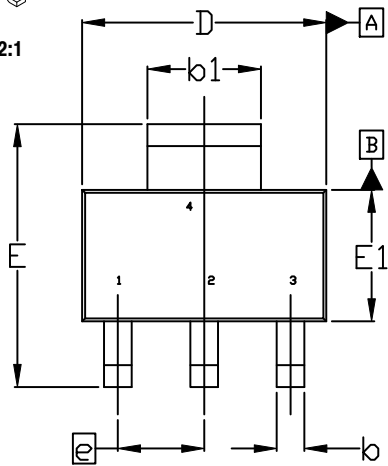

TOP VIEW

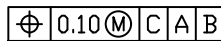

NOTE 7

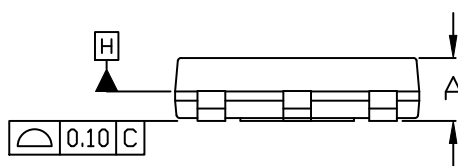

SIDE VIEW

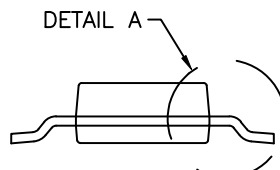

END VIEW

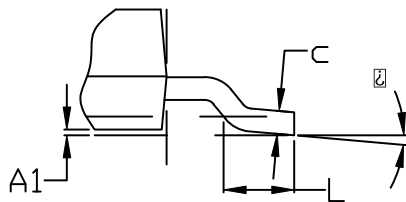

DETAIL A

NOTES:

1. DIMENSIONING AND TOLERANCING PER ASME Y14.5M, 2009.
2. CONTROLLING DIMENSION: MILLIMETERS
3. DIMENSIONS D & E1 ARE DETERMINED AT DATUM H. DIMENSIONS DO NOT INCLUDE MOLD FLASH, PROTRUSIONS OR GATE BURRS. SHALL NOT EXCEED 0.23mm PER SIDE.
4. LEAD DIMENSIONS b AND b1 DO NOT INCLUDE DAMBAR PROTRUSION. ALLOWABLE DAMBAR PROTRUSION IS 0.08mm PER SIDE.
5. DATUMS A AND B ARE DETERMINED AT DATUM H.
6. A1 IS DEFINED AS THE VERTICAL DISTANCE FROM THE SEATING PLANE TO THE LOWEST POINT OF THE PACKAGE BODY.
7. POSITIONAL TOLERANCE APPLIES TO DIMENSIONS b AND b1.

DIM	MILLIMETERS		
	MIN.	NOM.	MAX.
A	---	---	1.80
A1	0.02	0.06	0.11
b	0.60	0.74	0.88
b1	2.90	3.00	3.10
c	0.24	---	0.35
D	6.30	6.50	6.70
E	6.70	7.00	7.30
E1	3.30	3.50	3.70
e	2.30 BSC		
L	0.25	---	---
$\text{M}$	0°	---	10°

GENERIC MARKING DIAGRAM\*

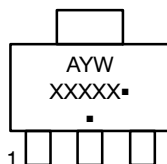

- A = Assembly Location
- Y = Year
- W = Work Week
- XXXXX = Specific Device Code
- = Pb-Free Package

(Note: Microdot may be in either location)

\*This information is generic. Please refer to device data sheet for actual part marking. Pb-Free indicator, "G" or microdot "▪", may or may not be present. Some products may not follow the Generic Marking.

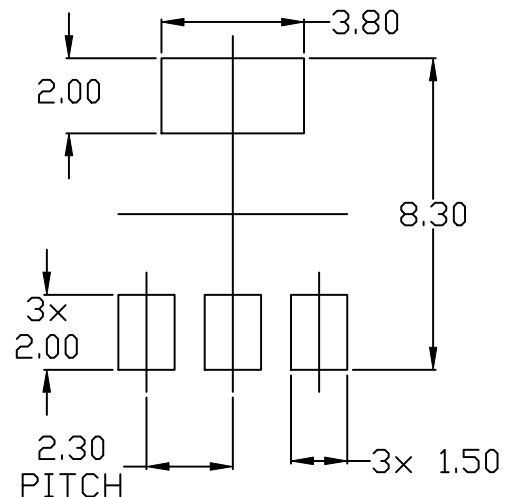

RECOMMENDED MOUNTING FOOTPRINT

\* For additional information on our Pb-Free strategy and soldering details, please download the ON Semiconductor Soldering and Mounting Techniques Reference Manual, SOLDERM/D.

DOCUMENT NUMBER:	98ASH70634A	Electronic versions are uncontrolled except when accessed directly from the Document Repository. Printed versions are uncontrolled except when stamped "CONTROLLED COPY" in red.
DESCRIPTION:	SOT-223	PAGE 1 OF 1

onsemi and ONSEMI are trademarks of Semiconductor Components Industries, LLC dba onsemi or its subsidiaries in the United States and/or other countries. onsemi reserves the right to make changes without further notice to any products herein. onsemi makes no warranty, representation or guarantee regarding the suitability of its products for any particular purpose, nor does onsemi assume any liability arising out of the application or use of any product or circuit, and specifically disclaims any and all liability, including without limitation special, consequential or incidental damages. onsemi does not convey any license under its patent rights nor the rights of others.

**onsemi**, **Onsemi**, and other names, marks, and brands are registered and/or common law trademarks of Semiconductor Components Industries, LLC dba "**onsemi**" or its affiliates and/or subsidiaries in the United States and/or other countries. **onsemi** owns the rights to a number of patents, trademarks, copyrights, trade secrets, and other intellectual property. A listing of **onsemi**'s product/patent coverage may be accessed at [www.onsemi.com/site/pdf/Patent-Marking.pdf](http://www.onsemi.com/site/pdf/Patent-Marking.pdf). **onsemi** reserves the right to make changes at any time to any products or information herein, without notice. The information herein is provided "as-is" and **onsemi** makes no warranty, representation or guarantee regarding the accuracy of the information, product features, availability, functionality, or suitability of its products for any particular purpose, nor does **onsemi** assume any liability arising out of the application or use of any product or circuit, and specifically disclaims any and all liability, including without limitation special, consequential or incidental damages. Buyer is responsible for its products and applications using **onsemi** products, including compliance with all laws, regulations and safety requirements or standards, regardless of any support or applications information provided by **onsemi**. "Typical" parameters which may be provided in **onsemi** data sheets and/or specifications can and do vary in different applications and actual performance may vary over time. All operating parameters, including "Typicals" must be validated for each customer application by customer's technical experts. **onsemi** does not convey any license under any of its intellectual property rights nor the rights of others. **onsemi** products are not designed, intended, or authorized for use as a critical component in life support systems or any FDA Class 3 medical devices or medical devices with a same or similar classification in a foreign jurisdiction or any devices intended for implantation in the human body. Should Buyer purchase or use **onsemi** products for any such unintended or unauthorized application, Buyer shall indemnify and hold **onsemi** and its officers, employees, subsidiaries, affiliates, and distributors harmless against all claims, costs, damages, and expenses, and reasonable attorney fees arising out of, directly or indirectly, any claim of personal injury or death associated with such unintended or unauthorized use, even if such claim alleges that **onsemi** was negligent regarding the design or manufacture of the part. **onsemi** is an Equal Opportunity/Affirmative Action Employer. This literature is subject to all applicable copyright laws and is not for resale in any manner.

## ADDITIONAL INFORMATION

### TECHNICAL PUBLICATIONS:

Technical Library: [www.onsemi.com/design/resources/technical-documentation](http://www.onsemi.com/design/resources/technical-documentation)  
onsemi Website: [www.onsemi.com](http://www.onsemi.com)

### ONLINE SUPPORT: [www.onsemi.com/support](http://www.onsemi.com/support)

For additional information, please contact your local Sales Representative at [www.onsemi.com/support/sales](http://www.onsemi.com/support/sales)