

Thank you for your interest in **onsemi** products.  
Your technical document begins on the following pages.



## Your Feedback is Important to Us!

Please take a moment to participate in our short survey.  
At **onsemi**, we are dedicated to delivering technical content that best meets your needs.

### [Help Us Improve – Take the Survey](#)

This survey is intended to collect your feedback, capture any issues you may encounter, and to provide improvements you would like to suggest.

**We look forward to your feedback.**

To learn more about **onsemi**, please visit our website at  
[www.onsemi.com](http://www.onsemi.com)

**onsemi** and **onsemi** and other names, marks, and brands are registered and/or common law trademarks of Semiconductor Components Industries, LLC dba "**onsemi**" or its affiliates and/or subsidiaries in the United States and/or other countries. **onsemi** owns the rights to a number of patents, trademarks, copyrights, trade secrets, and other intellectual property. A listing of **onsemi** product/patent coverage may be accessed at [www.onsemi.com/site/pdf/Patent-Marking.pdf](http://www.onsemi.com/site/pdf/Patent-Marking.pdf). **onsemi** reserves the right to make changes at any time to any products or information herein, without notice. The information herein is provided "as-is" and **onsemi** makes no warranty, representation or guarantee regarding the accuracy of the information, product features, availability, functionality, or suitability of its products for any particular purpose, nor does **onsemi** assume any liability arising out of the application or use of any product or circuit, and specifically disclaims any and all liability, including without limitation special, consequential or incidental damages. Buyer is responsible for its products and applications using **onsemi** products, including compliance with all laws, regulations and safety requirements or standards, regardless of any support or applications information provided by **onsemi**. "Typical" parameters which may be provided in **onsemi** data sheets and/or specifications can and do vary in different applications and actual performance may vary over time. All operating parameters, including "Typicals" must be validated for each customer application by customer's technical experts. **onsemi** does not convey any license under any of its intellectual property rights nor the rights of others. **onsemi** products are not designed, intended, or authorized for use as a critical component in life support systems or any FDA Class 3 medical devices or medical devices with a same or similar classification in a foreign jurisdiction or any devices intended for implantation in the human body. Should Buyer purchase or use **onsemi** products for any such unintended or unauthorized application, Buyer shall indemnify and hold **onsemi** and its officers, employees, subsidiaries, affiliates, and distributors harmless against all claims, costs, damages, and expenses, and reasonable attorney fees arising out of, directly or indirectly, any claim of personal injury or death associated with such unintended or unauthorized use, even if such claim alleges that **onsemi** was negligent regarding the design or manufacture of the part. **onsemi** is an Equal Opportunity/Affirmative Action Employer. This literature is subject to all applicable copyright laws and is not for resale in any manner. Other names and brands may be claimed as the property of others.

# MOSFET – N-Channel POWERTRENCH®

**30 V, 8.5 A, 23 mΩ**

## FDS8884

### Description

This N-Channel MOSFET has been Designed Specifically to improve the overall efficiency of DC/DC Converters using either synchronous or conventional switching PWM controllers. It has been optimized for low gate charge, low  $R_{DS(on)}$  and fast switching speed.

### Features

- Max  $R_{DS(on)}$  = 23 mΩ at  $V_{GS} = 10\text{ V}$ ,  $I_D = 8.5\text{ A}$
- Max  $R_{DS(on)}$  = 30 mΩ at  $V_{GS} = 4.5\text{ V}$ ,  $I_D = 7.5\text{ A}$
- Low Gate Charge
- 100%  $R_G$  Tested
- These Device is Pb-Free and RoHS Compliant

### MOSFET MAXIMUM RATINGS $T_A = 25^\circ\text{C}$ unless otherwise noted

Symbol	Parameter	Value	Unit
$V_{DS}$	Drain to Source Voltage	100	V
$V_{GS}$	Gate to Source Voltage	$\pm 20$	V
$I_D$	Drain Current Continuous (Note 1a) Pulsed	8.5	A
		40	
$E_{AS}$	Single Pulse Avalanche Energy (Note 2)	32	mJ
$P_D$	Power Dissipation $T_C = 25^\circ\text{C}$	2.5	W
	Derate Above $25^\circ\text{C}$	20	mW/ $^\circ\text{C}$
$T_J, T_{stg}$	Operating and Storage Junction Temperature Range	-55 to +150	$^\circ\text{C}$

Stresses exceeding those listed in the Maximum Ratings table may damage the device. If any of these limits are exceeded, device functionality should not be assumed, damage may occur and reliability may be affected.

### THERMAL CHARACTERISTICS

Symbol	Parameter	Value	Unit
$R_{\theta JC}$	Thermal Resistance Junction to Ambient (Note 1a)	50	$^\circ\text{C}/\text{W}$
$R_{\theta JA}$	Thermal Resistance, Junction to Case (Note 1)	25	

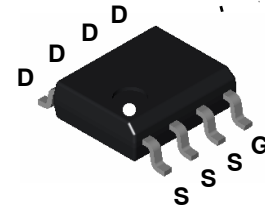

SOIC8,  
CASE 751EB

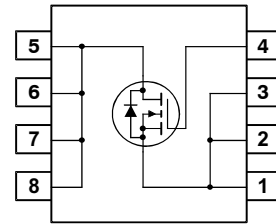

### MARKING DIAGRAM

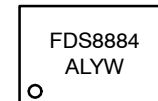

FDS8884 = Specific Device Code  
A = Assembly Location  
L = Lot Traceability Code  
YW = Date Code (Year and Week)

### ORDERING INFORMATION

Device	Package	Shipping†
FDS8884	SO-8 (Pb-Free)	2500 / Tape & Reel

†For information on tape and reel specifications, including part orientation and tape sizes, please refer to our Tape and Reel Packaging Specifications Brochure, [BRD8011/D](#).

# FDS8884

## ELECTRICAL CHARACTERISTICS $T_J = 25^\circ\text{C}$ unless otherwise noted

Symbol	Parameter	Test Conditions	Min	Typ	Max	Unit
<b>Off Characteristics</b>						
$BV_{DSS}$	Drain to Source Breakdown Voltage	$I_D = 250 \mu\text{A}$ , $V_{GS} = 0 \text{ V}$	30	–	–	V
$\frac{\Delta BV_{DSS}}{\Delta T_J}$	Breakdown Voltage Temperature Coefficient	$I_D = 250 \mu\text{A}$ , Referenced to $25^\circ\text{C}$	–	23	–	$\text{mV}/^\circ\text{C}$
$I_{DSS}$	Zero Gate Voltage Drain Current	$V_{DS} = 24 \text{ V}$ $V_{GS} = 0 \text{ V}$ , $T_J = 125^\circ\text{C}$	–	–	1 250	$\mu\text{A}$
$I_{GSS}$	Gate to Source Leakage Current	$V_{GS} = \pm 20 \text{ V}$	–	–	$\pm 100$	nA

### On Characteristics (Note 3)

$V_{GS(th)}$	Gate to Source Threshold Voltage	$V_{GS} = V_{DS}$ , $I_D = 250 \mu\text{A}$	1.2	1.7	2.5	V
$\frac{\Delta V_{GS(th)}}{\Delta T_J}$	Gate to Source Threshold Voltage Temperature Coefficient	$I_D = 380 \mu\text{A}$ , Referenced to $25^\circ\text{C}$	–	–4.9	–	$\text{mV}/^\circ\text{C}$
$R_{DS(on)}$	Drain to Source On-Resistance	$V_{GS} = 10 \text{ V}$ , $I_D = 8.5 \text{ A}$	–	19	23	m $\Omega$
		$V_{GS} = 4.5 \text{ V}$ , $I_D = 7.5 \text{ A}$	–	23	30	
		$V_{GS} = 10 \text{ V}$ , $I_D = 8.5 \text{ A}$ , $T_J = 125^\circ\text{C}$	–	26	32	

### Dynamic Characteristics

$C_{iss}$	Input Capacitance	$V_{DS} = 15 \text{ V}$ , $V_{GS} = 0 \text{ V}$ , $f = 1 \text{ MHz}$	–	475	635	pF
$C_{oss}$	Output Capacitance		–	100	135	pF
$C_{rss}$	Reverse Transfer Capacitance		–	65	100	pF
$R_g$	Gate Resistance	$f = 1 \text{ MHz}$	–	0.9	1.6	$\Omega$

### Switching Characteristics (Note 3)

$t_{d(on)}$	Turn-On Delay Time	$V_{DD} = 15 \text{ V}$ , $I_D = 8.5 \text{ A}$ , $V_{GS} = 10 \text{ V}$ , $R_{GS} = 32 \Omega$	–	5	10	ns
$t_r$	Rise Time		–	9	18	ns
$t_{d(off)}$	Turn-Off Delay Time		–	42	68	ns
$t_f$	Fall Time		–	21	34	ns
$Q_g$	Total Gate Charge	$V_{DS} = 15 \text{ V}$ , $V_{GS} = 10 \text{ V}$ , $I_D = 8.5 \text{ A}$	–	9.2	13	nC
$Q_g$	Total Gate Charge	$V_{DS} = 15 \text{ V}$ , $V_{GS} = 5 \text{ V}$ , $I_D = 8.5 \text{ A}$	–	5.0	7	nC
$Q_{gs}$	Gate to Source Gate Charge		–	1.5	–	nC
$Q_{gd}$	Gate to Drain Charge		–	2.0	–	nC

### Drain-Source Diode Characteristics and Maximum Ratings

$V_{SD}$	Source to Drain Diode Forward Voltage	$I_{SD} = 8.5 \text{ A}$	–	0.9	1.25	V
		$I_{SD} = 2.1 \text{ A}$	–	0.8	1.0	V
$t_{rr}$	Reverse Recovery Time	$I_F = 8.5 \text{ A}$ , $di/dt = 100 \text{ A}/\mu\text{s}$	–	–	33	ns
$Q_{rr}$	Reverse Recovery Charge		–	–	20	nC

Product parametric performance is indicated in the Electrical Characteristics for the listed test conditions, unless otherwise noted. Product performance may not be indicated by the Electrical Characteristics if operated under different conditions.

#### NOTES:

- $R_{\theta JA}$  is the sum of the junction-to-case and case-to-ambient thermal resistance where the case thermal reference is defined as the solder mounting surface of the drain pins.  $R_{\theta JC}$  is guaranteed by design while  $R_{\theta CA}$  is determined by the user's board design.

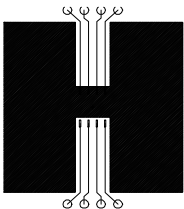

Scale 1 : 1 on letter size paper

a).  $50^\circ\text{C}/\text{W}$  when mounted on a  $1 \text{ in}^2$  pad of 2 oz copper.

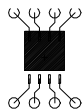

b).  $105^\circ\text{C}/\text{W}$  when mounted on a  $0.4 \text{ in}^2$  pad of 2 oz copper.

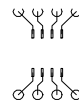

c).  $125^\circ\text{C}/\text{W}$  when mounted on a minimum pad

- Starting  $T_J = 25^\circ\text{C}$ ,  $L = 1 \text{ mH}$ ,  $I_{AS} = 8 \text{ A}$ ,  $V_{DD} = 27 \text{ V}$ ,  $V_{GS} = 10 \text{ V}$ .
- Pulse Test: Pulse Width  $\leq 300 \mu\text{s}$ , Duty Cycle  $\leq 2.0\%$ .

TYPICAL CHARACTERISTICS

( $T_J = 25^\circ\text{C}$  unless otherwise noted)

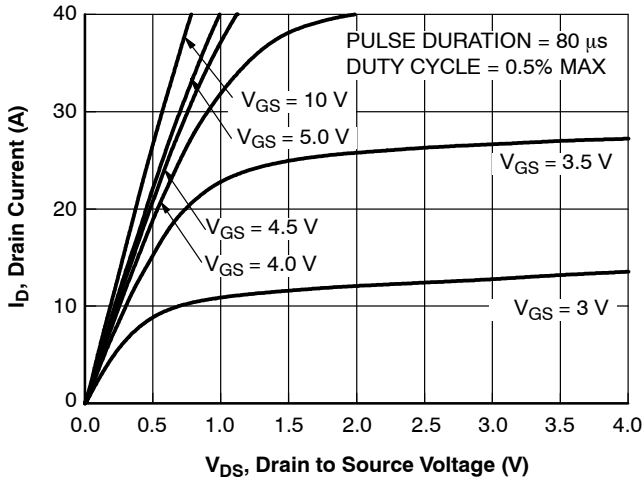

Figure 1. On-Region Characteristics

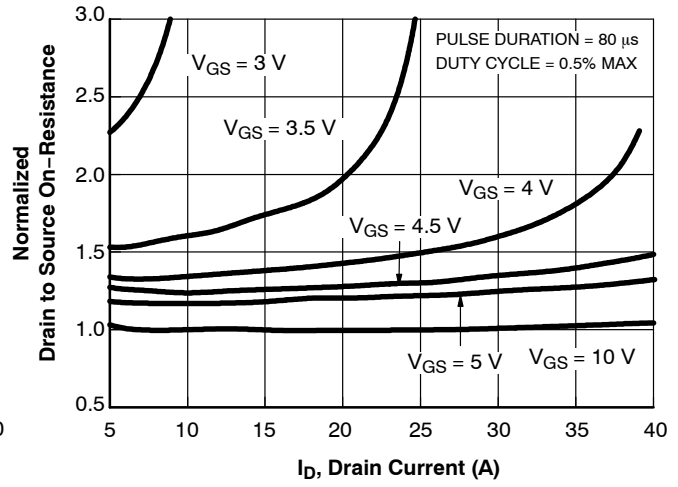

Figure 2. Normalized On-Resistance vs. Drain Current and Gate Voltage

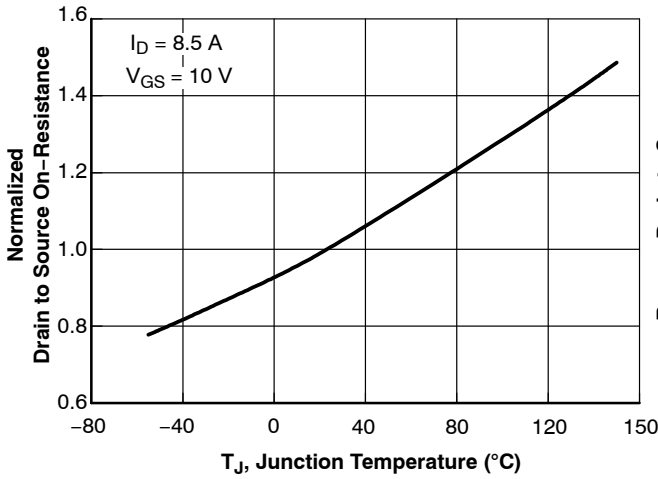

Figure 3. Normalized On-Resistance vs. Junction Temperature

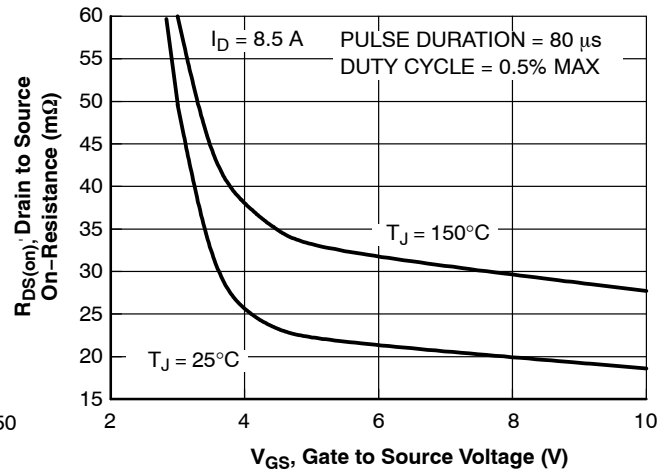

Figure 4. On-Resistance vs. Gate to Source Voltage

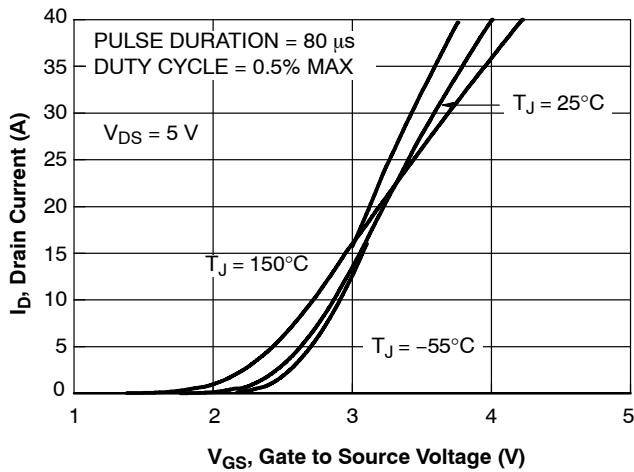

Figure 5. Transfer Characteristics

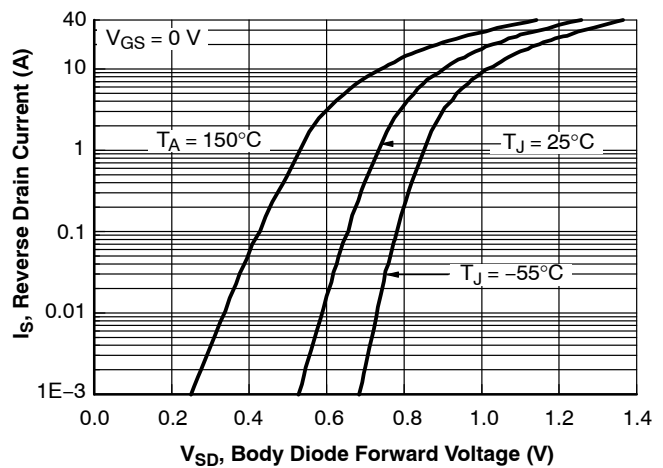

Figure 6. Source to Drain Diode Forward Voltage vs. Source Current

TYPICAL CHARACTERISTICS

( $T_J = 25^\circ\text{C}$  unless otherwise noted) (CONTINUED)

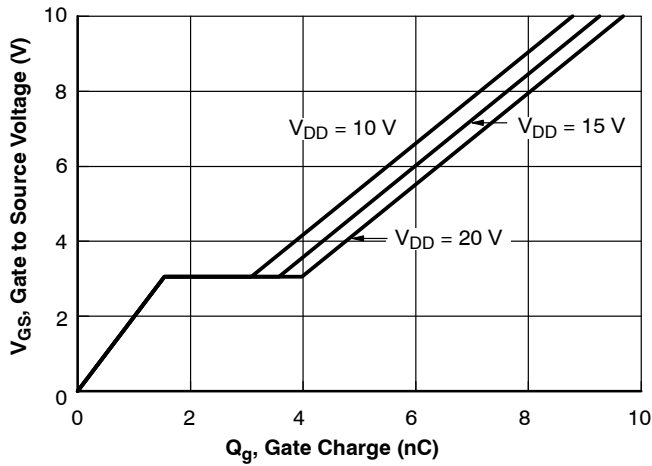

Figure 7. Gate Charge Characteristics

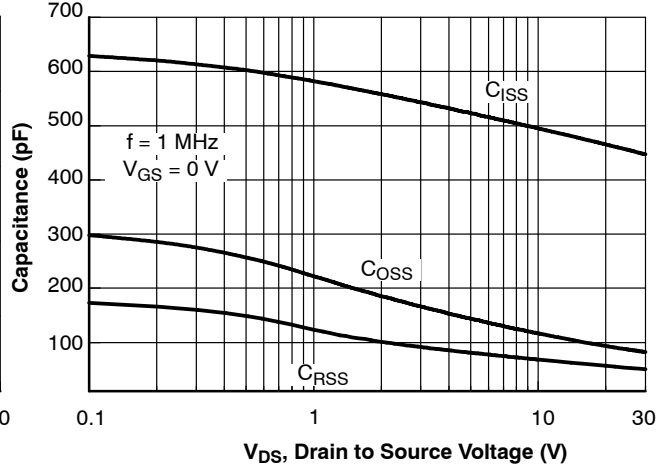

Figure 8. Capacitance vs Drain to Source Voltage

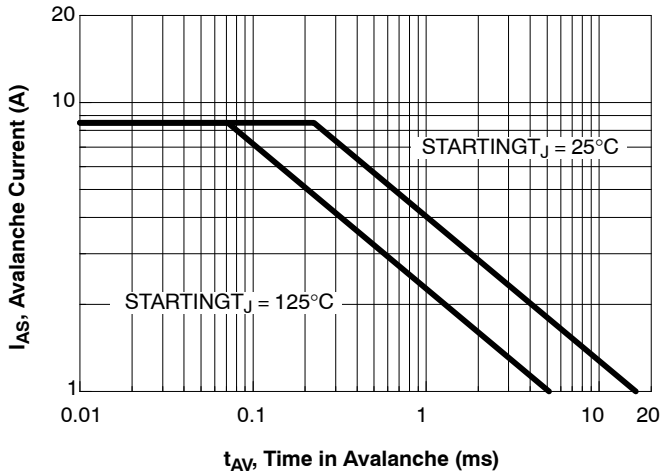

Figure 9. Unclamped Inductive Switching Capability

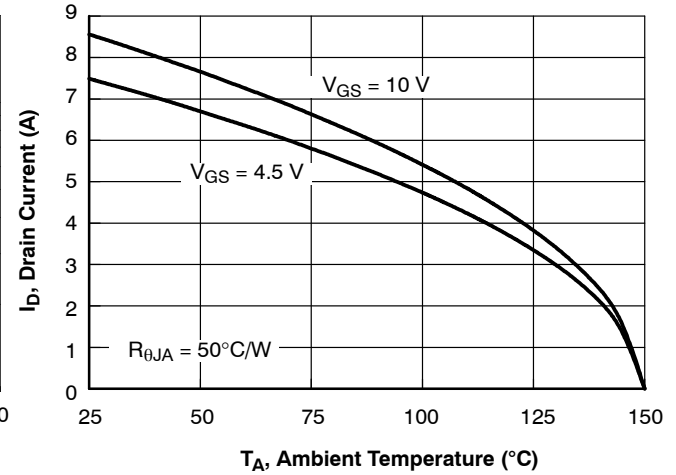

Figure 10. Maximum Continuous Drain Current vs. Ambient Temperature

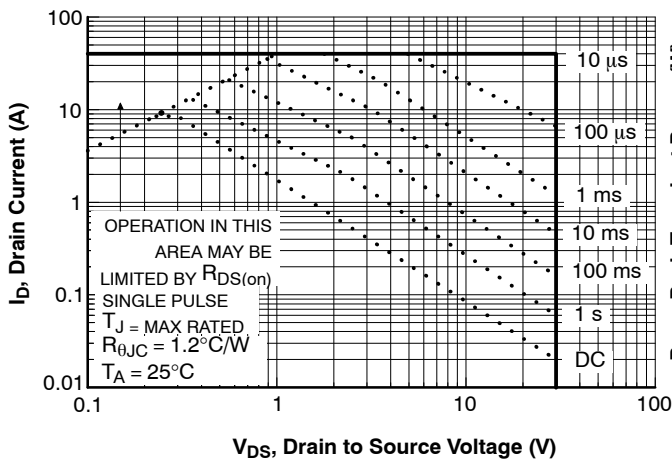

Figure 11. Forward Bias Safe Operating Area

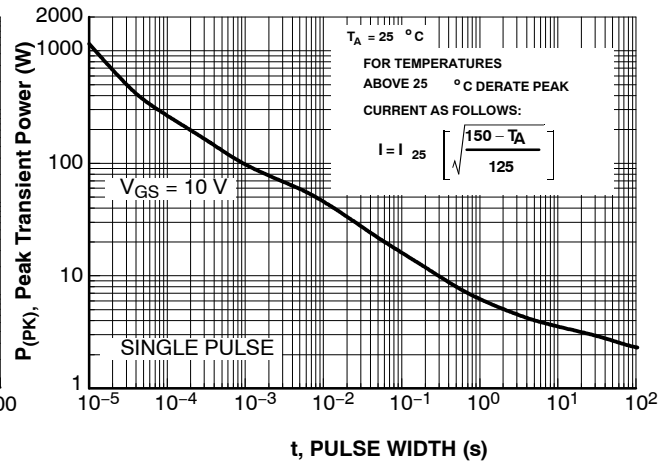

Figure 12. Single Pulse Maximum Power Dissipation

TYPICAL CHARACTERISTICS

( $T_J = 25\text{ }^\circ\text{C}$  unless otherwise noted) (CONTINUED)

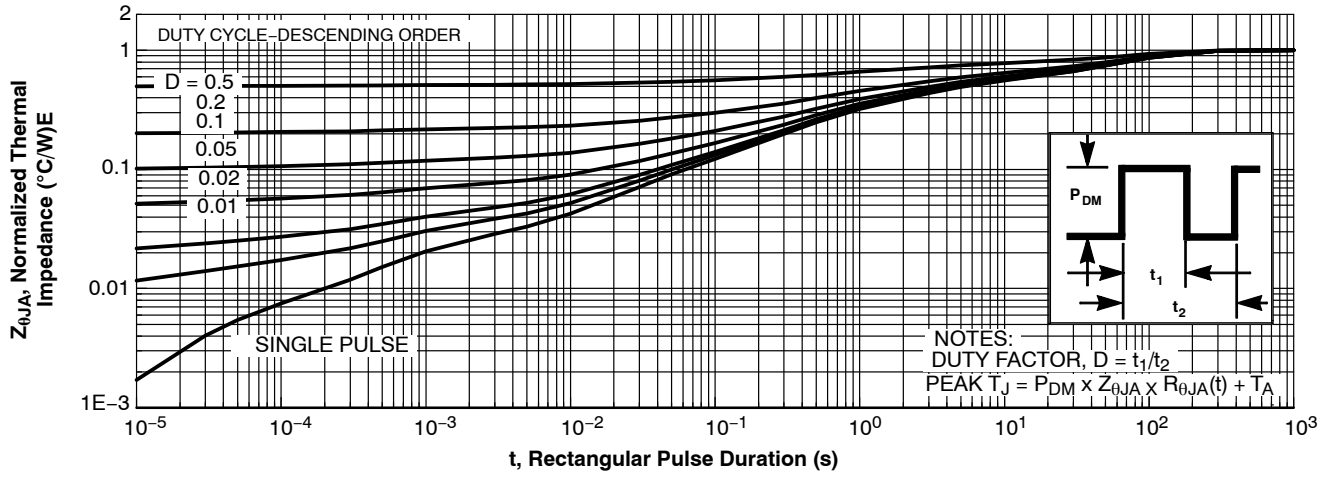
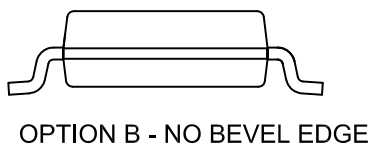
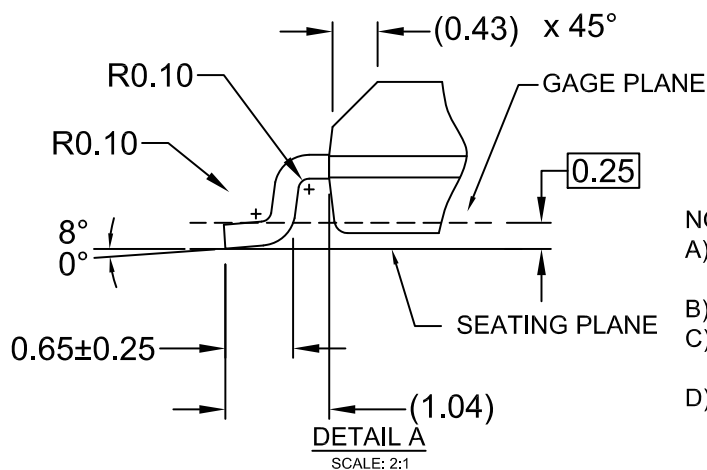
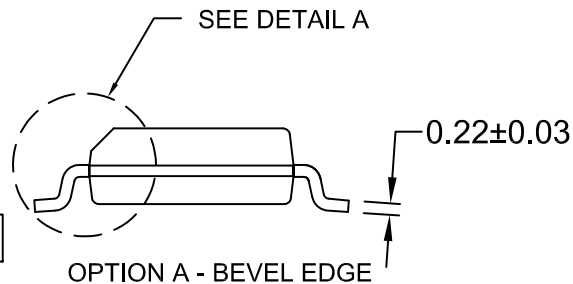
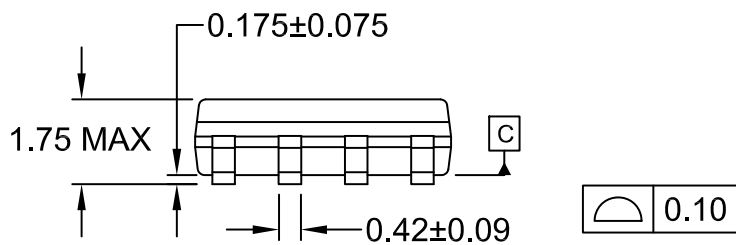
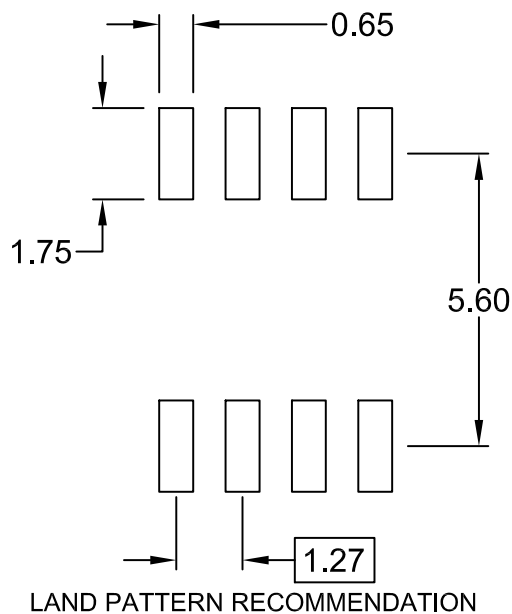
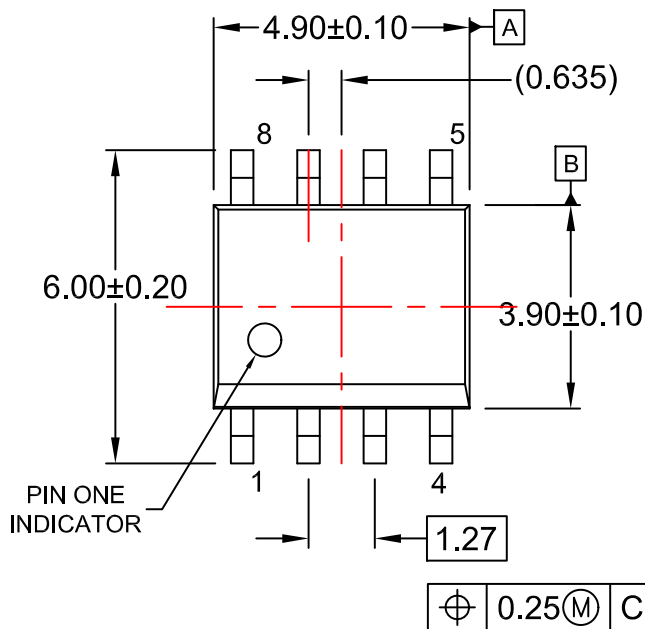

Figure 13. Transient Thermal Response Curve

SOIC8  
CASE 751EB  
ISSUE A

DATE 24 AUG 2017



- NOTES:  
 A) THIS PACKAGE CONFORMS TO JEDEC MS-012, VARIATION AA.  
 B) ALL DIMENSIONS ARE IN MILLIMETERS.  
 C) DIMENSIONS DO NOT INCLUDE MOLD FLASH OR BURRS.  
 D) LANDPATTERN STANDARD: SOIC127P600X175-8M

DOCUMENT NUMBER:	98AON13735G	Electronic versions are uncontrolled except when accessed directly from the Document Repository. Printed versions are uncontrolled except when stamped "CONTROLLED COPY" in red.
DESCRIPTION:	SOIC8	PAGE 1 OF 1

onsemi and ONSEMI are trademarks of Semiconductor Components Industries, LLC dba onsemi or its subsidiaries in the United States and/or other countries. onsemi reserves the right to make changes without further notice to any products herein. onsemi makes no warranty, representation or guarantee regarding the suitability of its products for any particular purpose, nor does onsemi assume any liability arising out of the application or use of any product or circuit, and specifically disclaims any and all liability, including without limitation special, consequential or incidental damages. onsemi does not convey any license under its patent rights nor the rights of others.

**onsemi**, **Onsemi**, and other names, marks, and brands are registered and/or common law trademarks of Semiconductor Components Industries, LLC dba "**onsemi**" or its affiliates and/or subsidiaries in the United States and/or other countries. **onsemi** owns the rights to a number of patents, trademarks, copyrights, trade secrets, and other intellectual property. A listing of **onsemi**'s product/patent coverage may be accessed at [www.onsemi.com/site/pdf/Patent-Marking.pdf](http://www.onsemi.com/site/pdf/Patent-Marking.pdf). **onsemi** reserves the right to make changes at any time to any products or information herein, without notice. The information herein is provided "as-is" and **onsemi** makes no warranty, representation or guarantee regarding the accuracy of the information, product features, availability, functionality, or suitability of its products for any particular purpose, nor does **onsemi** assume any liability arising out of the application or use of any product or circuit, and specifically disclaims any and all liability, including without limitation special, consequential or incidental damages. Buyer is responsible for its products and applications using **onsemi** products, including compliance with all laws, regulations and safety requirements or standards, regardless of any support or applications information provided by **onsemi**. "Typical" parameters which may be provided in **onsemi** data sheets and/or specifications can and do vary in different applications and actual performance may vary over time. All operating parameters, including "Typicals" must be validated for each customer application by customer's technical experts. **onsemi** does not convey any license under any of its intellectual property rights nor the rights of others. **onsemi** products are not designed, intended, or authorized for use as a critical component in life support systems or any FDA Class 3 medical devices or medical devices with a same or similar classification in a foreign jurisdiction or any devices intended for implantation in the human body. Should Buyer purchase or use **onsemi** products for any such unintended or unauthorized application, Buyer shall indemnify and hold **onsemi** and its officers, employees, subsidiaries, affiliates, and distributors harmless against all claims, costs, damages, and expenses, and reasonable attorney fees arising out of, directly or indirectly, any claim of personal injury or death associated with such unintended or unauthorized use, even if such claim alleges that **onsemi** was negligent regarding the design or manufacture of the part. **onsemi** is an Equal Opportunity/Affirmative Action Employer. This literature is subject to all applicable copyright laws and is not for resale in any manner.

## ADDITIONAL INFORMATION

### TECHNICAL PUBLICATIONS:

Technical Library: [www.onsemi.com/design/resources/technical-documentation](http://www.onsemi.com/design/resources/technical-documentation)  
onsemi Website: [www.onsemi.com](http://www.onsemi.com)

### ONLINE SUPPORT: [www.onsemi.com/support](http://www.onsemi.com/support)

For additional information, please contact your local Sales Representative at [www.onsemi.com/support/sales](http://www.onsemi.com/support/sales)