

MOSFET – N-Channel, UNIFET™

250 V, 51 A, 60 mΩ

FDP51N25, FDPF51N25

Description

UniFET MOSFET is onsemi's high voltage MOSFET family based on planar stripe and DMOS technology. This MOSFET is tailored to reduce on-state resistance, and to provide better switching performance and higher avalanche energy strength. This device family is suitable for switching power converter applications such as power factor correction (PFC), flat panel display (FPD) TV power, ATX and electronic lamp ballasts.

Features

- $R_{DS(on)} = 48 \text{ m}\Omega$ (Typ.) @ $V_{GS} = 10 \text{ V}$, $I_D = 25.5 \text{ A}$
- Low Gate Charge (Typ. 55 nC)
- Low C_{rss} (Typ. 63 pF)

Applications

- PDP TV
- Lighting
- Uninterruptible Power Supply
- AC-DC Power Supply

V_{DSS}	$R_{DS(on)}$ MAX	I_D MAX
250 V	60 mΩ @ 10 V	51 A

MARKING DIAGRAM

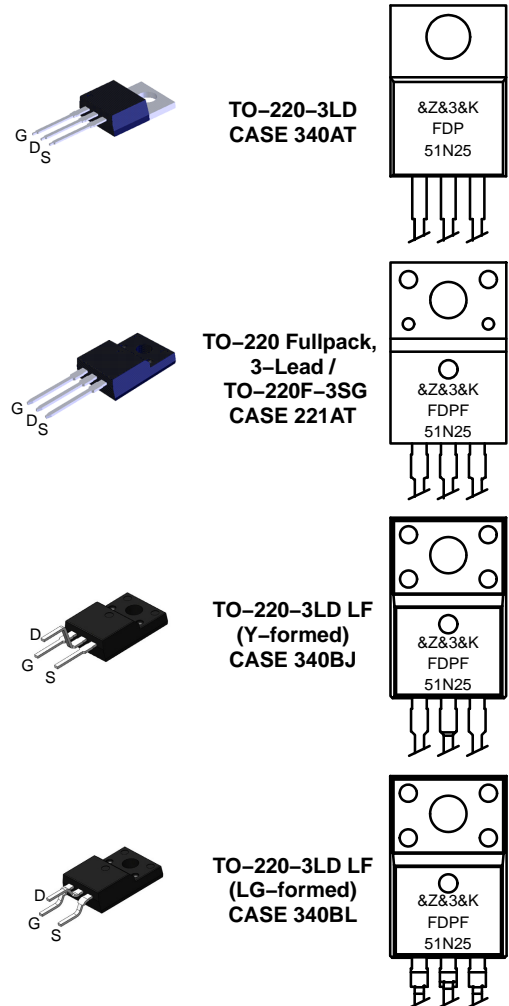

&Z = Assembly Plant Code
 &3 = 3-Digit Date Code
 &K = 2-Digits Lot Run Code
 FDP51N25, FDPF51N25 = Specific Device Code

N-CHANNEL MOSFET

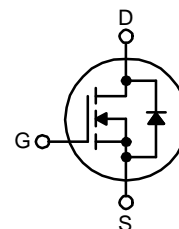

ORDERING INFORMATION

See detailed ordering and shipping information on page 9 of this data sheet.

FDP51N25, FDPF51N25

ABSOLUTE MAXIMUM RATINGS (T_C = 25°C unless otherwise noted)

Symbol	Parameter		FDPF51N25		Unit
			FDP51N25	FDPF51N25YDTU FDPF51N25RDTU	
V _{DSS}	Drain–Source Voltage		250		V
I _D	Drain Current	– Continuous (T _C = 25°C)	51	51*	A
		– Continuous (T _C = 100°C)	30	30*	A
I _{DM}	Drain Current	– Pulsed (Note 1)	204	204*	A
V _{GSS}	Gate–Source Voltage		±30		V
E _{AS}	Single Pulsed Avalanche Energy (Note 2)		1111		mJ
I _{AR}	Avalanche Current (Note 1)		51		A
E _{AR}	Repetitive Avalanche Energy (Note 1)		32		mJ
V _{ISO}	Insulation Withstand Voltage (RMS) from All Three Leads to External Heat Sink (t = 0.3 s; T _C = 25°C)		N/A	2500	V
dv/dt	Peak Diode Recovery dv/dt (Note 3)		4.5		V/ns
P _D	Power Dissipation	(T _C = 25°C)	320	38	W
		– Derate Above 25°C	3.7	0.3	W/°C
T _J , T _{STG}	Operating and Storage Temperature Range		–55 to +150		°C
T _L	Maximum Lead Temperature for Soldering, 1/8" from Case for 5 Seconds		300		°C

Stresses exceeding those listed in the Maximum Ratings table may damage the device. If any of these limits are exceeded, device functionality should not be assumed, damage may occur and reliability may be affected.

*Drain current limited by maximum junction temperature.

1. Repetitive rating: pulse–width limited by maximum junction temperature.

2. L = 0.68 mH, I_{AS} = 51 A, V_{DD} = 50 V, R_G = 25 Ω, starting T_J = 25°C.

3. I_{SD} ≤ 51 A, di/dt ≤ 200 A/μs, V_{DD} ≤ BV_{DSS}, starting T_J = 25°C.

THERMAL CHARACTERISTICS

Symbol	Parameter		FDPF51N25		Unit
			FDP51N25	FDPF51N25YDTU FDPF51N25RDTU	
R _{θJC}	Thermal Resistance, Junction–to–Case, Max.		0.39	3.3	°C/W
R _{θJA}	Thermal Resistance, Junction–to–Ambient, Max.		62.5	62.5	°C/W

FDP51N25, FDPF51N25

ELECTRICAL CHARACTERISTICS (T_C = 25°C unless otherwise noted)

Symbol	Parameter	Conditions	Min	Typ	Max	Unit
--------	-----------	------------	-----	-----	-----	------

OFF CHARACTERISTICS

BV _{DSS}	Drain–Source Breakdown Voltage	V _{GS} = 0 V, I _D = 250 μA, T _J = 25°C	250	–	–	V
ΔBV _{DSS} / ΔT _J	Breakdown Voltage Temperature Coefficient	I _D = 250 μA, Referenced to 25°C	–	0.25	–	V/°C
I _{DSS}	Zero Gate Voltage Drain Current	V _{DS} = 250 V, V _{GS} = 0 V V _{DS} = 200 V, T _C = 125°C	–	–	1 10	μA μA
I _{GSSF}	Gate–Body Leakage Current, Forward	V _{GS} = 30 V, V _{DS} = 0 V	–	–	100	nA
I _{GSSR}	Gate–Body Leakage Current, Reverse	V _{GS} = –30 V, V _{DS} = 0V	–	–	–100	nA

ON CHARACTERISTICS

V _{GS(th)}	Gate Threshold Voltage	V _{DS} = V _{GS} , I _D = 250 μA	3.0	–	5.0	V
R _{DS(on)}	Static Drain–Source On–Resistance	V _{GS} = 10 V, I _D = 25.5 A	–	0.048	0.060	Ω
g _{FS}	Forward Transconductance	V _{DS} = 40 V, I _D = 25.5 A	–	43	–	S

DYNAMIC CHARACTERISTICS

C _{iss}	Input Capacitance	V _{DS} = 25 V, V _{GS} = 0 V, f = 1 MHz	–	2620	3410	pF
C _{oss}	Output Capacitance		–	530	690	pF
C _{rss}	Reverse Transfer Capacitance		–	63	90	pF

SWITCHING CHARACTERISTICS

t _{d(on)}	Turn–On Delay Time	V _{DD} = 125 V, I _D = 51 A, V _{GS} = 10 V, R _G = 25 Ω (Note 4)	–	62	135	ns
t _r	Turn–On Rise Time		–	465	940	ns
t _{d(off)}	Turn–Off Delay Time		–	98	205	ns
t _f	Turn–Off Fall Time		–	130	270	ns
Q _g	Total Gate Charge	V _{DS} = 200 V, I _D = 51 A, V _{GS} = 10 V (Note 4)	–	55	70	nC
Q _{gs}	Gate–Source Charge		–	16	–	nC
Q _{gd}	Gate–Drain Charge		–	27	–	nC

DRAIN–SOURCE DIODE CHARACTERISTICS AND MAXIMUM RATINGS

I _S	Maximum Continuous Drain–Source Diode Forward Current	–	–	51	A	
I _{SM}	Maximum Pulsed Drain–Source Diode Forward Current	–	–	204	A	
V _{SD}	Drain–Source Diode Forward Voltage	V _{GS} = 0 V, I _S = 51 A	–	–	1.4	V
t _{rr}	Reverse Recovery Time	V _{GS} = 0 V, I _S = 51 A, di/dt = 100 A/μs	–	178	–	ns
Q _{rr}	Reverse Recovery Charge		–	4.0	–	μC

Product parametric performance is indicated in the Electrical Characteristics for the listed test conditions, unless otherwise noted. Product performance may not be indicated by the Electrical Characteristics if operated under different conditions.

4. Essentially independent of operating temperature typical characteristics.

FDP51N25, FDPF51N25

TYPICAL PERFORMANCE CHARACTERISTICS

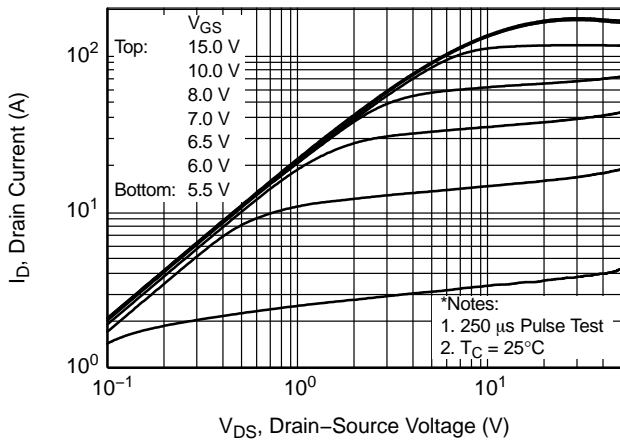

Figure 1. On-Region Characteristics

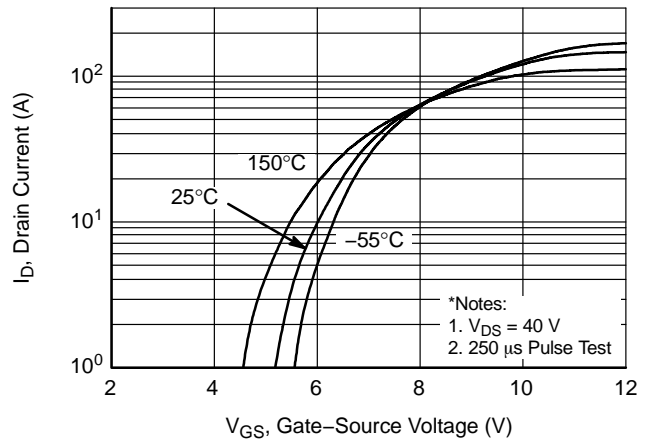

Figure 2. Transfer Characteristics

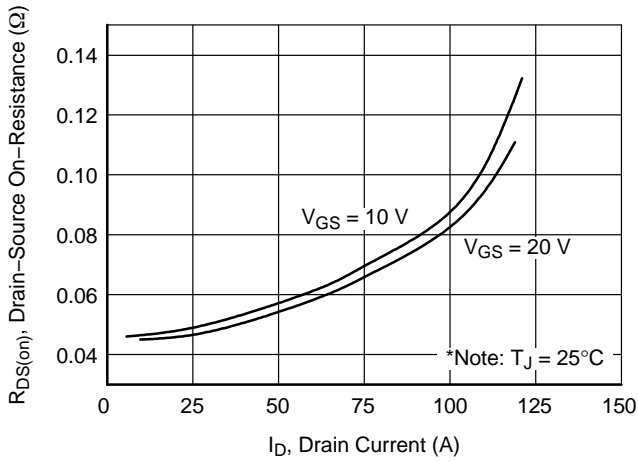

Figure 3. On-Resistance Variation vs. Drain Current and Gate Voltage

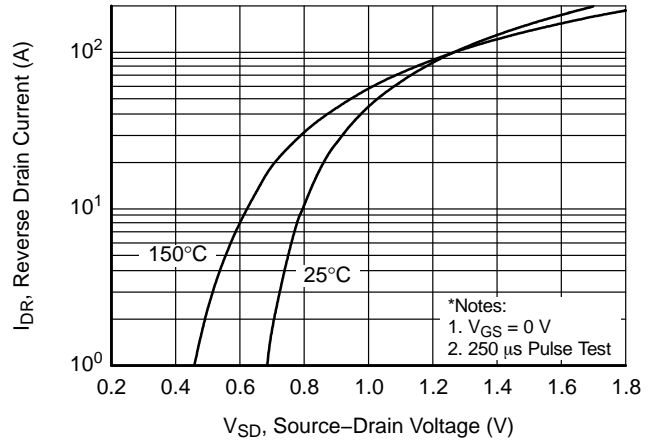

Figure 4. Body Diode Forward Voltage Variation vs. Source Current and Temperature

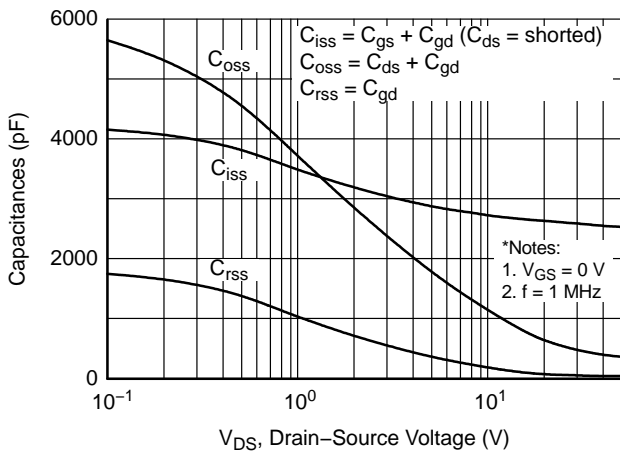

Figure 5. Capacitance Characteristics

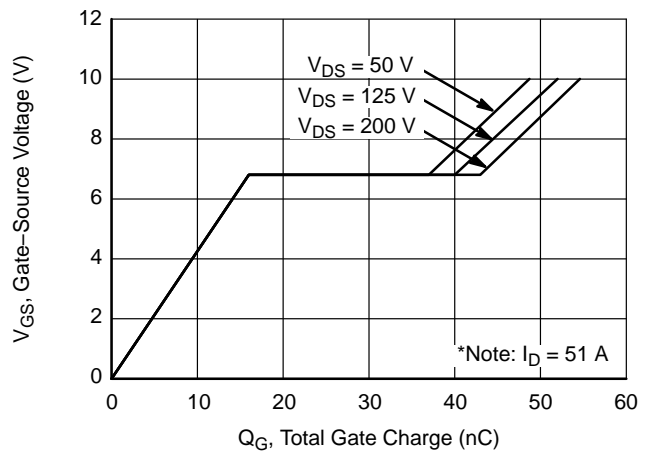

Figure 6. Gate Charge Characteristics

FDP51N25, FDPF51N25

TYPICAL PERFORMANCE CHARACTERISTICS (CONTINUED)

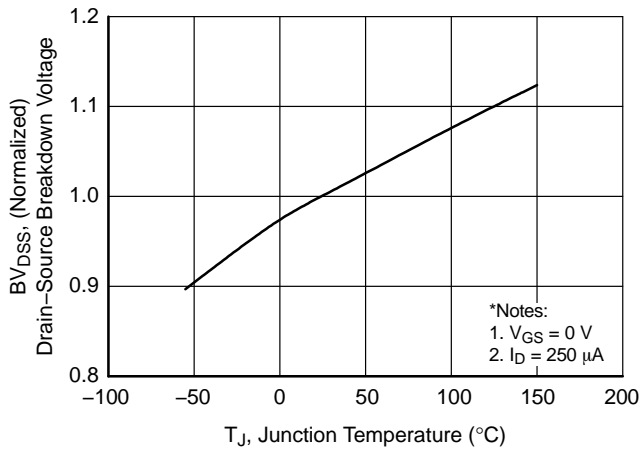

Figure 7. Breakdown Voltage Variation vs. Temperature

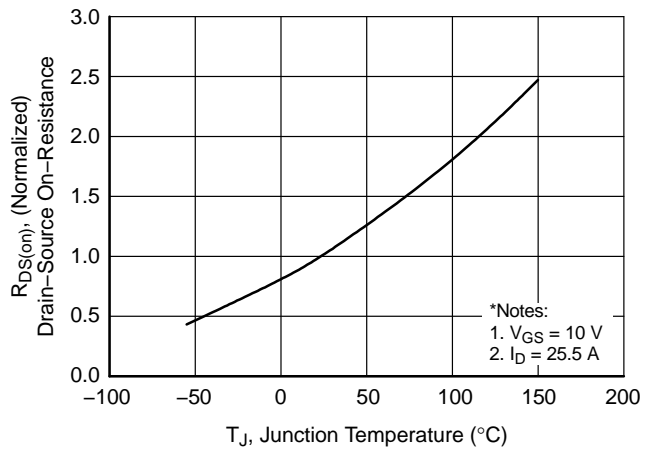

Figure 8. On-Resistance Variation vs. Temperature

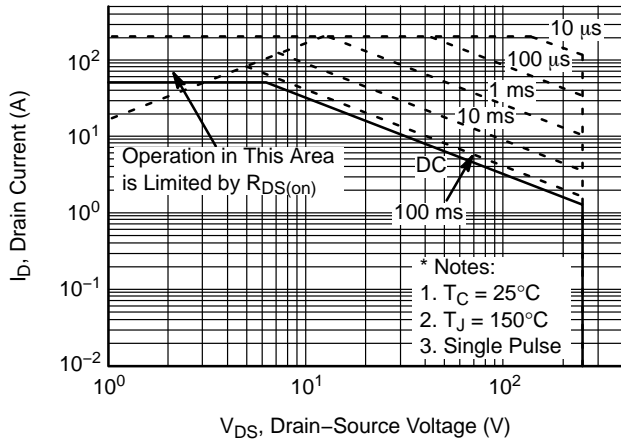

Figure 9-1. Maximum Safe Operating Area for FDP51N25

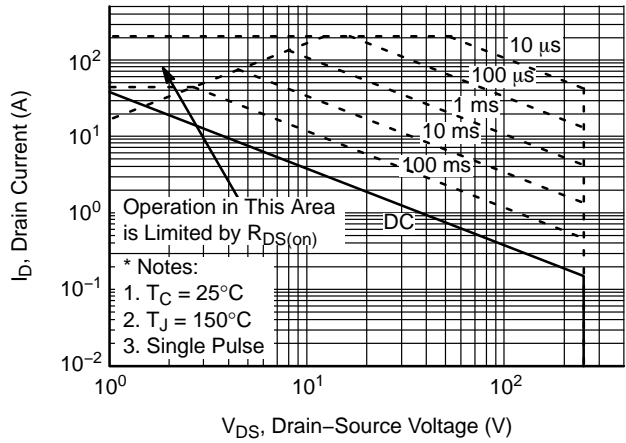

Figure 9-2. Maximum Safe Operating Area for FDPF51N25 / FDPF51N25YDTU

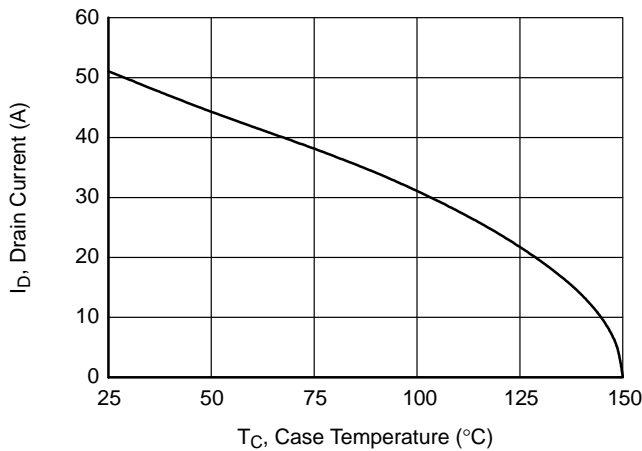

Figure 10. Maximum Drain Current vs. Case Temperature

FDP51N25, FDPF51N25

TYPICAL PERFORMANCE CHARACTERISTICS (CONTINUED)

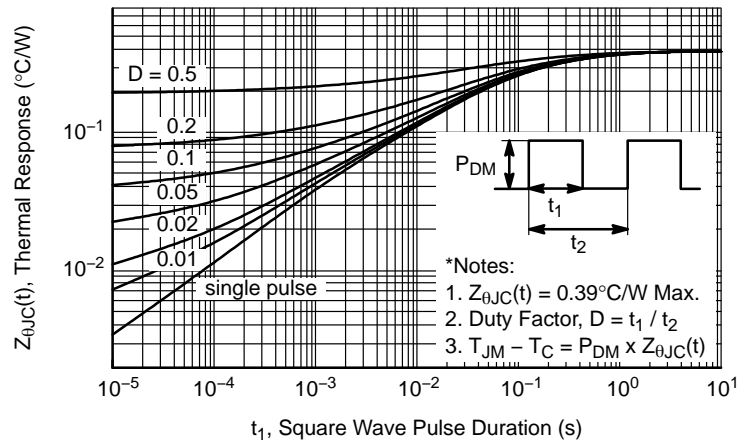

Figure 11-1. Transient Thermal Response Curve for FDP51N25

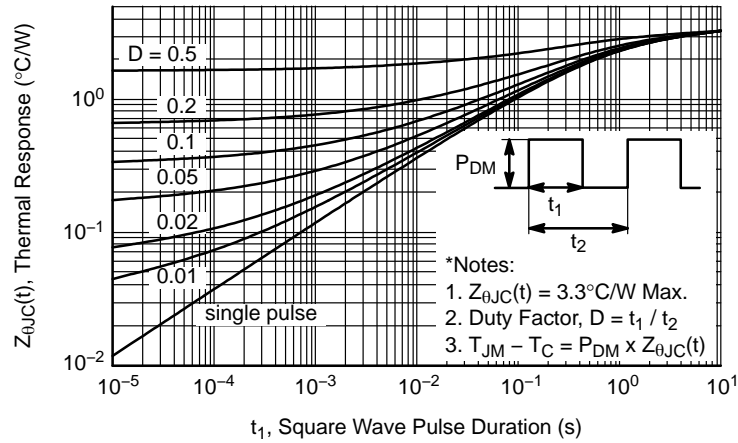

Figure 11-2. Transient Thermal Response Curve for FDPF51N25 / FDPF51N25YDTU

FDP51N25, FDPF51N25

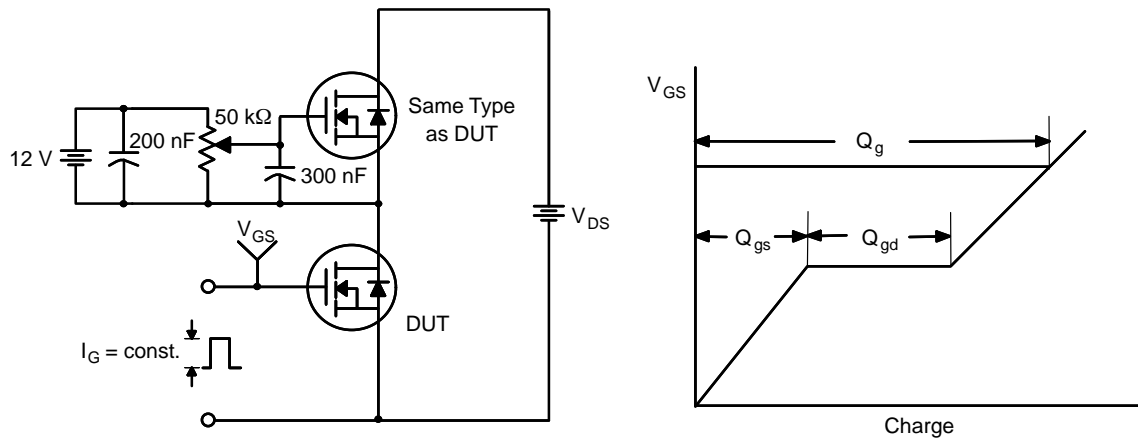

Figure 11. Gate Charge Test Circuit & Waveform

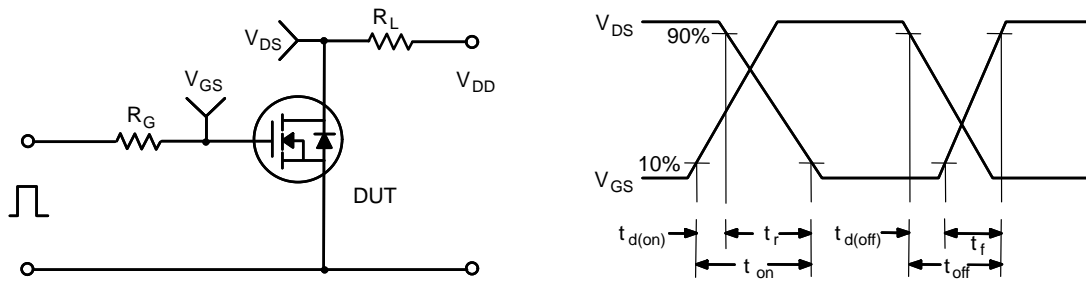

Figure 12. Resistive Switching Test Circuit & Waveforms

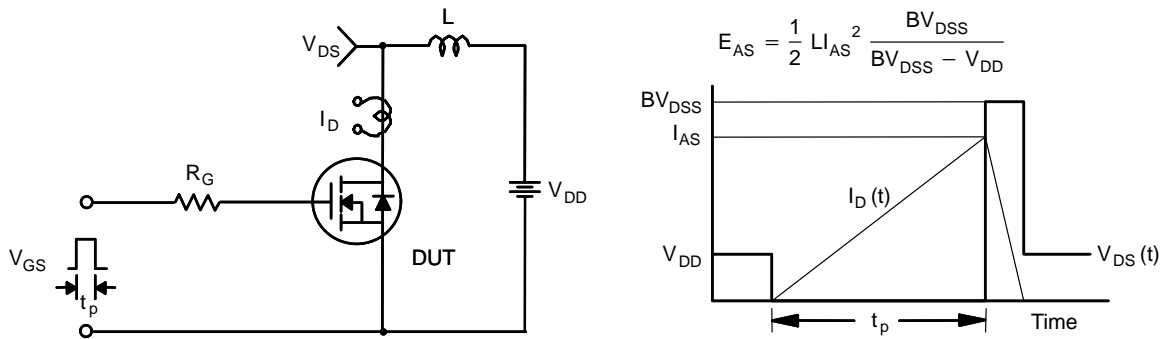
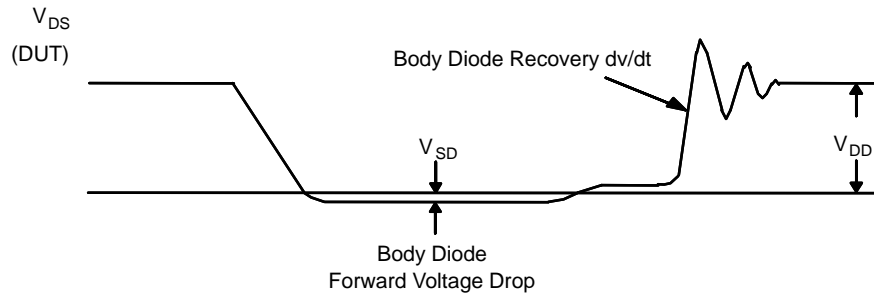
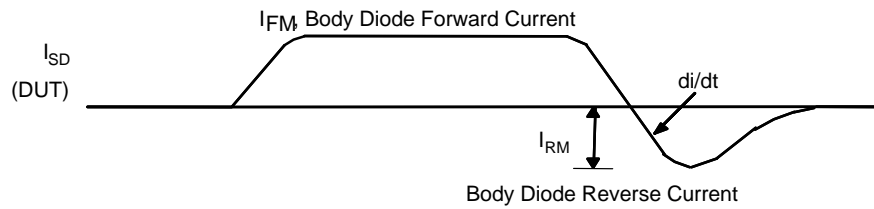
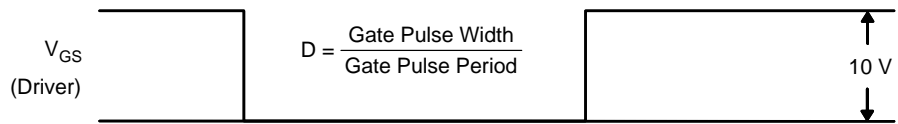
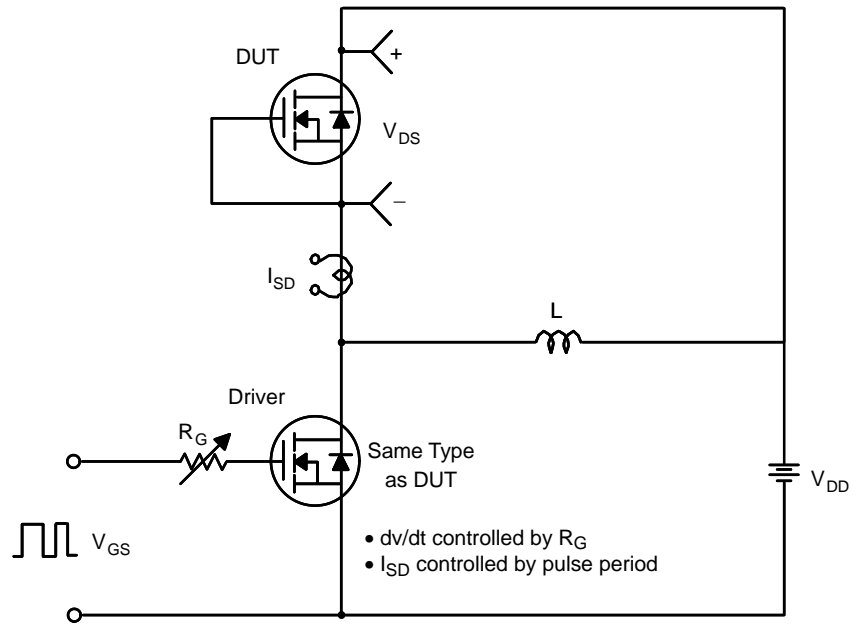

Figure 13. Unclamped Inductive Switching Test Circuit & Waveforms

FDP51N25, FDPF51N25



FDP51N25, FDPF51N25

PACKAGE MARKING AND ORDERING INFORMATION

Part Number	Top Mark	Package	Shipping
FDP51N25	FDP51N25	TO-220-3LD CASE 340AT	50 Units / Tube
FDPF51N25	FDPF51N25	TO-220 Fullpack, 3-Lead / TO-220F-3SG CASE 221AT	50 Units / Tube
FDPF51N25YDTU	FDPF51N25	TO-220-3LD LF (Y-formed) CASE 340BJ	50 Units / Tube
FDPF51N25RDTU	FDPF51N25	TO-220-3LD LF (LG-formed) CASE 340BL	50 Units / Tube

UniFET is trademark of Semiconductor Components Industries, LLC dba "onsemi" or its affiliates and/or subsidiaries in the United States and/or other countries.

MECHANICAL CASE OUTLINE

PACKAGE DIMENSIONS

ON Semiconductor®



TO-220 Fullpack, 3-Lead / TO-220F-3SG CASE 221AT ISSUE B

DATE 19 JAN 2021

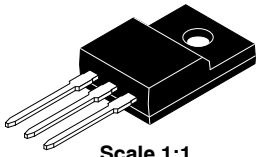

Scale 1:1

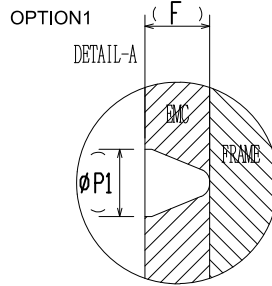
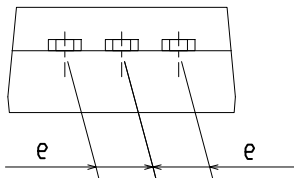
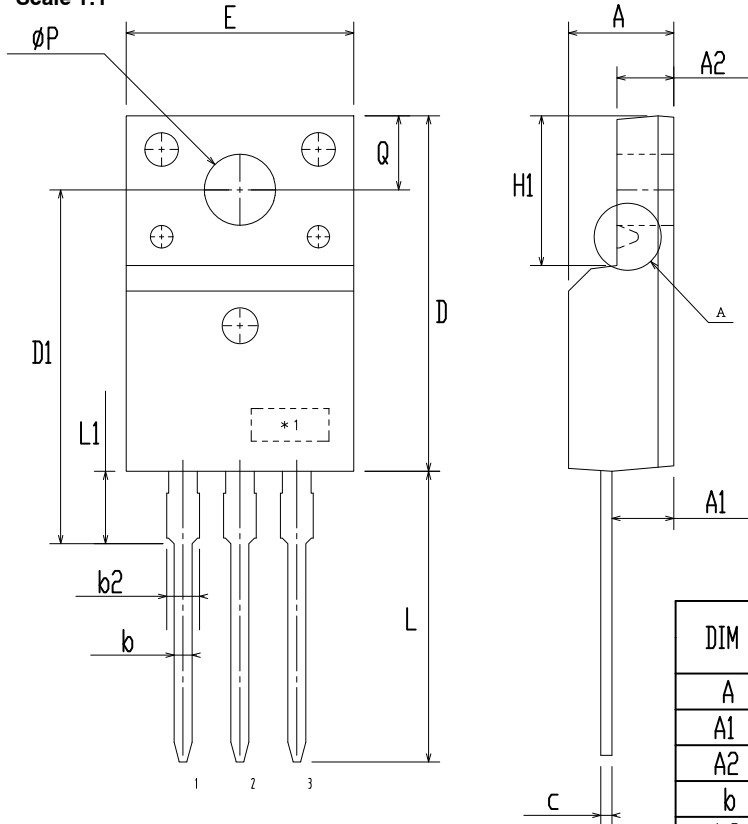

DIM	MILLIMETERS		
	MIN	NOM	MAX
A	4.50	4.70	4.90
A1	2.56	2.76	2.96
A2	2.34	2.54	2.74
b	0.70	0.80	0.90
b2	~	~	1.47
c	0.45	0.50	0.60
D	15.67	15.87	16.07
D1	15.60	15.80	16.00
E	9.96	10.16	10.36
e	2.34	2.54	2.74
F	~	0.84	~
H1	6.48	6.68	6.88
L	12.78	12.98	13.18
L1	3.03	3.23	3.43
phi P	2.98	3.18	3.38
phi P1	~	1.00	~
Q	3.20	3.30	3.40

NOTES:

- A. DIMENSION AND TOLERANCE AS ASME Y14.5-2009
- B. DIMENSIONS ARE EXCLUSIVE OF BURRS, MOLD FLASH AND TIE BAR PROTRUCTIONS.
- C. OPTION 1 - WITH SUPPORT PIN HOLE
OPTION 2 - NO SUPPORT PIN HOLE

DOCUMENT NUMBER:	98AON67439E	Electronic versions are uncontrolled except when accessed directly from the Document Repository. Printed versions are uncontrolled except when stamped "CONTROLLED COPY" in red.
DESCRIPTION:	TO-220 FULLPACK, 3-LEAD / TO-220F-3SG	PAGE 1 OF 1

ON Semiconductor and are trademarks of Semiconductor Components Industries, LLC dba ON Semiconductor or its subsidiaries in the United States and/or other countries. ON Semiconductor reserves the right to make changes without further notice to any products herein. ON Semiconductor makes no warranty, representation or guarantee regarding the suitability of its products for any particular purpose, nor does ON Semiconductor assume any liability arising out of the application or use of any product or circuit, and specifically disclaims any and all liability, including without limitation special, consequential or incidental damages. ON Semiconductor does not convey any license under its patent rights nor the rights of others.

MECHANICAL CASE OUTLINE

PACKAGE DIMENSIONS

ON Semiconductor®

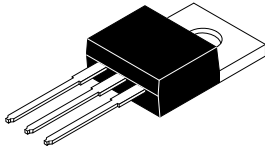

Scale 1:1

TO-220-3LD CASE 340AT ISSUE A

DATE 03 OCT 2017

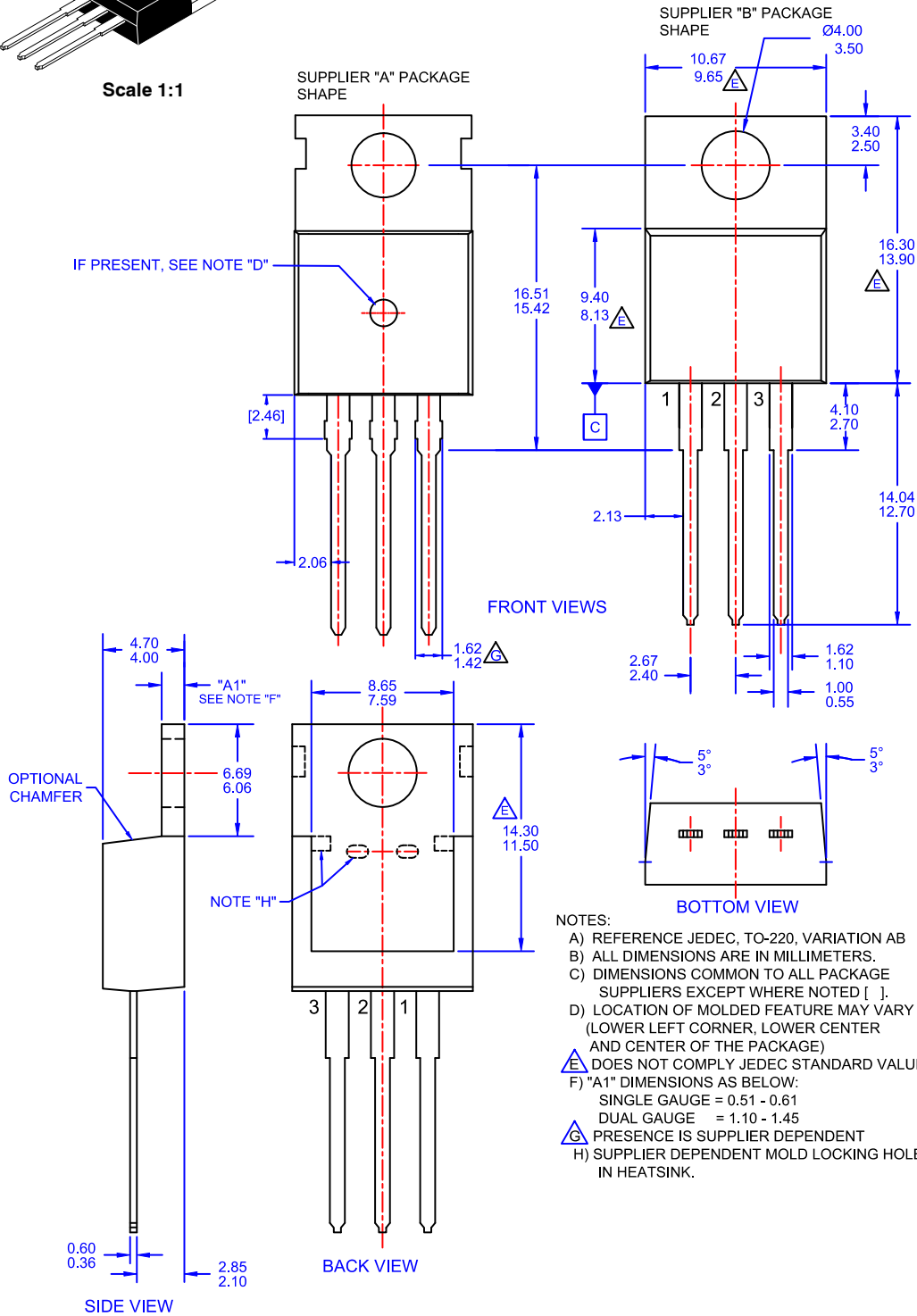

- NOTES:
- A) REFERENCE JEDEC, TO-220, VARIATION AB
 - B) ALL DIMENSIONS ARE IN MILLIMETERS.
 - C) DIMENSIONS COMMON TO ALL PACKAGE SUPPLIERS EXCEPT WHERE NOTED [].
 - D) LOCATION OF MOLDED FEATURE MAY VARY (LOWER LEFT CORNER, LOWER CENTER AND CENTER OF THE PACKAGE)
 - E) DOES NOT COMPLY JEDEC STANDARD VALUE.
 - F) "A1" DIMENSIONS AS BELOW:
 SINGLE GAUGE = 0.51 - 0.61
 DUAL GAUGE = 1.10 - 1.45
 - G) PRESENCE IS SUPPLIER DEPENDENT
 - H) SUPPLIER DEPENDENT MOLD LOCKING HOLES IN HEATSINK.

DOCUMENT NUMBER:	98AON13818G	Electronic versions are uncontrolled except when accessed directly from the Document Repository. Printed versions are uncontrolled except when stamped "CONTROLLED COPY" in red.
DESCRIPTION:	TO-220-3LD	PAGE 1 OF 1

ON Semiconductor and ON are trademarks of Semiconductor Components Industries, LLC dba ON Semiconductor or its subsidiaries in the United States and/or other countries. ON Semiconductor reserves the right to make changes without further notice to any products herein. ON Semiconductor makes no warranty, representation or guarantee regarding the suitability of its products for any particular purpose, nor does ON Semiconductor assume any liability arising out of the application or use of any product or circuit, and specifically disclaims any and all liability, including without limitation special, consequential or incidental damages. ON Semiconductor does not convey any license under its patent rights nor the rights of others.

MECHANICAL CASE OUTLINE
PACKAGE DIMENSIONS

ON Semiconductor®



TO-220-3LD LF
CASE 340BJ
ISSUE O

DATE 31 AUG 2016

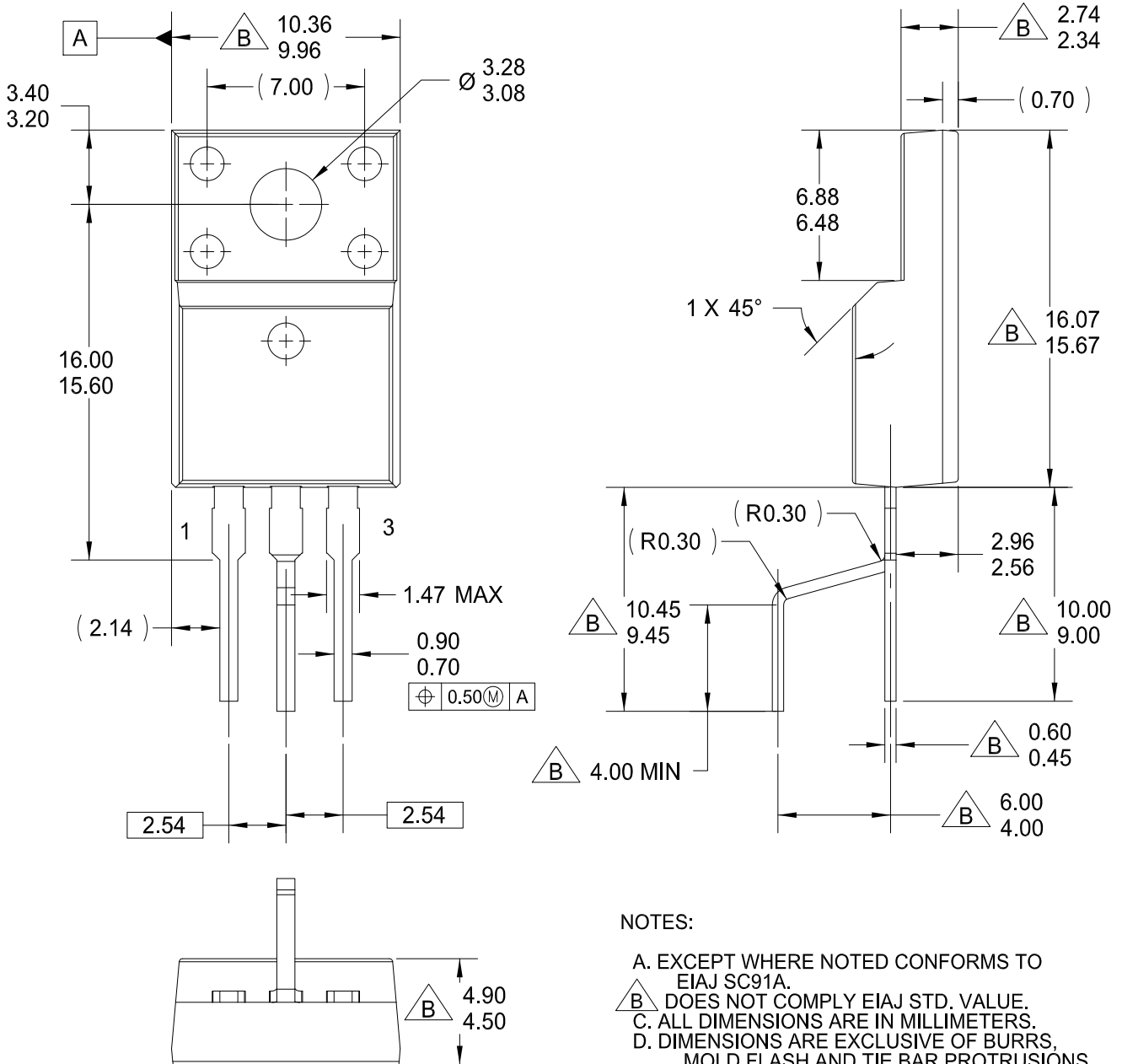

NOTES:

- A. EXCEPT WHERE NOTED CONFORMS TO EIAJ SC91A.
- B.** DOES NOT COMPLY EIAJ STD. VALUE.
- C. ALL DIMENSIONS ARE IN MILLIMETERS.
- D. DIMENSIONS ARE EXCLUSIVE OF BURRS, MOLD FLASH AND TIE BAR PROTRUSIONS.
- E. DIMENSION AND TOLERANCE AS PER ASME Y14.5-1994.

DOCUMENT NUMBER:	98AON13842G	Electronic versions are uncontrolled except when accessed directly from the Document Repository. Printed versions are uncontrolled except when stamped "CONTROLLED COPY" in red.
DESCRIPTION:	TO-220-3LD LF	PAGE 1 OF 1

ON Semiconductor and are trademarks of Semiconductor Components Industries, LLC dba ON Semiconductor or its subsidiaries in the United States and/or other countries. ON Semiconductor reserves the right to make changes without further notice to any products herein. ON Semiconductor makes no warranty, representation or guarantee regarding the suitability of its products for any particular purpose, nor does ON Semiconductor assume any liability arising out of the application or use of any product or circuit, and specifically disclaims any and all liability, including without limitation special, consequential or incidental damages. ON Semiconductor does not convey any license under its patent rights nor the rights of others.

MECHANICAL CASE OUTLINE
PACKAGE DIMENSIONS

ON Semiconductor®



TO-220-3LD LF
CASE 340BL
ISSUE O

DATE 31 AUG 2016

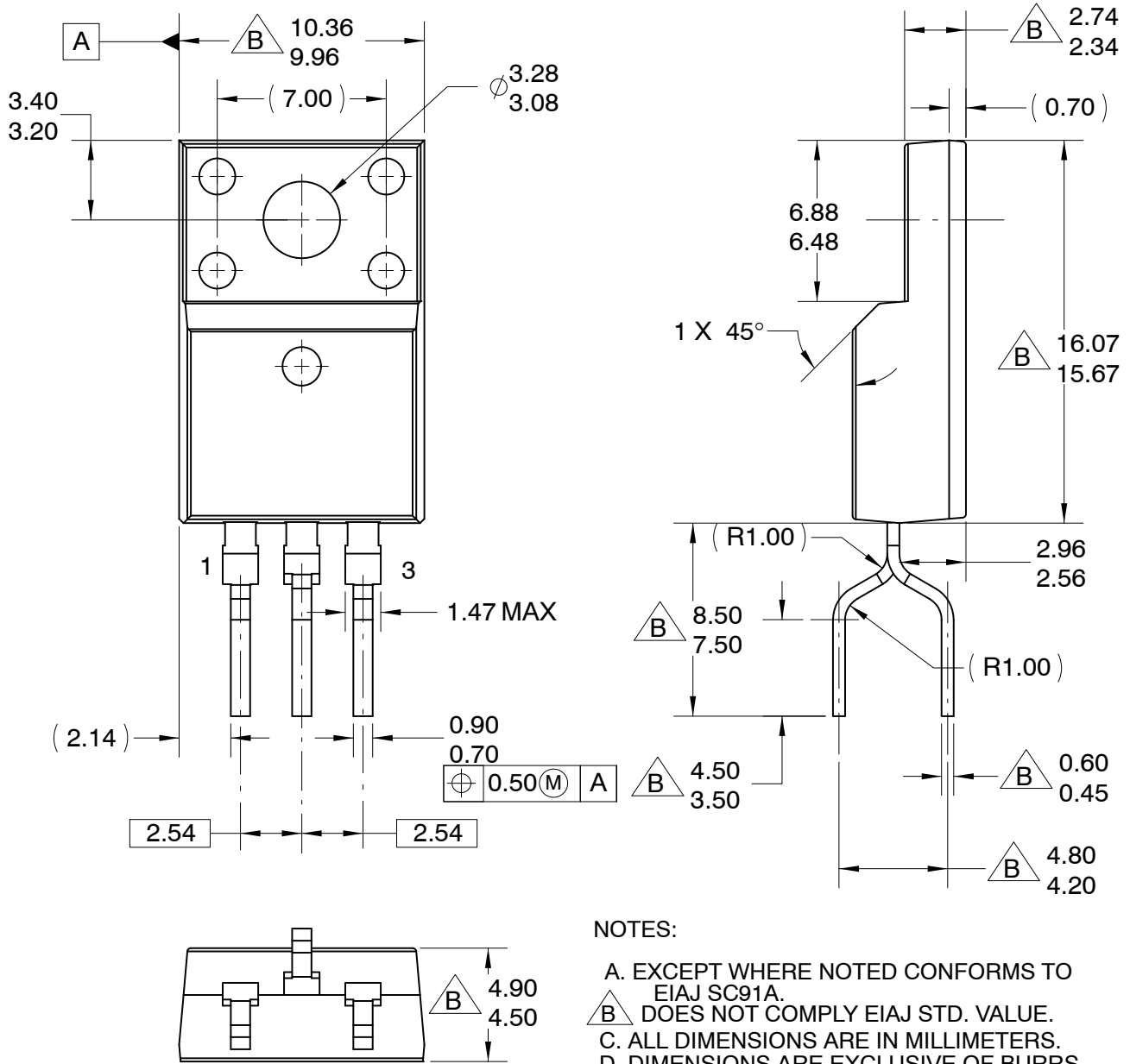

NOTES:

- A. EXCEPT WHERE NOTED CONFORMS TO EIAJ SC91A.
- B. DOES NOT COMPLY EIAJ STD. VALUE.
- C. ALL DIMENSIONS ARE IN MILLIMETERS.
- D. DIMENSIONS ARE EXCLUSIVE OF BURRS, MOLD FLASH AND TIE BAR PROTRUSIONS.
- E. DIMENSION AND TOLERANCE AS PER ASME Y14.5-1994.

DOCUMENT NUMBER:	98AON13844G	Electronic versions are uncontrolled except when accessed directly from the Document Repository. Printed versions are uncontrolled except when stamped "CONTROLLED COPY" in red.
DESCRIPTION:	TO-220-3LD LF	PAGE 1 OF 1

ON Semiconductor and are trademarks of Semiconductor Components Industries, LLC dba ON Semiconductor or its subsidiaries in the United States and/or other countries. ON Semiconductor reserves the right to make changes without further notice to any products herein. ON Semiconductor makes no warranty, representation or guarantee regarding the suitability of its products for any particular purpose, nor does ON Semiconductor assume any liability arising out of the application or use of any product or circuit, and specifically disclaims any and all liability, including without limitation special, consequential or incidental damages. ON Semiconductor does not convey any license under its patent rights nor the rights of others.

onsemi, **Onsemi**, and other names, marks, and brands are registered and/or common law trademarks of Semiconductor Components Industries, LLC dba "**onsemi**" or its affiliates and/or subsidiaries in the United States and/or other countries. **onsemi** owns the rights to a number of patents, trademarks, copyrights, trade secrets, and other intellectual property. A listing of **onsemi**'s product/patent coverage may be accessed at www.onsemi.com/site/pdf/Patent-Marking.pdf. **onsemi** reserves the right to make changes at any time to any products or information herein, without notice. The information herein is provided "as-is" and **onsemi** makes no warranty, representation or guarantee regarding the accuracy of the information, product features, availability, functionality, or suitability of its products for any particular purpose, nor does **onsemi** assume any liability arising out of the application or use of any product or circuit, and specifically disclaims any and all liability, including without limitation special, consequential or incidental damages. Buyer is responsible for its products and applications using **onsemi** products, including compliance with all laws, regulations and safety requirements or standards, regardless of any support or applications information provided by **onsemi**. "Typical" parameters which may be provided in **onsemi** data sheets and/or specifications can and do vary in different applications and actual performance may vary over time. All operating parameters, including "Typicals" must be validated for each customer application by customer's technical experts. **onsemi** does not convey any license under any of its intellectual property rights nor the rights of others. **onsemi** products are not designed, intended, or authorized for use as a critical component in life support systems or any FDA Class 3 medical devices or medical devices with a same or similar classification in a foreign jurisdiction or any devices intended for implantation in the human body. Should Buyer purchase or use **onsemi** products for any such unintended or unauthorized application, Buyer shall indemnify and hold **onsemi** and its officers, employees, subsidiaries, affiliates, and distributors harmless against all claims, costs, damages, and expenses, and reasonable attorney fees arising out of, directly or indirectly, any claim of personal injury or death associated with such unintended or unauthorized use, even if such claim alleges that **onsemi** was negligent regarding the design or manufacture of the part. **onsemi** is an Equal Opportunity/Affirmative Action Employer. This literature is subject to all applicable copyright laws and is not for resale in any manner.

ADDITIONAL INFORMATION

TECHNICAL PUBLICATIONS:

Technical Library: www.onsemi.com/design/resources/technical-documentation
onsemi Website: www.onsemi.com

ONLINE SUPPORT: www.onsemi.com/support

For additional information, please contact your local Sales Representative at www.onsemi.com/support/sales