

500 mA USB Compatible Single Cell Li-Lon Linear Charger with “Power Back” Capability



ON Semiconductor®

www.onsemi.com

FAN54120

The FAN54120 is a small, low-cost, fully integrated single-cell charger which supports dead battery revival, pre-charge, fast charge, and float charge states.

Fast charging current (I_{FAST}) is set with an external resistor. Pre-charge (I_{PRE}) and charge complete (I_{CHGEND}) currents are factory set at $I_{FAST}/5.2$ and $I_{FAST}/10$, respectively.

The FAN54120 is specifically designed for ease-of-use as a stand-alone charger. It requires no user interaction or active supervision.

An open-drain \overline{STAT} pin provides charge and/or fault status indication.

“Power Back” capability to source accessories from the battery.

The FAN54120 is available in a 2x2 DFN package or a 1.36x0.76 mm WLCSP.

Features

- Fully Integrated Charger for Single Cell Li-Ion or Li-Polymer Batteries
- Factory Configured Charge Voltage (Ordering Option)
- $\pm 0.5\%$ Charge Voltage Accuracy
- User Determined Fast Charge Current Via External Resistor
- $\pm 4\%$ Charge Current Accuracy
- 28 V Maximum Input Voltage, 6 V Operating
- Ultra-low Battery Discharge Current (<120 nA)
- True Reverse Current Blocking
- Adaptive Thermal Regulation
- Supports JEITA Safe-to-Charge Operation with an External NTC
- “Power Back Functionality to Power Accessories from the Battery

Application

- IoT Devices
- E-Cigs / Vapes
- Personal Mobile Devices (Games, Camera, etc.)
- Toys
- Point-of-Sale Instruments



DFN6 2x2, 0.65P
CASE 506DQ

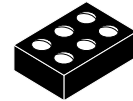

WLCSP6 1.36x0.76
CASE 567XQ

MARKING DIAGRAM

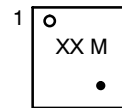

XX = 20, Specific Device Number
M = One Digit Date Code
● = Pb Free

ORDERING INFORMATION

See detailed ordering and shipping information on page 2 of this data sheet.

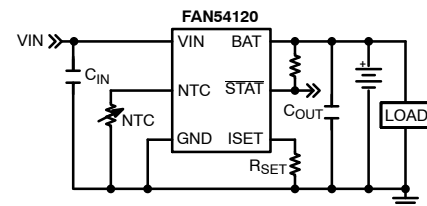

Figure 1. Typical Application

FAN54120

Table 1. ORDERING INFORMATION

Part Number	V _{FLOAT} (V)	Package	Packing Method [†]
FAN54120MP420X	4.20	DFN6, 2x2 mm (Pb Free)	3000 / Tape & Reel
FAN54120MP425X	4.25		
FAN54120MP435X	4.35		
FAN54120UC420X	4.20	WLCSP-6, 1.36x0.76 mm (Pb Free)	3000 / Tape & Reel
FAN54120UC425X	4.25		
FAN54120UC435X	4.35		

[†]For information on tape and reel specifications, including part orientation and tape sizes, please refer to our Tape and Reel Packaging Specifications Brochure, BRD8011/D.

BLOCK DIAGRAM

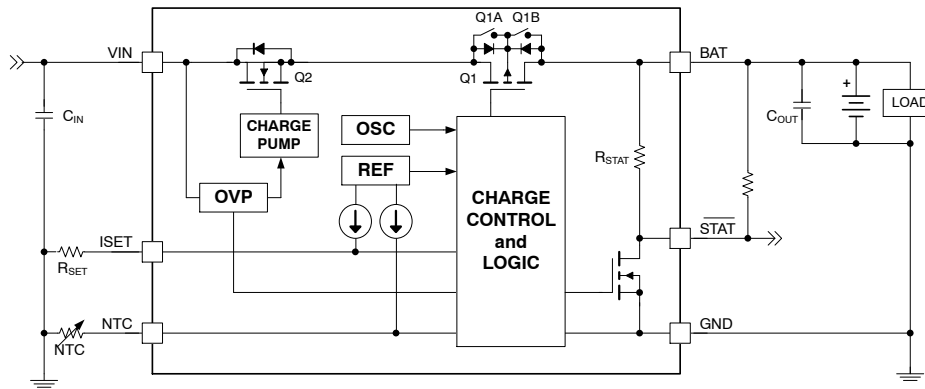

Figure 2. Simplified Block Diagram

Table 2. RECOMMENDED EXTERNAL COMPONENTS

Component	Description	Supplier	Parametr	Unit	Typ.
C _{IN}	1.0 μF, 25 V, 10%, X5R, 0603	Murata GRM188R61E105KAAD	C	μF	1.0 (Note 2)
C _{OUT} (Note 1)	1.0 μF, 10 V, 10%, X5R, 0402	Murata GRM155R61A105KE15	C	μF	1.0 (Note 2)
NTC	10 KΩ, 1%, B _{25/85} = 3380, 0402	Murata NCP15XH103F03RC	R ₂₅	KΩ	10

1. The minimum required C_{OUT} value is shown. The expected bypass capacitance range is 1 μF to 10 μF. For applications with large dynamic pulsed loads, additional C_{OUT} may be necessary to constraint voltage deviations.
2. The typical (face) value does not include the effects of applied voltage or temperature de-rating.

FAN54120

PIN CONNECTIONS

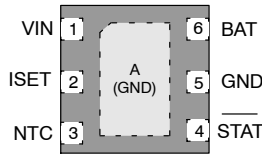

Top View

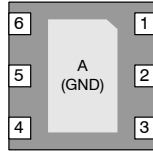

Bottom View

Figure 3. DFN Package

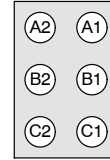
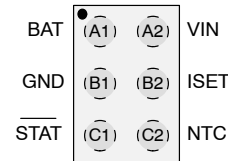

Figure 4. WLCSP Package

Table 3. PIN DEFINITIONS

DFN Pin	WLCSP Pin	Pin Name	Description
1	A2	VIN	Input Voltage. Connect C_{IN} bypass directly to VIN and GND pins on top layer.
2	B2	ISET	Set Charge Current. Connect R_{SET} directly to GND to set the maximum input/charging current (I_{FAST}).
3	C2	NTC	NTC input. Connect to battery pack NTC to provide JEITA "safe-charging" functionality. See "NTC Pin" applications section for additional usage information.
4	C1	STAT	Status. Open-drain output used to indicate charge and/or fault status. Internally, there is a weak pull-up (R_{STAT}) to BAT. This pin is also used to enable Power Back operation.
5, A	B1	GND	Ground. Connect to system GND plane. C_{IN} and C_{OUT} also connect directly to this pin on top layer.
6	A1	BAT	Output. Connect to system load and positive terminal of battery. Bypass with C_{OUT} , connected directly to BAT and GND pins on top layer.

Table 4. ABSOLUTE MAXIMUM RATINGS

Symbol	Parameter	Min.	Max.	Unit
V_{IN}	Voltage on VIN Pin	-1.2	28.0	V
V_{IN_SLEW}	VIN Rise Time, $V_{IN} > 6$ V		10	V/ μ sec
V_{BAT}	Voltage on BAT Pin	-0.3	6.3	V
V_X	Voltage on All Other Pins	-0.3	(Note 3)	V
ESD	Electrostatic Discharge Protection Level, HBM per JESD22-A114		1500	V
	Electrostatic Discharge Protection Level, CDM per JESD22-C101		2000	V
LU	Latch Up per JESD78, Class I, 25°C		± 100	mA
T_J	Junction Temperature	-40	+150	°C
T_{STG}	Storage Temperature	-65	+150	°C
T_{LS}	Lead Soldering Temperature, 10 Seconds		+260	°C

Stresses exceeding those listed in the Maximum Ratings table may damage the device. If any of these limits are exceeded, device functionality should not be assumed, damage may occur and reliability may be affected.

3. Lesser of 6.3 V or the higher of $V_{IN} + 0.3$ V or $V_{BAT} + 0.3$ V.

FAN54120

Table 5. RECOMMENDED OPERATING CONDITIONS

Symbol	Parameter	Min.	Max.	Unit
V _{IN}	Voltage on VIN Pin	4	6	V
V _{BAT}	Battery Voltage	2.5	4.5	V
T _A	Ambient Temperature	-30	+85	°C
T _J	Junction Temperature	-30	+120	°C

Functional operation above the stresses listed in the Recommended Operating Ranges is not implied. Extended exposure to stresses beyond the Recommended Operating Ranges limits may affect device reliability.

NOTE: The Recommended Operating Conditions table defines the conditions for actual device operation using the circuit of Figure 1, with the Recommended External Components shown in Table 2. Recommended operating conditions are specified to ensure optimal performance to the datasheet specifications. On Semiconductor does not recommend exceeding them or designing to the Absolute Maximum Ratings.

Table 6. THERMAL PROPERTIES

Symbol	Parameter		Typical	Unit
θ _{JA}	Thermal Resistance, Junction to Ambient	DFN-6	75	°C/W
		CSP-6	140	
θ _{JB}	Thermal Resistance, Junction to Board (Note 4)	DFN-6	50	°C/W
		CSP-6	70	

NOTE: Thermal resistance is a function of application and board layout. This data is measured with four-layer 2s2p boards in accordance with JEDEC standard JESD51. Special attention must be paid to not exceed junction temperature T_{J(max)} at a given ambient temperature T_A.

4. θ_{JB} measured using On Semiconductor evaluation board.

Table 7. ELECTRICAL CHARACTERISTICS (Unless otherwise specified, circuit of Figure 1 with V_{IN} = 5.0 V, V_{FLOAT} = 4.2 V, V_{BAT} = 3.9 V, R_{SET} = 1.0 kΩ, over recommended T_A operating temperature range. Typical values are at 25°C.)

SYMBOL	PARAMETER	CONDITION	MIN.	TYP.	MAX.	UNIT
POWER SOURCES						
V _{IN(RISE)}	V _{IN} Rising UVLO Threshold	V _{BAT} ≤ 3.9 V	4.25	4.40	4.55	V
V _{IN(FALL)}	V _{IN} Falling UVLO Threshold	V _{BAT} ≤ 2.9 V	3.00	3.15	3.30	V
V _{SLP_R}	Sleep Comparator Threshold	V _{IN} - V _{BAT} Rising		80		mV
V _{SLP_F}		V _{IN} - V _{BAT} Falling		30		mV
t _{IN_VALID}	VIN Validation Time (Note 7)	V _{IN} > V _{IN(RISE)}		32		msec
R _{IN_VALID}	VIN Validation Load			100		Ω
V _{VAL_HYST}	VIN Validation Hysteresis	V _{IN} Drop, from V _{IN(RISE)} , During Validation		200		mV
I _{IN_Q}	VIN Quiescent Current	5.0 V _{IN} , I _{BAT} = 0, NTC = GND, R _{SET} = 10 kΩ		600	720	μA
V _{DROP}	Drop-Out Voltage (V _{IN} - V _{BAT})	V _{IN} = 4.75 V, R _{SET} = 1 kΩ		280	450	mV
I _{BAT_LKG}	Battery Discharge Current, Sleep Mode	V _{BAT} = 4.2 V, VIN Open		120	300	nA
I _{VIN_LKG}	BAT-to-VIN Leakage Current	V _{BAT} = 4.2 V, V _{IN} = 0 V			300	nA
V _{IN_OVP}	VIN Over-Voltage Protection Threshold	Rising V _{IN}	6.0	6.3	6.6	V
CHARGER VOLTAGE REGULATION						
V _{FLOAT}	Float Voltage Range, V _{BAT}	Fixed Factory Set-point, 50 mV Increments	4.20		4.35	V
	Float Voltage Accuracy, V _{BAT} (Note 7)	0 ≤ T _J ≤ +50°C	-0.5		0.5	%
		-10 ≤ T _J ≤ +85°C	-1.2		+1.0	%
		-30 ≤ T _J ≤ +120°C	-1.5		+1.0	%
V _{BATMIN}	Pre-to-Fast Charge Threshold	Rising V _{BAT}	2.9	3.1	3.3	V
V _{RCH}	Battery Recharge Indicator Threshold	V _{BAT} Falling Below V _{FLOAT} - V _{RCH}		120		mV
V _{SHORT}	Battery Short Circuit Threshold	Rising V _{BAT}	2.1	2.2	2.3	V

FAN54120

Table 7. ELECTRICAL CHARACTERISTICS (Unless otherwise specified, circuit of Figure 1 with $V_{IN} = 5.0\text{ V}$, $V_{FLOAT} = 4.2\text{ V}$, $V_{BAT} = 3.9\text{ V}$, $R_{SET} = 1.0\text{ k}\Omega$, over recommended T_A operating temperature range. Typical values are at 25°C .) (continued)

SYMBOL	PARAMETER	CONDITION	MIN.	TYP.	MAX.	UNIT
CHARGER VOLTAGE REGULATION						
V_{SC_HYST}	Battery Short Circuit Hysteresis	Falling V_{BAT}		100		mV
CHARGER CURRENT REGULATION						
I_{FAST}	Fast Charge Current Range	$10\text{ k}\Omega \geq R_{SET} \geq 1.0\text{ k}\Omega$	50		500	mA
	Fast Charge Current Accuracy (Note 5)	$R_{SET} = 1.0\text{ k}\Omega$	460	480	500	mA
		$R_{SET} = 2.5\text{ k}\Omega$	180	192	205	mA
		$R_{SET} = 10\text{ k}\Omega$	40	48	56	mA
I_{PRE}	Pre-Charge Current	$V_{SHORT} < V_{BAT} < V_{BATMIN}$		$I_{FAST} / 5.2$		mA
	Pre-Charge Current Accuracy (Note 5) (Note 6)	$R_{SET} = 1.0\text{ k}\Omega$	-6		+6	%
		$R_{SET} = 2.5\text{ k}\Omega$	-8		+8	%
		$R_{SET} = 10\text{ k}\Omega$	-10		+10	%
I_{CHGEND}	Charge Complete Current			$I_{FAST} / 10$		mA
	Charge Complete Current (Note 5) (Note 6)	$R_{SET} = 1.0\text{ k}\Omega$	-8		+8	%
		$R_{SET} = 2.5\text{ k}\Omega$	-10		+10	%
		$R_{SET} = 10\text{ k}\Omega$	-15		+15	%
t_{CHGENE}	Charge Complete Qualification Time (Note 7)	Operating in V_{FLOAT} Mode		32		msec
R_{SET_SC}	Minimum R_{SET} Value	$R_{SET} \leq R_{SET_SC}$ Results in Output Fault State			900	Ω
T_{RSET_SC}	Shorted R_{SET} Qualification Time (Note 7)			1		msec
STAT PIN						
$I_{STAT(HI)}$	\overline{STAT} Pin Leakage	$V_{\overline{STAT}} = 4.5\text{ V}$			100	nA
$V_{STAT(LO)}$	\overline{STAT} Sink Capability	$I_{\overline{STAT}} = 5\text{ mA}$			0.4	V
R_{STAT}	\overline{STAT} Internal Pull-Up			1		M Ω
NTC PIN						
I_{NTC}	Source Current	V_{IN} Valid, $100\text{ mV} < V_{NTC} < 2.0\text{ V}$	48	50	52	μA
		NTC = GND		Off		
T_{0C}	Cold Non-Charging Threshold	Rising V_{NTC} , Charging Ceases	1225	1255	1285	mV
T_{45C}	Warm Charging Threshold	Falling V_{NTC} , Charge Reduction (T_{JEITA} , I_{JEITA})	255	270	280	mV
T_{60C}	Hot Non-Charging Threshold	Falling V_{NTC} , Charging Ceases	160	170	180	mV
t_{NTC}	NTC pin Sampling Interval (Note 7)	$100\text{ mV} < V_{NTC} < 2.0\text{ V}$		1		sec
T_{JEITA}	V_{FLOAT} Reduction	$T_{45C} \geq V_{NTC} \geq T_{60C}$		200		mV
I_{JEITA}	I_{FAST} Reduction	$T_{45C} \geq V_{NTC} \geq T_{60C}$		20		%
THERMAL PROTECTION						
T_{REG}	Thermal Regulation Threshold (Note 7) (Note 8)	T_J Rising	109	120	130	$^\circ\text{C}$
T_{REG_HYST}	Thermal Regulation Hysteresis (Note 7)	T_J Falling		20		$^\circ\text{C}$
I_{TREG}	Adaptive Thermal Regulation Foldback (Note 7)		40		80	% I_{FAST}
T_{SDOWN}	Thermal Shutdown Threshold (Note 7) (Note 8)	T_J Rising	130	145	160	$^\circ\text{C}$
	Hysteresis (Note 7)	T_J Falling		T_{REG}		$^\circ\text{C}$
t_{TSD_QUAL}	Thermal Shutdown Qualification Time (Note 7)	T_J Rising		1		msec
t_{DIE_T}	Die Temperature Sampling Rate (Note 7)			32		msec

FAN54120

Table 7. ELECTRICAL CHARACTERISTICS (Unless otherwise specified, circuit of Figure 1 with $V_{IN} = 5.0\text{ V}$, $V_{FLOAT} = 4.2\text{ V}$, $V_{BAT} = 3.9\text{ V}$, $R_{SET} = 1.0\text{ k}\Omega$, over recommended T_A operating temperature range. Typical values are at 25°C .) (continued)

SYMBOL	PARAMETER	CONDITION	MIN.	TYP.	MAX.	UNIT
TIMERS						
t_{PRE_SC}	Pre-Charge Fault Timer (Note 7)			32		msec
t_{OSC}	Internal Oscillator Accuracy	Applies to All Timers/Counters	-15		+15	%
t_{IN_REVAL}	Input Re-Validation Attempt Period (Note 7)			2		sec
POWER BACK						
$V_{STAT_IN(HI)}$	\overline{STAT} Pin Input Logic HIGH Threshold	No V_{IN} Applied, $V_{BAT} > V_{BATMIN}$	1.2			V
$V_{STAT_IN(LO)}$	\overline{STAT} Pin Input Logic LOW Threshold	No V_{IN} Applied, $V_{BAT} > V_{BATMIN}$			0.4	V
$V_{PBAK(UVLO)}$	Power Back UVLO Threshold	Not Start if $V_{BAT} < V_{BATMIN}$		V_{BATMIN}		V
$t_{PBACK(ST)}$	Power Back Start Delay (Note 7)	Falling \overline{STAT} until V_{IN} Rise Commences		2.7		msec
$I_{PBACK(ST)}$	Power Back Start-Up Inrush (Note 7)	$3.9 V_{BAT}$, No V_{IN} Load		180		mA
I_{Q_PBACK}	Power Back Quiescent Current			100	150	μA

Product parametric performance is indicated in the Electrical Characteristics for the listed test conditions, unless otherwise noted. Product performance may not be indicated by the Electrical Characteristics if operated under different conditions.

5. Current accuracies are specified with minimum 50 mV overhead ($V_{IN} - V_{BAT}$)
6. Specified accuracy relative to actual/nominal I_{FAST} level.
7. Performance guaranteed over the indicated operating temperature range by design and/or characterization. Not tested in production.
8. Power Back mode uses T_{REG} as thermal shutdown threshold.

TYPICAL CHARACTERISTIC

Unless otherwise specified, circuit of Figure 1 with $V_{IN} = 5.0\text{ V}$, $V_{FLOAT} = 4.2\text{ V}$, $V_{BAT} = 3.8\text{ V}$, $R_{SET} = 1.0\text{ k}\Omega$, $T_A = 25^\circ\text{C}$.

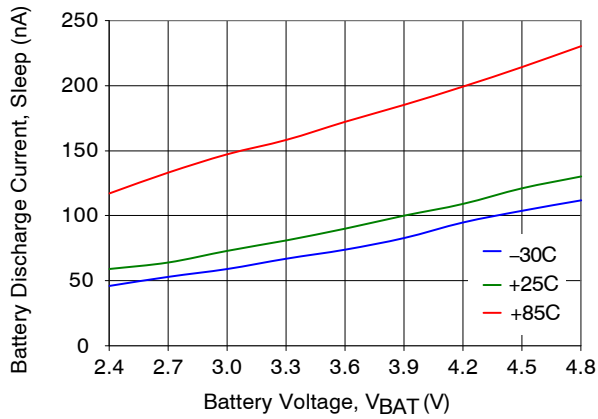

Figure 5. Sleep Mode Discharge Current

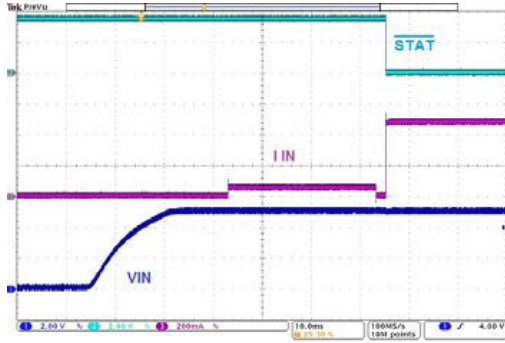

Figure 6. Start-Up V_{IN} Insertion, $V_{BAT} = 3.8\text{ V}$

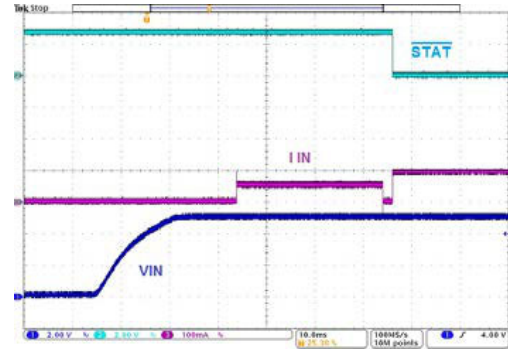

Figure 7. Start-Up at V_{IN} Insertion, $V_{BAT} = 2.9\text{ v}$

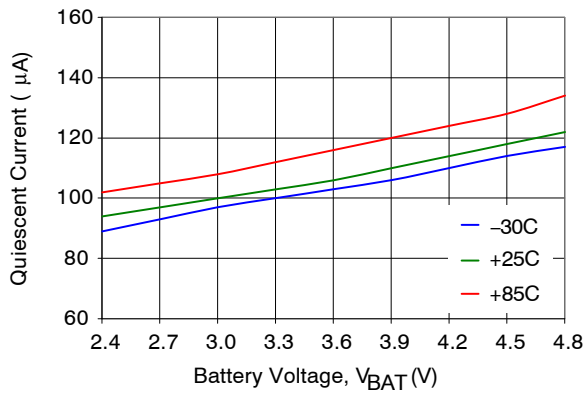

Figure 8. Power Back Mode Quiescent Current

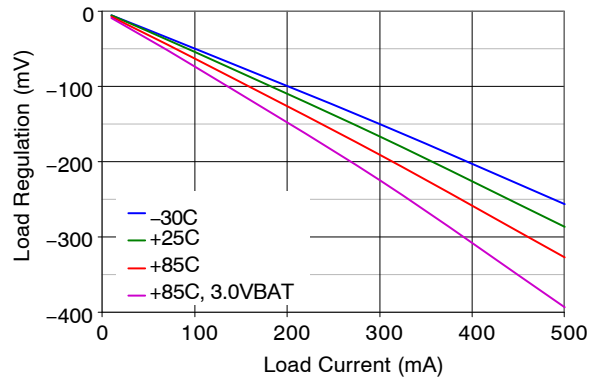

Figure 9. Power Back Mode Output Regulation

OPERATION / APPLICATION INFORMATION

ISET Pin – Setting the Charge Current (I_{FAST})

R_{SET} , connected to the ISET pin, is used to establish the maximum charging current (I_{FAST}). Input current will be slightly higher due to the quiescent current of the device flowing to GND.

$$I_{FAST}(mA) = 500 \div R_{SET}(k\Omega)$$

valid R_{SET} range: $1.0\text{ k}\Omega \leq R_{SET} \leq 10\text{ k}\Omega$

The accuracy/tolerance of the chosen R_{SET} will directly influence the tolerance/accuracy of I_{FAST} .

Selecting an R_{SET} value outside the specified range can result in a non-charging state.

An open ISET pin will set $I_{FAST} \sim 0$, resulting in battery discharge into the prevailing system load, even though the IC may attempt to regulate V_{FLOAT} .

Selecting $R_{SET} \leq R_{SET_SC}$ also results in a non-charging state. In this case, the IC will enter the Output Fault State, where it is latched off until the input power (V_{IN}) is recycled.

STAT Pin

In Charge mode, the \overline{STAT} pin, when asserted LOW, indicates that the battery is being actively charged. \overline{STAT} will remain HIGH during non-charging or fault states.

The \overline{STAT} pin asserts LOW when:

- Charging (I_{PRE} or I_{FAST})
- Thermal regulation
- Re-charge, battery drops below $V_{FLOAT} - V_{RCH}$ with a valid V_{IN} present
- $T_{45C} \leq V_{NTC} \leq T_{60C}$ (warm charging, JEITA reduction)

The \overline{STAT} pin is HIGH during:

- Absence of a validated V_{IN}
- Charge done ($I_{BAT} \leq I_{CHGEND}$)
- Thermal shutdown
- Input Over-Voltage (V_{IN_OVP}) state
- Output Fault state ($V_{BAT} \leq V_{SHORT}$)
- $V_{NTC} \geq T_{0C}$ (cold non-charging threshold)
- $V_{NTC} \leq T_{60C}$ (hot non-charging threshold)

The \overline{STAT} pin is also used to enable Power Back Mode (see Power Back Operation section).

NTC Pin – JEITA Functionality

The FAN54120 supports the JEITA Safe-to-Charge profile using the battery pack internal NTC device or a discrete NTC placed in close proximity to the battery.

The fixed threshold voltages are designed consistent with I_{NTC} sourcing a nominal NTC value of $10\text{ k}\Omega$, 1% and $B_{25/85} = 3380$. Other NTC devices can be used, although the corresponding threshold temperatures may shift.

At temperatures below the cold threshold ($< T_{0C}$) or above the hot threshold ($> T_{60C}$), charging is suspended and the pin tri-states.

At temperatures between the warm threshold ($> T_{45C}$) and hot threshold ($< T_{60C}$), V_{FLOAT} is internally reduced by V_{JEITA} and I_{FAST} is internally reduced by I_{JEITA} to prevent an unsafe charging condition. The \overline{STAT} pin remains asserted low.

For applications where the NTC device is undesired or not available, using a fixed $10\text{ k}\Omega$ R_{SET} will allow full charging without JEITA limitations. I_{NTC} remains on.

Similarly, connecting the NTC pin to GND will result in I_{NTC} being turned off and the JEITA thresholds disabled.

Leaving the NTC pin open/floating will result in a non-charging state.

It is the system designer's responsibility to ensure a safe charging environment, particularly when the JEITA feature is not utilized.

Input Power Connection and Validation

With no V_{IN} present (sleep state), Q2 and Q1 are off and the Q1A body switch is open.

Once V_{IN} rises above $V_{IN(RISE)}$, Q2 is gradually enhanced. Q1 remains off until Input Validation completes. If $V_{IN} \geq V_{IN_OVB}$ Q1 remains off until V_{IN} falls below V_{IN_OVHYS} and Input Validation occurs.

After Q2 is enhanced for $\sim 16\text{msec}$, Input Validation occurs. A load (R_{IN_VALID}) is applied to the input for t_{IN_VALID} . V_{IN} must remain above the V_{VAL_HYST} threshold for successful validation. If V_{IN} does not remain above V_{VAL_HYST} , R_{IN_VALID} is suspended and validation fails. If Input Validation fails, periodic validation attempts will be repeated at a rate of t_{IN_REVAL} while V_{IN} remains above the higher of $V_{IN(FALL)}$ or $V_{BAT} + V_{SLP}$.

CHARGING

Charging does not commence until the Input Validation, cycle completes. Q1 remains disabled and the \overline{STAT} pin is open-drain until charging starts.

Charging States

Figure 10 illustrates a common Li+ charging profile, starting with a depleted battery:

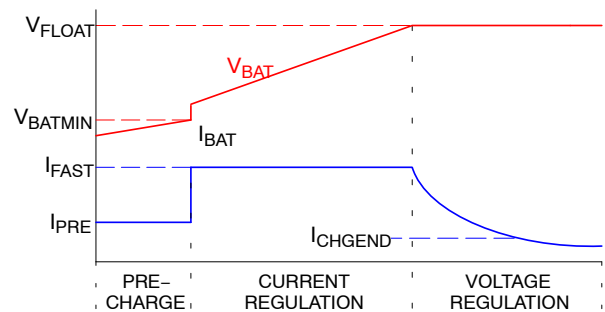

Figure 10. Typical Charging Profile

During the pre-conditioning stage (Pre-Charge), a constant current I_{PRE} ($I_{FAST}/5.2$) is applied until the battery voltage reaches V_{BATMIN} .

Once $V_{BAT} \geq V_{BATMIN}$, the fast charging current (I_{FAST}) is applied. I_{FAST} is set with a discrete resistor (R_{SET}) at the ISET pin. The instantaneous jump of V_{BAT} at V_{BATMIN} , is representative of the charging current increase across the series resistance of the battery path. The Current Regulation stage is maintained until V_{BAT} reaches V_{FLOAT} .

During the Voltage Regulation stage, charge current diminishes as the actual battery cell voltage approaches V_{FLOAT} . I_{BAT} is continuously monitored and, when it decreases to the charge complete (I_{CHGEND}) threshold ($I_{FAST}/10$), the battery is considered fully charged. Prior to entering the charge complete state, V_{FLOAT} control must be maintained, uninterrupted, for t_{CHGEND} . The IC continues V_{FLOAT} operation to support the load.

Once End-of-Charge is established, the \overline{STAT} pin tri-states until a new or re-charge cycle starts. A re-charge cycle is entered when $V_{BAT} \leq V_{FLOAT} - V_{RCH}$, where the \overline{STAT} pin re-asserts LOW until END-of-Charge is reached.

Output Fault State

This state is entered whenever $V_{BAT} \leq V_{SHORT}$ after charging commences or $R_{SET} \leq R_{SET_SC}$ during start-up to prevent potentially destructive currents in the device.

An Output Fault State will result in Q1, Q1A, and Q2 being latched off until input power (V_{IN}) is fully recycled.

Output Fault state is also entered at commencement of charging if I_{PRE} fails to charge $V_{BAT} > V_{SHORT}$ before the t_{PRE_SC} timer expires.

Input Disconnect/Detach

Upon removal of the input voltage source, as V_{IN} falls below the higher of $V_{IN(FALL)}$ or $V_{BAT} + V_{SLB}$, Q1 opens and R_{IN_VALID} is applied to discharge input caps. If V_{IN} remains below the $V_{IN(FALL)}$ level, sleep state is entered. Otherwise, periodic re-validation attempts occur.

Input Over-Voltage Protection

When rising V_{IN} reaches the input over-voltage threshold (V_{IN_OVP}), Q1 turns off, charging stops, and the \overline{STAT} pin becomes open drain. Automatic re-start occurs, with soft-start, once V_{IN} falls below V_{IN_OVHYS} and is re-validated.

Thermal Regulation

The FAN54120 autonomously reduces power dissipation upon reaching the thermal regulation temperature threshold ($T_J \geq T_{REG}$). It employs an adaptive scheme (I_{TREG}), which incrementally reduces charge current to nullify excessive temperature rise. It results in a higher average charging current being maintained than more traditional methods, for instance, reducing the charge current by half until the device cools.

While in the thermal regulation state, charge current is modulated to maintain device temperature between the T_{REG} and T_{REG_HYS} thresholds and \overline{STAT} remains asserted.

Thermal Shutdown

To prevent potentially catastrophic device failure, a 2nd level of thermal protection is provided. If T_J reaches the thermal shutdown threshold (T_{SDOWN}), charging will be stopped until the device cools to T_{REG} . During this time, the \overline{STAT} pin will be open-drain.

Disable

FAN54120 does not have a dedicated Enable/Disable pin. With a valid V_{IN} present, the system can disable charging by forcing the NTC pin higher than 1.5 V or creating an open circuit on the NTC pin. Although charging will cease, the device does not fully enter the low power sleep state. Battery discharge current will remain minimal due to device I_Q being drawn from V_{IN} .

POWER BACK OPERATION

Power Back provides an un-regulated output on the VIN pin to power peripheral accessories, using the battery as the power source. For a given battery voltage (V_{BAT}), the output will exhibit a finite output impedance equivalent to FAN54120 R_{DS} plus battery and protection switch ESR.

Power Back operation is initiated by forcing a transition of the \overline{STAT} pin from HIGH to below $V_{STAT(LO)}$. The IC ignores this input signal if V_{IN} is present, $V_{BAT} \leq V_{PBAK(UVLO)}$, or if V_{STAT} was never greater than $V_{STAT(HI)}$ prior to forcing it LOW. The normal \overline{STAT} pin functionality, associated with charging, is disabled during Power Back operation.

A soft-start feature is employed to limit inrush current from the battery to charge potentially large accessory input capacitors, parallel to C_{IN} .

During Power Back operation, the thermal shutdown protection threshold is T_{REG} . Thermal shutdown will result in latching open the current path between the BAT and VIN pins. To restore Power Back operation, the \overline{STAT} pin must be recycled HIGH, then back LOW.

In the event that a charging source is applied at the VIN pin while in Power Back mode, Power Back operation is automatically disabled, momentarily forcing the device into Sleep State during the Charging Validation Cycle.

PCB Layout Guideline

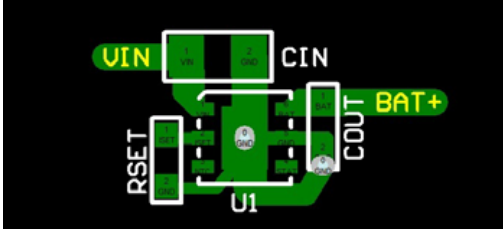

Figure 11. Example Layout, FAN54120MP (DFN)

Place C_{IN} and C_{OUT} as close possible to the IC. Connect the capacitors directly to the appropriate IC pins on the top layer. Reference the circuit to the system GND plane, typically on an inner layer, using a via in the IC DAP and/or at the GND side of C_{OUT} .

The GND side of R_{SET} should be routed with a trace directly to IC GND, rather than using a via to the GND plane. This prevents transient currents in GND plane from influencing the IC's current regulation.

The same practices should be applied to the WLCSP version. Due to the lack of a DAP on the CSP, the GND side of C_{IN} should be connected by via to the system GND plane.

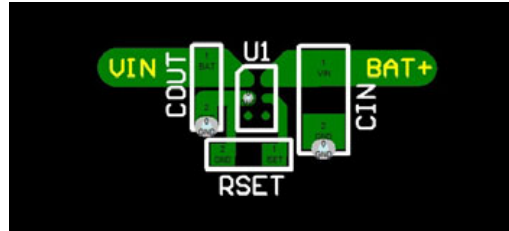
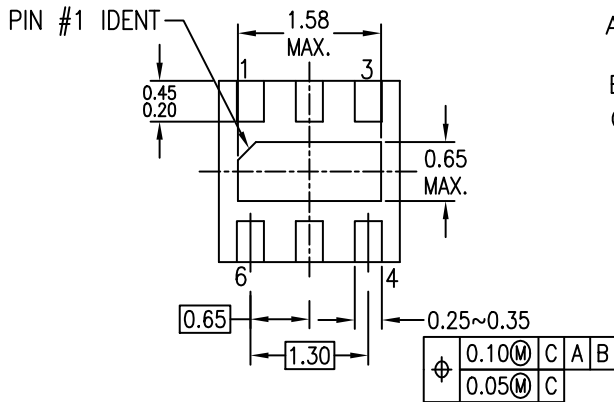
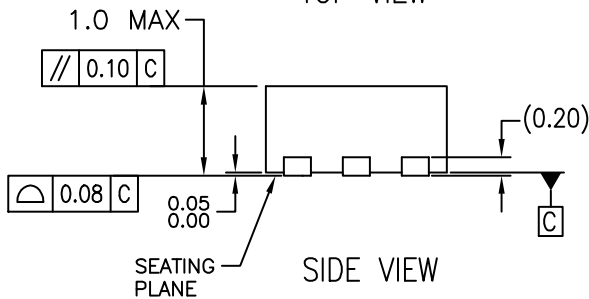
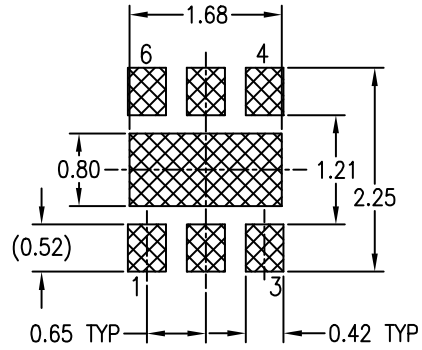
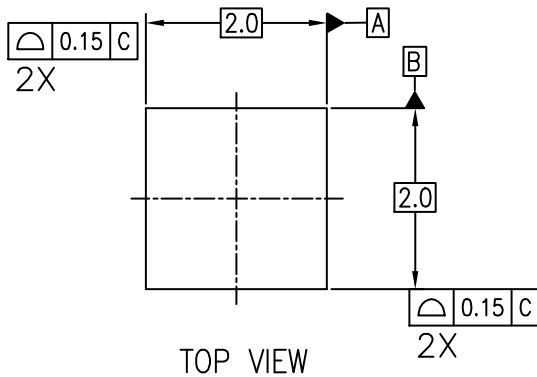

Figure 12. Example Layout, FAN54120UC (CSP)

DFN6 2x2, 0.65P
CASE 506DQ
ISSUE O

DATE 31 AUG 2016



NOTES:

- A. CONFORMS TO JEDEC REGISTRATION MO-229, VARIATION VCCC, DATED 11/2001
- B. DIMENSIONS ARE IN MILLIMETERS.
- C. DIMENSIONS AND TOLERANCES PER ASME Y14.5M, 1994

DOCUMENT NUMBER:	98AON13618G	Electronic versions are uncontrolled except when accessed directly from the Document Repository. Printed versions are uncontrolled except when stamped "CONTROLLED COPY" in red.
DESCRIPTION:	DFN6 2X2, 0.65P	PAGE 1 OF 1

ON Semiconductor and **ON** are trademarks of Semiconductor Components Industries, LLC dba ON Semiconductor or its subsidiaries in the United States and/or other countries. ON Semiconductor reserves the right to make changes without further notice to any products herein. ON Semiconductor makes no warranty, representation or guarantee regarding the suitability of its products for any particular purpose, nor does ON Semiconductor assume any liability arising out of the application or use of any product or circuit, and specifically disclaims any and all liability, including without limitation special, consequential or incidental damages. ON Semiconductor does not convey any license under its patent rights nor the rights of others.

MECHANICAL CASE OUTLINE

PACKAGE DIMENSIONS

ON Semiconductor®

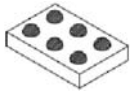

WLCSP6 1.36x0.76x0.581
CASE 567XQ
ISSUE O

DATE 03 APR 2019

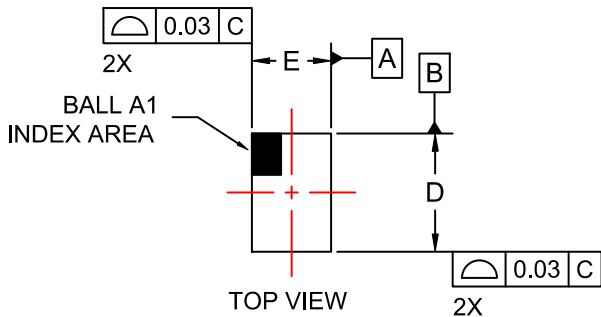

NOTES:

1. DIMENSIONING AND TOLERANCING PER ASME Y14.5M, 2009.
2. CONTROLLING DIMENSION: MILLIMETERS
3. DATUM C APPLIES TO THE SPHERICAL CROWN OF THE SOLDER BALLS

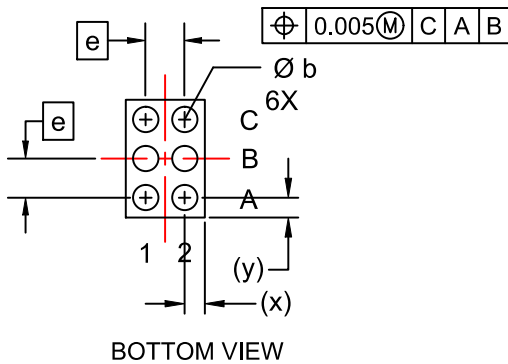
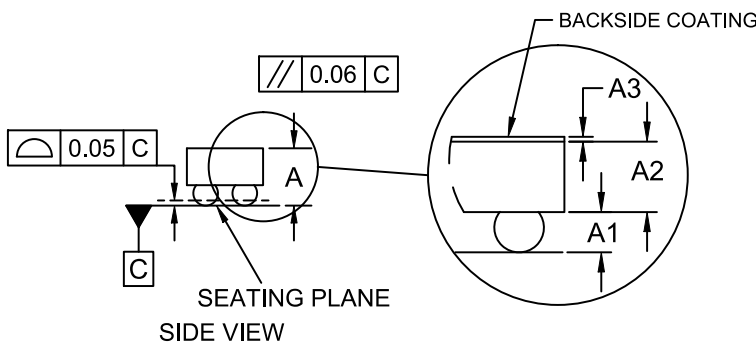

DIM	MILLIMETERS		
	MIN.	NOM.	MAX.
A	0.540	0.581	0.622
A1	0.183	0.203	0.223
A2	0.335	0.353	0.371
A3	0.022	0.025	0.028
b	0.240	0.260	0.280
D	1.33	1.36	1.39
E	0.73	0.76	0.79
e	0.40 BSC		
x	0.150	0.165	0.180
y	0.250	0.265	0.280

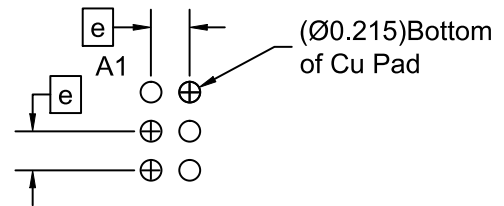

RECOMMENDED MOUNTING FOOTPRINT* (NSMD PAD TYPE)

*FOR ADDITIONAL INFORMATION ON OUR Pb-FREE STRATEGY AND SOLDERING DETAILS, PLEASE DOWNLOAD THE ON SEMICONDUCTOR SOLDERING AND MOUNTING TECHNIQUES REFERENCE MANUAL, SOLDERRM/D.

DOCUMENT NUMBER:	98AON02370H	Electronic versions are uncontrolled except when accessed directly from the Document Repository. Printed versions are uncontrolled except when stamped "CONTROLLED COPY" in red.
DESCRIPTION:	WLCSP6 1.36x0.76x0.581	PAGE 1 OF 1

ON Semiconductor and are trademarks of Semiconductor Components Industries, LLC dba ON Semiconductor or its subsidiaries in the United States and/or other countries. ON Semiconductor reserves the right to make changes without further notice to any products herein. ON Semiconductor makes no warranty, representation or guarantee regarding the suitability of its products for any particular purpose, nor does ON Semiconductor assume any liability arising out of the application or use of any product or circuit, and specifically disclaims any and all liability, including without limitation special, consequential or incidental damages. ON Semiconductor does not convey any license under its patent rights nor the rights of others.

onsemi, **Onsemi**, and other names, marks, and brands are registered and/or common law trademarks of Semiconductor Components Industries, LLC dba "**onsemi**" or its affiliates and/or subsidiaries in the United States and/or other countries. **onsemi** owns the rights to a number of patents, trademarks, copyrights, trade secrets, and other intellectual property. A listing of **onsemi**'s product/patent coverage may be accessed at www.onsemi.com/site/pdf/Patent-Marking.pdf. **onsemi** reserves the right to make changes at any time to any products or information herein, without notice. The information herein is provided "as-is" and **onsemi** makes no warranty, representation or guarantee regarding the accuracy of the information, product features, availability, functionality, or suitability of its products for any particular purpose, nor does **onsemi** assume any liability arising out of the application or use of any product or circuit, and specifically disclaims any and all liability, including without limitation special, consequential or incidental damages. Buyer is responsible for its products and applications using **onsemi** products, including compliance with all laws, regulations and safety requirements or standards, regardless of any support or applications information provided by **onsemi**. "Typical" parameters which may be provided in **onsemi** data sheets and/or specifications can and do vary in different applications and actual performance may vary over time. All operating parameters, including "Typicals" must be validated for each customer application by customer's technical experts. **onsemi** does not convey any license under any of its intellectual property rights nor the rights of others. **onsemi** products are not designed, intended, or authorized for use as a critical component in life support systems or any FDA Class 3 medical devices or medical devices with a same or similar classification in a foreign jurisdiction or any devices intended for implantation in the human body. Should Buyer purchase or use **onsemi** products for any such unintended or unauthorized application, Buyer shall indemnify and hold **onsemi** and its officers, employees, subsidiaries, affiliates, and distributors harmless against all claims, costs, damages, and expenses, and reasonable attorney fees arising out of, directly or indirectly, any claim of personal injury or death associated with such unintended or unauthorized use, even if such claim alleges that **onsemi** was negligent regarding the design or manufacture of the part. **onsemi** is an Equal Opportunity/Affirmative Action Employer. This literature is subject to all applicable copyright laws and is not for resale in any manner.

ADDITIONAL INFORMATION

TECHNICAL PUBLICATIONS:

Technical Library: www.onsemi.com/design/resources/technical-documentation
onsemi Website: www.onsemi.com

ONLINE SUPPORT: www.onsemi.com/support

For additional information, please contact your local Sales Representative at www.onsemi.com/support/sales