

ON Semiconductor

Is Now

onsemi™

To learn more about onsemi™, please visit our website at
www.onsemi.com

onsemi and **onsemi** and other names, marks, and brands are registered and/or common law trademarks of Semiconductor Components Industries, LLC dba "**onsemi**" or its affiliates and/or subsidiaries in the United States and/or other countries. **onsemi** owns the rights to a number of patents, trademarks, copyrights, trade secrets, and other intellectual property. A listing of **onsemi** product/patent coverage may be accessed at www.onsemi.com/site/pdf/Patent-Marking.pdf. **onsemi** reserves the right to make changes at any time to any products or information herein, without notice. The information herein is provided "as-is" and **onsemi** makes no warranty, representation or guarantee regarding the accuracy of the information, product features, availability, functionality, or suitability of its products for any particular purpose, nor does **onsemi** assume any liability arising out of the application or use of any product or circuit, and specifically disclaims any and all liability, including without limitation special, consequential or incidental damages. Buyer is responsible for its products and applications using **onsemi** products, including compliance with all laws, regulations and safety requirements or standards, regardless of any support or applications information provided by **onsemi**. "Typical" parameters which may be provided in **onsemi** data sheets and/or specifications can and do vary in different applications and actual performance may vary over time. All operating parameters, including "Typicals" must be validated for each customer application by customer's technical experts. **onsemi** does not convey any license under any of its intellectual property rights nor the rights of others. **onsemi** products are not designed, intended, or authorized for use as a critical component in life support systems or any FDA Class 3 medical devices or medical devices with a same or similar classification in a foreign jurisdiction or any devices intended for implantation in the human body. Should Buyer purchase or use **onsemi** products for any such unintended or unauthorized application, Buyer shall indemnify and hold **onsemi** and its officers, employees, subsidiaries, affiliates, and distributors harmless against all claims, costs, damages, and expenses, and reasonable attorney fees arising out of, directly or indirectly, any claim of personal injury or death associated with such unintended or unauthorized use, even if such claim alleges that **onsemi** was negligent regarding the design or manufacture of the part. **onsemi** is an Equal Opportunity/Affirmative Action Employer. This literature is subject to all applicable copyright laws and is not for resale in any manner. Other names and brands may be claimed as the property of others.



ON Semiconductor

36 W Type C Interface PD3.0/QC3.0 Adapter Solution

Device	Application	Input Voltage	Output Power	Topology	I/O Isolation
NCP1340B3 NCP43080D NCP4371BBCD NTMFS6B03 NTTFS4932N	Smart phone, PAD and NB adapter supporting PD3.0 and QC3.0 protocol	90 Vac to 264 Vac	PD---36W QC---32W	QR Flyback	Isolated (3 kV)

	PD Output Specification	QC Output Specification
Output Voltage	5V,9V,12V,15V and 20V	QC2.0: 5V,9V,12V QC3.0: 4V-12V
Ripple	<100mV p/p @ all output, 115 Vac	<100mV p/p @ all output, 115 Vac
Nominal Current	5V,9V,12V/3A, 15V/2.4A, 20V/3A	QC2.0: 5V/3A, 9V/2.67A, 12V/2.67A QC3.0: 4V-8V/3A, 8V-12V/2.67A
Max Current	5V,9V,12V/3A, 15V/2.4A, 20V/3A	QC2.0: 5V/3A, 9V/2.67A, 12V/2.67A QC3.0: 4V-8V/3A, 8V-12V/2.67A
Min Current	zero	zero

Efficiency	>91%@20V1.8A, 115Vac&230Vac
Input Protection	Fuse
Operating Temp. Range	0 to +45°C
Cooling Method	Convection
Standby Power	<75 mW @ 5V & 230 Vac (No cable plug in)
Power Density	1.2W/cm ³

Circuit Description

This design note describes a 36 watt, Type C interface PD3.0/QC3.0, universal AC input, constant voltage power supply intended for smart phone, PAD and NB adaptor supporting PD3.0 and QC3.0 protocol, where isolation from the AC mains is required, and low cost, high efficiency, and low standby power are essential.

The featured power supply is a simple QR Flyback topology utilizing ON Semiconductor's NCP1340 HF PWM controller, NCP43080 synchronous rectified controller and NCP4371 QC3.0 protocol controller combined Cypress's CCG3 PD protocol controller. This Design Note provides the complete circuit schematic details and BOM for 36W Type C Interface PD3.0/QC3.0 adaptor solution which supports

PD output (5V-9V/3A, 15V2.4A and 20V/1.8A), QC2.0 output (5V/3A, 9V/2.67A, 12V/2.67A) and QC3.0 output (4V-8V/3A, 8V-12V/2.67A).

This design combined with NCP4371 and CCG3 to support QC3.0 and PD3.0, QC protocol is transferred by CCG3 and sent to NCP4371, PD protocol is transformed to QC3.0 protocol and sent to NCP4371 to change output voltage. NCP4371 provides QC protocol decode and CC/CV control.

This design also proposed a dual auxiliary power supply solution that low voltage Vcc supplies to controller in low output and high voltage Vcc supplies to controller in high output also shut down the zener bias of high voltage regulator in order to increase the efficiency.

This design uses secondary synchronous rectifier with an external Vcc supply to ensure normal work of synchronous controller at low output, a pulse regulator for external Vcc is used to reduce power consumption.

Key Features

1. Universal AC input range (90 – 264 Vac)
2. Very low standby (no load) power consumption
3. Very low ripple and noise
4. Inherent SCP and OCP protection
5. High frequency operation
6. High power density (1.2 W/cm³)
7. Quasi-Resonant current mode control with Valley Switching
8. Quasi-Resonant current mode control with Valley Switching
9. Valley lockout avoids audible noise at valley jumping operation
10. Support TYPE C interface PD3.0 and QC3.0 Class A&B specification
11. Adaptive Output OVP and UVP
12. Output CC @QC2.0 and QC3.0 mode
13. Two PCB boards back-to-back assembled
14. Board size: 51mmx28mmx21mm

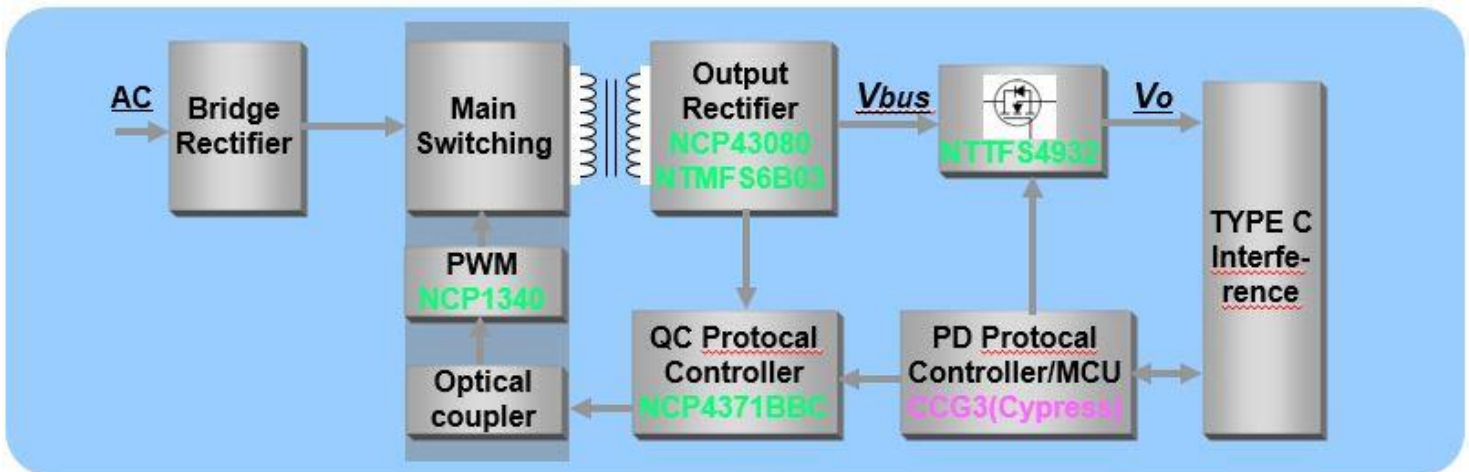

Figure 1, Overall cycle of 36W TYPE C Interface PD3.0/QC3.0 Adapter Solution

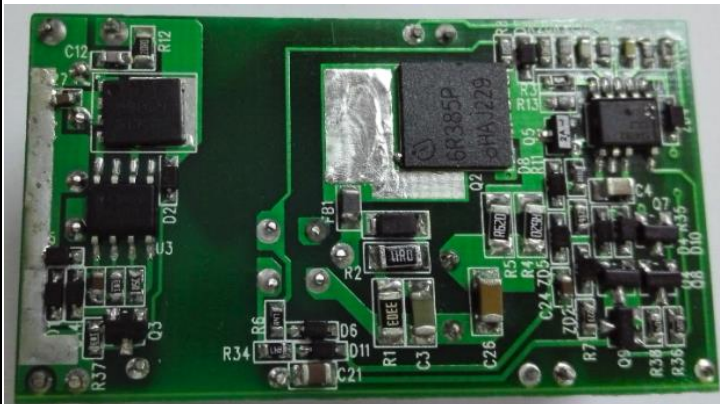

Figure 2, Top view of demoboard

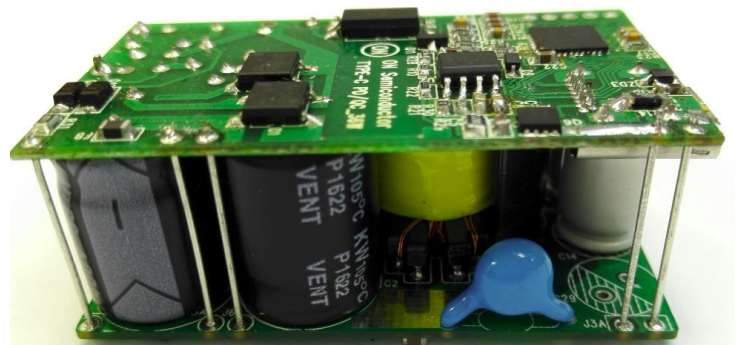
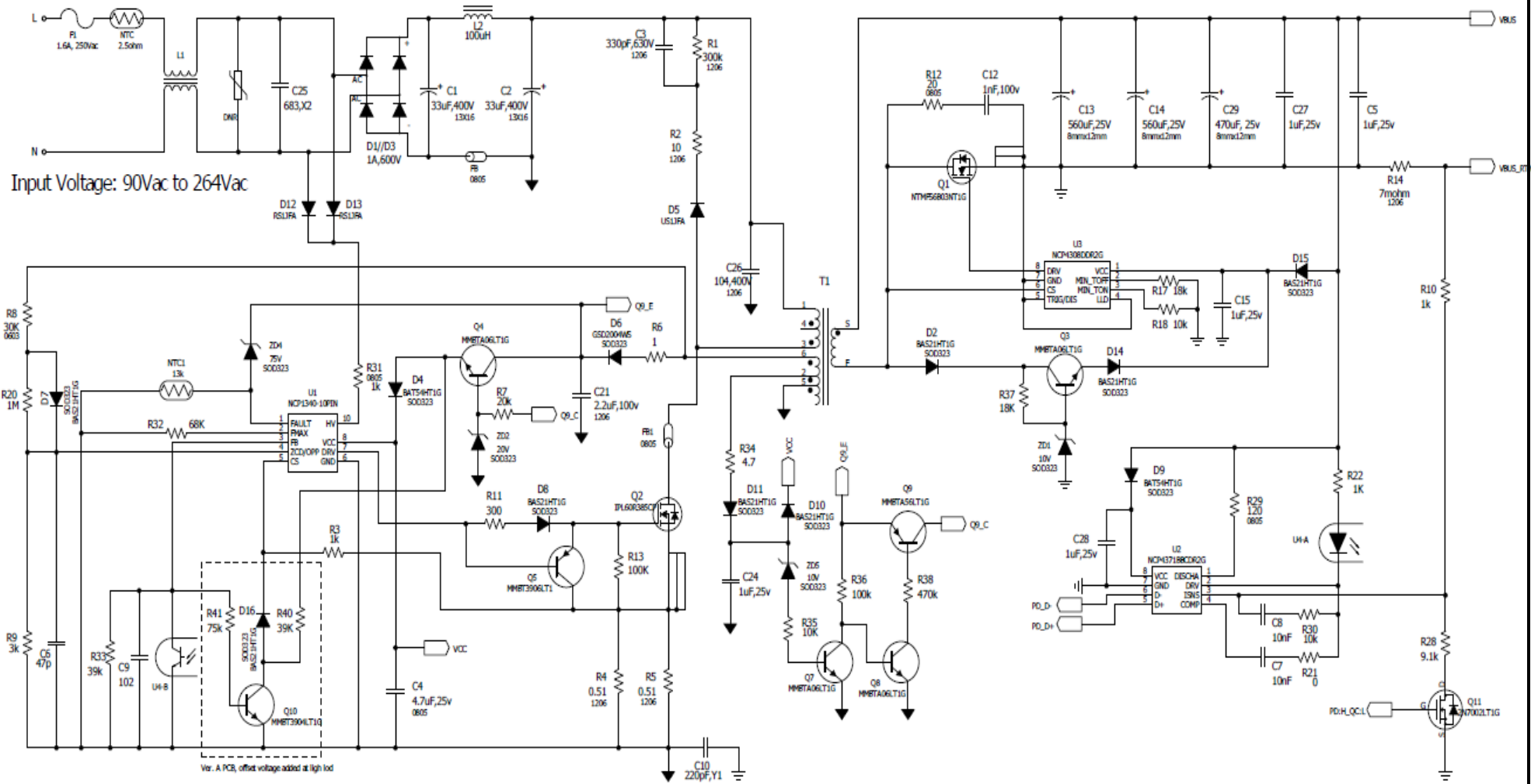
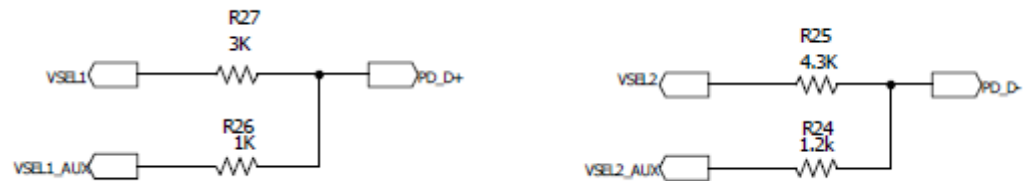
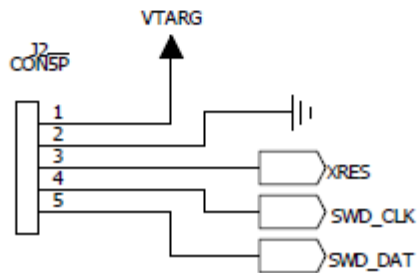
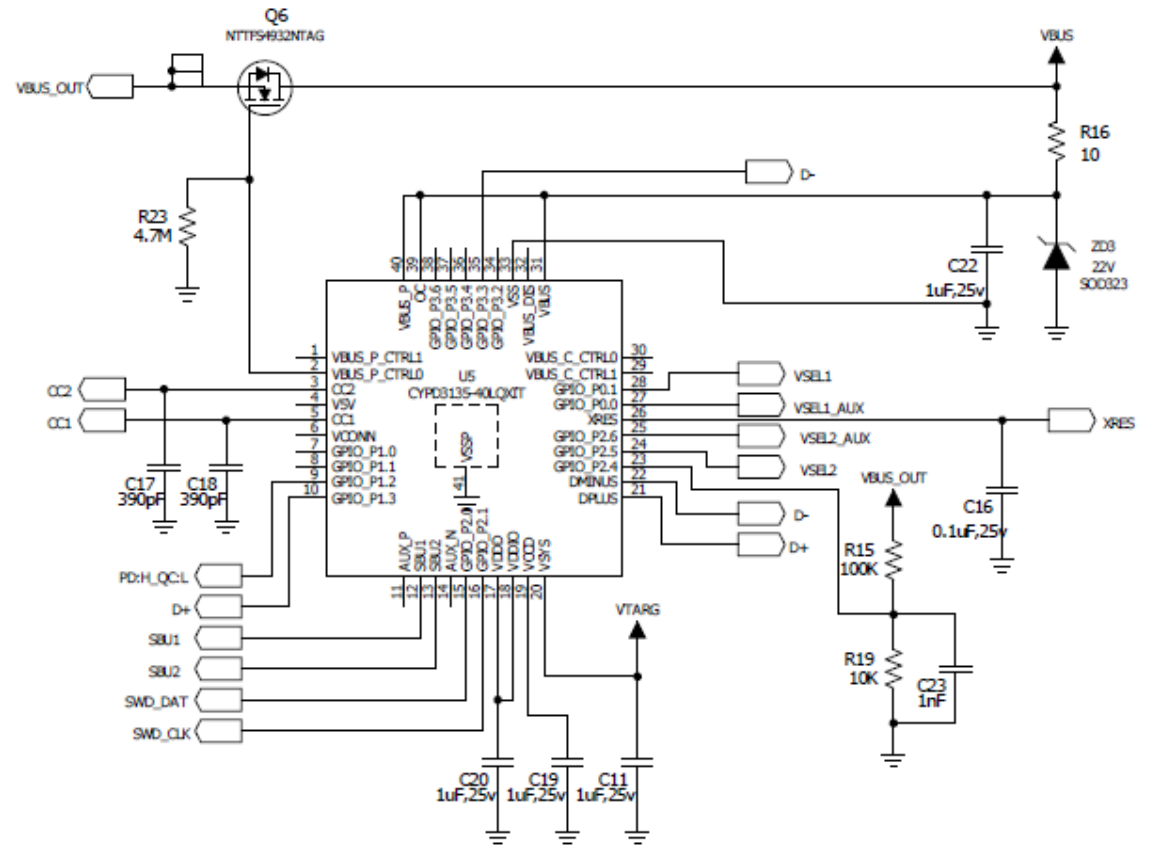
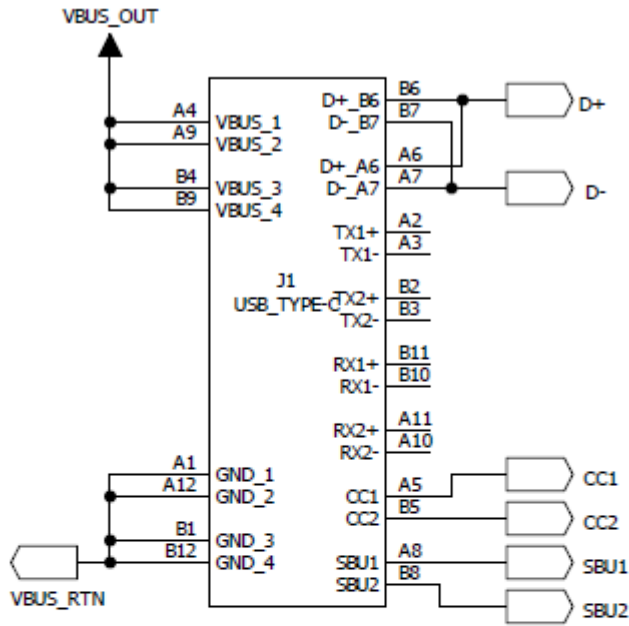

Figure 3, Side view of demoboard

DN05099/D Circuit Schematic



DN05099/D Circuit Schematic (Continued)



T1 Transformer Designs (Available from Wurth Electronics)

CUSTOMER TERMINAL	RoHS	LEAD(Pb)-FREE
Sn 96%, Ag 4%	Yes	Yes

more than you expect



ELECTRICAL SPECIFICATIONS @ 25° C unless otherwise noted:

PARAMETER	TEST CONDITIONS	VALUE
D.C. RESISTANCE	11-12 @20°C	0.590 ohms max.
D.C. RESISTANCE	3-1 @20°C	0.420 ohms max.
D.C. RESISTANCE	1-10 @20°C	0.220 ohms max.
D.C. RESISTANCE	S-F @20°C	0.022 ohms max.
INDUCTANCE	11-12 10kHz, 1V, Ls	460.00µH ±10%
SATURATION CURRENT	11-12 20% rolloff from initial	1.5A
LEAKAGE INDUCTANCE	11-12 $t_{le}(1+3+10+S+F)$, 100kHz, 1V, Ls	5µH max.
DIELECTRIC	1-S $t_{le}(1+2+3+10+11+12)$, 3750VAC, 1 second	3000VAC, 1 minute
DIELECTRIC	S-CORE 3750VAC, 1 second	3000VAC, 1 minute
URNS RATIO	(11-12):(3-1)	3.25:1, ±2%
URNS RATIO	(11-12):(1-10)	6.5:1, ±2%
URNS RATIO	(11-12):(S-F)	6.5:1, ±2%

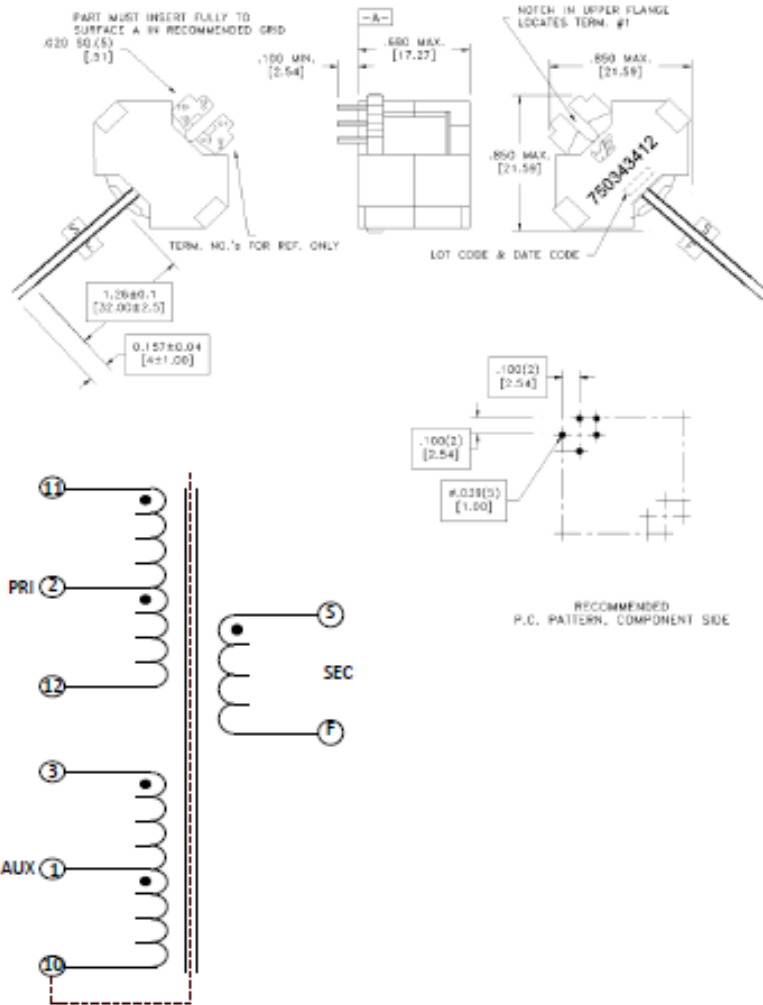

GENERAL SPECIFICATIONS:

OPERATING TEMPERATURE RANGE: -40°C to +125°C including temp rise.

Designed to comply with the following requirements as defined by IEC60950-1, EN60950-1, UL60950-1/CSA60950-1 and AS/NZS60950.1:

- Reinforced insulation for a primary circuit at a working voltage of 265Vrms, 400Vpeak, Overvoltage Category II.

Wire insulation & RoHS status not affected by wire color. Wire insulation color may vary depending on availability.

DFM	Packaging Specifications	<p>CONVENTION PLACEMENT</p>	Tolerances unless otherwise specified: Angles: ±1° Decimals: ±.005 [.13] Fractions: ±1/64 Footprint: ±.001 [.03]	DRAWING TITLE	PART NO.
DATE	Method: Tray		This drawing is dual dimensioned. Dimensions in brackets are in millimeters.	TRANSFORMER	750343412
ENG	HWE				
REV.	01				
DATE	2/17/2017				

SPECIFICATION SHEET 1 OF 1

Standby Power at 5V Output (Cable unplug) @ 90 Vac to 264 Vac Input

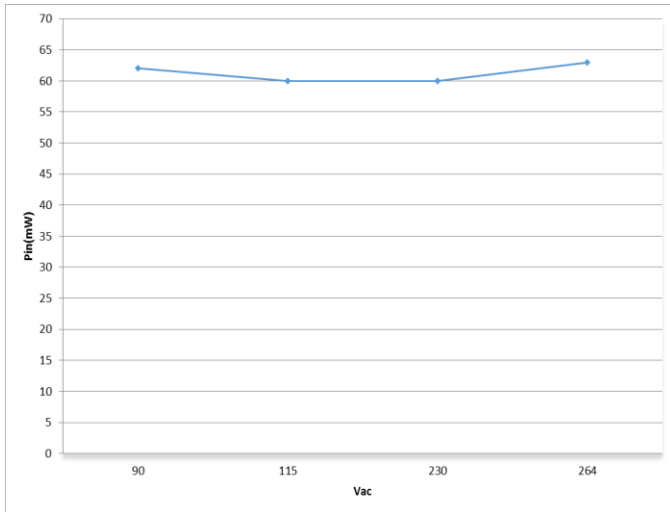

Average Efficiency @ 115 Vac & 230 Vac Input

5V output

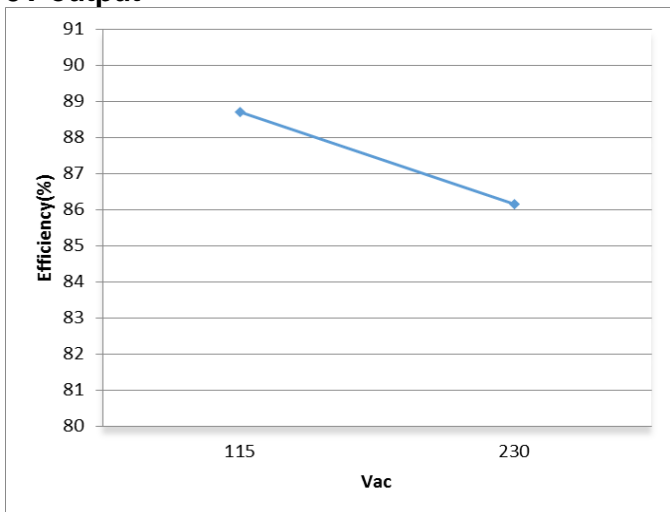

PD_9V output

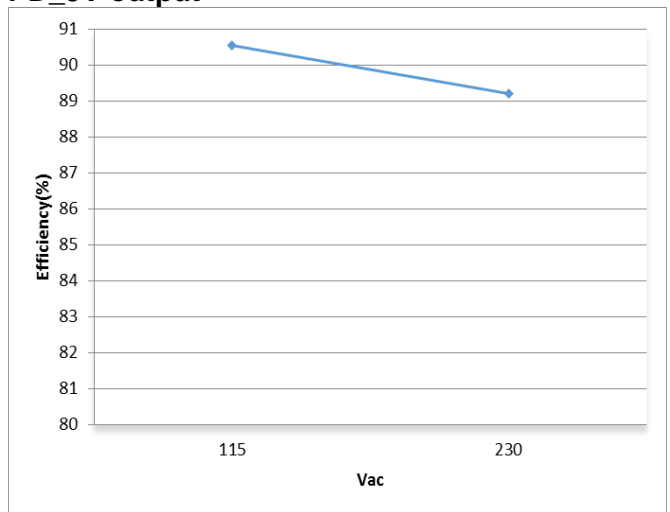

PD_15V output

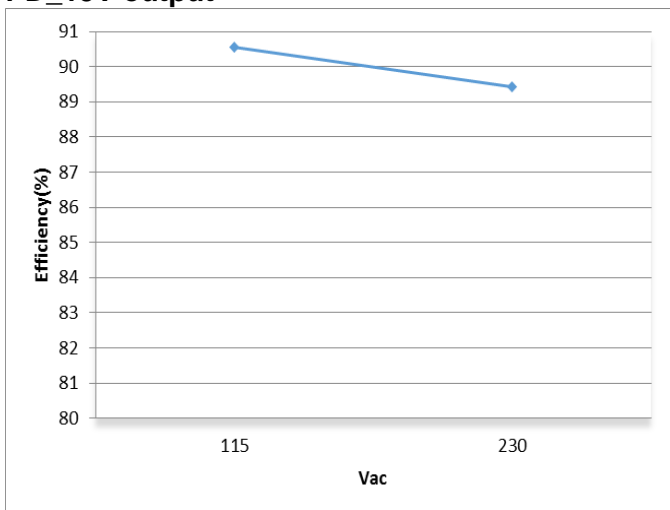

PD_20V output

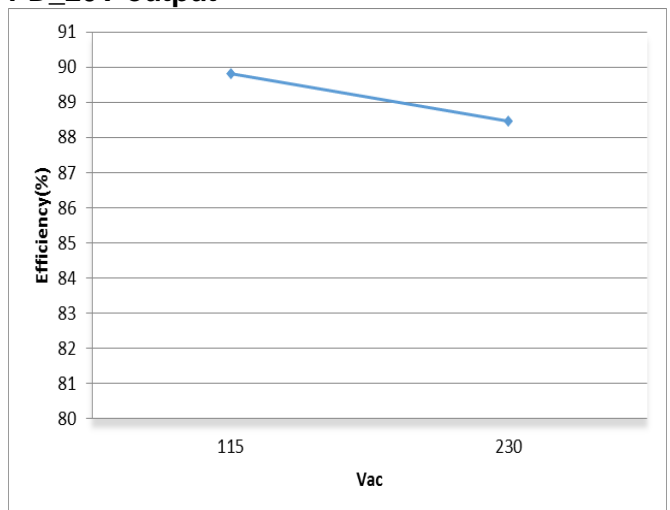

Average Efficiency @ 115 Vac & 230 Vac Input (Continued)

QC_9V output

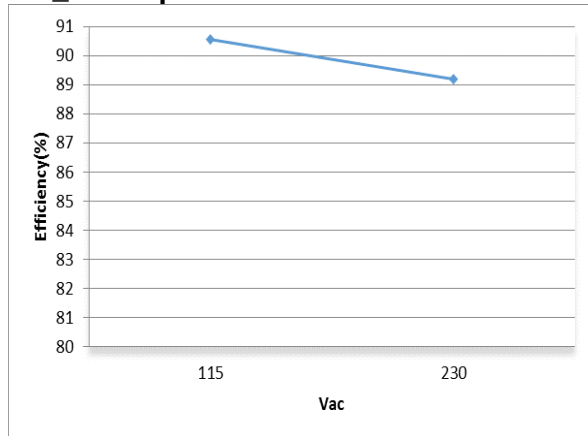

QC_12V output

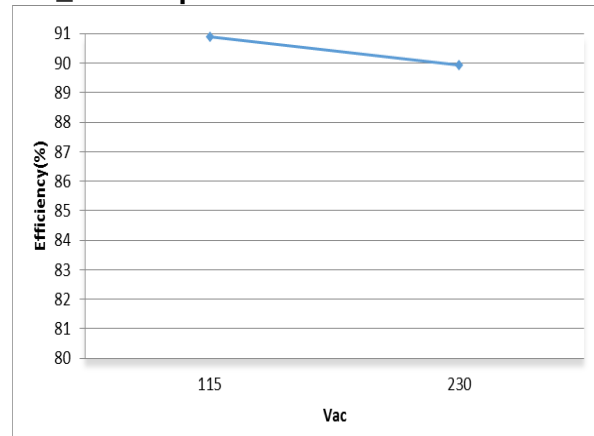

Efficiency vs Output Load Curves @ 115 Vac & 230 Vac Input

Test condition: all efficiency are tested at board end

5V output

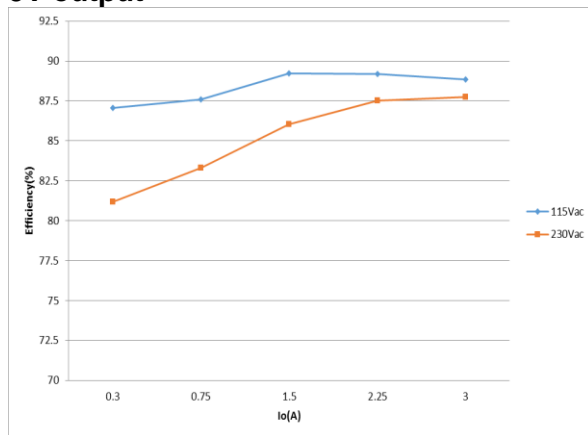

PD_9V output

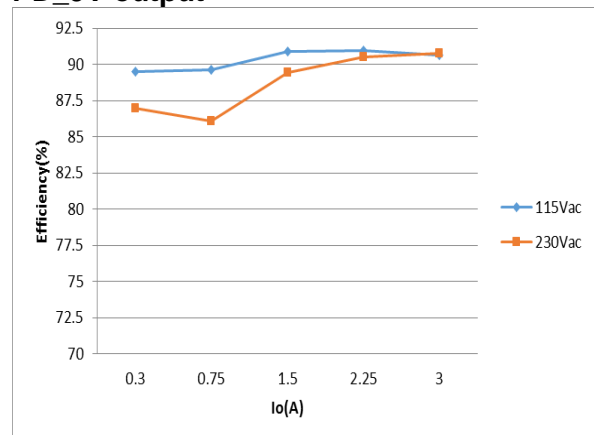

QC_12V output

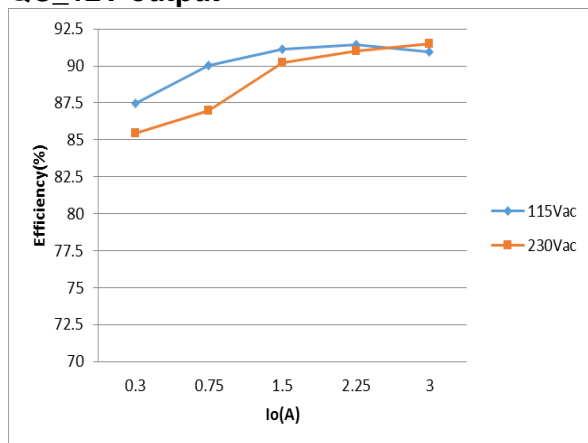

PD_15V output

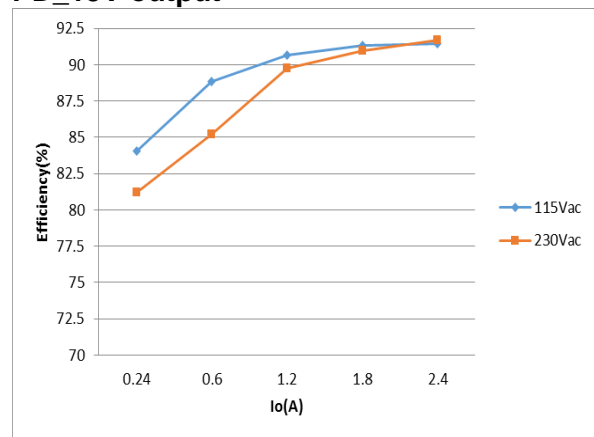

Efficiency vs Output Load Curves @ 115 Vac & 230 Vac Input (Continued)

Test condition: all efficiency are tested at board end

PD_20V output

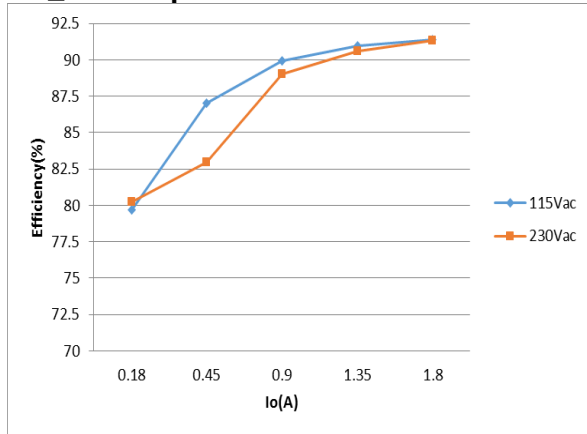

Output Ripple @ 115 Vac Input

5V3A output (CH4: Vo)

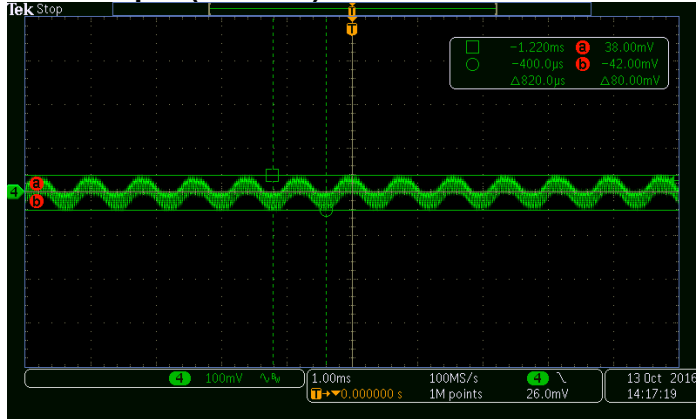

9V3A output (CH4: Vo)

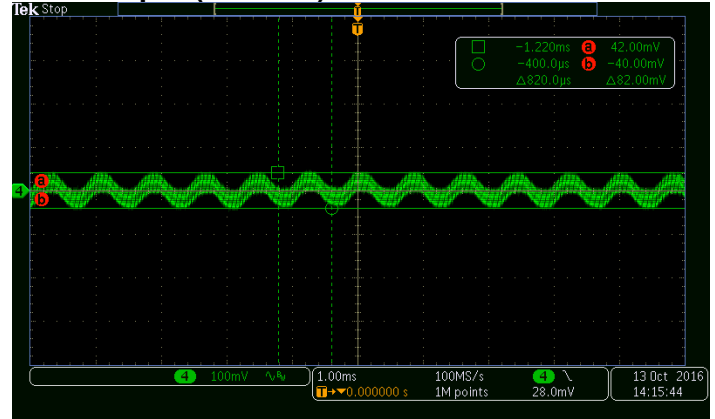

12V3A output (CH4: Vo)

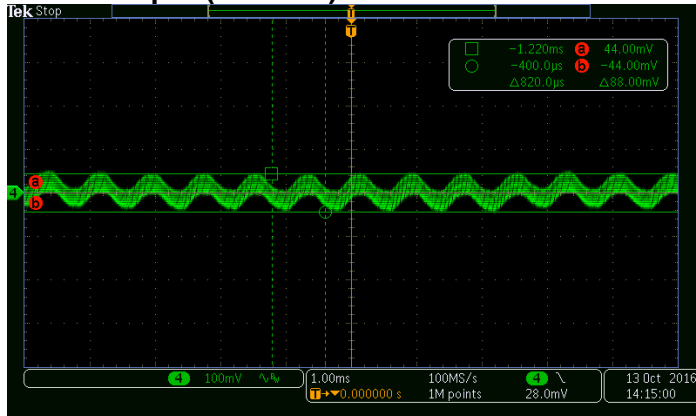

15V2.4A output (CH4: Vo)

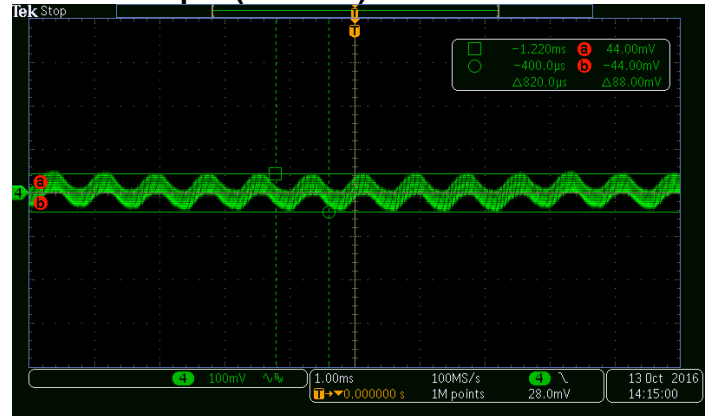

Output Ripple @ 115 Vac Input (Continued)

20V1.8A output (CH4: Vo)

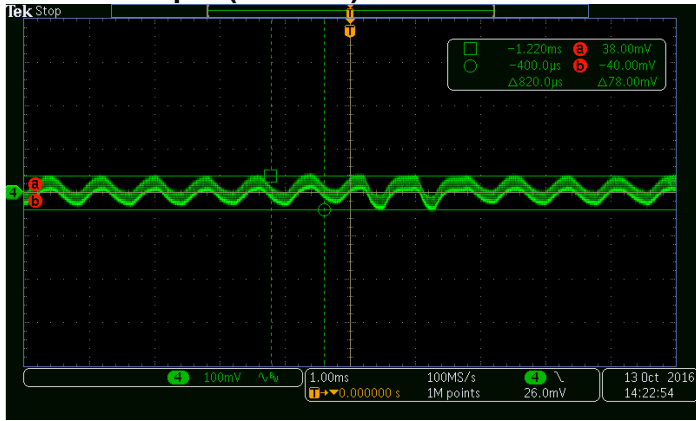

IV Curve @ 115 Vac & 230 Vac Input

5V output

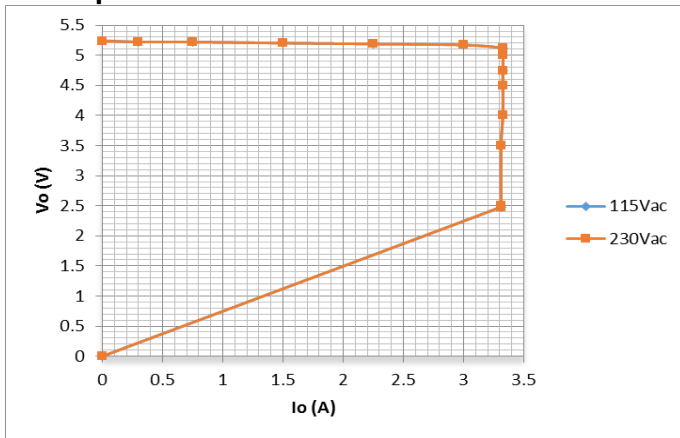

PD_9V output

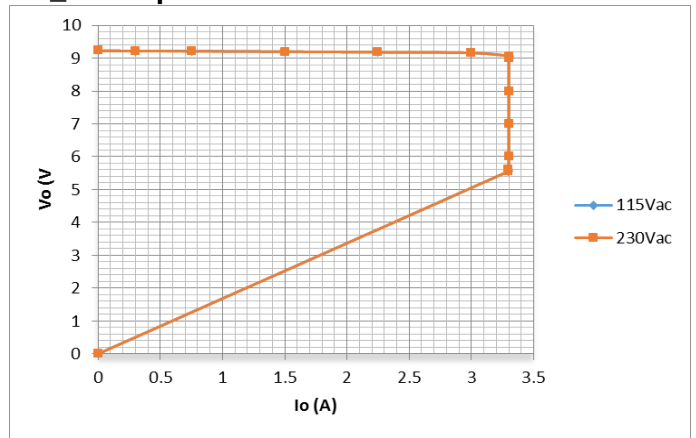

PD_15V output

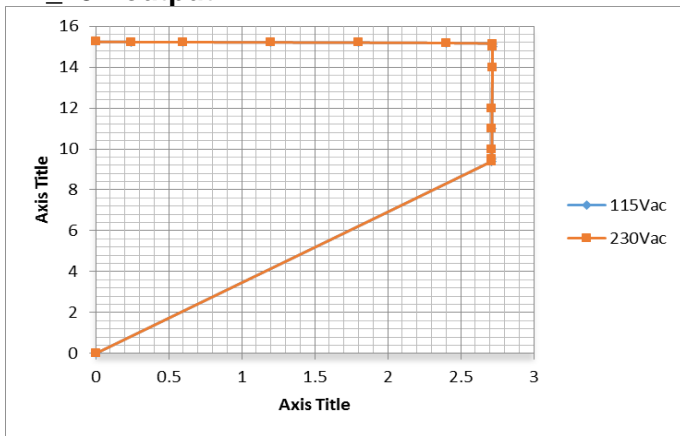

PD_20V output

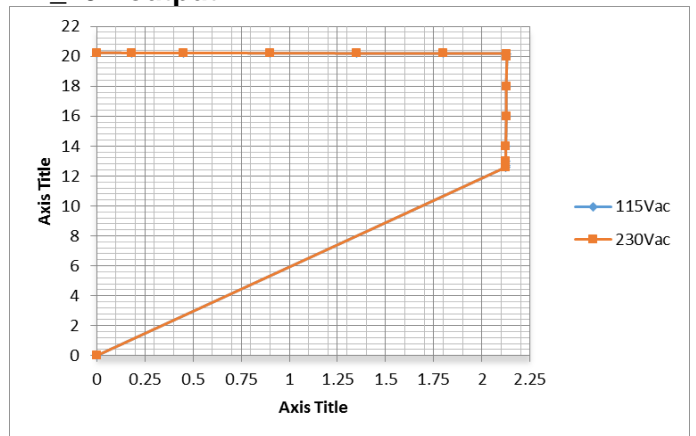

IV Curve @ 115 Vac & 230 Vac Input (Continued)

QC_9V output

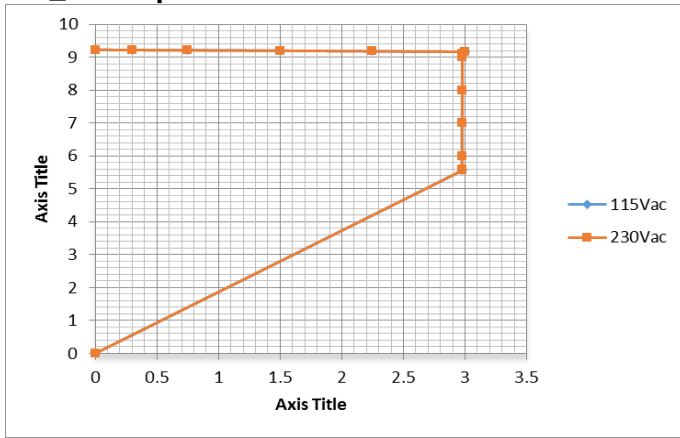

QC_12V output

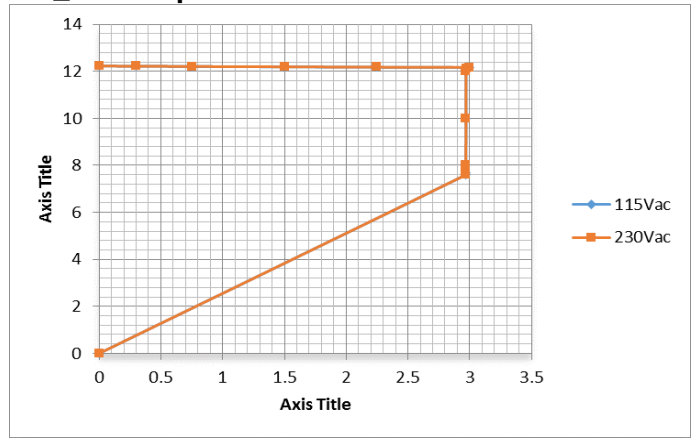

PD Transition

5V to 9V to 15V (CH4: Vo)

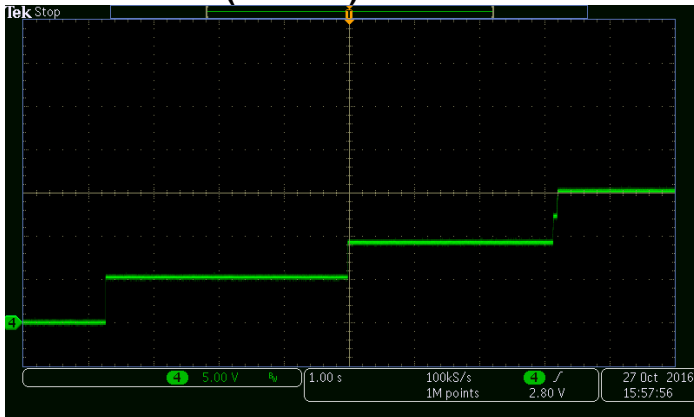

20V to 5V (CH1: Vdrain, CH2: Vbus, CH4: Vo)

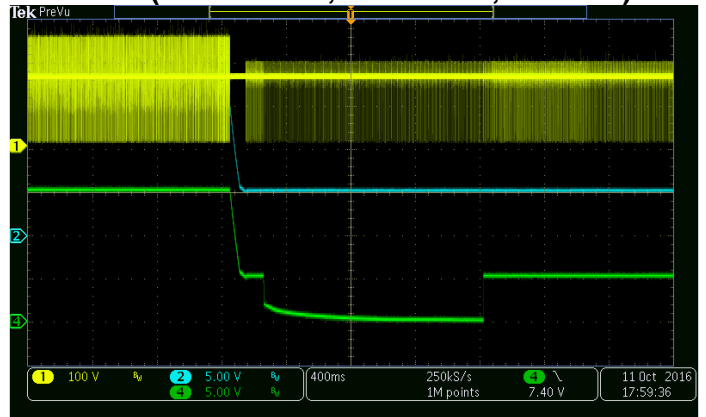

Voltage Rise

QC 2.0 Mode (CH2: D-, CH3: D+, CH4: Vo)

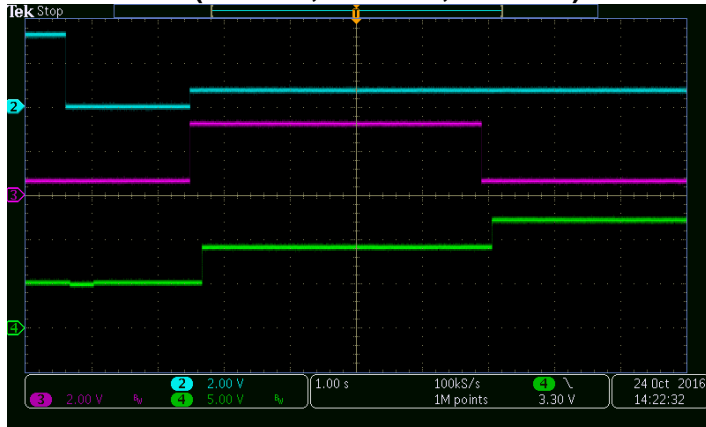

QC3.0 CNT Mode (CH2: D-, CH3: D+, CH4: Vo)



Voltage Fall

QC3.0 CNT Mode (CH2: D-, CH3: D+, CH4: Vo)

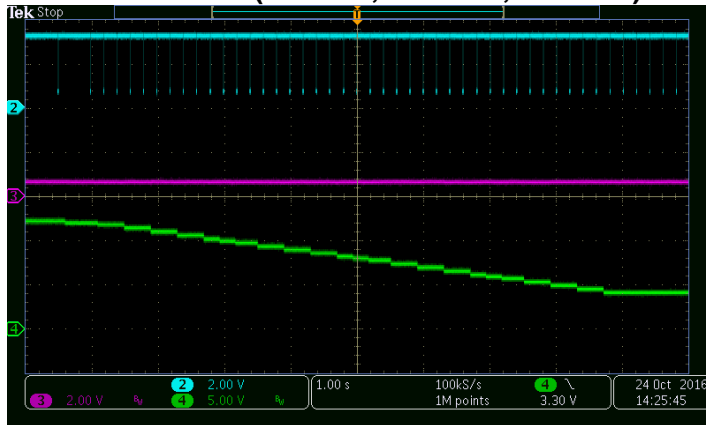

Discharge Time @ No Load

PD (20V to 5V) (CH1: Vdrain, CH4: Vo)

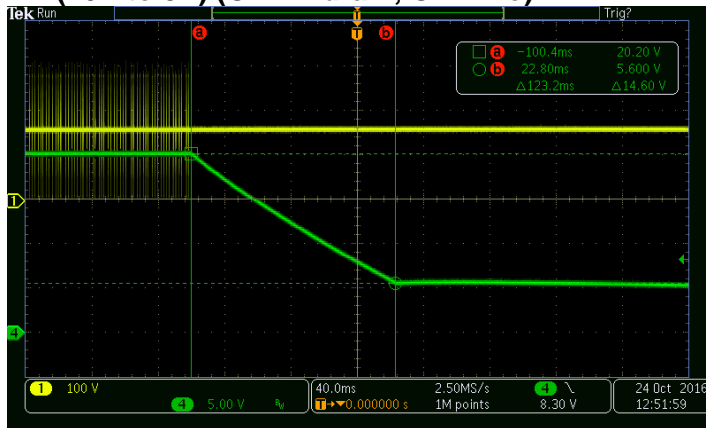

QC (12V to 5V) (CH1: Vdrain, CH4: Vo)

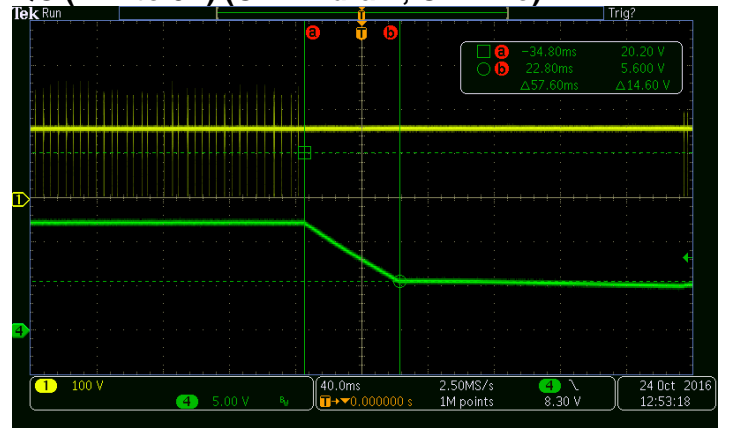

Dynamic Test @ 115 Vac Input

5V3A (CH3: Io, CH4: Vo)

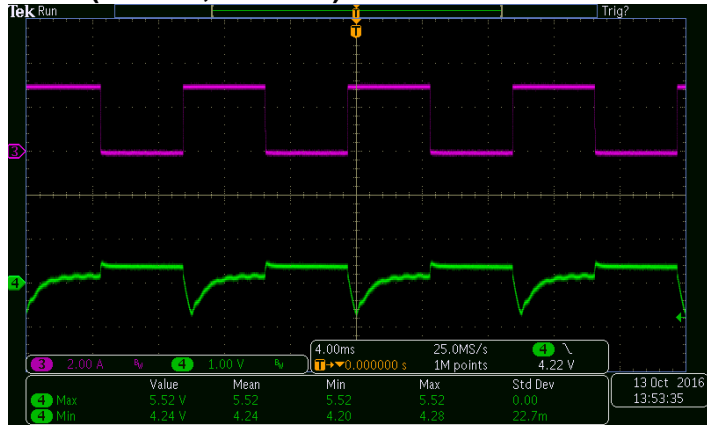

Test condition: 0-3A, 10mS cycle, 125mA/Us
1m cable, tested at E-load

9V3A (CH3: Io, CH4: Vo)

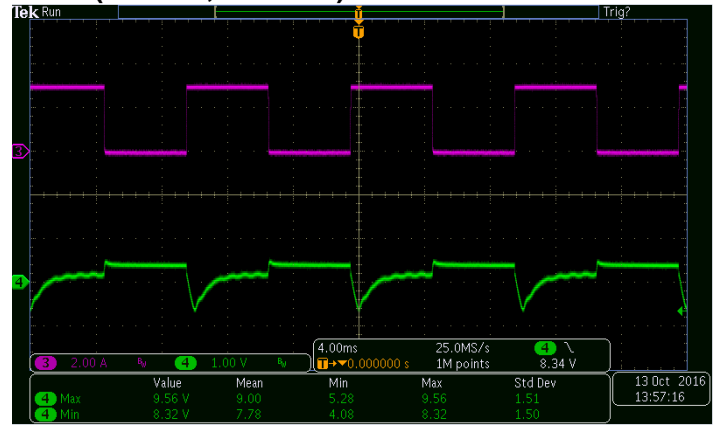

Test condition: 0-3A, 10mS cycle, 125mA/Us
1m cable, tested at E-load

12V3A (CH3: Io, CH4: Vo)

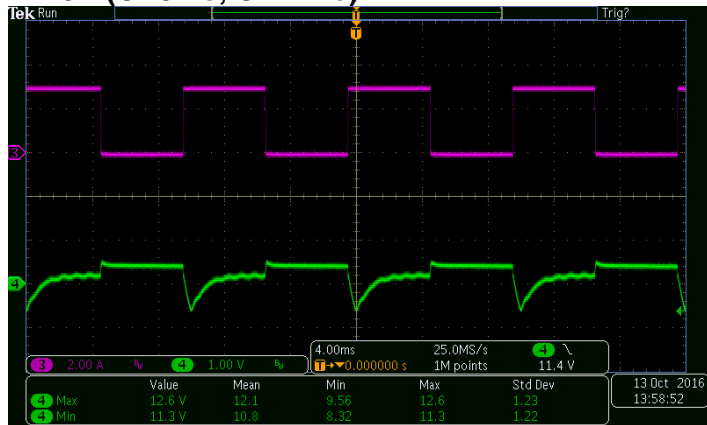

Test condition: 0-3A, 10mS cycle, 125mA/Us
1m cable, tested at E-load

15V2.4A (CH3: Io, CH4: Vo)

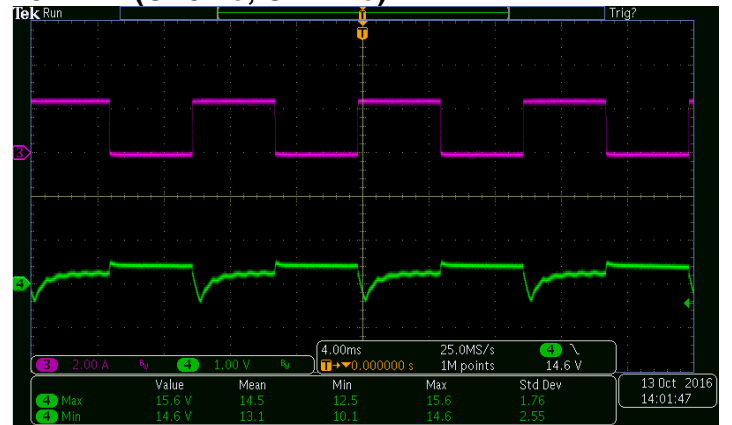

Test condition: 0-2.4A, 10mS cycle, 125mA/Us
1m cable, tested at E-load

20V1.8A (CH3: Io, CH4: Vo)

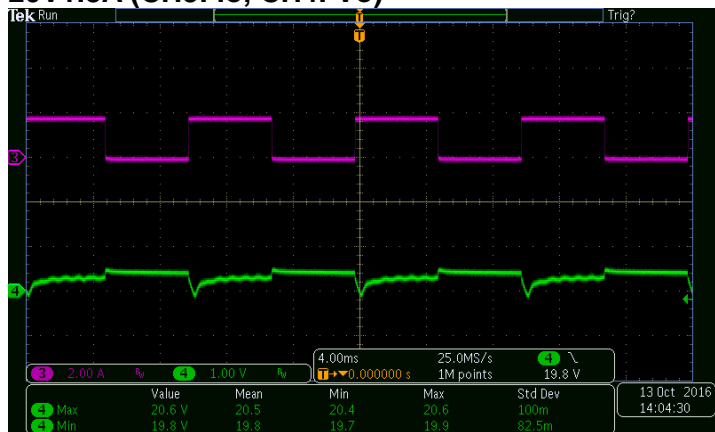

Test condition: 0-1.8A, 10mS cycle, 125mA/Us
1m cable, tested at E-load

OCF @ 264 Vac Input, 5 Vdc Output

Primary & Secondary FET Drain Voltage @ 264 Vac input, 20V1.8A

Test condition: Pi=1.8W at SCP

(CH1: Vdrain, CH2: Vsyn FET, CH3: Io, CH4: Vo)

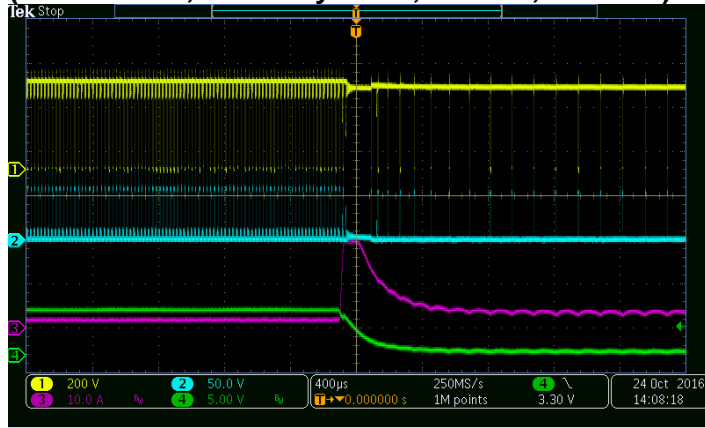

(CH1: Vdrain, CH2: Vsyn FET)

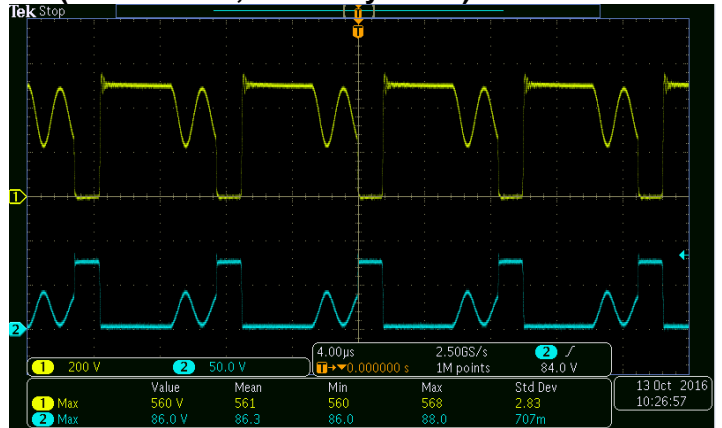

Synchronic Drive @ 115 Vac Input

5V3A (CH2: Pri PWM, CH3: Syn DRV)

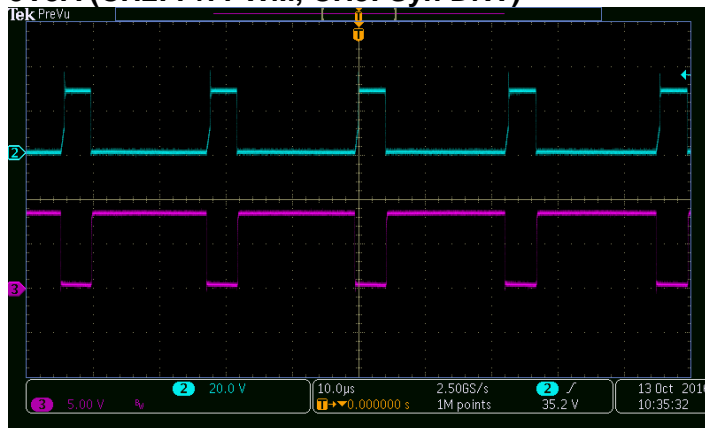

9V3A (CH2: Pri PWM, CH3: Syn DRV)

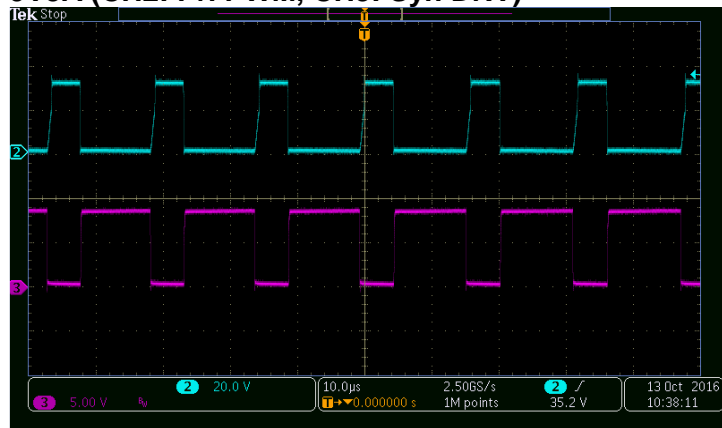

12V3A (CH2: Pri PWM, CH3: Syn DRV)

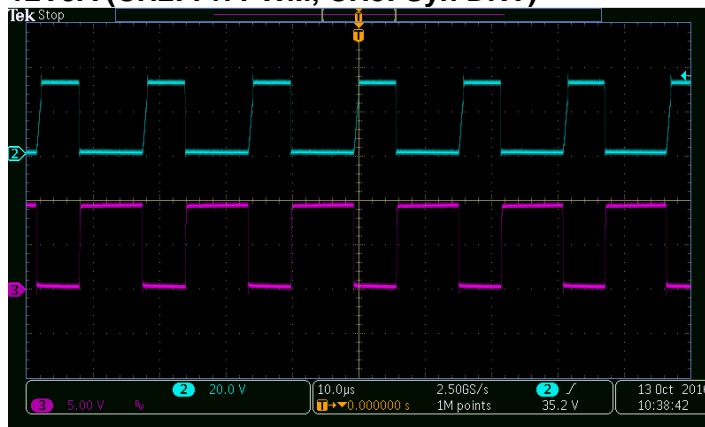

15V2.4A (CH2: Pri PWM, CH3: Syn DRV)

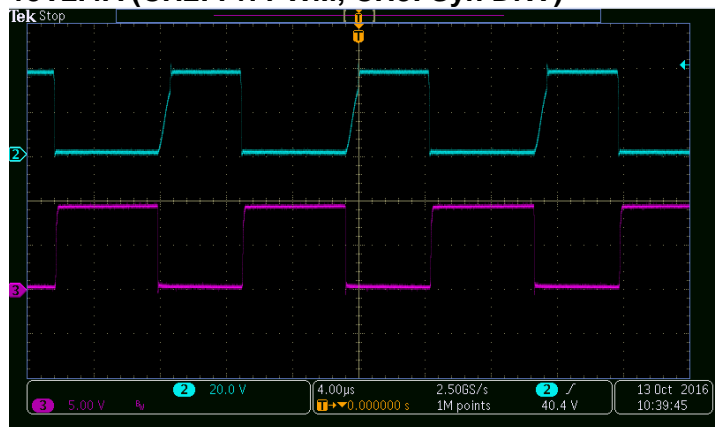

Thermal Image @ 20V1.8A Output

Input	Component Side	Back side
90 Vac	<p>FLUKE 57.3°C 自动 2 84.7 最大 81.4 最小 25.8 60.9 24.0 $\epsilon=0.95$ BG=22.0 T=100% 6/17/16 10:15:00 AM</p>	<p>FLUKE 53.2°C 自动 2 92.2 最大 90.8 最小 24.9 72.2 24.4 $\epsilon=0.95$ BG=22.0 T=100% 6/17/16 11:35:28 AM</p>
150 Vac	<p>FLUKE 45.6°C 自动 1 72.6 最大 72.2 最小 25.1 51.2 23.9 $\epsilon=0.95$ BG=22.0 T=100% 6/17/16 12:06:46 PM</p>	<p>FLUKE 57.6°C 自动 1 77.5 最大 76.6 最小 26.8 58.5 25.9 $\epsilon=0.95$ BG=22.0 T=100% 6/17/16 11:52:02 AM</p>
230 Vac	<p>FLUKE 52.8°C 自动 1 74.5 最大 73.8 最小 25.0 52.2 24.3 $\epsilon=0.95$ BG=22.0 T=100% 6/17/16 12:03:05 PM</p>	<p>FLUKE 47.9°C 自动 2 86.8 最大 87.8 最小 24.2 51.3 23.7 $\epsilon=0.95$ BG=22.0 T=100% 6/17/16 12:02:30 PM</p>
264 Vac	<p>FLUKE 35.0°C 自动 2 83.7 最大 82.6 最小 21.7 59.3 21.1 $\epsilon=0.95$ BG=22.0 T=100% 6/17/16 10:51:34 AM</p>	<p>FLUKE 56.1°C 自动 2 96.2 最大 96.9 最小 23.9 49.9 23.2 $\epsilon=0.95$ BG=22.0 T=100% 6/17/16 10:58:54 AM</p>

**DN05099/D
BOM**

Item	Qty	Reference	Type	Part Name	MFR	Value	Package	Description
1	1	Q11	NMOSFET	2N7002LT1G	ON		SOT23	Small signal MOSFET
2	1	C16	Ceramic Capacitor	C1608X7R1E104K/885012206071	TDK/WE	0.1uF, 25v	603	Capacitor, Ceramic, 25V, 10%
3	2	C9 C23	Ceramic Capacitor	Std/885012206083	std/WE	1nF	603	Capacitor, Ceramic, 50V, 10%
4	1	C26	Ceramic Capacitor	C3216X7T2W104K	TDK	100nF, 400V	1206	Capacitor, Ceramic, Chip, 5%
5	2	C7 C8	Ceramic Capacitor	Std/885012206080	std/WE	10nF	603	Capacitor, Ceramic, 50V, 10%
6	1	C12	Ceramic Capacitor	C1608C0G2A102J/885012206080	TDK/WE	1nF, 100v	603	Capacitor, Ceramic, SMD, 5%
7	9	C5 C11 C15 C19	Ceramic Capacitor	C1608X7R1E105K/885012206080	TDK/WE	1uF, 25v	603	Capacitor, Ceramic, 25v, 10%
8	1	C21	Ceramic Capacitor	C3216X7S2A225K	TDK	2.2uF, 100v	1206	Capacitor, Ceramic, 100V, 10%
9	1	C10	Ceramic Capacitor	CS65-B2GA221KYNKA	TDK	220pF, Y1	Lead type	HV Ceramic Capacitor, safety standard approved
10	1	C3	Ceramic Capacitor	C3216C0G2J331J	TDK	330pF, 630V	1206	Capacitor, Ceramic, Chip, 5%
11	2	C17 C18	Ceramic Capacitor	Std/8850120060809	std/WE	390pF	603	Capacitor, Ceramic, 50V, 10%
12	1	C4	Ceramic Capacitor	C2012X7R1E475K	TDK	4.7uF, 25v	805	Capacitor, Ceramic, 25V, 10%
13	1	C6	Ceramic Capacitor	Std/885012006055	std/WE	47pF	603	Capacitor, Ceramic, 50V, 10%
14	1	C25	Ceramic Capacitor	8.90334E+11	Wurth	683, X2	THT, 7.5mm, 10mmx6mm	HV Ceramic Capacitor, safety standard approved
15	1	U5	CCG3 USB-PD Type C controller	CYPD3135-40LQXIT	CYPRESS		QFN40	USB-PD Type C controller
16	1	J2	2.0mm SIP connector	std	std	NC	2.0mm	2.0mm SIP connector, NC
17	2	D1 D3	Bridge rectifier	MDB6S	ON (FSC)	1A, 600V	Micro-DIP	Bridge Rectifier, 600V, 1A
18	1	DNR	Varistor	820573011	Wurth	10D471K	lead	Varistor, 10D471K
19	7	D2 D7 D8 D10 D11	Switching diode	BAS21HT1G	ON	0.2A, 250V	SOD323	Switching diode, SMD
20	1	D6	Switching diode	GSD2004WS	Vishay	0.2A, 300V	SOD323	Switching diode, SMD
21	2	D4 D9	Schottky diode	BAT54HT1G	ON	0.2A, 30V	SOD323	Schottky diode, SMD
22	1	D5	Altrafast rectifier	US1JFA	ON (FSC)	0.8A, 600V	SOD123FL	Standard Rectifier, 0.8A, 600V
23	2	D12 D13	Standard rectifier	RS1JFA	ON (FSC)	0.8A, 600V	SOD123FL	Standard Rectifier, 0.8A, 600V
24	1	FB	Ferrite bead	UPZ2012E102-1R5TF	Sunlord/Wueth		805	1000ohm@100MHz
25	1	FB1	Ferrite bead	UPZ2012E601-2R0TF	Sunlord/Wueth		805	600ohm@100MHz
26	1	L1	Common filter	150-1327	Wurth-Midcon	500uH	TH type	T type, 6.3x3x3, dual wire, 10T
27	1	F1	Fuse	std	std	1.6A, 250Vac	Axial lead	Square Fuse, 1.6A/250V, 8.5mmx4mm
28	1	Q10	NPN Transistor	MMBT3904LT1G	ON	40V	SOT23	General NPN Transistor, SMD

DN05099/D
BOM (Continued)

Item	Qty	Reference	Type	Part Name	MFR	Value	Package	Description
29	4	Q3 Q4 Q7 Q8	NPN Transistor	MMBTA06LT1G	ON	80v	SOT23	General NPN Transistor, SMD
30	1	Q5	PNP Transistor	MMBT3906LT1	ON	40v	SOT23	GENERAL PURPOSE PNP SILICON TRANSISTOR
31	1	Q9	NPN transistor	MMBTA56LT1G	ON	80v	SOT23	GENERAL PURPOSE PNP SILICON TRANSISTOR
32	1	U3	Syn. rectified contr	NCP43080DDR2G	ON		S08	Syn. Rectified Controller
33	1	U2	QC3.0, CC/CV contro	NCP4371BBCDR2G	ON		S08	QC3.0 protocol and CC/CV controller
34	1	U1	PWM Controller	NCP1340B3D1R2G	ON		SOP9	PWM controller
35	1	Q6	MOSFET	NTTFS4932NTAG	ON		u8FL	MOSFET, NChan, 30V, 5ohm
36	1	NTC1	NTC	std	MuRata	13k	603	replaced by 13k,0603 resistor
37	1	NTC	NTC	SPNL07D2R5MBI	Sunlord	2.5ohm	lead type	7mm Die, 2.5ohm
38	1	U4	Optical coupler	EL1014-G	EL		SOP4	4pin long creepage SOP package
39	1	L2	Axial leaded fixed i	7447462101	Wurth	100uH		Axial leaded fixed inductor
40	1	R21	Resistor	Std	Std	0	603	Resistor, Chip, 1/8W, 1%,
41	1	R6	Resistor	Std	Std	1	603	Resistor, Chip, 1/8W, 1%
42	1	R24	Resistor	Std	Std	1.2k	603	Resistor, Chip, 1/8W, 1%
43	1	R16	Resistor	Std	Std	10	603	Resistor, Chip, 1/8W, 1%
44	2	R13 R15	Resistor	Std	Std	100K	603	Resistor, Chip, 1/8W, 1%
45	1	R36	Resistor	Std	Std	100k	603	Resistor, Chip, 1/8W, 1%
46	2	R19 R35	Resistor	Std	Std	10K	603	Resistor, Chip, 1/8W, 1%
47	1	R18	Resistor	Std	Std	10k	603	Resistor, Chip, 1/8W, 1%
48	1	R30	Resistor	Std	Std	10k	603	Resistor, Chip, 1/8W, 1%,
49	1	R37	Resistor	Std	Std	18K	603	Resistor, Chip, 1/8W, 1%
50	1	R17	Resistor	Std	Std	18k	603	Resistor, Chip, 1/8W, 1%
51	1	R22	Resistor	Std	Std	1K	603	Resistor, Chip, 1/8W, 1%,
52	1	R26	Resistor	Std	Std	1K	603	Resistor, Chip, 1/8W, 1%
53	1	R20	Resistor	Std	Std	1M	603	Resistor, Chip, 1/8W, 1%
54	1	R23	Resistor	Std	Std	4.7M	603	Resistor, Chip, 1/8W, 1%
55	2	R3 R10	Resistor	Std	Std	1k	603	Resistor, Chip, 1/8W, 1%
56	1	R7	Resistor	Std	Std	20k	603	Resistor, Chip, 1/8W, 1%
57	1	R11	Resistor	Std	Std	300	603	Resistor, Chip, 1/8W, 1%
58	1	R8	Resistor	Std	Std	30K	603	Resistor, Chip, 1/8W, 1%

DN05099/D
BOM (Continued)

Item	Qty	Reference	Type	Part Name	MFR	Value	Package	Description
59	1	R40	Resistor	Std	Std	39K	603	Resistor, Chip, 1/8W, 1%
60	1	R33	Resistor	Std	Std	39k	603	Resistor, Chip, 1/8W, 1%
61	1	R27	Resistor	Std	Std	3K	603	Resistor, Chip, 1/8W, 1%
62	1	R9	Resistor	Std	Std	3k	603	Resistor, Chip, 1/8W, 1%
63	1	R25	Resistor	Std	Std	4.3K	603	Resistor, Chip, 1/8W, 1%
64	1	R34	Resistor	Std	Std	4.7	603	Resistor, Chip, 1/8W, 1%
65	1	R38	Resistor	Std	Std	470k	603	Resistor, Chip, 1/8W, 1%
66	1	R32	Resistor	Std	Std	68K	603	Resistor, Chip, 1/8W, 1%
67	1	R41	Resistor	Std	Std	75k	603	Resistor, Chip, 1/8W, 1%
68	1	R28	Resistor	Std	Std	9.1k	603	Resistor, Chip, 1/8W, 1%
69	2	R4-5	Resistor	ERJ8BQFR51V	Panasonic	0.51	1206	Resistor, Chip, 1/2W, 1%
70	1	R2	Resistor	Std	Std	10	1206	Resistor, Chip, 1/4W, 1%
71	1	R29	Resistor	Std	Std	120	805	Resistor, Chip, 1/5W, 1%
72	1	R31	Resistor	Std	Std	1k	805	Resistor, Chip, 1/5W, 1%
73	1	R12	Resistor	Std	Std	20	805	Resistor, Chip, 1/5W, 1%
74	1	R1	Resistor	Std	Std	300k	1206	Resistor, Chip, 1/4W, 1%
75	1	R14	Resistor	ERJMP2KF7MOU	Panasonic	7mohm	1206	Resistor, Chip, 0.5W, 1%
76	1	T1	Transformer	750343412	WE-midcon		TH type	RM8 core, 6Pin bobbin, secondary flying wire
77	2	C1 C2	Electrolytic capacitor	KW series/ERK2GM33	CapXon/AiShi	33uF, 400V	13X16	size:13mmx16mm
78	2	C13 C14	Electrolytic solid capacitor	PS561M025F115P	CapXon	560uF, 25V	8mmx12mm	size:8mmx12mm
79	1	C29	Al Electrolytic capacitor	GF Series	CapXon	470uF, 25V	8mmx12mm	size:8mmx12mm
80	1	L	90 degree, signal connector	std	std		TH type	90度单根连接针, 用于输入AC端子
81	1	N	90 degree, signal connector	std	std		TH type	90度单根连接针, 用于输入AC端子
82	1	Q1	MOSFET	NTMFS6B03NT1G	ON		S08FL	MOSFET, NChan, 100V, 4.7mohm
83	1	Q2	MOSFET	IPL60R385CP	Infineon		THINKPAK-8X8	MOSFET, NChan, 600V, 380mohm
84	1	J1	USB Type C connector	632 723 300 011	Wueth		SMT/TH	Type C connector, SMT
85	2	ZD1 ZD5	Zener	MM3Z10VT1G	ON	10V	SOD323	GENERIC ZENER-DIODE
86	1	ZD2	Zener	MM3Z20VT1G	ON	20V	SOD323	GENERIC ZENER-DIODE
87	1	ZD3	Zener	MM3Z22VT1G	ON	22V	SOD323	GENERIC ZENER-DIODE

References

ON Semiconductor data sheet for NCP1340/43080/4371, NTMFS6B03, NTTFS4932N

ON Semiconductor Design Notes DN05043

Disclaimer: ON Semiconductor is providing this design note "AS IS" and does not assume any liability arising from its use; nor does ON Semiconductor convey any license to its or any third party's intellectual property rights. This document is provided only to assist customers in evaluation of the referenced circuit implementation and the recipient assumes all liability and risk associated with its use, including, but not limited to, compliance with all regulatory standards. ON Semiconductor may change any of its products at any time, without notice.

Design note created by; e-mail: david.dou@onsemi.com