

ON Semiconductor

Is Now

onsemi™

To learn more about onsemi™, please visit our website at
www.onsemi.com

onsemi and **onsemi** and other names, marks, and brands are registered and/or common law trademarks of Semiconductor Components Industries, LLC dba "**onsemi**" or its affiliates and/or subsidiaries in the United States and/or other countries. **onsemi** owns the rights to a number of patents, trademarks, copyrights, trade secrets, and other intellectual property. A listing of **onsemi** product/patent coverage may be accessed at www.onsemi.com/site/pdf/Patent-Marking.pdf. **onsemi** reserves the right to make changes at any time to any products or information herein, without notice. The information herein is provided "as-is" and **onsemi** makes no warranty, representation or guarantee regarding the accuracy of the information, product features, availability, functionality, or suitability of its products for any particular purpose, nor does **onsemi** assume any liability arising out of the application or use of any product or circuit, and specifically disclaims any and all liability, including without limitation special, consequential or incidental damages. Buyer is responsible for its products and applications using **onsemi** products, including compliance with all laws, regulations and safety requirements or standards, regardless of any support or applications information provided by **onsemi**. "Typical" parameters which may be provided in **onsemi** data sheets and/or specifications can and do vary in different applications and actual performance may vary over time. All operating parameters, including "Typicals" must be validated for each customer application by customer's technical experts. **onsemi** does not convey any license under any of its intellectual property rights nor the rights of others. **onsemi** products are not designed, intended, or authorized for use as a critical component in life support systems or any FDA Class 3 medical devices or medical devices with a same or similar classification in a foreign jurisdiction or any devices intended for implantation in the human body. Should Buyer purchase or use **onsemi** products for any such unintended or unauthorized application, Buyer shall indemnify and hold **onsemi** and its officers, employees, subsidiaries, affiliates, and distributors harmless against all claims, costs, damages, and expenses, and reasonable attorney fees arising out of, directly or indirectly, any claim of personal injury or death associated with such unintended or unauthorized use, even if such claim alleges that **onsemi** was negligent regarding the design or manufacture of the part. **onsemi** is an Equal Opportunity/Affirmative Action Employer. This literature is subject to all applicable copyright laws and is not for resale in any manner. Other names and brands may be claimed as the property of others.

Universal AC Input, 5.3 V 2 A Output, 10.6 W Charger Using NCP1365



ON Semiconductor®

www.onsemi.com

DESIGN NOTE

Table 1. DEVICE DETAILS

Device	Application	Input Voltage	Output Power	Topology	I/O Isolation
NCP1365BBCC	Mobile, Tablet, Charger, Adapter	90 to 264 Vac	10.6 W	Quasi Resonant Flyback	Yes

Item	Output Specification	Test Condition
Rated Input Voltage	100 ~ 240 Vac	–
Input Voltage Range	90 ~ 264 Vac	–
Input Frequency Range	47 ~ 63 Hz	–
Inrush Current	< 30 A	264 Vac and 2 A Load
Average Efficiency	> 82%	Measured at Board End
Average Efficiency at Cable End	> 78%	Measured at Cable End
Standby Power	< 30 mW	90 ~ 264 Vac
Output Voltage	5 ~ 5.5 V, 5.3 V at 2 A	90 ~ 264 Vac and 0 ~ 2 A
Output Current	2 A	90 ~ 264 Vac
Rated Output Power	> 10.6 W	90 ~ 264 Vac
Ripple and Noise	< 120 mV	90 ~ 264 Vac, 1 μ F + 0.1 μ F CAP@E-load
Rise Time	< 30 ms	At No/Full Load, 115 Vac & 230 Vac
Start-up Time	< 1.5 s	90 ~ 264 Vac and 0 ~ 2 A
Over Shoot	< 6.4 V	At 1 m USB Cable End
Transient Response	4.5 ~ 5.5 V	0.1–1.9 A, 0.25 A/ μ s, 10 ms Cycle

Circuit Description

This design note describes a 10.6 W, universal AC input, isolated Quasi-Resonant flyback converter for smart phone, tablet charger and smart socket power supply etc.

The featured power supply is a primary side constant voltage and current regulation utilizing ON Semiconductor's new NCP1365 current mode controller which is in SO8 package. This design note provides the complete circuit schematic details, layout, test data and BOM for 5.3 V, 2 A power supply.

1. Input Circuit:

Rectifier, filter and EMC circuit formed by D1, C1, C1, L1, NTC is 2.5 Ω negative temperature coefficient resistor to provide inrush protection, FR1 provides short-circuit protection when large AC input current occurs.

2. NCP1365 Control Circuit:

NCP1365 integrates a high voltage start-up current source, so pin 8 can be connected to high voltage rail directly or via a resistor. R8, and R9 consists of voltage simple network to set output voltage, C12 is a delayed capacitor to delay switching on to valley.

R12 and R13 is a current sensing resistor to decide how much current can be set, R10 and CS pin parasitic capacitor consists of a filter to filter current spike. R19, C11 and C9 consist of a type II compensation network to provide voltage feedback control loop compensation.

R4, D6 and C4 consist of V_{CC} supply circuit, R4 can adjust V_{CC} voltage and also prevent D6 from an inrush current. An RCD–R clamp consisting of

D5, R3, R6, and C7 limits drain voltage spikes caused by leakage inductance, resistor R6 has a relatively large value to prevent any excessive ringing on the drain voltage waveform and R3 can limit the reverse recovery current through D5.

3. Output Rectification and Filter:

The transformer (T1) secondary is rectified by D2, a Schottky barrier-type diode (chosen for higher efficiency), and filtered by C3, C5 and C8. In this application, C3 and C5 have sufficiently low ESR characteristics to allow meeting the output voltage ripple requirement without adding an LC post filter. C6 and R7 are snubber network of D2 to eliminate excessive ringing on secondary voltage waveform. R14 is a dummy load to prevent output voltage rising at no load.

Key Features

- Primary Side Regulation (PSR) CC/CV Control
- Quasi-Resonant Current Mode Control with Valley Switching
- Valley Lockout Avoids Audible Noise at Valley Jumping Operation
- Integrated 560 V High Voltage Start-up Current Source
- Built in 4 ms Soft Start
- 110 kHz Maximum Clamp Frequency Operation
- Adjustable Voltage Control Loop Compensation
- 300 mV Cable Drop Compensation
- Wide Operation V_{CC} Range (Up to 30 V)
- Cycle by Cycle Current Limit
- Built in V_{CC} OVP (Typical 26 V)
- Built in Output UVP in CC Mode ($3\text{ V} \pm 6.7\%$)
- Output OCP, SCP, OVP and Controller OTP Function
- CS Pin Open and Short Protection
- V_s Pin Open and Short Protection
- Meet COC V5 Tier 2
- 100 pF Y Capacitor
- “Travel Adapter” (TA) Form Factor
- Size: $47 \times 34 \times 15\text{ mm}$

PCB Layout

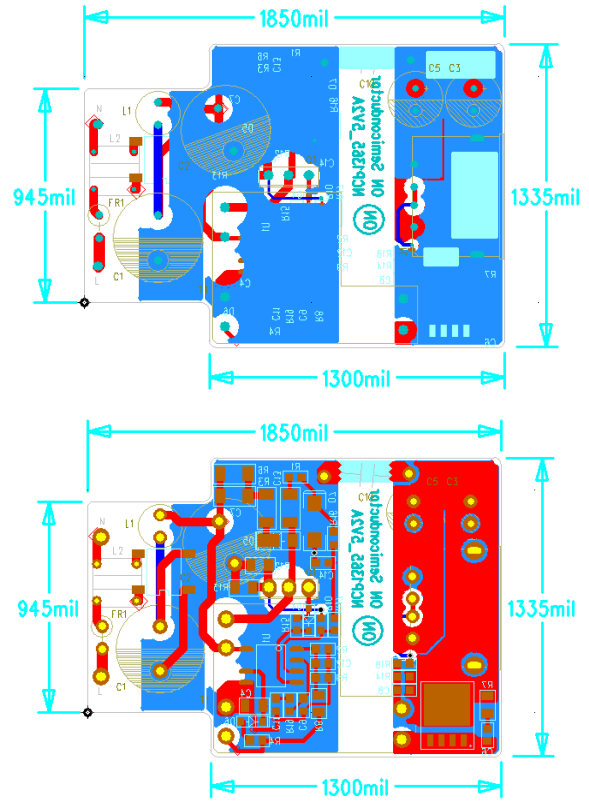

Figure 1. PCB Layout

Demoboard Photo

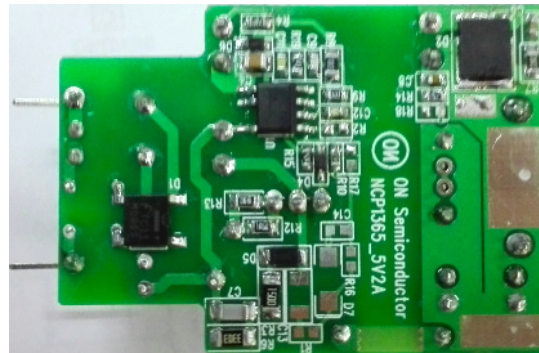
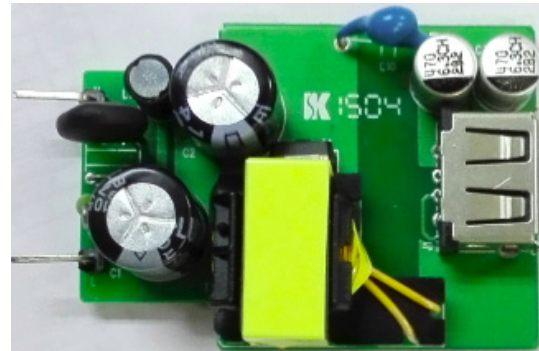

Figure 2. Demoboard Photo

Circuit Schematic

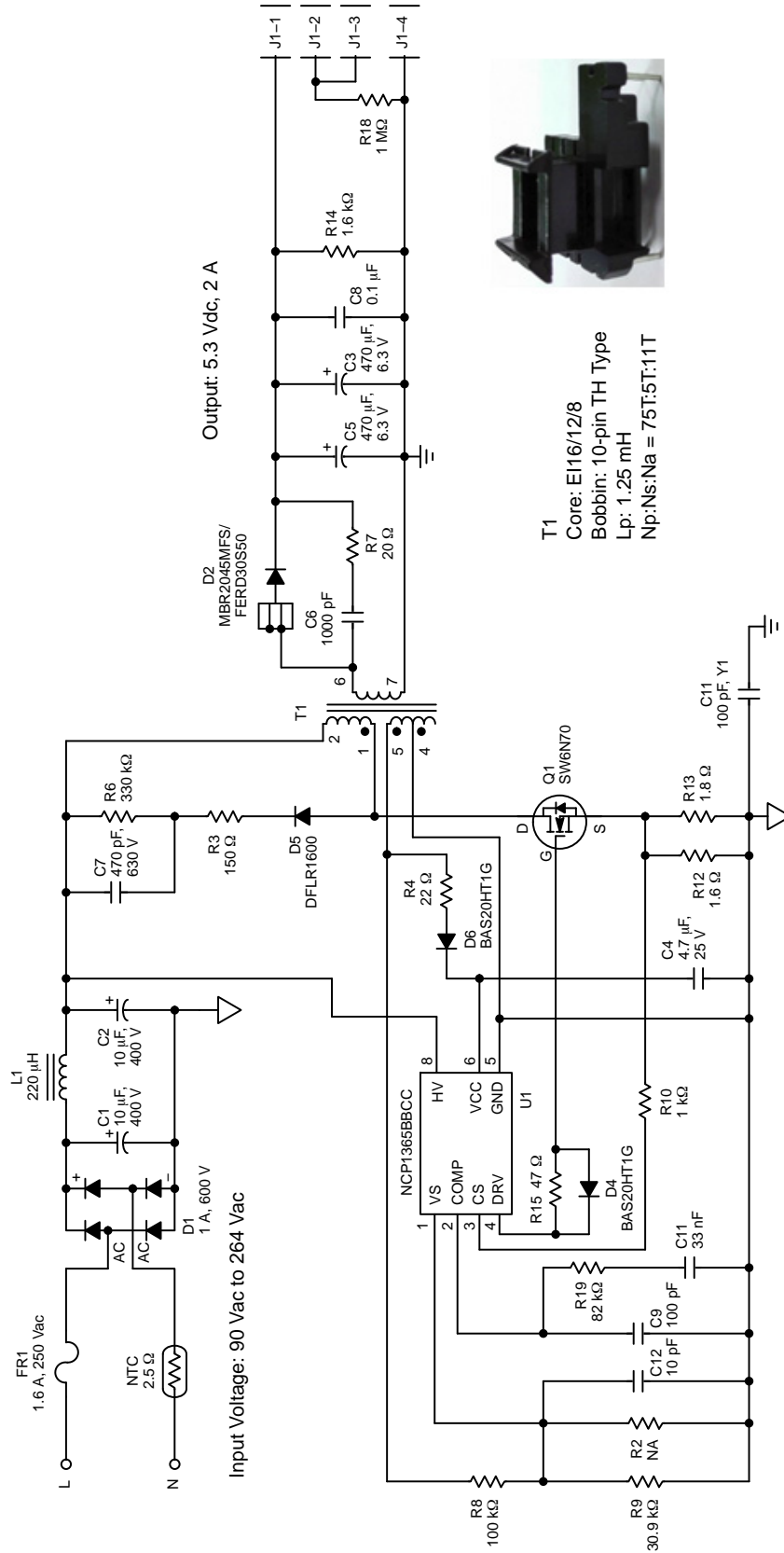

Figure 3. Circuit Schematic

DN05074/D

Standby Power at No Load

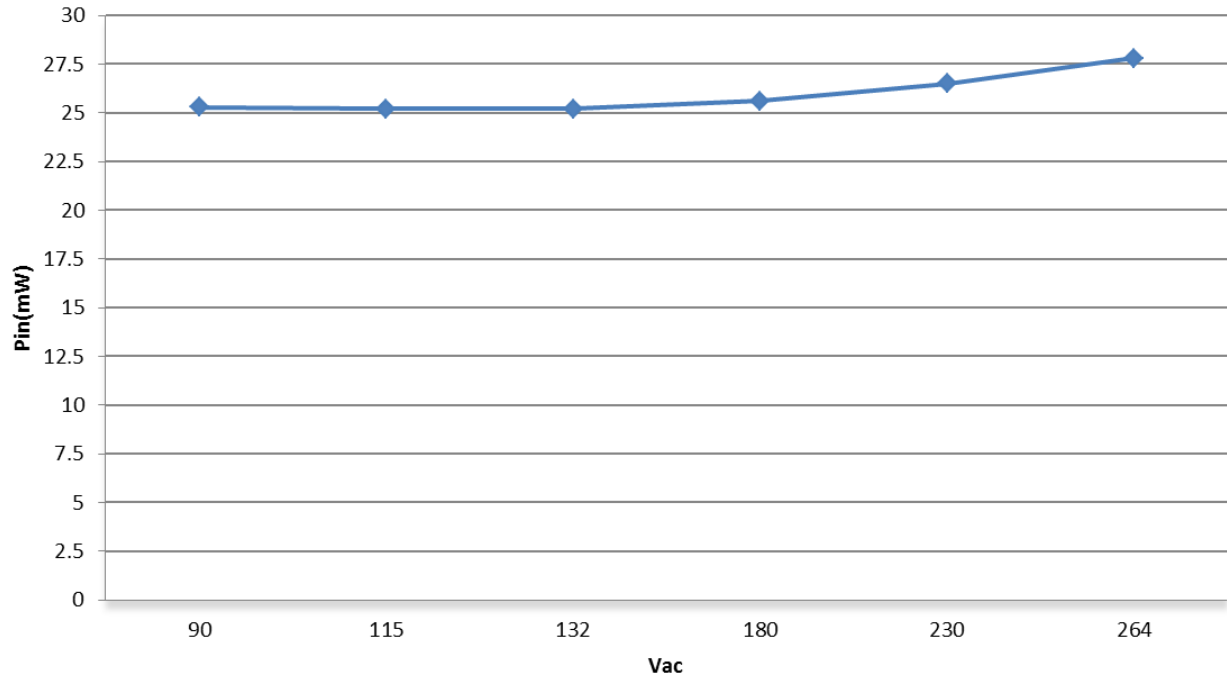

Figure 4. Standby Power at No Load

Average Efficiency between 25%, 50%, 75% and 100% Load

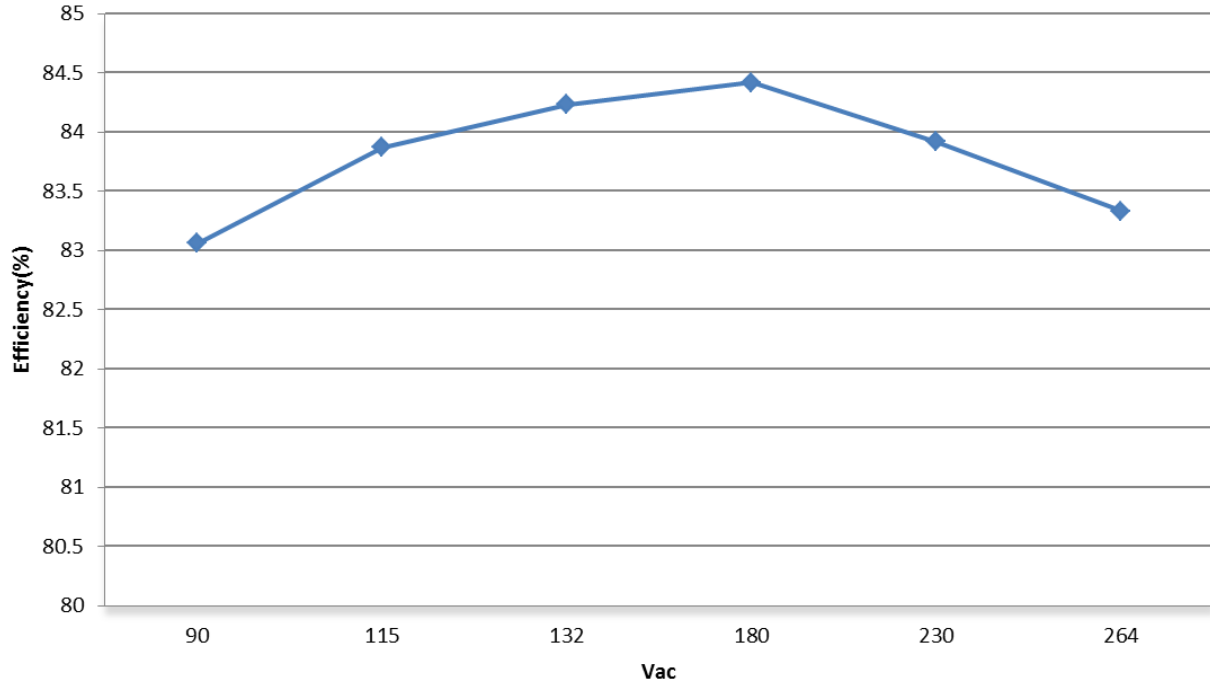

Figure 5. Average Efficiency between 25%, 50%, 75% and 100% Load

Efficiency vs. Load Curves

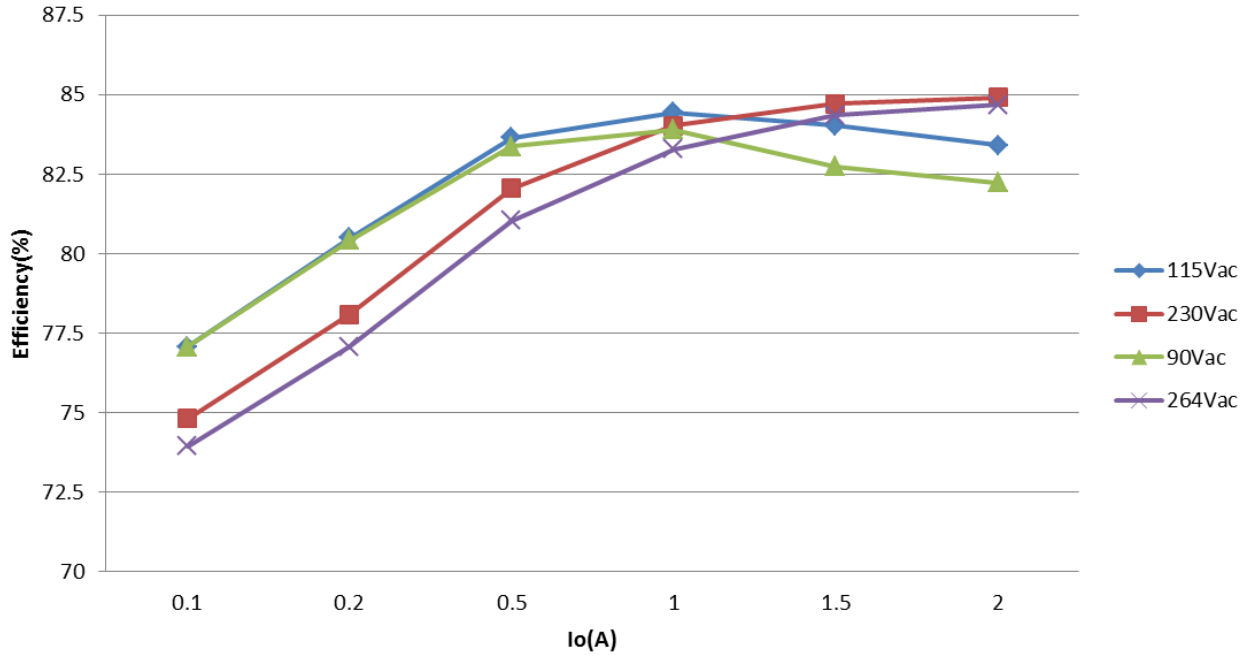

Figure 6. Efficiency vs. Load Curves

I-V Curves

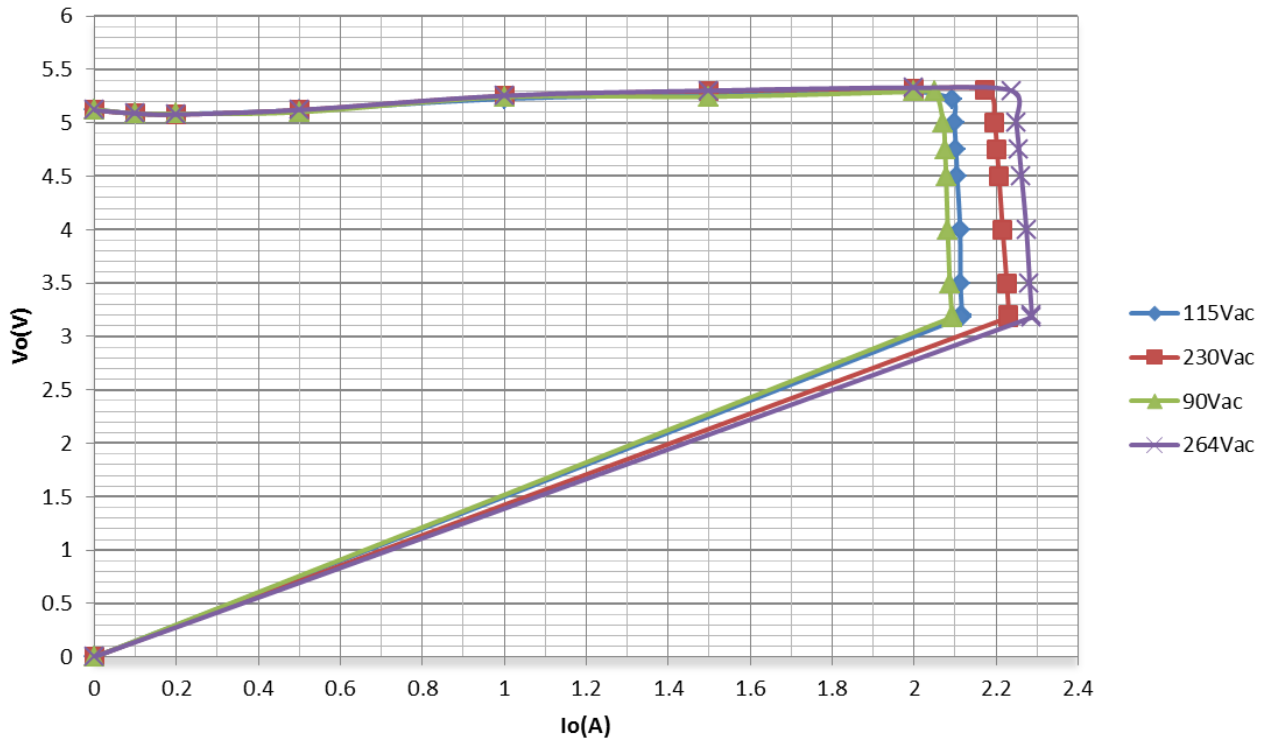

Figure 7. I-V Curves

OUTPUT RIPPLE VOLTAGE

(Test Condition: Tested at E-load with 1 m Cable, 1 μ F E-CAP and 0.1 μ F Ceramic in Parallel)

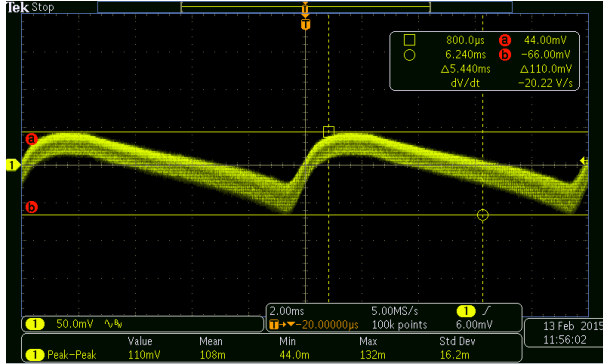

Figure 8. 90 Vac and 2 A Load

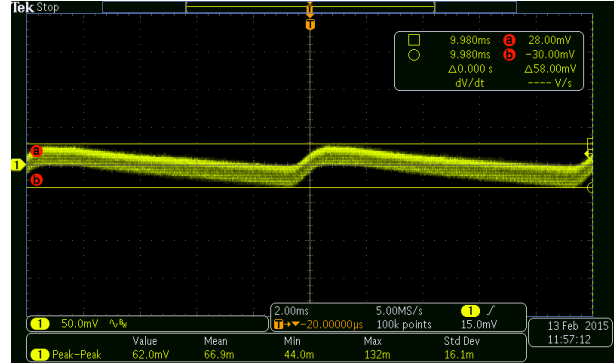

Figure 9. 115 Vac and 2 A Load

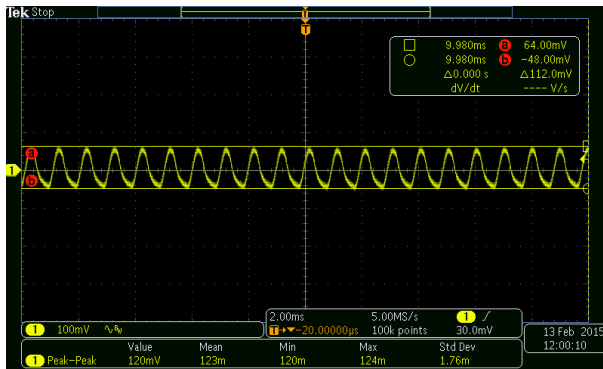

Figure 10. 230 Vac and 0.5 A Load

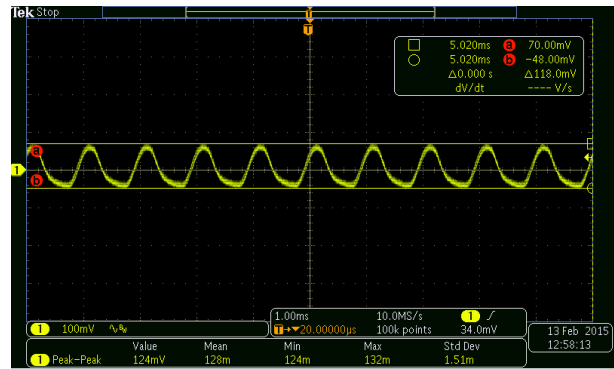

Figure 11. 264 Vac and 0.5 A Load

TRANSIENT RESPONSE

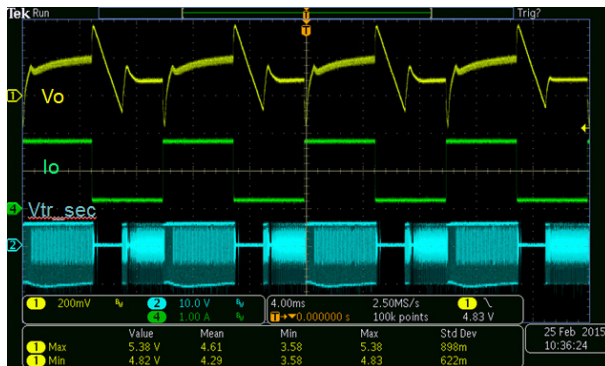

Figure 12. Test Condition: 0.2–1.8 A, 250 mA/ μ s, 10 ms Cycle, 115 Vac

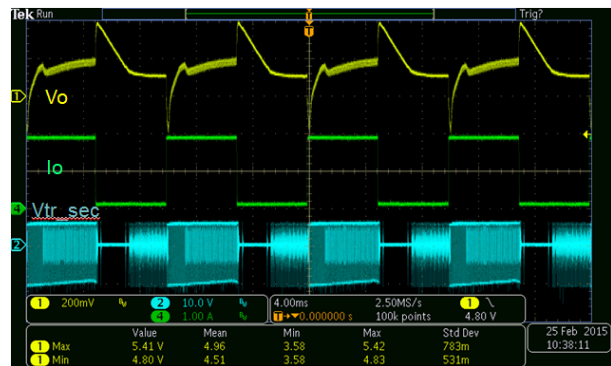

Figure 13. Test Condition: 0.1–1.9 A, 250 mA/ μ s, 10 ms Cycle, 115 Vac

OVP AND SCP

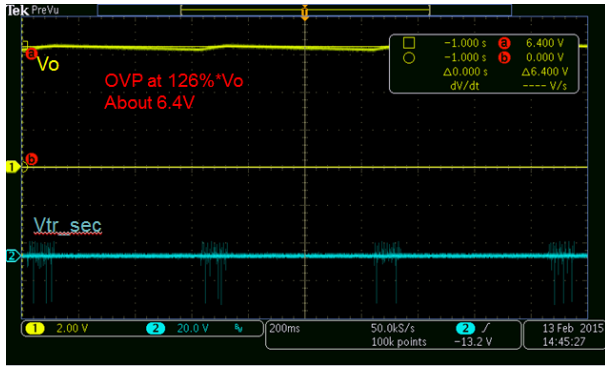

Figure 14. Test Condition: 264 Vac, No Dummy Load

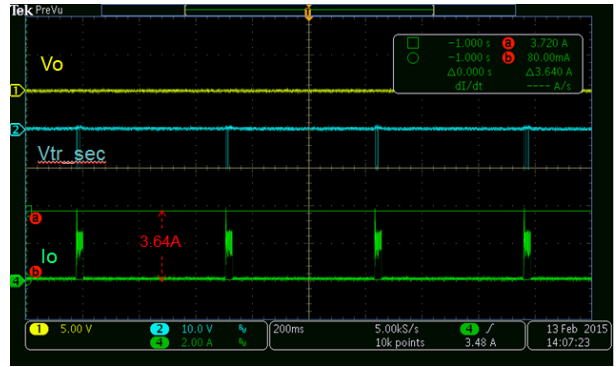

Figure 15. Test Condition: SC at Board End

START-UP TIME

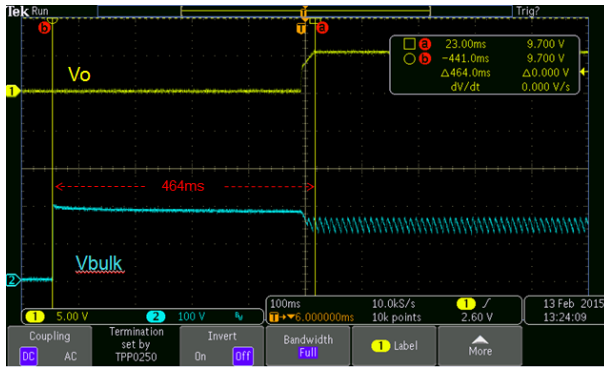

Figure 16. 90 Vac and 2 A CC Load

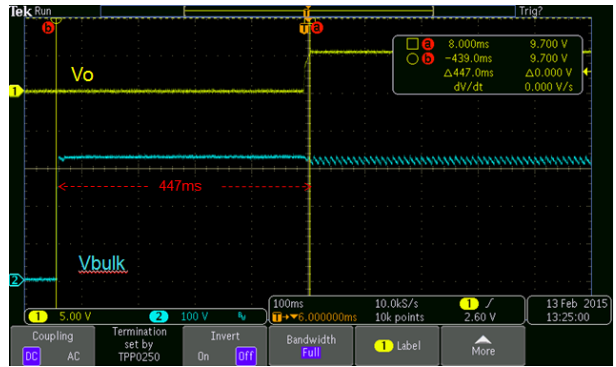

Figure 17. 230 Vac and 2 A CC Load

OUTPUT VOLTAGE RISE TIME

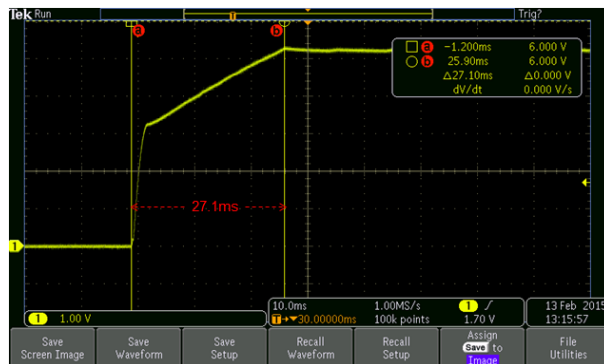

Figure 18. 115 Vac and 2 A CC Load

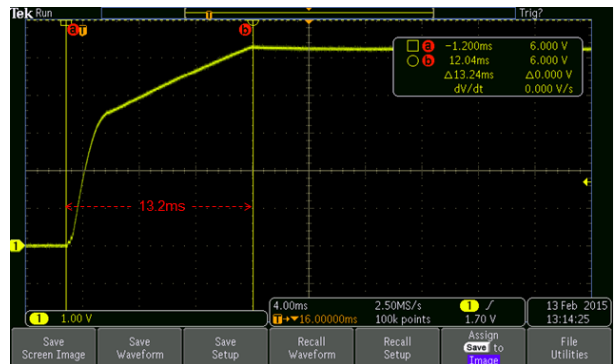

Figure 19. 230 Vac and 2 A CC Load

OUTPUT VOLTAGE OVERSHOOT

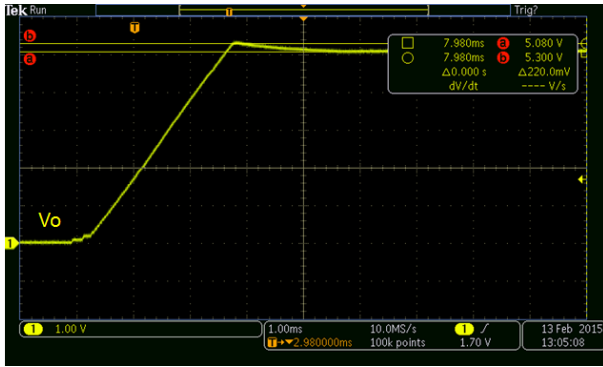

Figure 20. 115 Vac and No Load

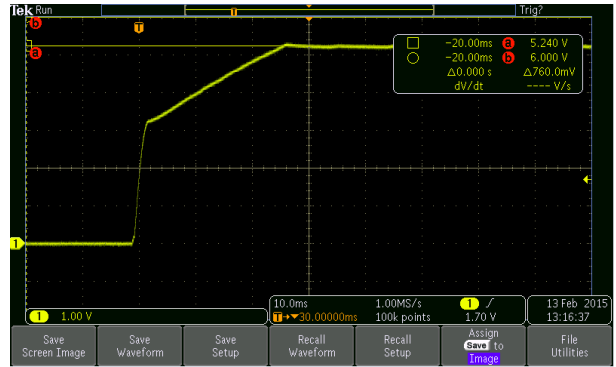

Figure 21. 115 Vac and 2 A CC Load

MOSFET DRAIN VOLTAGE

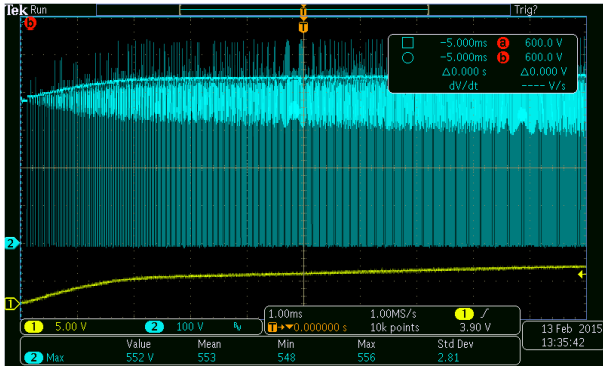

Figure 22. Start-up at 264 Vac and 2 A CC Load

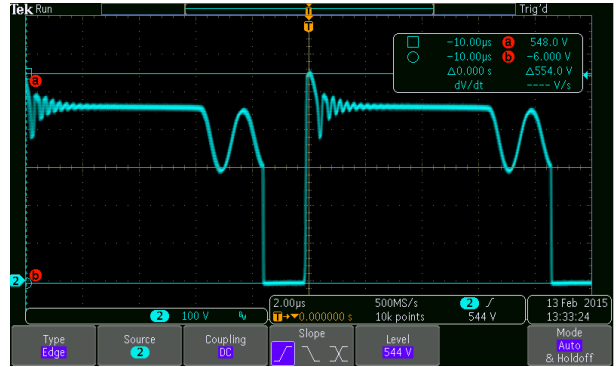

Figure 23. Working at 264 Vac and 2 A CC Load

INRUSH CURRENT

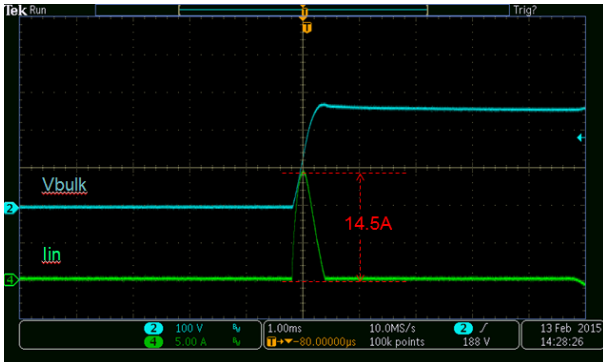

Figure 24. 264 Vac and 2 A CC Load

SECONDARY DIODE REVERSE VOLTAGE

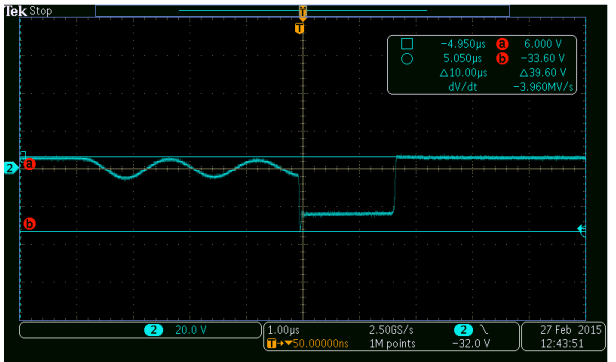
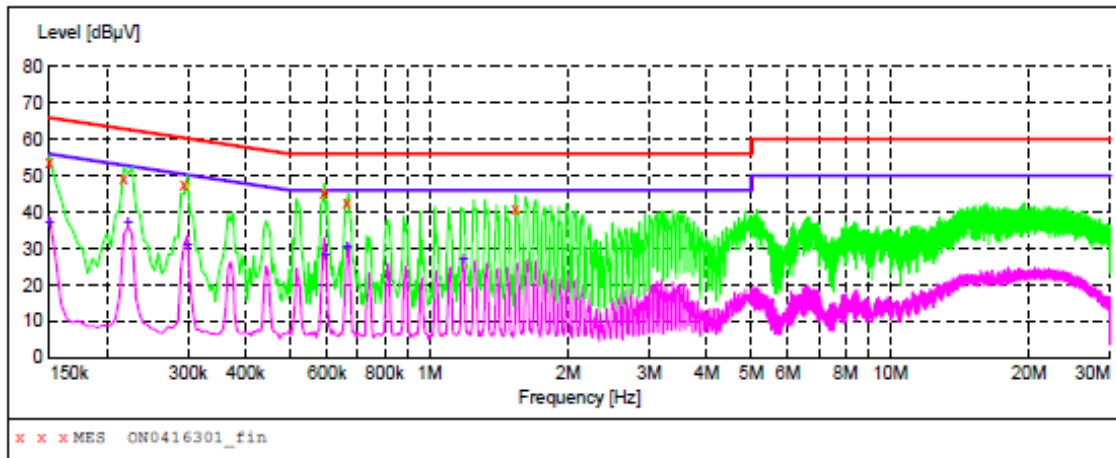

Figure 25. 264 Vac and 2 A CC Load

EMI TEST-CONDUCTION EMISSION



MEASUREMENT RESULT: "ON0416301_fin"

4/16/2015 4:10PM

Frequency MHz	Level dBµV	Transd dB	Limit dBµV	Margin dB	Detector	Line	PE
0.150000	53.60	10.2	66	12.4	QP	L1	GND
0.217500	49.50	10.0	63	13.4	QP	L1	GND
0.294000	47.70	10.0	60	12.7	QP	L1	GND
0.591000	45.50	10.0	56	10.5	QP	L1	GND
0.663000	42.50	10.0	56	13.5	QP	L1	GND
1.540500	41.00	10.2	56	15.0	QP	L1	GND

MEASUREMENT RESULT: "ON0416301_fin2"

4/16/2015 4:10PM

Frequency MHz	Level dBµV	Transd dB	Limit dBµV	Margin dB	Detector	Line	PE
0.150000	37.40	10.2	56	18.6	AV	L1	GND
0.222000	37.40	10.0	53	15.3	AV	L1	GND
0.298500	31.60	10.0	50	18.7	AV	L1	GND
0.598500	28.60	10.0	46	17.4	AV	L1	GND
0.663000	30.80	10.0	46	15.2	AV	L1	GND
1.185000	27.80	10.2	46	18.2	AV	L1	GND

Figure 26. Test Condition: 230 Vac, Line, 1 m Cable and 2.5 Ω Resistor

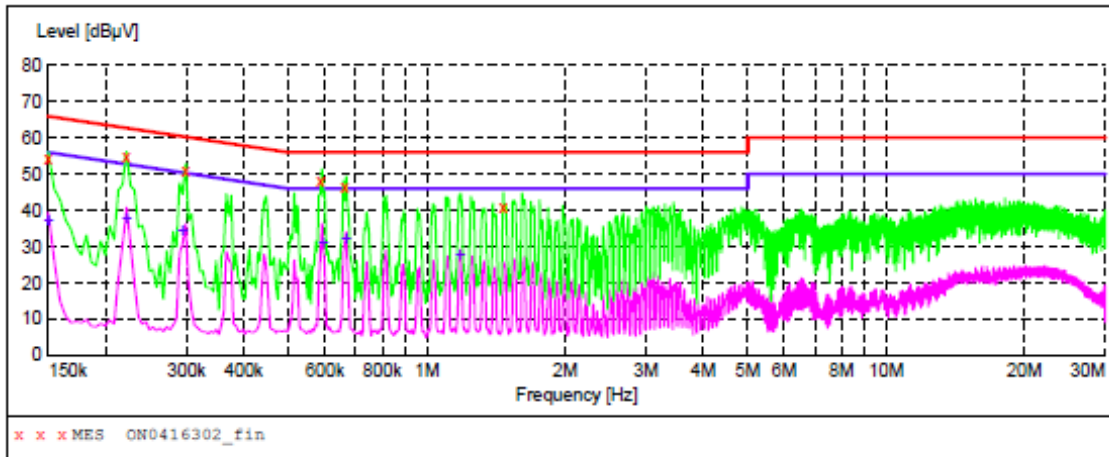

MEASUREMENT RESULT: "ON0416302_fin"

4/16/2015 4:13PM

Frequency MHz	Level dBµV	Transd dB	Limit dBµV	Margin dB	Detector	Line	PE
0.150000	54.50	10.2	66	11.5	QP	N	GND
0.222000	55.10	10.0	63	7.6	QP	N	GND
0.298500	50.70	10.0	60	9.6	QP	N	GND
0.586500	48.40	10.0	56	7.6	QP	N	GND
0.663000	46.60	10.0	56	9.4	QP	N	GND
1.468500	41.00	10.2	56	15.0	QP	N	GND

MEASUREMENT RESULT: "ON0416302_fin2"

4/16/2015 4:13PM

Frequency MHz	Level dBµV	Transd dB	Limit dBµV	Margin dB	Detector	Line	PE
0.150000	37.60	10.2	56	18.4	AV	N	GND
0.222000	38.40	10.0	53	14.3	AV	N	GND
0.294000	34.80	10.0	50	15.6	AV	N	GND
0.595500	31.20	10.0	46	14.8	AV	N	GND
0.667500	32.70	10.0	46	13.3	AV	N	GND
1.180500	28.30	10.2	46	17.7	AV	N	GND

Figure 27. Test Condition 230 Vac, Natural, 1 m Cable and 2.5 Ω Resistor

DN05074/D

Bill of Material

Table 2. BILL OF MATERIAL

Items	Qty	Reference	Type	Part Number	Manufacturer	Value	Package	Description
1	1	C8	Ceramic	Std	Std	0.1 μ F, 50 V	603	Capacitor, Ceramic, 10%
2	1	C6	Ceramic	Std	Std	1000 pF, 50V	603	Capacitor, Ceramic, 10%
3	1	C9	Ceramic	Std	Std	100 pF, 50 V	603	Capacitor, Ceramic, 10%
4	1	C10	Ceramic Capacitor	CS65-B2GA101KYNKA	TDK	100 pF, Y1	Lead Type	Safety Standard Approved, 10%
5	1	C12	Ceramic	Std	Std	10 pF, 50 V	603	Capacitor, Ceramic, 10%
6	1	C11	Ceramic	Std	Std	33 nF, 50 V	603	Capacitor, Ceramic, 10%
7	1	C4	Ceramic	C2012X7R1E475K	TDK	4.7 μ F, 25 V	805	Capacitor, Ceramic, Chip, 10%
8	1	C7	Ceramic	C3216C0G2J471J	TDK	470 pF, 630 V	1206	Capacitor, Ceramic, Chip, 5%
9	1	D1	Bridge Rectifier	LMB6S	FSC/Others	1 A, 600 V	Micro-DIP	Bridge Rectifier, 600 V, 1 A
10	1	D2	Schottky Rectifier	MBR2045MFS/FERD30S50	ON/ST	20 A, 45 V	SO8FL	Schottky, 20 A, 45 V/30 A, 50 V
11	1	D5	Standard Rectifier	DFLR1600	Diodes	1 A, 600 V	POWERDI123	Standard Rectifier, 1 A, 600 V
12	2	D4 D6	Switching Diode	BAS20HT1G	ON Semiconductor	0.2 A, 200 V	SOD323	Switching Diode, SMD
13	1	T1	Transformer	EI16/12/8	Customized Transformer		TH Type	EI16/12/8, 10-pin Bobbin
14	1	FR1	Micro Fuse	20T-016H	Holly Fuse	1.6 A, 250 Vac	Axial Lead	Micro fuse, 1.6 A, 250 V
15	1	U1	PSR Controller	NCP1365BBCC	ON Semiconductor		SO8	PSR Controller with HV Start-up Source, SO8
16	1	Q1	NMOSFET	SW6N70	SAMWIN	6 A, 700 V	IPAK	NMOS, 6 A, 600 V, IPAK
17	1	NTC	NTC	SPNL07D2R5MBI	Sunlord	2.5 Ω	Lead Type	NTC, 2.5 Ω , 3 A
18	1	L1	Axial Leaded Fixed Inductor	7447462221	Würth	220 μ H		Axial Leaded Fixed Inductor
19	1	R8	Resistor	Std	Std	100 k Ω	805	Resistor, Chip, 1/5 W, 1%
20	1	R10	Resistor	Std	Std	1 k Ω	603	Resistor, Chip, 1/8 W, 1%
21	1	R4	Resistor	Std	Std	22 Ω	603	Resistor, Chip, 1/8 W, 1%
22	1	R9	Resistor	Std	Std	30.9 k Ω	603	Resistor, Chip, 1/8 W, 1%
23	1	R15	Resistor	Std	Std	47 Ω	603	Resistor, Chip, 1/8 W, 1%
24	1	R19	Resistor	Std	Std	82 k Ω	603	Resistor, Chip, 1/8 W, 1%
25	1	R2	Resistor	Std	Std	NA	603	Resistor, Chip, 1/8 W, 1%,
26	1	R12	Resistor	Std	Std	1.6 Ω	805	Resistor, Chip, 1/5 W, 1%
27	1	R13	Resistor	Std	Std	1.8 Ω	805	Resistor, Chip, 1/5 W, 1%
28	1	R3	Resistor	Std	Std	150 Ω	1206	Resistor, Chip, 1/4 W, 1%
29	1	R7	Resistor	Std	Std	20 Ω	805	Resistor, Chip, 1/5 W, 1%
30	1	R6	Resistor	Std	Std	330 k Ω	1206	Resistor, Chip, 1/4 W, 1%

DN05074/D

Table 2. BILL OF MATERIAL (continued)

Items	Qty	Reference	Type	Part Number	Manufacturer	Value	Package	Description
31	1	R14	Resistor	Std	Std	1.6 kΩ	603	Resistor, Chip, 1/8 W, 1%
32	1	R18	Resistor	Std	Std	1 MΩ	603	Resistor, Chip, 1/8 W, 1%
33	2	C1-2	Electrolytic Capacitor	AX/KSH106M400T1Z5H1CK	Rubycon/TEAPO	10 μF, 400 V	10 mm (Die.) × 12.5 mm (Height)	Size, 10 × 12.5 mm
34	2	C3 C5	Electrolytic Solid Capacitor	PCH477M6R3S1AGE08K	TEAPO	470 μF, 6.3 V	6.3 mm (Die.) × 8 mm (Height)	Size, 6.3 × 8 mm
35	1	J1	USB Connector		Std			USB Connector, Type A

References

- [1] DON Semiconductor datasheet for [NCP1360/5](#) CC/CV primary side PWM current mode controller.

ON Semiconductor and  are trademarks of Semiconductor Components Industries, LLC dba ON Semiconductor or its subsidiaries in the United States and/or other countries. ON Semiconductor owns the rights to a number of patents, trademarks, copyrights, trade secrets, and other intellectual property. A listing of ON Semiconductor's product/patent coverage may be accessed at www.onsemi.com/site/pdf/Patent-Marketing.pdf. ON Semiconductor reserves the right to make changes without further notice to any products herein. ON Semiconductor makes no warranty, representation or guarantee regarding the suitability of its products for any particular purpose, nor does ON Semiconductor assume any liability arising out of the application or use of any product or circuit, and specifically disclaims any and all liability, including without limitation special, consequential or incidental damages. Buyer is responsible for its products and applications using ON Semiconductor products, including compliance with all laws, regulations and safety requirements or standards, regardless of any support or applications information provided by ON Semiconductor. "Typical" parameters which may be provided in ON Semiconductor data sheets and/or specifications can and do vary in different applications and actual performance may vary over time. All operating parameters, including "Typicals" must be validated for each customer application by customer's technical experts. ON Semiconductor does not convey any license under its patent rights nor the rights of others. ON Semiconductor products are not designed, intended, or authorized for use as a critical component in life support systems or any FDA Class 3 medical devices or medical devices with a same or similar classification in a foreign jurisdiction or any devices intended for implantation in the human body. Should Buyer purchase or use ON Semiconductor products for any such unintended or unauthorized application, Buyer shall indemnify and hold ON Semiconductor and its officers, employees, subsidiaries, affiliates, and distributors harmless against all claims, costs, damages, and expenses, and reasonable attorney fees arising out of, directly or indirectly, any claim of personal injury or death associated with such unintended or unauthorized use, even if such claim alleges that ON Semiconductor was negligent regarding the design or manufacture of the part. ON Semiconductor is an Equal Opportunity/Affirmative Action Employer. This literature is subject to all applicable copyright laws and is not for resale in any manner.

PUBLICATION ORDERING INFORMATION

LITERATURE FULFILLMENT:

Literature Distribution Center for ON Semiconductor
 19521 E. 32nd Pkwy, Aurora, Colorado 80011 USA
Phone: 303-675-2175 or 800-344-3860 Toll Free USA/Canada
Fax: 303-675-2176 or 800-344-3867 Toll Free USA/Canada
Email: orderlit@onsemi.com

N. American Technical Support: 800-282-9855 Toll Free
 USA/Canada
Europe, Middle East and Africa Technical Support:
 Phone: 421 33 790 2910
Japan Customer Focus Center
 Phone: 81-3-5817-1050

ON Semiconductor Website: www.onsemi.com
Order Literature: <http://www.onsemi.com/orderlit>
 For additional information, please contact your local Sales Representative