

ON Semiconductor

Is Now

onsemi™

To learn more about onsemi™, please visit our website at
www.onsemi.com

onsemi and **onsemi** and other names, marks, and brands are registered and/or common law trademarks of Semiconductor Components Industries, LLC dba "**onsemi**" or its affiliates and/or subsidiaries in the United States and/or other countries. **onsemi** owns the rights to a number of patents, trademarks, copyrights, trade secrets, and other intellectual property. A listing of **onsemi** product/patent coverage may be accessed at www.onsemi.com/site/pdf/Patent-Marking.pdf. **onsemi** reserves the right to make changes at any time to any products or information herein, without notice. The information herein is provided "as-is" and **onsemi** makes no warranty, representation or guarantee regarding the accuracy of the information, product features, availability, functionality, or suitability of its products for any particular purpose, nor does **onsemi** assume any liability arising out of the application or use of any product or circuit, and specifically disclaims any and all liability, including without limitation special, consequential or incidental damages. Buyer is responsible for its products and applications using **onsemi** products, including compliance with all laws, regulations and safety requirements or standards, regardless of any support or applications information provided by **onsemi**. "Typical" parameters which may be provided in **onsemi** data sheets and/or specifications can and do vary in different applications and actual performance may vary over time. All operating parameters, including "Typicals" must be validated for each customer application by customer's technical experts. **onsemi** does not convey any license under any of its intellectual property rights nor the rights of others. **onsemi** products are not designed, intended, or authorized for use as a critical component in life support systems or any FDA Class 3 medical devices or medical devices with a same or similar classification in a foreign jurisdiction or any devices intended for implantation in the human body. Should Buyer purchase or use **onsemi** products for any such unintended or unauthorized application, Buyer shall indemnify and hold **onsemi** and its officers, employees, subsidiaries, affiliates, and distributors harmless against all claims, costs, damages, and expenses, and reasonable attorney fees arising out of, directly or indirectly, any claim of personal injury or death associated with such unintended or unauthorized use, even if such claim alleges that **onsemi** was negligent regarding the design or manufacture of the part. **onsemi** is an Equal Opportunity/Affirmative Action Employer. This literature is subject to all applicable copyright laws and is not for resale in any manner. Other names and brands may be claimed as the property of others.



Universal AC Input, 12 V Output, 10 W E-meter Power Supply

DESIGN NOTE

Table 1. DEVICE DETAILS

Device	Application	Input Voltage	Output Power	Topology	I/O Isolation
NCP1075, NCP431	Smart Meters, Electric Meters, White Goods	85 to 300 Vac	5 to 10 W	Flyback	Isolated (3 kV)

Characteristic	Output Specification
Output Voltage	12 Vdc
Ripple	150 mV p/p @ Full Load
Nominal Current	800 mA
Max Current	1.0 A Maximum
Min Current	Zero

PFC (Yes/No)	No, (Pout < 25 W)
Efficiency	77% per Energy Star
Inrush Limiting/Fuse	Inrush Resistor (R1) & Fuse
Operating Temp. Range	0 to +50°C
Cooling Method/Supply Orientation	Convection
Signal Level Control	None

Circuit Description

This design note describes a simple, low power (10 W or less), universal AC input, constant voltage power supply intended for powering utility electric meters or similar industrial equipment or white goods where isolation from the AC mains is required and low cost and high efficiency is essential.

The featured power supply is a simple flyback topology utilizing ON Semiconductor's new NCP1075 SOT-223 monolithic switcher. This Design Note provides the complete circuit schematic details and transformer design for a 12 V, 800 mA amp power supply. Other output voltages from 3.3 Vdc up to 28 Vdc are easy to implement by modifying the values (or ratings) of a few of the secondary side output components and the flyback transformer's secondary winding (T1). The simple input EMI filter is adequate to pass Level B for FCC conducted EMI compliance and the NCP431 plus optocoupler feedback scheme provides for excellent line and load regulation along with high input-to-output isolation.

Performance characteristics for efficiency, output ripple, and internal MOSFET drain switching characteristics are shown in the figures and plots below. Enhanced input transient protection (lightning, etc.) can be accomplished with the addition of an appropriate TVS device across C2.

Key Features

- Universal AC Input Range (85–300 Vac).
- Input Filter (Pi-network) for Conducted EMI Attenuation and Input Transient Protection
- Very Low Standby (No Load) Power Consumption
- Frequency Foldback under Light Load and/or Over-current Conditions
- Secondary Circuit Easily Configured for Different Output Voltages
- Inherent Over-current, Over-voltage and Over-temperature Protection

CIRCUIT SCHEMATIC

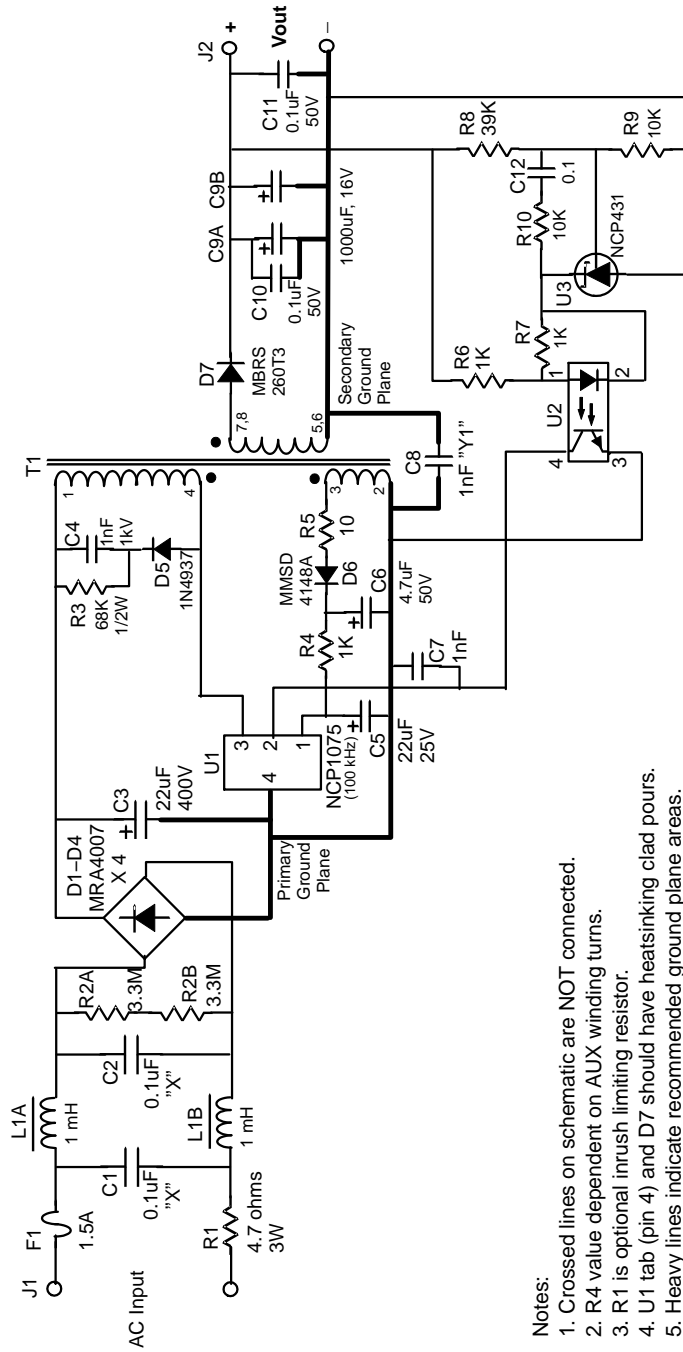

- Notes:
1. Crossed lines on schematic are NOT connected.
 2. R4 value dependent on AUX winding turns.
 3. R1 is optional inrush limiting resistor.
 4. U1 tab (pin 4) and D7 should have heatsinking clad pours.
 5. Heavy lines indicate recommended ground plane areas.
 6. L1A/L1B are Coilcraft RFB0810-102L.
 7. U2 is Vishay SFH6156A-4 optocoupler or similar.

10 W NCP1075 Power Supply with Universal AC Input

12 V Transformer Design

Project/Customer: ON Semiconductor – NCP1075 10W PSU
 Part Description: 10 W Flyback Transformer, 100 kHz, 12 V/0.8 A Out
 Schematic ID: T1
 Core Type: EF16 (E16/8/5); 3C90 Material or Similar
 Core Gap: Gap for 1.7 to 2 mH Inductance across Primary (Pins 1 – 4)
 Inductance: 1.85 mH \pm 5%
 Bobbin Type: 8 Pin Horizontal Mount for EF16

Windings (in order):

Winding #/Type	Turns/Material/Gauge/Insulation Data
Primary (4 – 1)	100 turns of #35HN over 2 layers evenly. Insulate with a layer of Mylar tape.
12 V Secondary (7, 8 – 5, 6)	10 turns of #24 triple insulated wire over one layer. Self leads to pins per drawing. Insulate with a layer of Mylar tape.
Vcc/Boost (3 – 2)	10 turns of #35HN spiral wound over 1 layer with 2 mm end margins. Insulate with tape for 3 kV.

Varnish assembly

Hipot: 3 kV from Vcc/primary to secondary.

Schematic

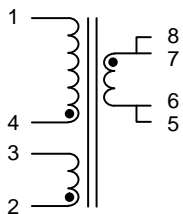

Lead Breakout/Pinout (Bottom View – Facing Pins)

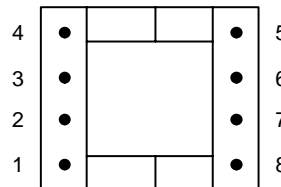

Note: Transformer is Wurth Electronics part #750312597

A 5 Vout version of this transformer is available on request.

DN05018/D

12 Vout Efficiency vs Load (NCP1075)

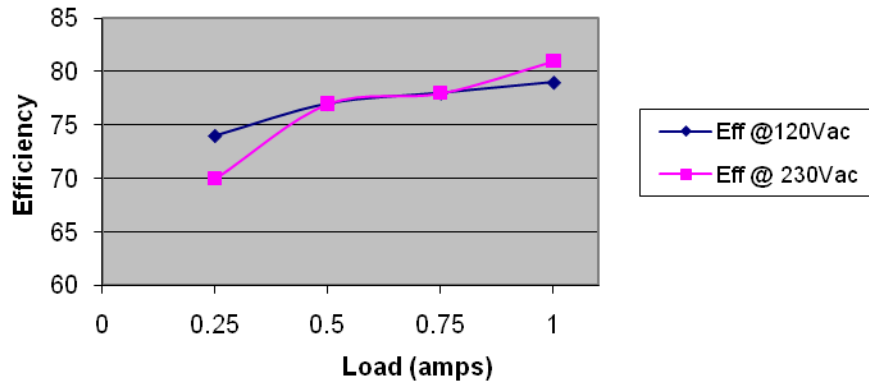

Average efficiency for both 120 Vac and 230 Vac was 77%.

Figure 1. Efficiency vs. Load Curves

Standby (No Load) Input Power

120 Vac: 74 mW
230 Vac: 107 mW

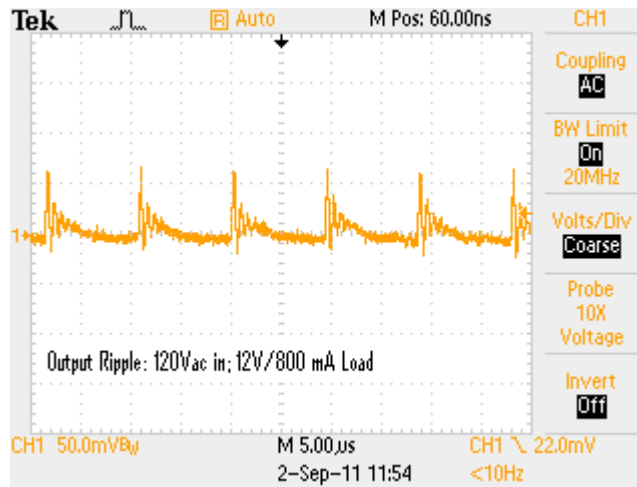

Figure 2. Full Load Output Ripple @ 120 Vac Input

DN05018/D

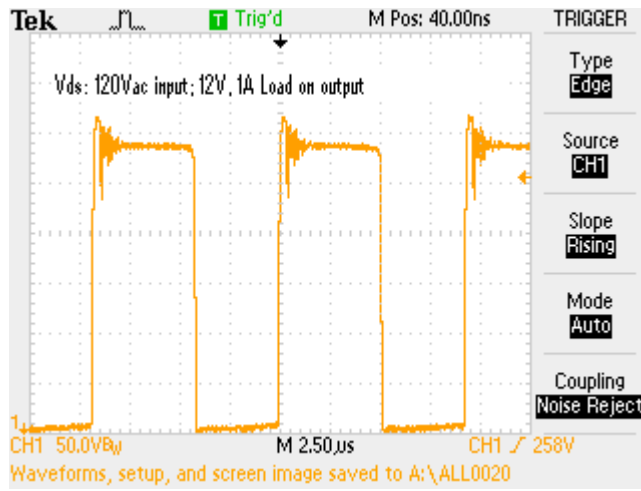

Figure 3. MOSFET Drain Voltage (120 Vac Input, 12 V, 1 A Load on Output)

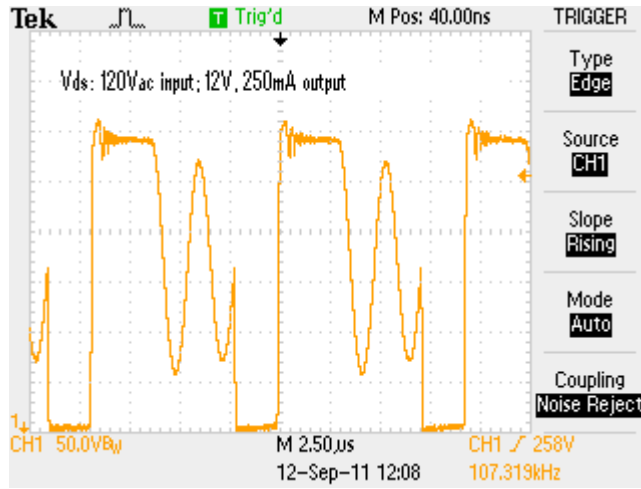
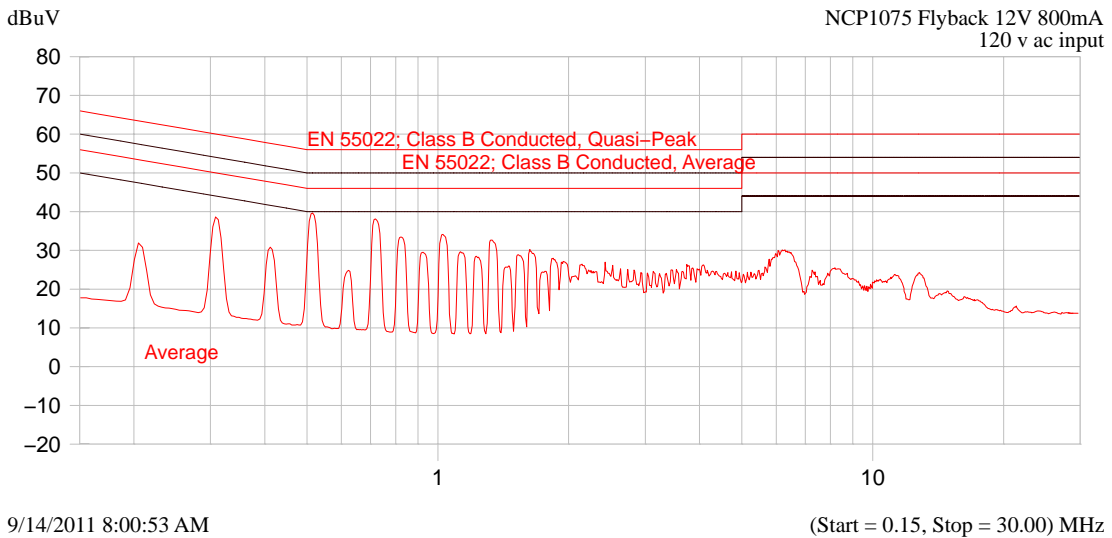

Figure 4. MOSFET Drain Voltage (120 Vac Input, 12 V, 250 mA Output)



9/14/2011 8:00:53 AM

(Start = 0.15, Stop = 30.00) MHz

Figure 5. EMI Profile

DN05018/D

BILL OF MATERIALS

Table 2. BILL OF MATERIALS FOR 12 Vout, 10 W NCP1075 FLYBACK

Designator	Qty	Description	Value	Tolerance	Footprint	Manufacturer	Manufacturer Part Number	Substitution Allowed
D7 (12 Vout)	1	Schottky Diode	2 A, 60 V		SMB	ON Semiconductor	MBRS260T3	No
D7 (5 Vout)	1	Schottky Diode	3 A, 40 V		SMB	ON Semiconductor	MBRS2040L	No
D1, D2, D3, D4	4	Diode – 60 Hz	1 A, 800 V		SMA	ON Semiconductor	MRA4007	No
D5	1	Diode – Fast Recov.	1 A, 600 V		Axial Lead	ON Semiconductor	1N4937	No
D6	1	Signal Diode	100 mA, 100 V		SOD-123	ON Semiconductor	MMSD4148A	No
U3	1	Programmable Zener	2.5 V		SOIC8/ SOT23	ON Semiconductor	NCP431A	No
U2	1	Optocoupler	CTR >= 0.5		4-pin	Vishay or NEC	SFH6156A-4 or PS2561L-1	Yes
U1	1	Switcher IC – NCP1075	100 kHz		SOT223	ON Semiconductor	NCP1075ST100	No
C1, C2	2	"X" Cap, Box Type	100 nF, X2		LS = 15 mm	Rifa, Wima	TBD	Yes
C8	1	"Y1" Cap, Disc Type	1 nF, Y1		LS = 7.5 mm	Rifa, Wima	TBD	Yes
C4	1	Ceramic Cap, Disc	1 nF, 1 kV	5%	LS = 7.5 mm	Rifa, Wima	TBD	Yes
C7	1	Ceramic Cap, Monolithic	1 nF, 50 V	10%	1206	AVX, Murata	TBD	Yes
C10, C11, C12	3	Ceramic Cap, Monolithic	100 nF, 50 V	10%	1206	AVX, Murata	TBD	Yes
C3	1	Electrolytic Cap	22 µF, 400/450 V	10%	LS = 7.5 mm, D = 16 mm	UCC, Panasonic	TBD	Yes
C6	1	Electrolytic Cap	4.7 µF, 50 Vdc	10%	LS = 2.5 mm, D = 6.3 mm	UCC, Panasonic	TBD	Yes
C5	1	Electrolytic Cap	22 µF, 25 V	10%	LS = 2.5 mm, D = 6.3 mm	UCC, Panasonic	TBD	Yes
C9A, C9B	2	Electrolytic Cap	1000 µF, 16 V	10%	LS = 5 mm, D = 12.5 mm	UCC, Panasonic	TBD	Yes
R1	1	Resistor, 3 W, Wire Wound	4.7 Ω, 3 W	10%	LS = 7.5 mm, D = 7 mm	Ohmite, Dale	TBD	Yes
R3	1	Resistor, 0.5 W, Metal Film	68 kΩ, 0.5 W	10%	Axial Lead; LS = 12.5 mm	Ohmite, Dale	TBD	Yes
R2A, R2B	2	Resistor, 1/4 W SMD	3.3 MΩ	5%	SMD 1206	AVX, Vishay, Dale	TBD	Yes
R5	1	Resistor, 1/4 W SMD	10 Ω	5%	SMD 1206	AVX, Vishay, Dale	TBD	Yes
R4	1	Resistor, 1/4 W SMD	1 kΩ	5%	SMD 1206	AVX, Vishay, Dale	TBD	Yes
R9, R10	2	Resistor, 1/4 W SMD	10 kΩ	1%	SMD 1206	AVX, Vishay, Dale	TBD	Yes
R7	1	Resistor, 1/4 W SMD	1 kΩ	1%	SMD 1206	AVX, Vishay, Dale	TBD	Yes
R6 (12 Vout)	1	Resistor, 1/4 W SMD	1 kΩ	1%	SMD 1206	AVX, Vishay, Dale	TBD	Yes
R6 (5 Vout)	1	Resistor, 1/4 W SMD	240 Ω	1%	SMD 1206	AVX, Vishay, Dale	TBD	Yes
R8 (12 Vout)	1	Resistor, 1/4 W SMD	39 kΩ	5%	SMD 1206	AVX, Vishay, Dale	TBD	Yes
R8 (5 Vout)	1	Resistor, 1/4 W SMD	10 kΩ	1%	SMD 1206	AVX, Vishay, Dale	TBD	Yes
F1	1	Fuse, TR-5 Style	1.5 A		TR-5, LS = 5 mm	Minifuse		Yes
L1A/B	2	Inductor (EMI Choke)	1 mH, 500 mA		See Wurth Drawing	LS = 5 mm, D = 8 mm	7447728102	Yes
T1 (12 Vout)	1	Transformer	E20/10/6 Core		See Mag Drawing	Würth Magnetics		Yes
J1, J2	2	Screw Terminal			LS = 0.2"	DigiKey	# 281-1435-ND	Yes

NOTE: Grey indicates part change with Vout change.

DN05018/D

REFERENCES

- [1] ON Semiconductor Data Sheet for [NCP1251/D](#) Controller in TSOP6 Package.
- [2] ON Semiconductor Design Notes [DN05012/D](#), [DN05014/D](#), [DN05017/D](#).
- [3] ON Semiconductor Application Note [AND8489/D](#)

ON Semiconductor and the  are registered trademarks of Semiconductor Components Industries, LLC (SCILLC) or its subsidiaries in the United States and/or other countries. SCILLC owns the rights to a number of patents, trademarks, copyrights, trade secrets, and other intellectual property. A listing of SCILLC's product/patent coverage may be accessed at www.onsemi.com/site/pdf/Patent-Marking.pdf. SCILLC reserves the right to make changes without further notice to any products herein. SCILLC makes no warranty, representation or guarantee regarding the suitability of its products for any particular purpose, nor does SCILLC assume any liability arising out of the application or use of any product or circuit, and specifically disclaims any and all liability, including without limitation special, consequential or incidental damages. "Typical" parameters which may be provided in SCILLC data sheets and/or specifications can and do vary in different applications and actual performance may vary over time. All operating parameters, including "Typicals" must be validated for each customer application by customer's technical experts. SCILLC does not convey any license under its patent rights nor the rights of others. SCILLC products are not designed, intended, or authorized for use as components in systems intended for surgical implant into the body, or other applications intended to support or sustain life, or for any other application in which the failure of the SCILLC product could create a situation where personal injury or death may occur. Should Buyer purchase or use SCILLC products for any such unintended or unauthorized application, Buyer shall indemnify and hold SCILLC and its officers, employees, subsidiaries, affiliates, and distributors harmless against all claims, costs, damages, and expenses, and reasonable attorney fees arising out of, directly or indirectly, any claim of personal injury or death associated with such unintended or unauthorized use, even if such claim alleges that SCILLC was negligent regarding the design or manufacture of the part. SCILLC is an Equal Opportunity/Affirmative Action Employer. This literature is subject to all applicable copyright laws and is not for resale in any manner.

PUBLICATION ORDERING INFORMATION

LITERATURE FULFILLMENT:

Literature Distribution Center for ON Semiconductor
P.O. Box 5163, Denver, Colorado 80217 USA
Phone: 303-675-2175 or 800-344-3860 Toll Free USA/Canada
Fax: 303-675-2176 or 800-344-3867 Toll Free USA/Canada
Email: orderlit@onsemi.com

N. American Technical Support: 800-282-9855 Toll Free
USA/Canada
Europe, Middle East and Africa Technical Support:
Phone: 421 33 790 2910
Japan Customer Focus Center
Phone: 81-3-5817-1050

ON Semiconductor Website: www.onsemi.com

Order Literature: <http://www.onsemi.com/orderlit>

For additional information, please contact your local Sales Representative