

ON Semiconductor

Is Now

onsemi™

To learn more about onsemi™, please visit our website at
www.onsemi.com

onsemi and **onsemi** and other names, marks, and brands are registered and/or common law trademarks of Semiconductor Components Industries, LLC dba "**onsemi**" or its affiliates and/or subsidiaries in the United States and/or other countries. **onsemi** owns the rights to a number of patents, trademarks, copyrights, trade secrets, and other intellectual property. A listing of **onsemi** product/patent coverage may be accessed at www.onsemi.com/site/pdf/Patent-Marking.pdf. **onsemi** reserves the right to make changes at any time to any products or information herein, without notice. The information herein is provided "as-is" and **onsemi** makes no warranty, representation or guarantee regarding the accuracy of the information, product features, availability, functionality, or suitability of its products for any particular purpose, nor does **onsemi** assume any liability arising out of the application or use of any product or circuit, and specifically disclaims any and all liability, including without limitation special, consequential or incidental damages. Buyer is responsible for its products and applications using **onsemi** products, including compliance with all laws, regulations and safety requirements or standards, regardless of any support or applications information provided by **onsemi**. "Typical" parameters which may be provided in **onsemi** data sheets and/or specifications can and do vary in different applications and actual performance may vary over time. All operating parameters, including "Typicals" must be validated for each customer application by customer's technical experts. **onsemi** does not convey any license under any of its intellectual property rights nor the rights of others. **onsemi** products are not designed, intended, or authorized for use as a critical component in life support systems or any FDA Class 3 medical devices or medical devices with a same or similar classification in a foreign jurisdiction or any devices intended for implantation in the human body. Should Buyer purchase or use **onsemi** products for any such unintended or unauthorized application, Buyer shall indemnify and hold **onsemi** and its officers, employees, subsidiaries, affiliates, and distributors harmless against all claims, costs, damages, and expenses, and reasonable attorney fees arising out of, directly or indirectly, any claim of personal injury or death associated with such unintended or unauthorized use, even if such claim alleges that **onsemi** was negligent regarding the design or manufacture of the part. **onsemi** is an Equal Opportunity/Affirmative Action Employer. This literature is subject to all applicable copyright laws and is not for resale in any manner. Other names and brands may be claimed as the property of others.



Is Now Part of



ON Semiconductor®

To learn more about ON Semiconductor, please visit our website at

www.onsemi.com

ON Semiconductor and the ON Semiconductor logo are trademarks of Semiconductor Components Industries, LLC dba ON Semiconductor or its subsidiaries in the United States and/or other countries. ON Semiconductor owns the rights to a number of patents, trademarks, copyrights, trade secrets, and other intellectual property. A listing of ON Semiconductor's product/patent coverage may be accessed at www.onsemi.com/site/pdf/Patent-Marking.pdf. ON Semiconductor reserves the right to make changes without further notice to any products herein. ON Semiconductor makes no warranty, representation or guarantee regarding the suitability of its products for any particular purpose, nor does ON Semiconductor assume any liability arising out of the application or use of any product or circuit, and specifically disclaims any and all liability, including without limitation special, consequential or incidental damages. Buyer is responsible for its products and applications using ON Semiconductor products, including compliance with all laws, regulations and safety requirements or standards, regardless of any support or applications information provided by ON Semiconductor. "Typical" parameters which may be provided in ON Semiconductor data sheets and/or specifications can and do vary in different applications and actual performance may vary over time. All operating parameters, including "Typicals" must be validated for each customer application by customer's technical experts. ON Semiconductor does not convey any license under its patent rights nor the rights of others. ON Semiconductor products are not designed, intended, or authorized for use as a critical component in life support systems or any FDA Class 3 medical devices or medical devices with a same or similar classification in a foreign jurisdiction or any devices intended for implantation in the human body. Should Buyer purchase or use ON Semiconductor products for any such unintended or unauthorized application, Buyer shall indemnify and hold ON Semiconductor and its officers, employees, subsidiaries, affiliates, and distributors harmless against all claims, costs, damages, and expenses, and reasonable attorney fees arising out of, directly or indirectly, any claim of personal injury or death associated with such unintended or unauthorized use, even if such claim alleges that ON Semiconductor was negligent regarding the design or manufacture of the part. ON Semiconductor is an Equal Opportunity/Affirmative Action Employer. This literature is subject to all applicable copyright laws and is not for resale in any manner.



User Guide for
FEBFL7701_L34U018A
Evaluation Board

Universal Line Voltage LED Ballast

Featured Fairchild Product:
FL7701

***Direct questions or comments
about this evaluation board to:
“Worldwide Direct Support”***

Fairchild Semiconductor.com



Table of Contents

1. Introduction.....	3
1.1. General Description	3
1.2. Features	3
1.3. Internal Block Diagram.....	4
2. General Specifications for Evaluation Board	5
3. Photographs.....	6
4. Printed Circuit Board	6
5. Schematic	7
6. Bill of Materials	8
7. Performance of Evaluation Board.....	9
7.1. Typical Waveforms: Startup.....	10
7.2. Operating Frequency & Minimum Duty.....	11
7.3. Typical Waveforms: Steady State.....	12
7.4. Typical Waveforms: Abnormal Mode (LED-Open).....	15
7.5. Typical Waveforms: Abnormal Mode (Inductor Short)	16
7.6. System Efficiency	17
7.7. Power Factor at Rated Load Condition.....	18
7.8. THD Performance at Rated Load Condition	19
7.9. Thermal Performance at Rated Load Condition	20
7.10. Electromagnetic Interference (EMI) Result.....	22
8. Revision History	24

This user guide supports the evaluation kit for the FL7701, FEBFL7701_L34U018A. It should be used in conjunction with the FL7701 datasheets as well as Fairchild's application notes and technical support team. Please visit Fairchild's website at www.fairchildsemi.com.

1. Introduction

This document describes the proposed solution for a universal input 18.3 W LED ballast using the FL7701. The input voltage range is $90 V_{RMS} - 264 V_{RMS}$ and there is one DC output with a constant current of 470 mA at $39 V_{MAX}$. This document contains general description of FL7701, the power supply specification, schematic, bill of materials, and the typical operating characteristics.

1.1. General Description

The FL7701 LED lamp driver is a simple IC with a Power Factor Correction (PFC) function. The special "adopted digital" technique of the IC can automatically detect input voltage condition Zero-Crossing Detector (ZCD) and send a internal reference signal for high power factor. When AC input is applied to the IC, PFC function is automatically enabled. When DC input is applied to the IC, PFC function is automatically disabled. The FL7701 does not need a bulk capacitor (electrolytic capacitor) for supply rails stability, which can significantly affect to LED lamp system.

1.2. Features

- Digitally Implemented Active PFC Function (No Additional Circuit Necessary for High PF)
- Built-in HV Supplying Circuit: Self Biasing
- AOCF Function with Auto-Restart Mode
- Built-in Over-Temperature Protection (OTP)
- Cycle-by-Cycle Current Limit
- Low Operating Current: 0.85 mA (Typical)
- Under-Voltage Lockout with 5 V Hysteresis
- Programmable Oscillation Frequency
- Programmable LED Current
- Analog Dimming Function
- Soft-Start Function
- Precise Internal Reference: $\pm 3\%$

1.3. Internal Block Diagram

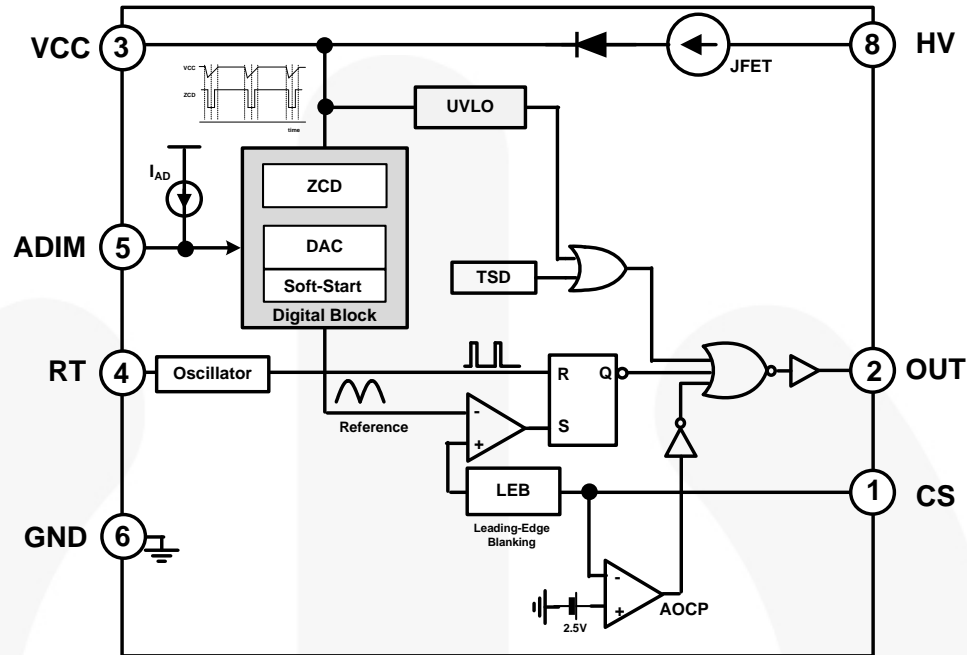

Figure 1. Block Diagram

Table 1. Pin Definitions

Pin	Name	Description
1	CS	Current Sense. Limits output current, depending on the sensing resistor voltage. The CS pin is also used to set the LED current regulation.
2	OUT	Output. Connects to the MOSFET gate.
3	VCC	Supply Voltage. Supply pin for stable IC operation; ZCD signal detection used for accurate PFC function.
4	RT	Resistor. Programmable operating frequency using an external resistor connected to this PIN and the IC has fixed frequency when this pin is left open or floating.
5	ADIM	Analog Dimming. Connects to the internal current source and can change the output current using an external resistor. If ADIM is not used, connect a 0.1 μ F bypass capacitor between ADIM and GND.
6	GND	GROUND. Ground for the IC.
7	NC	No Connection
8	HV	High Voltage. Connect to the high-voltage line and supply current to the IC

2. General Specifications for Evaluation Board

All data for this table was measured at an ambient temperature of 25°C.

Table 2. Summary of Features and Performance

Description	Symbol	Value	Comments
Input Voltage Range	$V_{IN,MIN}$	90 V	Minimum Input Voltage
	$V_{IN,NORMAL}$	110 V / 220 V	Normal Input Voltage
	$V_{IN,MAX}$	264 V	Maximum Input voltage
AC Input Frequency	$f_{IN,MIN}$	47 Hz	Minimum Input Frequency
	$f_{IN,MAX}$	64 Hz	Maximum Input Frequency
Output Voltage	$V_{OUT,MAX}$	41 V	Maximum Output Voltage
	$V_{OUT,NORMAL}$	39 V	Normal Output Voltage
	$V_{OUT,MIN}$	37 V	Minimum Output Voltage
Output Current ⁽¹⁾	$I_{OUT,NORMAL}$	470 mA	Normal Output Current
	CC deviation	< ±4.5%	Line Input Voltage Change: 90~264 V _{AC}
Output Power ⁽²⁾	Output Power	18.3 W	
Efficiency		>83%	At Full Load
Temperature	T_{FL7701}	< 63°C	At full load (all at open-frame, room temperature / still air)
	$T_{DM \text{ filter}}$	< 69°C	
	$T_{FRD,ES3J}$	< 61°C	
	T_{MOSFET}	< 68°C	
	$T_{inductor}$	< 50°C	
PCB Size			18 mm (width) x 295 mm (length) x 10mm (height)
Initial Application			L-Tube

Notes:

- The output current has I_{LEDPK} ripple. To reduce ripple current, use a large electrolytic capacitor in parallel with the LED. Ensure the capacitor voltage rating is high enough to withstand an open-LED condition or use a Zener diode for protection.
- The output power is not equal to the apparent power due to the slight phase shift between the output voltage and current.

3. Photographs



Figure 2. Top View, Length: 295mm



Figure 3. Width: 18mm

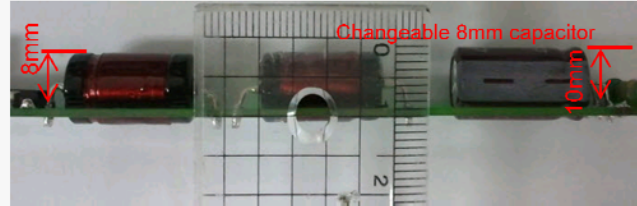

Figure 4. Height: 10mm (Include PCB)

4. Printed Circuit Board

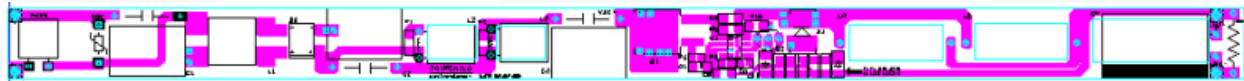

Figure 5. Top Side (18mm x 295mm)



Figure 6. Bottom Side (18mm x 295mm)

6. Bill of Materials

Item No.	Part Reference	Part Number	Qty.	Description	Manufacturer
1	U1	FL7701	1	Controller	Fairchild Semiconductor
2	Fuse	SS-5-1A	1	1 A / 250 V Fuse	Cooper Bussmann
3	MOV	MOV-10D471K	1	VARISTOR 470 V 10MM RADIAL	Bourns Inc.
4	L1	LF-1480-253	1	Line Filter	Sejin Telecom (www.sejintel.com)
5	L2, L3	RFB0810-472	2	4.7 mH Inductor	Coil Craft
6	L4, L5	PCH-45x-475	2	4.7 mH Inductor	Coil Craft
7	BD	DF04S	1	400 V / 1.5 A, Bridge Rectifier	Fairchild Semiconductor
8	D1	1N4148	1	100 V / 200 mA, Small Signal Diode	Fairchild Semiconductor
9	D2	RS1M	1	1000 V / 1 A, Fast Rectifier	Fairchild Semiconductor
10	D3	ES3J	1	600 V / 3 A, Fast Rectifier	Fairchild Semiconductor
11	ZD1	MMSZ5230B	1	4.7 V / 0.5 W Zener Diode	Fairchild Semiconductor
12	Q1	FQD2N60	1	2 A / 600 V MOSFET	Fairchild Semiconductor
13	Q2	FQN1N50C	1	1 A / 500 V MOSFET	Fairchild Semiconductor
14	C1	PCX2 335M MKP 100nF	1	100 nF / 275 V _{AC} , X-Cap	PILKOR
15	C2	MPE 630V104K	1	0.1 μF / 630 V _{AC} , 10%, Polypropylene	Sungho
16	C3	MPE 400V334K	1	0.33 μF / 400 V _{AC} , 10%, Polypropylene	Sungho
17	C4, C5	C1206C225K5PACTU	2	2.2 μF / 50V SMD Capacitor 3216	Kemet
18	C6	C0805C104K3RACTU	1	0.1 μF / 25V SMD Capacitor 2012	Kemet
19	C7	C1206C102K5PACTU	1	1 nF / 50V SMD Capacitor 3216	Kemet
20	C8	C1206C105K5PACTU	1	1 μF / 50 V SMD Capacitor 3216	Kemet
21	C9	KMG 330 μF / 63 V	1	330 μF / 63 V Electrolytic Capacitor	SamYoung
22	R1, R2	RC1106JR-07151RL	2	150 Ω RES, SMD, 1/4W, 3216	Yageo
23	R3	RC0805JR-07331RL	1	330 Ω RES, SMD, 1/8W, 2012	Yageo
24	R4, R5	RC1106JR-070R9RL	2	0.9 Ω RES, SMD, 1/4W, 3216	Yageo
25	R6	RC1106JR-07204RL	1	200 kΩ RES, SMD, 1/4W, 3216	Yageo
26	R7	RC1106JR-07153RL	1	15 kΩ RES, SMD, 1/4W, 3216	Yageo
27	R8	RC0805JR-07823RL	1	82 kΩ RES, SMD, 1/8W, 2012	Yageo
28	R9	10.0KBZTB-ND	1	10 kΩ / 1 W Resistor	Yageo
29	R10	RC1106JR-07000RL	1	0 Ω RES, SMD, 1/4W, 3216	Yageo

7. Performance of Evaluation Board

Table 3. Test Condition & Equipments

Test Temperature	T _A = 25°C, Open-Flame
Test Equipment	AC Source : PCR500L by Kikusui Power Meter : PZ4000 by Yokogawa Oscilloscope : waverunner 64Xi by Lecroy EMI Test Receiver: ESCS30 by ROHDE & SCHWARZ Two-Line V-Network: ENV216 by ROHDE & SCHWARZ Thermometer : CAM SC640 by FLIR SYSTEMS LED: EHP-AX08EL/GT01H-P03 (3W) by Everlight

7.1. Typical Waveforms: Startup

Figure 8 through Figure 11 show the typical startup performance at different input voltage conditions. When AC input voltage is applied to the system, the FL7701 automatically operates in AC Mode after finishing an internally fixed, seven-cycle, soft-start period.

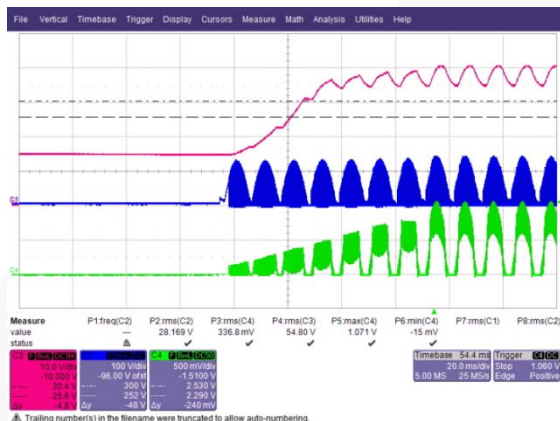

Figure 8. Soft-Start Characteristics at 90 V_{AC} (47 Hz) CH2: V_{OUT}, CH3: V_{DRAIN}, CH4: I_{INDUCTOR}

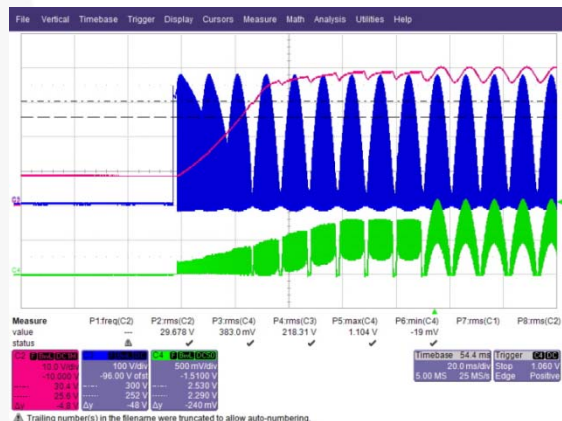

Figure 9. Soft-Start Characteristics at 264 V_{AC} (47 Hz) CH2: V_{OUT}, CH3: V_{DRAIN}, CH4: I_{INDUCTOR}

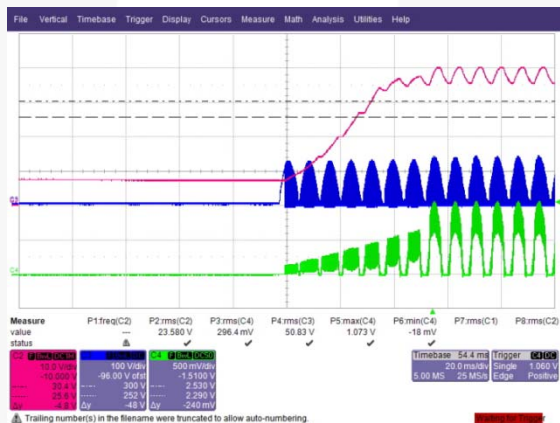

Figure 10. Soft-Start Characteristics at 90 V_{DC} (64 Hz) CH2: V_{OUT}, CH3: V_{DRAIN}, CH4: I_{INDUCTOR}

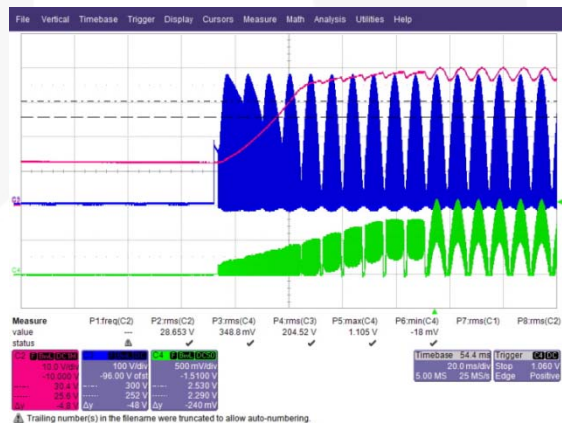

Figure 11. Soft-Start Characteristics at 264 V_{DC} (64 Hz) CH2: V_{OUT}, CH3: V_{DRAIN}, CH4: I_{INDUCTOR}

7.2. Operating Frequency & Minimum Duty

The recommended switching frequency of FL7701 is around 20 kHz ~ 250 kHz and it is determined by the RT resistor and has prefixed output frequency in RT-open condition. The maximum duty ratio is fixed below 50% and pre-fixed minimum on time is around 400 ns. There are two considerable points to design properly. The first, consider the minimum duty at low input voltage because the FL7701 cannot get higher than 50% duty ratio. This means the FL7701 should have duty margin. The other is minimum on-time at high input voltage condition. The FL7701 cannot control output power when the set point is smaller than on time at very high input voltage. On-time margin must be considered.

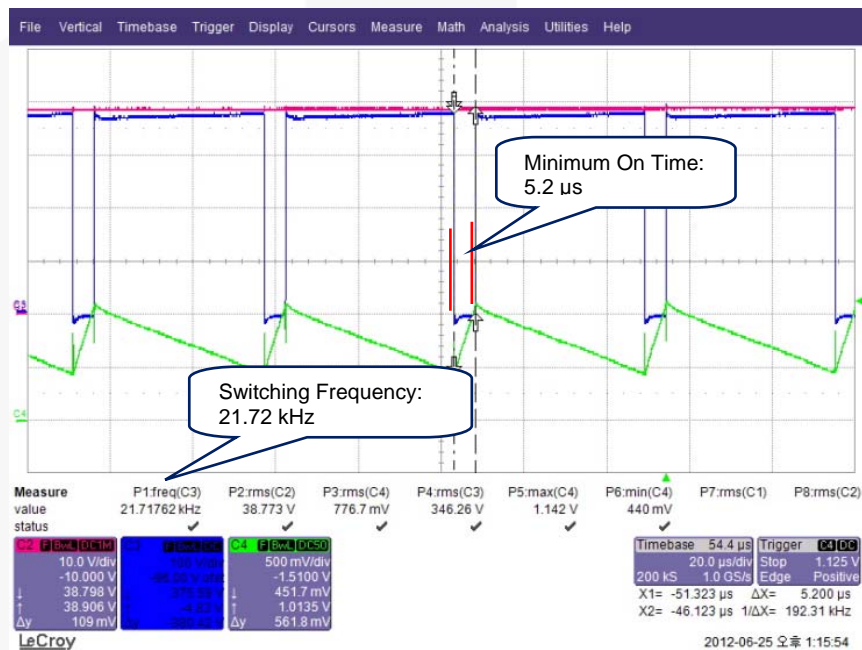

Figure 12. Operating Frequency & Minimum Duty
CH2: V_{OUT}, CH3: V_{DRAIN}, CH4: I_{INDUCTOR}

7.3. Typical Waveforms: Steady State

Figure 13 through Figure 22 show the normal operation waveforms by input voltage and input frequency. The output voltage and current always keeps a certain output level with (input frequency $\times 2$) ripple and the test results are provided in Table 5.

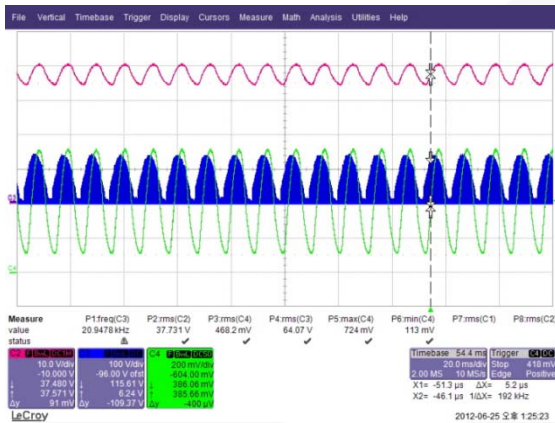

Figure 13. Input Voltage: 90 V_{AC}, Input Frequency: 47 Hz, CH2: V_{OUT}, CH3: V_{DRAIN}, CH4: I_{LED}

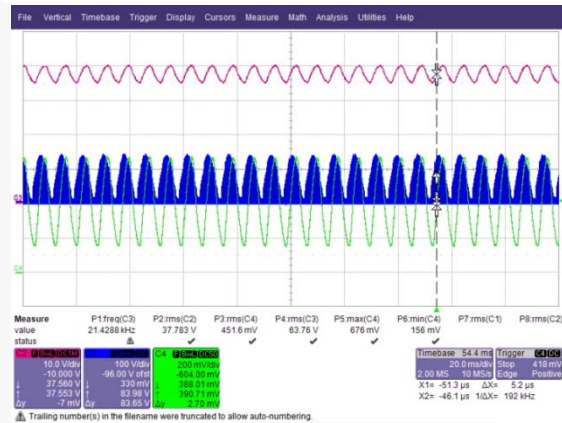

Figure 14. Input Voltage: 90 V_{AC}, Input Frequency: 64 Hz, CH2: V_{OUT}, CH3: V_{DRAIN}, CH4: I_{LED}

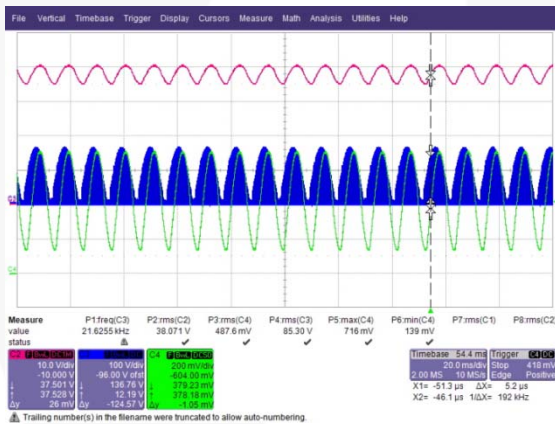

Figure 15. Input Voltage: 110 V_{AC}, Input Frequency: 47 Hz, CH2: V_{OUT}, CH3: V_{DRAIN}, CH4: I_{LED}

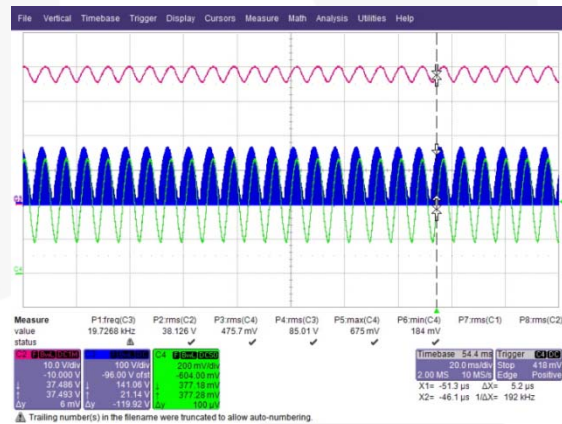

Figure 16. Input Voltage: 110 V_{AC}, Input Frequency: 64 Hz, CH2: V_{OUT}, CH3: V_{DRAIN}, CH4: I_{LED}

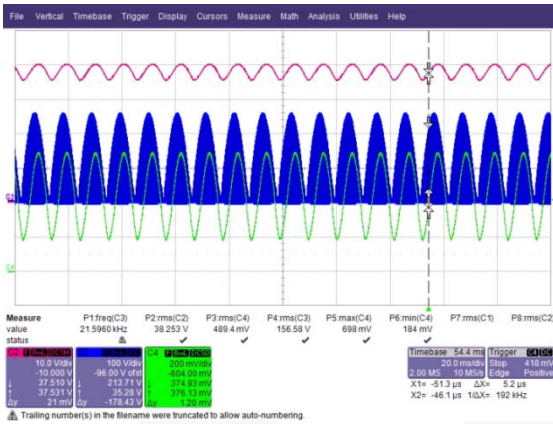

Figure 17. Input Voltage: 180 V_{AC}, Input Frequency: 47 Hz, CH2: V_{OUT}, CH3: V_{DRAIN}, CH4: I_{LED}

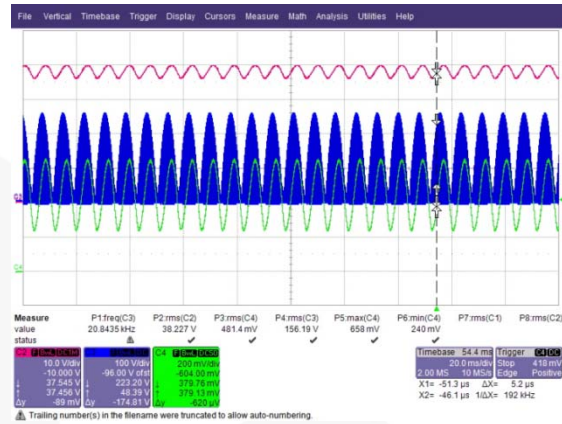

Figure 18. Input Voltage: 180 V_{AC}, Input Frequency: 64 Hz, CH2: V_{OUT}, CH3: V_{DRAIN}, CH4: I_{LED}

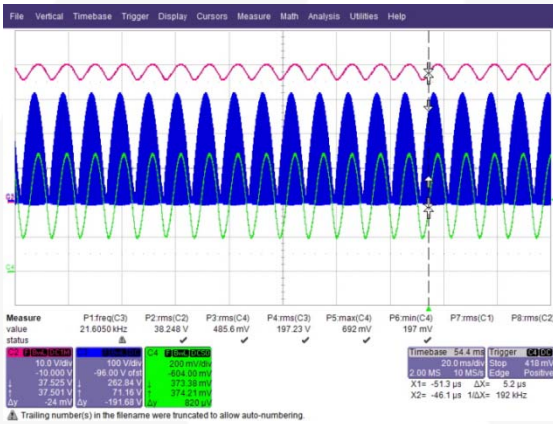

Figure 19. Input Voltage: 220 V_{AC}, Input Frequency: 47 Hz, CH2: V_{OUT}, CH3: V_{DRAIN}, CH4: I_{LED}

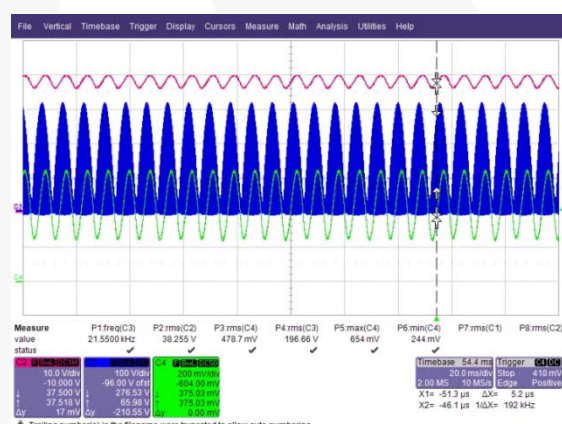

Figure 20. Input Voltage: 220 V_{AC}, Input Frequency: 64 Hz, CH2: V_{OUT}, CH3: V_{DRAIN}, CH4: I_{LED}

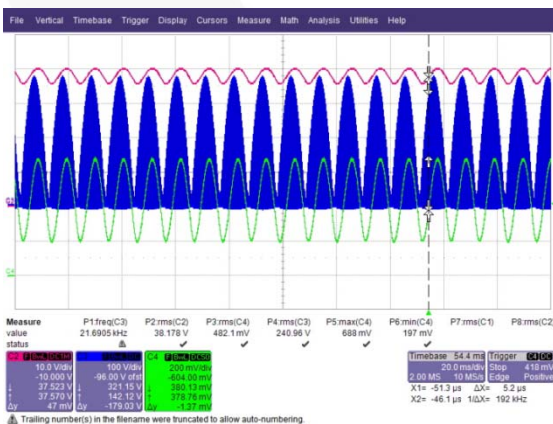

Figure 21. Input Voltage: 264 V_{AC}, Input Frequency: 47 Hz, CH2: V_{OUT}, CH3: V_{DRAIN}, CH4: I_{LED}

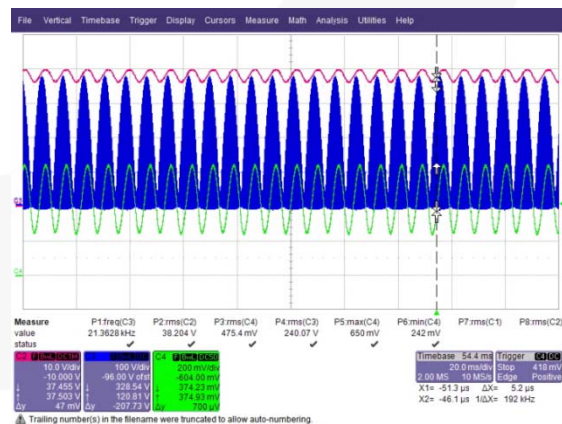

Figure 22. Input Voltage: 264 V_{AC}, Input Frequency: 64 Hz, CH2: V_{OUT}, CH3: V_{DRAIN}, CH4: I_{LED}

I_o [A]

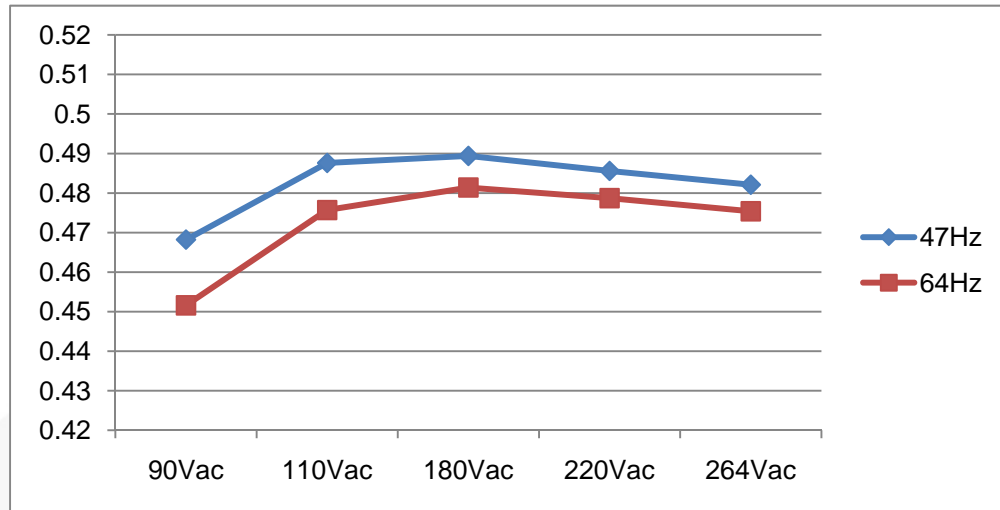

Figure 23. CC Deviation Curve

Table 4. Output Characteristics by Input Voltage & Frequency

	47 Hz		64 Hz	
	$V_{LED(RMS)}$ (V)	$I_{LED(RMS)}$ (mA)	$V_{LED(RMS)}$ (V)	$I_{LED(RMS)}$ (mA)
90 V_{AC}	37.73	468.2	37.78	451.6
110 V_{AC}	38.07	487.6	38.13	475.7
180 V_{AC}	38.25	489.4	38.23	481.4
220 V_{AC}	38.25	485.6	38.26	478.7
264 V_{AC}	38.18	482.1	38.20	475.4
Deviation		4.33%		6.19%

7.4. Typical Waveforms: Abnormal Mode (LED-Open)

Figure 24 shows the open-load condition test method. If the LED disconnects from the system, the output voltage increases up to match the voltage of the input source. Add the output voltage clamping circuit or the special protection circuit to protect components, especially output capacitor.

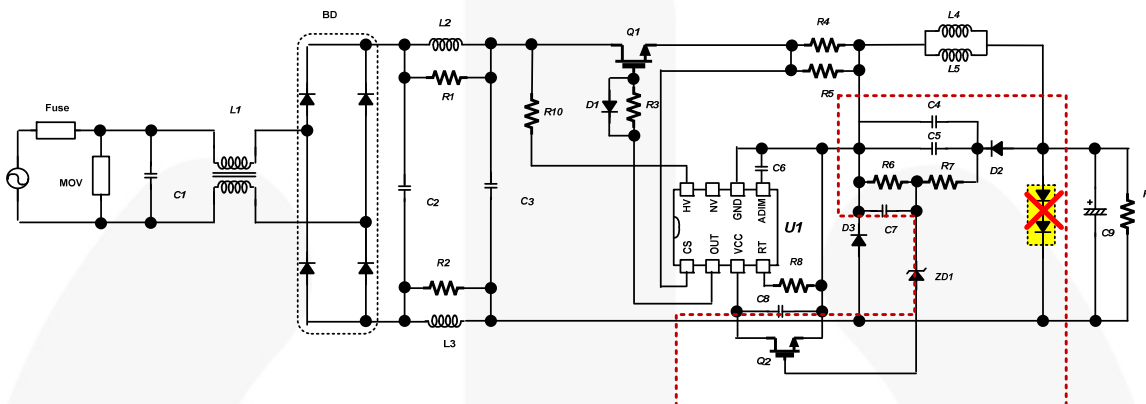

Figure 24. Open-LED Condition

The Figure 25 shows the test results of waveform in LED-open condition; the output voltage clamps a certain level.

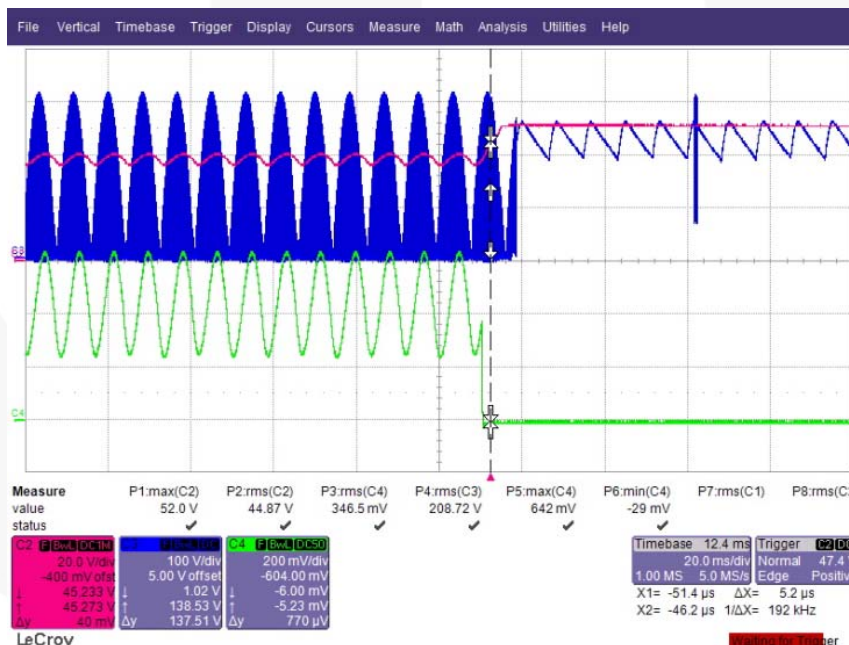

Figure 25. Output Waveforms at LED-OPEN Condition

CH2: V_{OUT}, CH3: V_{DRAIN}, CH4: I_{LED}

7.5. Typical Waveforms: Abnormal Mode (Inductor Short)

Figure 26 and Figure 27 show the test method and result of an inductor short. The FL7701 uses an Abnormal Over-Current Protection (AOCP) function, limiting the current on RCS in the event of an inductor short.

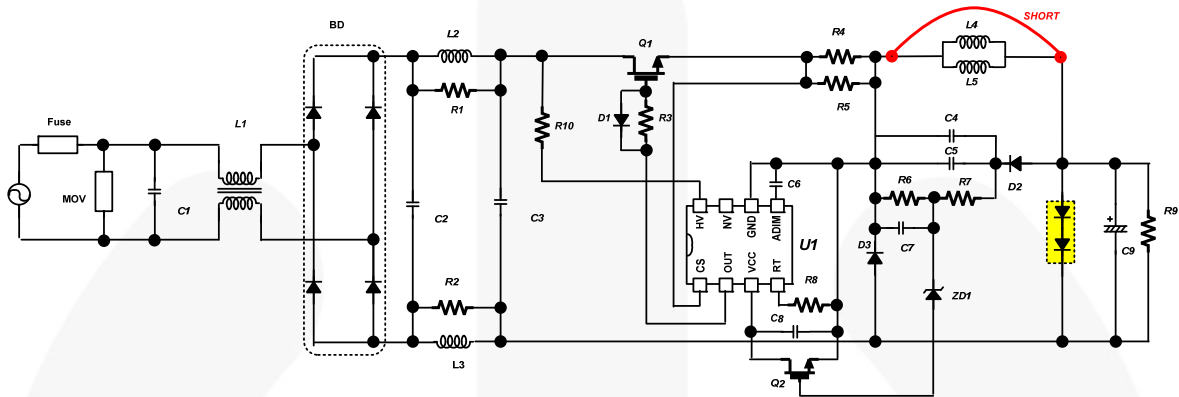

Figure 26. Inductor Short Condition

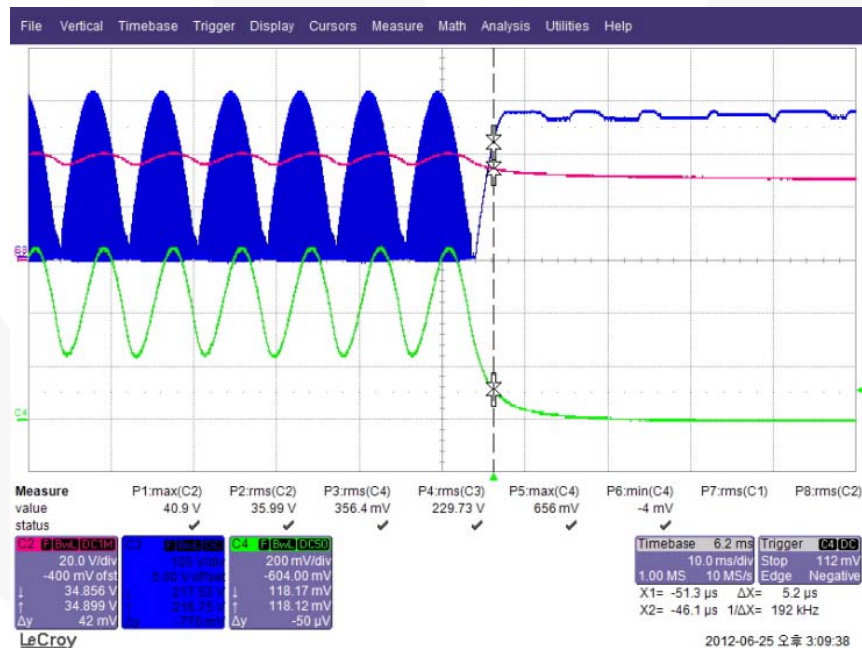

Figure 27. Test Result of Inductor Short Condition
CH2: V_{OUT}, CH3: V_{DRAIN}, CH4: I_{LED}

7.6. System Efficiency

Figure 28 shows system efficiency results for different AC input voltage frequency conditions. As shown, the input frequency has negligible effect on system efficiency.

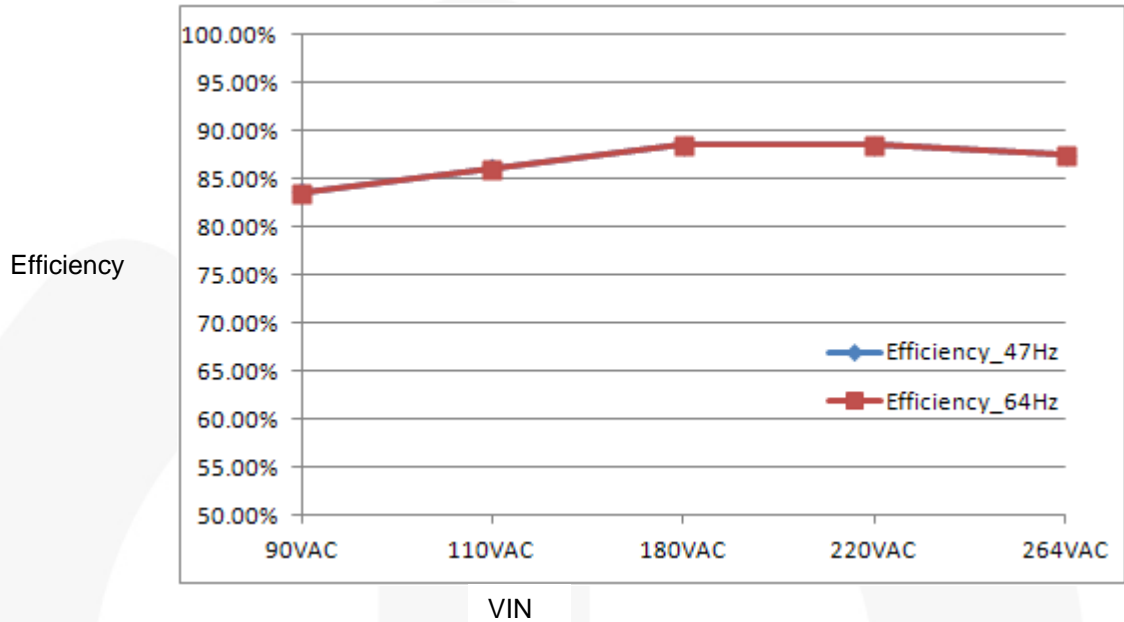

Figure 28. System Efficiency

Table 5. Test Result of System Efficiency

Input Voltage		Efficiency (%)
90 V _{AC}	47 Hz	83.63
	64 Hz	83.55
110 V _{AC}	47 Hz	86.18
	64 Hz	86.06
180 V _{AC}	47 Hz	88.52
	64 Hz	88.56
220 V _{AC}	47 Hz	88.58
	64 Hz	88.52
264 V _{AC}	47 Hz	87.53
	64 Hz	87.51

7.7. Power Factor at Rated Load Condition

Figure 29 shows the system Power Factor (PF) performance for the entire input voltage range (90 V_{AC} to 264 V_{AC}) at different input frequency conditions (47 Hz, 64 Hz). The PF changes slightly according to the input frequency.

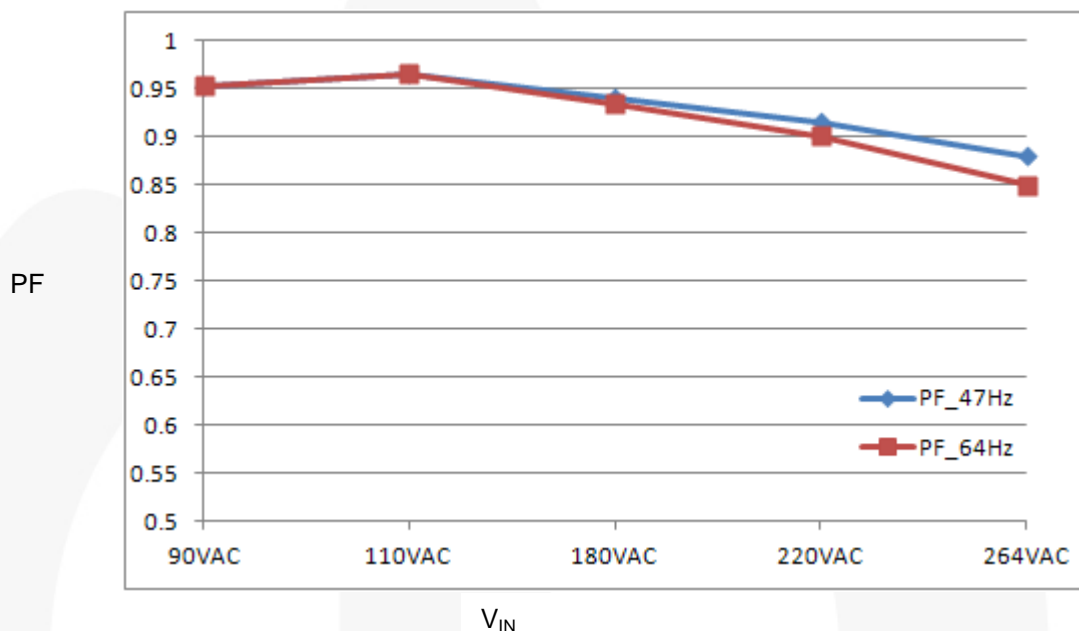

Figure 29. Power Factor

Table 6. Power Factor Test Results

Input Voltage		Power Factor
90 V _{AC}	47 Hz	0.95
	64 Hz	0.95
110 V _{AC}	47 Hz	0.96
	64 Hz	0.96
180 V _{AC}	47 Hz	0.94
	64 Hz	0.93
220 V _{AC}	47 Hz	0.91
	64 Hz	0.90
264 V _{AC}	47 Hz	0.88
	64 Hz	0.85

7.8. THD Performance at Rated Load Condition

Figure 30 shows the Total Harmonic Distortion (THD) performance at different input frequencies. Test results are similar; THD meets international regulations (under 30%).

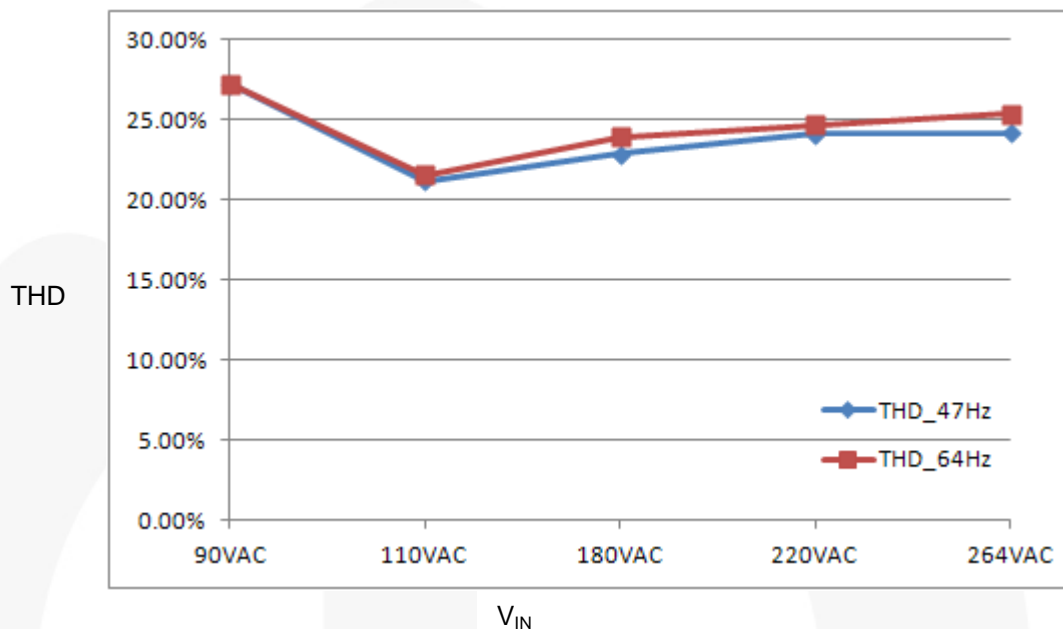

Figure 30. Total Harmonic Distortion Performance

Table 7. THD Test Result

Input Voltage		THD (%)
90 V _{AC}	47 Hz	27.24
	64 Hz	27.25
110 V _{AC}	47 Hz	21.18
	64 Hz	21.54
180 V _{AC}	47 Hz	22.88
	64 Hz	23.97
220 V _{AC}	47 Hz	24.10
	64 Hz	24.71
264 V _{AC}	47 Hz	24.19
	64 Hz	25.40

7.9. Thermal Performance at Rated Load Condition

The Figure 31 through Figure 35 show the temperature checking results on the board, depending on different input voltage conditions. All of the components temperatures are below 69°C in whole input voltage condition.

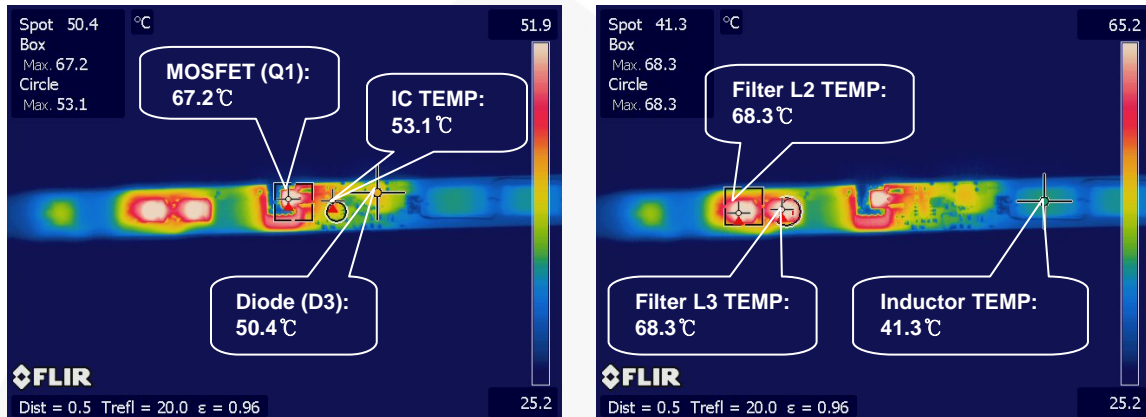

Figure 31. Thermal Test Result at 90V_{AC} Condition

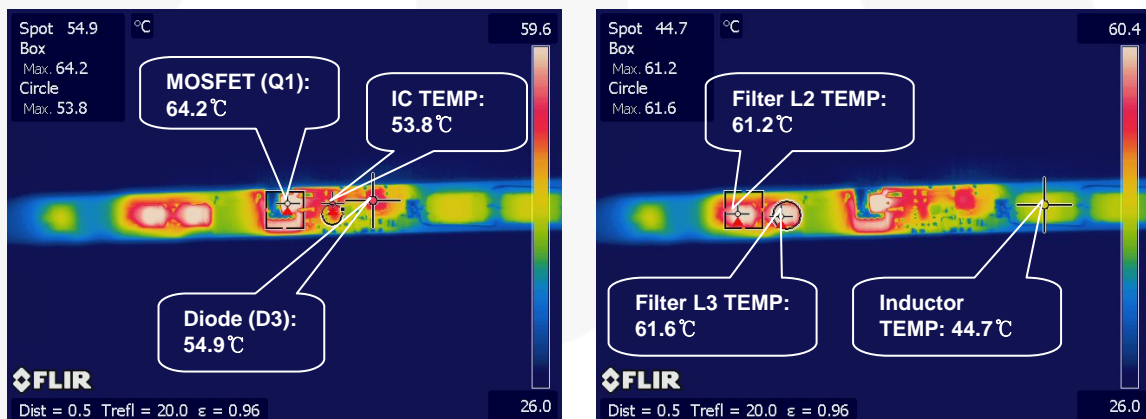

Figure 32. Thermal Test Result at 110V_{AC} Condition

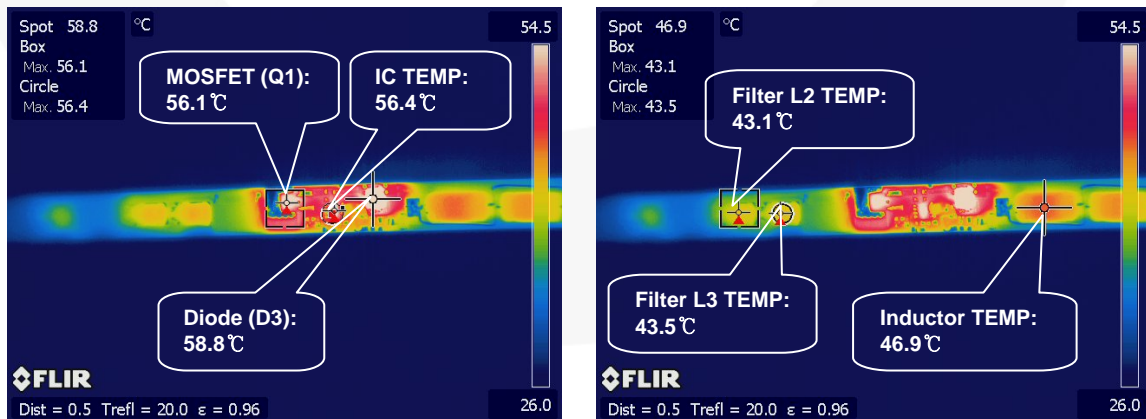

Figure 33. Thermal Test Result at 180 V_{AC} Condition

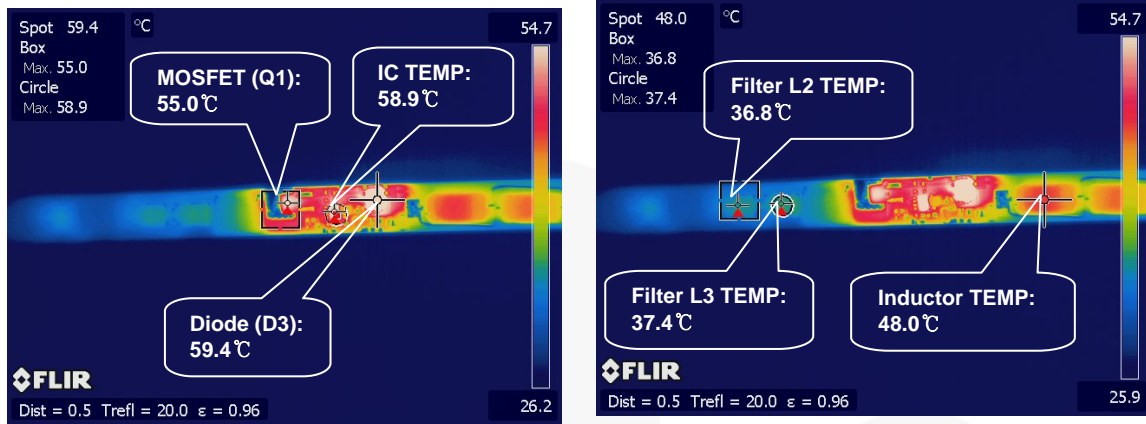

Figure 34. Thermal Test Result at 220 V_{AC} Condition

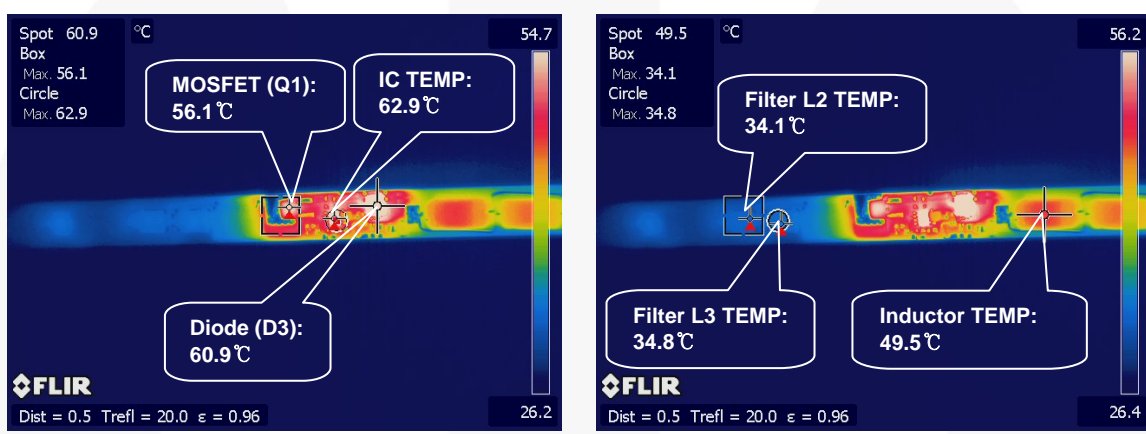

Figure 35. Thermal Test Result at 264 V_{AC} Condition

Table 8. Temperature Performance by Input Voltage

	IC	MOSFET (Q1)	Diode (D3)	Filter L2	Filter L3	Inductor
90 V_{AC}	53.1°C	67.2°C	50.4°C	68.3°C	68.3°C	41.3°C
110 V_{AC}	53.8°C	64.2°C	54.9°C	61.2°C	61.6°C	44.7°C
180 V_{AC}	56.4°C	56.1°C	58.8°C	43.1°C	43.5°C	46.9°C
220 V_{AC}	58.9°C	55.0°C	59.4°C	36.8°C	37.4°C	48.0°C
264 V_{AC}	62.9°C	56.1°C	60.9°C	34.1°C	34.8°C	49.5°C

7.10. Electromagnetic Interference (EMI) Result

All measurement was conducted in observance of CISPR22 criteria. This regulation is tighter than the CISPR15 regulation for lighting applications.

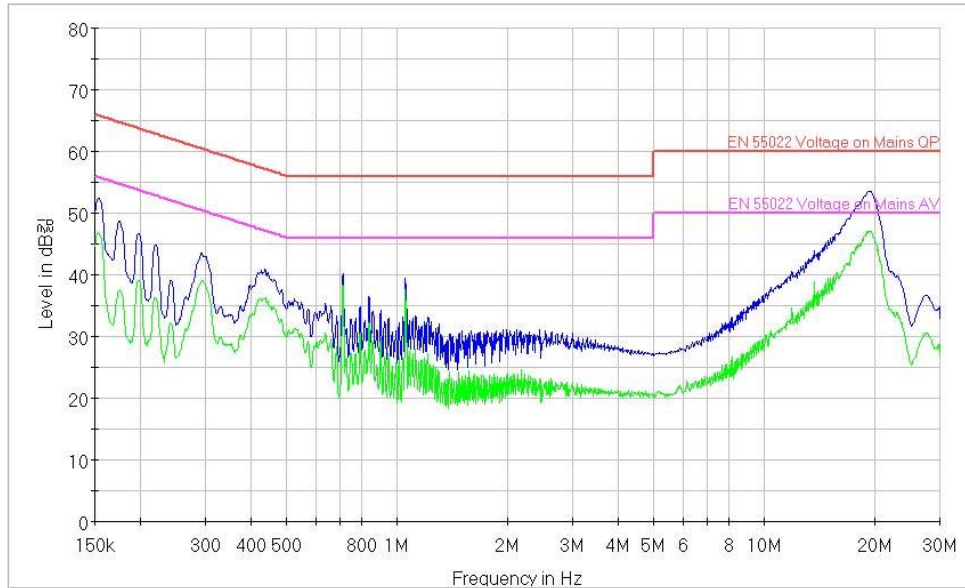

Figure 36. Conducted Emission-Line at 110 V_{AC}, Full Load (10-LED in Series)

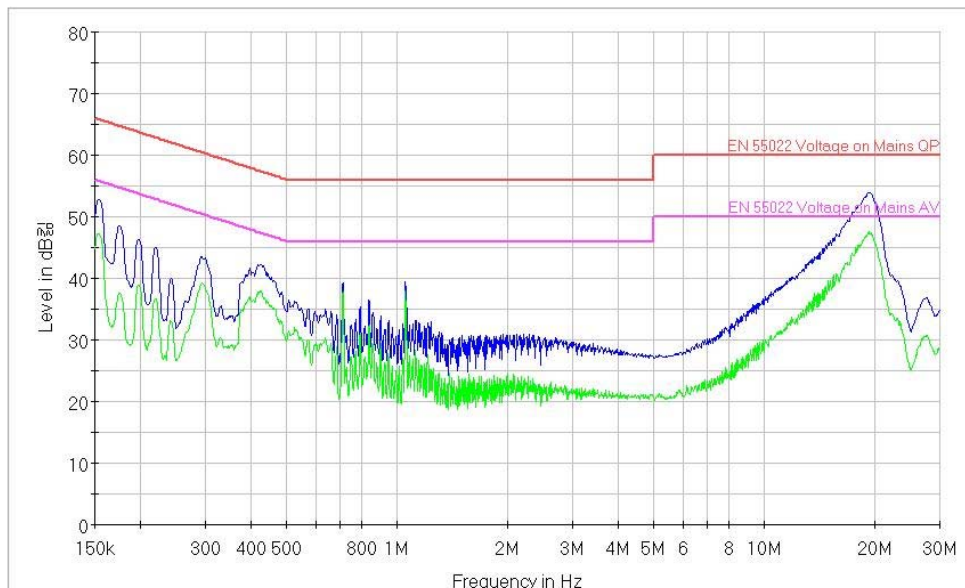

Figure 37. Conducted Emission-Neutral at 110 V_{AC}, Full Load (10-LED in Series)

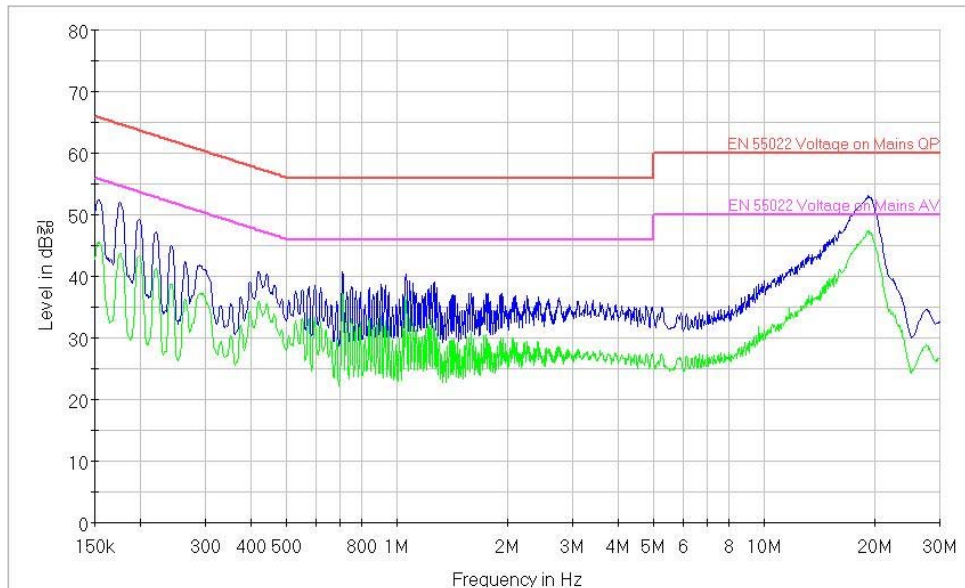

Figure 38. Conducted Emission-Line at 220 V_{AC}, Full Load (10-LED in Series)

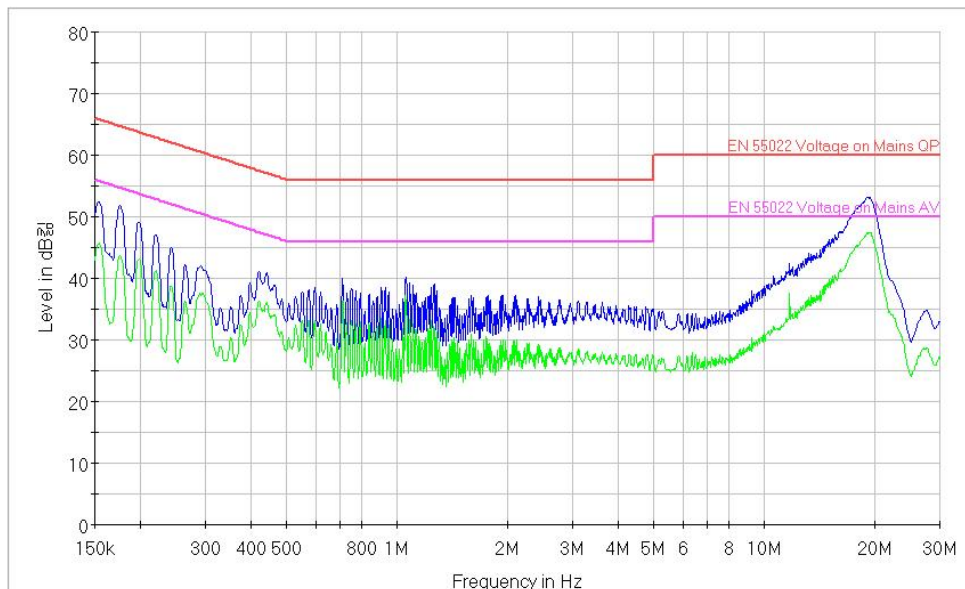

Figure 39. Conducted Emission-Neutral at 220 V_{AC}, Full Load (10-LED in Series)

8. Revision History

Rev.	Date	Description
1.0.0	July 2012	Initial Release
1.0.1	September 2012	Part number update to FEBFL7701_L34U018A, added spaces for UOM

WARNING AND DISCLAIMER

Replace components on the Evaluation Board only with those parts shown on the parts list (or Bill of Materials) in the Users' Guide. Contact an authorized Fairchild representative with any questions.

This board is intended to be used by certified professionals, in a lab environment, following proper safety procedures. Use at your own risk. The Evaluation board (or kit) is for demonstration purposes only and neither the Board nor this User's Guide constitute a sales contract or create any kind of warranty, whether express or implied, as to the applications or products involved. Fairchild warrants that its products meet Fairchild's published specifications, but does not guarantee that its products work in any specific application. Fairchild reserves the right to make changes without notice to any products described herein to improve reliability, function, or design. Either the applicable sales contract signed by Fairchild and Buyer or, if no contract exists, Fairchild's standard Terms and Conditions on the back of Fairchild invoices, govern the terms of sale of the products described herein.

DISCLAIMER

FAIRCHILD SEMICONDUCTOR RESERVES THE RIGHT TO MAKE CHANGES WITHOUT FURTHER NOTICE TO ANY PRODUCTS HEREIN TO IMPROVE RELIABILITY, FUNCTION, OR DESIGN. FAIRCHILD DOES NOT ASSUME ANY LIABILITY ARISING OUT OF THE APPLICATION OR USE OF ANY PRODUCT OR CIRCUIT DESCRIBED HEREIN; NEITHER DOES IT CONVEY ANY LICENSE UNDER ITS PATENT RIGHTS, NOR THE RIGHTS OF OTHERS.

LIFE SUPPORT POLICY

FAIRCHILD'S PRODUCTS ARE NOT AUTHORIZED FOR USE AS CRITICAL COMPONENTS IN LIFE SUPPORT DEVICES OR SYSTEMS WITHOUT THE EXPRESS WRITTEN APPROVAL OF THE PRESIDENT OF FAIRCHILD SEMICONDUCTOR CORPORATION.

As used herein:

1. Life support devices or systems are devices or systems which, (a) are intended for surgical implant into the body, or (b) support or sustain life, or (c) whose failure to perform when properly used in accordance with instructions for use provided in the labeling, can be reasonably expected to result in significant injury to the user.
2. A critical component is any component of a life support device or system whose failure to perform can be reasonably expected to cause the failure of the life support device or system, or to affect its safety or effectiveness.

ANTI-COUNTERFEITING POLICY

Fairchild Semiconductor Corporation's Anti-Counterfeiting Policy. Fairchild's Anti-Counterfeiting Policy is also stated on our external website, www.fairchildsemi.com, under Sales Support.

Counterfeiting of semiconductor parts is a growing problem in the industry. All manufacturers of semiconductor products are experiencing counterfeiting of their parts. Customers who inadvertently purchase counterfeit parts experience many problems such as loss of brand reputation, substandard performance, failed applications, and increased cost of production and manufacturing delays. Fairchild is taking strong measures to protect ourselves and our customers from the proliferation of counterfeit parts. Fairchild strongly encourages customers to purchase Fairchild parts either directly from Fairchild or from Authorized Fairchild Distributors who are listed by country on our web page cited above. Products customers buy either from Fairchild directly or from Authorized Fairchild Distributors are genuine parts, have full traceability, meet Fairchild's quality standards for handling and storage and provide access to Fairchild's full range of up-to-date technical and product information. Fairchild and our Authorized Distributors will stand behind all warranties and will appropriately address any warranty issues that may arise. Fairchild will not provide any warranty coverage or other assistance for parts bought from Unauthorized Sources. Fairchild is committed to combat this global problem and encourage our customers to do their part in stopping this practice by buying direct or from authorized distributors.

EXPORT COMPLIANCE STATEMENT

These commodities, technology, or software were exported from the United States in accordance with the Export Administration Regulations for the ultimate destination listed on the commercial invoice. Diversion contrary to U.S. law is prohibited.

U.S. origin products and products made with U.S. origin technology are subject to U.S. Re-export laws. In the event of re-export, the user will be responsible to ensure the appropriate U.S. export regulations are followed.

ON Semiconductor and  are trademarks of Semiconductor Components Industries, LLC dba ON Semiconductor or its subsidiaries in the United States and/or other countries. ON Semiconductor owns the rights to a number of patents, trademarks, copyrights, trade secrets, and other intellectual property. A listing of ON Semiconductor's product/patent coverage may be accessed at www.onsemi.com/site/pdf/Patent-Marking.pdf. ON Semiconductor reserves the right to make changes without further notice to any products herein. ON Semiconductor makes no warranty, representation or guarantee regarding the suitability of its products for any particular purpose, nor does ON Semiconductor assume any liability arising out of the application or use of any product or circuit, and specifically disclaims any and all liability, including without limitation special, consequential or incidental damages. Buyer is responsible for its products and applications using ON Semiconductor products, including compliance with all laws, regulations and safety requirements or standards, regardless of any support or applications information provided by ON Semiconductor. "Typical" parameters which may be provided in ON Semiconductor data sheets and/or specifications can and do vary in different applications and actual performance may vary over time. All operating parameters, including "Typicals" must be validated for each customer application by customer's technical experts. ON Semiconductor does not convey any license under its patent rights nor the rights of others. ON Semiconductor products are not designed, intended, or authorized for use as a critical component in life support systems or any FDA Class 3 medical devices or medical devices with a same or similar classification in a foreign jurisdiction or any devices intended for implantation in the human body. Should Buyer purchase or use ON Semiconductor products for any such unintended or unauthorized application, Buyer shall indemnify and hold ON Semiconductor and its officers, employees, subsidiaries, affiliates, and distributors harmless against all claims, costs, damages, and expenses, and reasonable attorney fees arising out of, directly or indirectly, any claim of personal injury or death associated with such unintended or unauthorized use, even if such claim alleges that ON Semiconductor was negligent regarding the design or manufacture of the part. ON Semiconductor is an Equal Opportunity/Affirmative Action Employer. This literature is subject to all applicable copyright laws and is not for resale in any manner.

PUBLICATION ORDERING INFORMATION

LITERATURE FULFILLMENT:

Literature Distribution Center for ON Semiconductor
19521 E. 32nd Pkwy, Aurora, Colorado 80011 USA
Phone: 303-675-2175 or 800-344-3860 Toll Free USA/Canada
Fax: 303-675-2176 or 800-344-3867 Toll Free USA/Canada
Email: orderlit@onsemi.com

N. American Technical Support: 800-282-9855 Toll Free
USA/Canada
Europe, Middle East and Africa Technical Support:
Phone: 421 33 790 2910
Japan Customer Focus Center
Phone: 81-3-5817-1050

ON Semiconductor Website: www.onsemi.com
Order Literature: <http://www.onsemi.com/orderlit>
For additional information, please contact your local
Sales Representative