

# ON Semiconductor

## Is Now

# onsemi™

To learn more about onsemi™, please visit our website at  
[www.onsemi.com](http://www.onsemi.com)

---

**onsemi** and **onsemi** and other names, marks, and brands are registered and/or common law trademarks of Semiconductor Components Industries, LLC dba "**onsemi**" or its affiliates and/or subsidiaries in the United States and/or other countries. **onsemi** owns the rights to a number of patents, trademarks, copyrights, trade secrets, and other intellectual property. A listing of **onsemi** product/patent coverage may be accessed at [www.onsemi.com/site/pdf/Patent-Marking.pdf](http://www.onsemi.com/site/pdf/Patent-Marking.pdf). **onsemi** reserves the right to make changes at any time to any products or information herein, without notice. The information herein is provided "as-is" and **onsemi** makes no warranty, representation or guarantee regarding the accuracy of the information, product features, availability, functionality, or suitability of its products for any particular purpose, nor does **onsemi** assume any liability arising out of the application or use of any product or circuit, and specifically disclaims any and all liability, including without limitation special, consequential or incidental damages. Buyer is responsible for its products and applications using **onsemi** products, including compliance with all laws, regulations and safety requirements or standards, regardless of any support or applications information provided by **onsemi**. "Typical" parameters which may be provided in **onsemi** data sheets and/or specifications can and do vary in different applications and actual performance may vary over time. All operating parameters, including "Typicals" must be validated for each customer application by customer's technical experts. **onsemi** does not convey any license under any of its intellectual property rights nor the rights of others. **onsemi** products are not designed, intended, or authorized for use as a critical component in life support systems or any FDA Class 3 medical devices or medical devices with a same or similar classification in a foreign jurisdiction or any devices intended for implantation in the human body. Should Buyer purchase or use **onsemi** products for any such unintended or unauthorized application, Buyer shall indemnify and hold **onsemi** and its officers, employees, subsidiaries, affiliates, and distributors harmless against all claims, costs, damages, and expenses, and reasonable attorney fees arising out of, directly or indirectly, any claim of personal injury or death associated with such unintended or unauthorized use, even if such claim alleges that **onsemi** was negligent regarding the design or manufacture of the part. **onsemi** is an Equal Opportunity/Affirmative Action Employer. This literature is subject to all applicable copyright laws and is not for resale in any manner. Other names and brands may be claimed as the property of others.



Is Now Part of



**ON Semiconductor®**

To learn more about ON Semiconductor, please visit our website at

[www.onsemi.com](http://www.onsemi.com)

ON Semiconductor and the ON Semiconductor logo are trademarks of Semiconductor Components Industries, LLC dba ON Semiconductor or its subsidiaries in the United States and/or other countries. ON Semiconductor owns the rights to a number of patents, trademarks, copyrights, trade secrets, and other intellectual property. A listing of ON Semiconductor's product/patent coverage may be accessed at [www.onsemi.com/site/pdf/Patent-Marking.pdf](http://www.onsemi.com/site/pdf/Patent-Marking.pdf). ON Semiconductor reserves the right to make changes without further notice to any products herein. ON Semiconductor makes no warranty, representation or guarantee regarding the suitability of its products for any particular purpose, nor does ON Semiconductor assume any liability arising out of the application or use of any product or circuit, and specifically disclaims any and all liability, including without limitation special, consequential or incidental damages. Buyer is responsible for its products and applications using ON Semiconductor products, including compliance with all laws, regulations and safety requirements or standards, regardless of any support or applications information provided by ON Semiconductor. "Typical" parameters which may be provided in ON Semiconductor data sheets and/or specifications can and do vary in different applications and actual performance may vary over time. All operating parameters, including "Typicals" must be validated for each customer application by customer's technical experts. ON Semiconductor does not convey any license under its patent rights nor the rights of others. ON Semiconductor products are not designed, intended, or authorized for use as a critical component in life support systems or any FDA Class 3 medical devices or medical devices with a same or similar classification in a foreign jurisdiction or any devices intended for implantation in the human body. Should Buyer purchase or use ON Semiconductor products for any such unintended or unauthorized application, Buyer shall indemnify and hold ON Semiconductor and its officers, employees, subsidiaries, affiliates, and distributors harmless against all claims, costs, damages, and expenses, and reasonable attorney fees arising out of, directly or indirectly, any claim of personal injury or death associated with such unintended or unauthorized use, even if such claim alleges that ON Semiconductor was negligent regarding the design or manufacture of the part. ON Semiconductor is an Equal Opportunity/Affirmative Action Employer. This literature is subject to all applicable copyright laws and is not for resale in any manner.

**User Guide for**  
**FEBFSL306LRN\_CS01U02A**  
**Evaluation Board**

**Integrated Controller**  
**FSL306LR**  
**2.05 W Auxiliary Power Supply**

**Featured Fairchild Product:**  
**FSL306LR**

*Direct questions or comments  
about this evaluation board to:  
“Worldwide Direct Support”*

[Fairchild Semiconductor.com](http://Fairchild Semiconductor.com)

## Table of Contents

1. Introduction.....	3
1.1. General Description .....	3
1.2. Features .....	3
2. Specifications .....	4
3. Photographs .....	5
4. PCB Layout.....	6
5. Test Conditions .....	7
6. Performance of Evaluation Board.....	8
6.1. Startup Performance.....	8
6.2. Normal Operation .....	9
6.3. Voltage Stress of Drain and Freewheeling Diode.....	10
6.4. Output Ripple and Noise.....	11
6.5. Step Load Response .....	13
6.6. Output Short Protection .....	15
6.7. Output Line & Load Regulation .....	16
6.8. Temperature Measurement .....	16
6.9. Efficiency Test Result.....	17
6.10. Standby Power Consumption.....	18
6.11. Conducted EMI Measurement .....	19
7. Schematic.....	20
8. Bill of Materials .....	21
9. Revision History .....	22

This user guide supports the evaluation kit for the FSL306LR. It should be used in conjunction with the FSL306LR datasheet as well as Fairchild's application notes and technical support team. Please visit Fairchild's website at [www.fairchildsemi.com](http://www.fairchildsemi.com).

## 1. Introduction

This document is an engineering report describing measured performance of the FSL306LR evaluation board.

### 1.1. General Description

The FSL306LR integrated Pulse Width Modulator (PWM) and SenseFET is specifically designed for high-performance offline buck, buck-boost, and non-isolation flyback Switched Mode Power Supplies (SMPS) with minimal external components. This device integrates a high-voltage power regulator that enables operation without auxiliary bias winding. An internal transconductance amplifier reduces external components for the feedback compensation circuit.

The integrated PWM controller includes: 10 V regulator for no external bias circuit, Under-Voltage Lockout (UVLO), Leading-Edge Blanking (LEB), an optimized gate turn-on / turn-off driver, EMI attenuator, Thermal Shutdown (TSD), temperature-compensated precision current sources for loop compensation, and fault-protection circuitry. Protections include: Overload Protection (OLP), Over-Voltage Protection (OVP), Feedback Open-Loop Protection (FB\_OLP), and Abnormal Over-Current Protection (AOCP). FSL306LR offers good soft-start performance during startup.

The internal high-voltage startup switch and the Burst-Mode operation with very low operating current reduce the power loss in Standby Mode. As the result, it is possible to reach power loss of 120 mW without external bias and 25 mW with external bias when input voltage is 230 V<sub>AC</sub>.

### 1.2. Features

- Built-in Avalanche-Rugged SenseFET: 650 V
- Fixed Operating Frequency: 50 kHz
- No-Load Power Consumption: <25 mW at 230 V<sub>AC</sub> with External Bias; <120 mW at 230 V<sub>AC</sub> without External Bias
- No Need for Auxiliary Bias Winding
- Frequency Modulation for Attenuating EMI
- Pulse-by-Pulse Current Limiting
- Ultra-Low Operating Current: 250 μA
- Built-in Soft-Start and Startup Circuit
- Adjustable Peak Current Limit
- Built-in Transconductance (Error) Amplifier
- Various Protections: Overload Protection (OLP), Over-Voltage Protection (OVP), Feedback Open Loop Protection (FB\_OLP), AOCP (Abnormal Over-Current Protection), Thermal Shutdown (TSD)
- Fixed 650 ms Restart Time for Safe Auto-Restart Mode of All Protections



### 3. Photographs

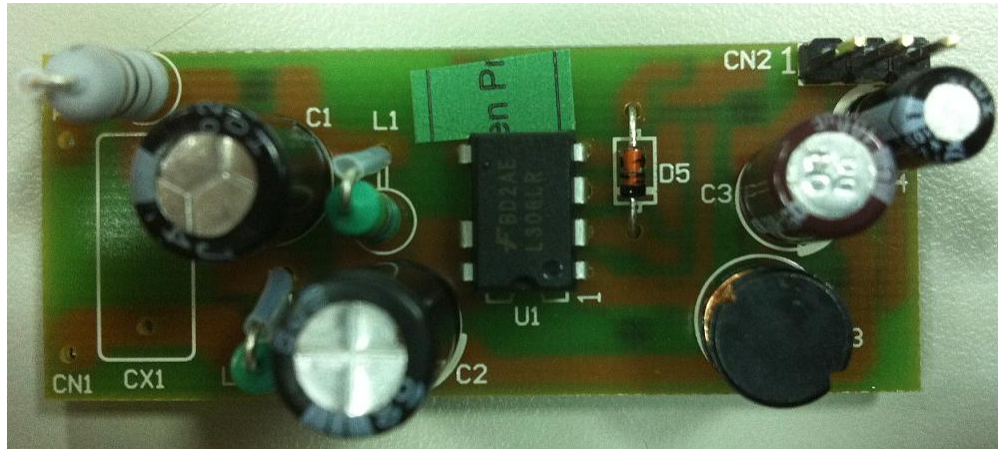


Figure 2. Top View (Dimension 64 x 33 [mm<sup>2</sup>])



Figure 3. Bottom View (Dimension 64 x 33 [mm<sup>2</sup>])

## 4. PCB Layout

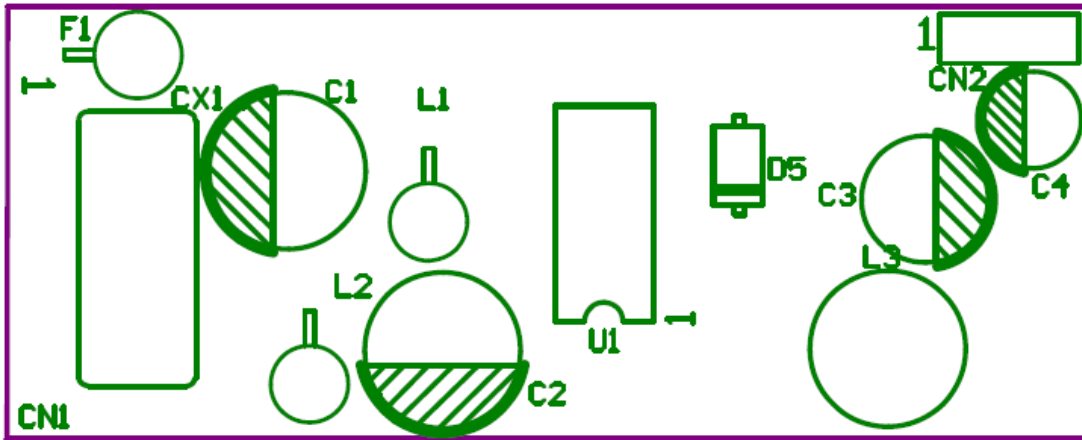


Figure 4. Top Overlay

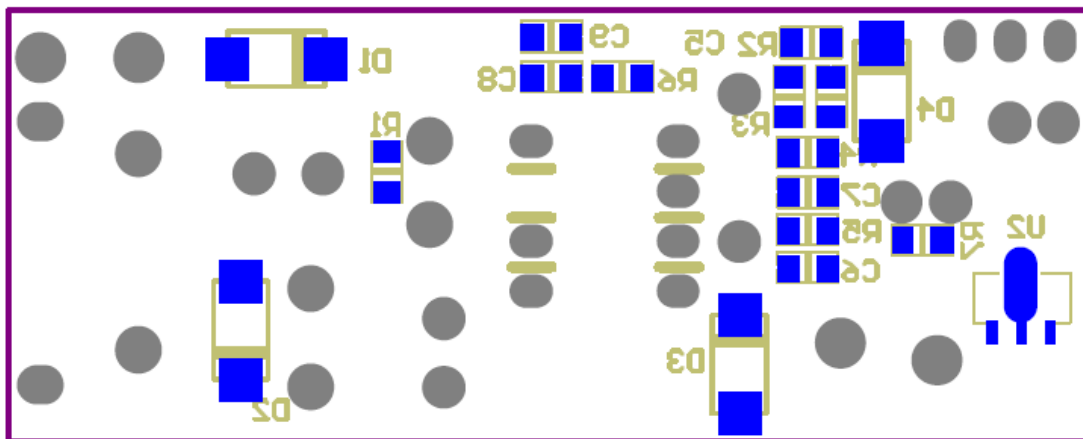


Figure 5. Bottom Overlay

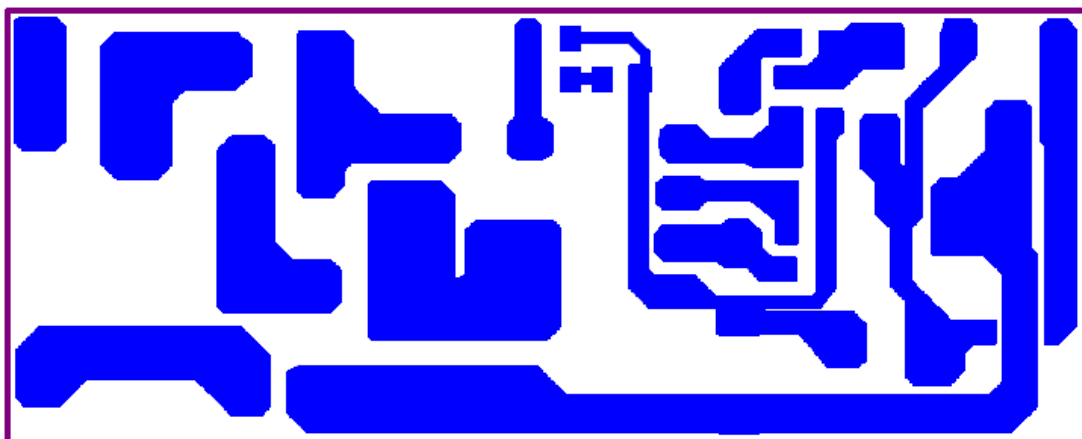


Figure 6. Bottom Layer

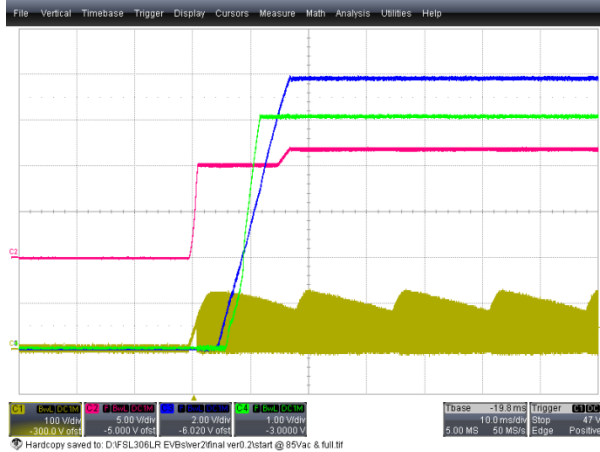


## 5. Test Conditions

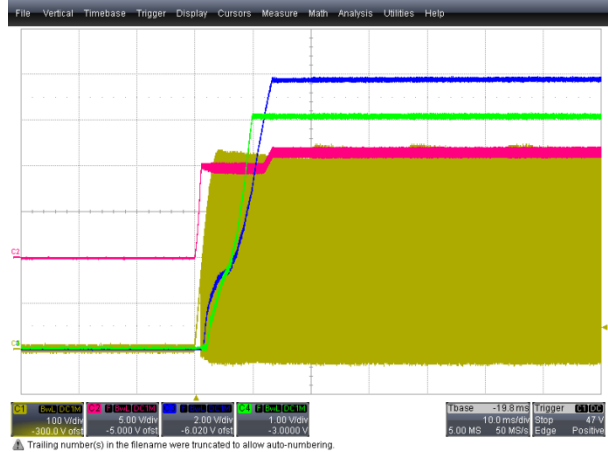
<b>Evaluation Board #</b>	FEBFSL306LRN_CS01U02A
<b>Test Date</b>	April 17, 2013
<b>Test Equipment</b>	AC Source: 6800 Series Electronic Load: Chroma 63030 Oscilloscope: LeCroy 24Xs-A Power Meter: Yokogawa WT210
<b>Test Items</b>	<ol style="list-style-type: none"> <li>1. Startup Performance</li> <li>2. Normal Operation</li> <li>3. Voltage Stress of Drain and Freewheeling Diode</li> <li>4. Output Ripple and Noise</li> <li>5. Step Load Response</li> <li>6. Output Short Protections</li> <li>7. Output Line &amp; Load Regulation</li> <li>8. Temperature Measurement</li> <li>9. Efficiency Test Result</li> <li>10. Standby Power Consumption</li> <li>11. Conducted EMI Measurement</li> </ol>

## 6. Performance of Evaluation Board

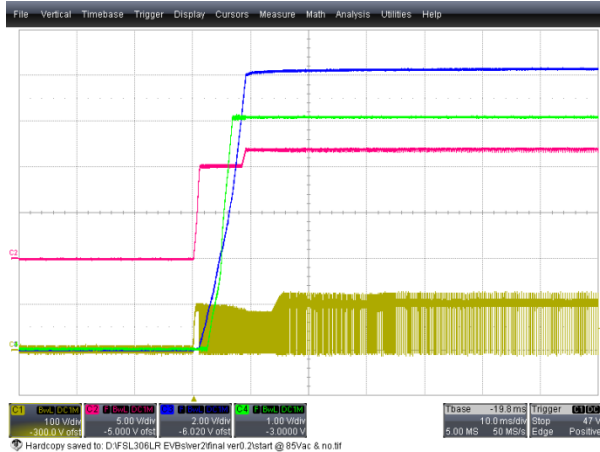
### 6.1. Startup Performance



**Figure 7. Startup Time = 18 ms, 85 V<sub>AC</sub>, Full-Load Condition (CH1: V<sub>DS</sub> (100 V/div), CH2: V<sub>CC</sub> (5 V/div), CH3: 12 V<sub>OUT</sub> (2V/div), CH4: 5 V<sub>OUT</sub> (1 V/div), Time: 10 ms/div)**



**Figure 8. Startup Time = 14 ms, 300 V<sub>AC</sub>, Full-Load Condition (CH1: V<sub>DS</sub> (100 V/div), CH2: V<sub>CC</sub> (5 V/div), CH3: 12 V<sub>OUT</sub> (2 V/div), CH4: 5 V<sub>OUT</sub> (1 V/div), Time: 10 ms/div)**

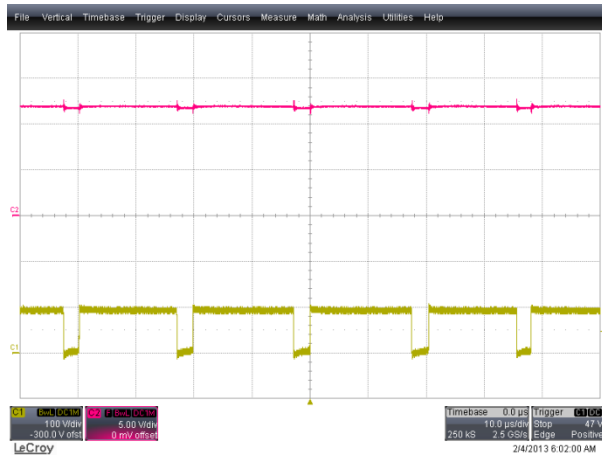


**Figure 9. Startup Time = 10 ms, 85 V<sub>AC</sub>, No-Load Condition (CH1: V<sub>DS</sub> (100 V/div), CH2: V<sub>CC</sub> (5 V/div), CH3: 12 V<sub>OUT</sub> (2 V/div), CH4: 5 V<sub>OUT</sub> (1 V/div), Time: 10 ms/div)**



**Figure 10. Startup Time = 9 ms, 300 V<sub>AC</sub>, No-Load Condition (CH1: V<sub>DS</sub> (100 V/div), CH2: V<sub>CC</sub> (5 V/div), CH3: 12 V<sub>OUT</sub> (2 V/div), CH4: 5 V<sub>OUT</sub> (1 V/div), Time: 10 ms/div)**

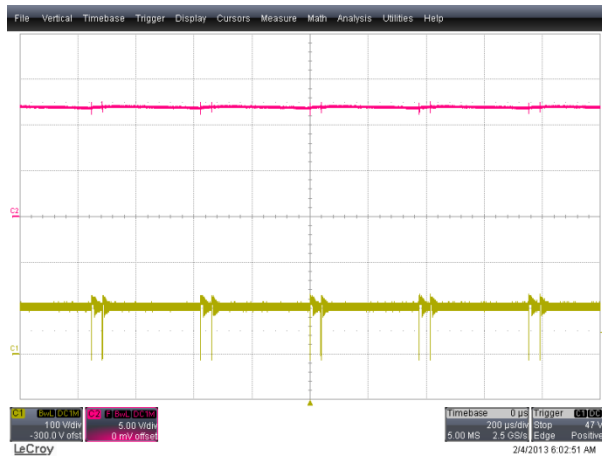
## 6.2. Normal Operation



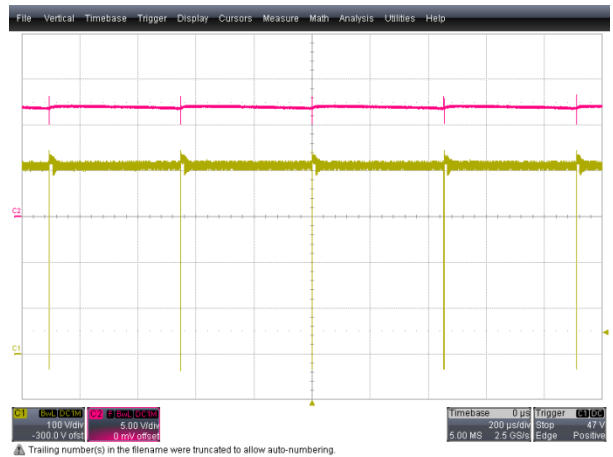
**Figure 11. Full-Load Condition, 85 V<sub>AC</sub>, (CH1: V<sub>DS</sub> (100 V/div), CH2: V<sub>CC</sub> (5 V/div), Time: 10 µs/div)**



**Figure 12. Full-Load Condition, 300 V<sub>AC</sub>, (CH1: V<sub>DS</sub> (100 V/div), CH2: V<sub>CC</sub> (5 V/div), Time: 10 µs/div)**

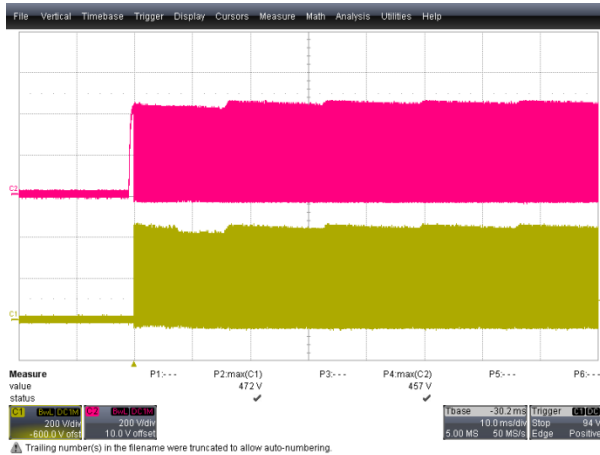


**Figure 13. No-Load Condition, 85 V<sub>AC</sub>, (CH1: V<sub>DS</sub> (100 V/div), CH2: V<sub>CC</sub> (5 V/div), Time: 200 µs/div)**

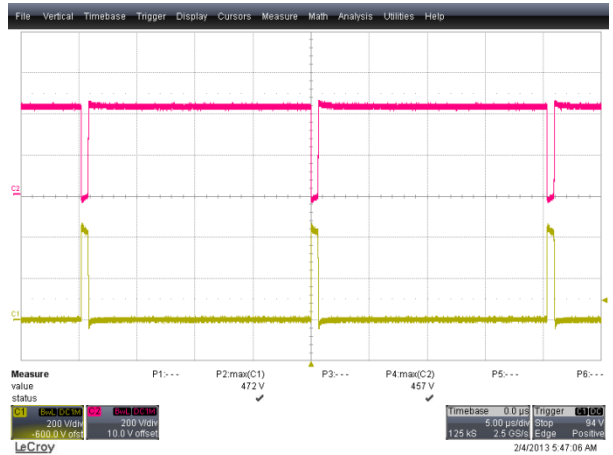


**Figure 14. No-Load Condition, 300 V<sub>AC</sub>, (CH1: V<sub>DS</sub> (100 V/div), CH2: V<sub>CC</sub> (5 V/div), Time: 200 µs/div)**

### 6.3. Voltage Stress of Drain and Freewheeling Diode



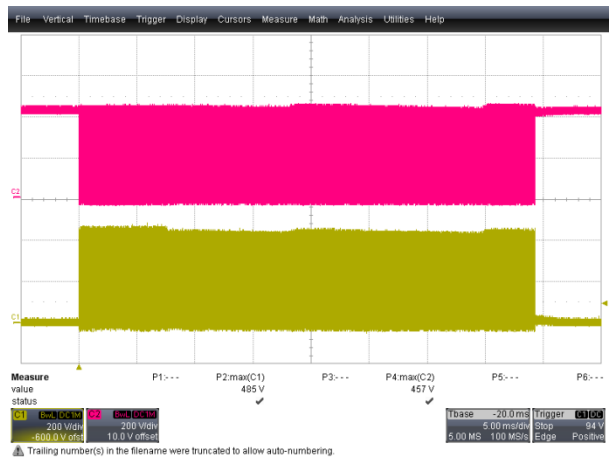
**Figure 15.**  $V_{DS}=457\text{ V}$ ,  $V_{DIODE}=472\text{ V}$ , Startup Condition, Full-Load Condition,  $300\text{ V}_{AC}$ , (CH1:  $V_{DIODE}$  (200 V/div), CH2:  $V_{DS}$  (200 V/div), Time: 10 ms/div)



**Figure 16.**  $V_{DS}=457\text{ V}$ ,  $V_{DIODE}=472\text{ V}$ , Steady-State, Full-Load Condition,  $300\text{ V}_{AC}$ , (CH1:  $V_{DIODE}$  (200 V/div), CH2:  $V_{DS}$  (200 V/div), Time: 5  $\mu\text{s}$ /div)



**Figure 17.**  $V_{DS}=451\text{ V}$  &  $V_{DIODE}=478\text{ V}$ , 12 V Output Short Condition, Full-Load Condition,  $300\text{ V}_{AC}$ , (CH1:  $V_{DIODE}$  (200 V/div), CH2:  $V_{DS}$  (200 V/div), Time: 5 ms/div)



**Figure 18.**  $V_{DS}=457\text{ V}$  &  $V_{DIODE}=485\text{ V}$ , 5 V Output Short Condition, Full-Load Condition,  $300\text{ V}_{AC}$ , (CH1:  $V_{DIODE}$  (200 V/div), CH2:  $V_{DS}$  (200 V/div), Time: 5 ms/div)

## 6.4. Output Ripple and Noise

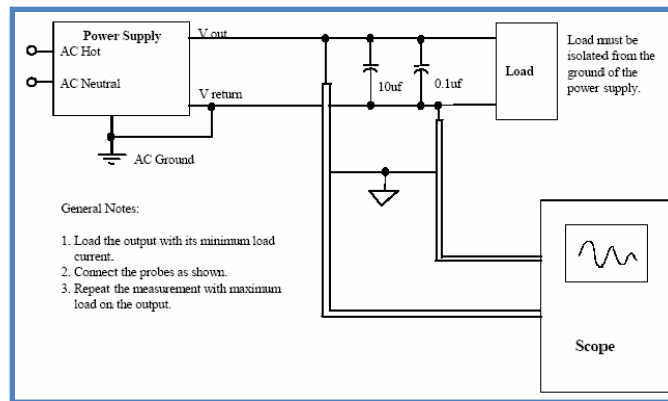


Figure 19. Recommended Test Setup

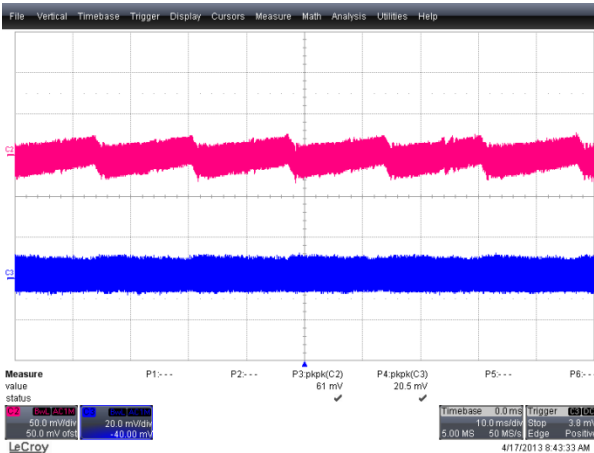


Figure 20.  $12 V_{OUT\_RIPPLE} = 61 \text{ mV}$ ,  $5 V_{OUT\_RIPPLE} = 21 \text{ mV}$ , Output with  $85 V_{AC}$  and Full-Load Condition, CH2:  $12 V_{OUT}$  (50 mV/div), CH3:  $5 V_{OUT}$  (20 mV/div), Time: 10 ms/div

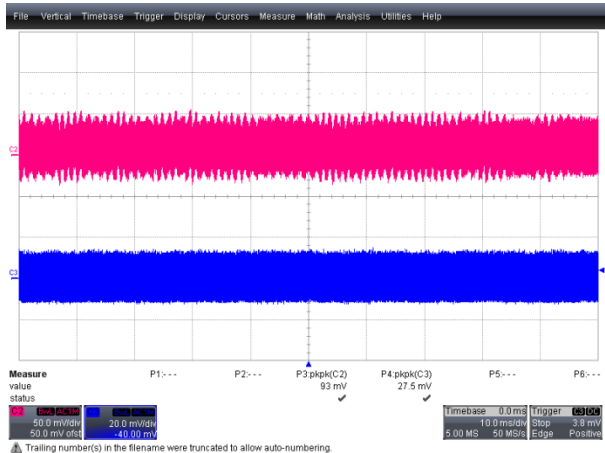


Figure 21.  $12 V_{OUT\_RIPPLE} = 93 \text{ mV}$ ,  $5 V_{OUT\_RIPPLE} = 28 \text{ mV}$ , Output with  $300 V_{AC}$  and Full-Load Condition, CH2:  $12 V_{OUT}$  (50 mV/div), CH3:  $5 V_{OUT}$  (20 mV/div), Time: 10 ms/div

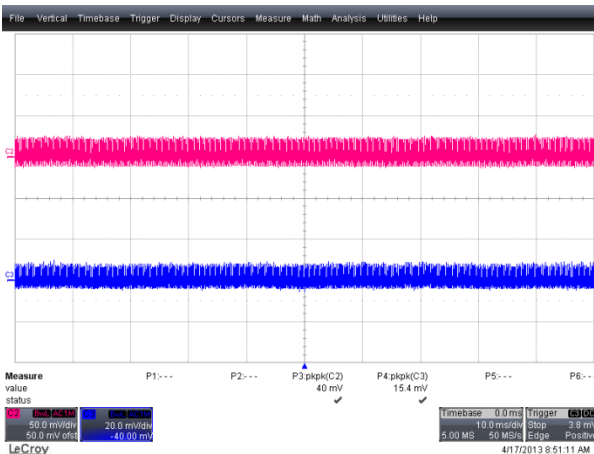


Figure 22.  $12 V_{OUT\_RIPPLE} = 40 \text{ mV}$ ,  $5 V_{OUT\_RIPPLE} = 16 \text{ mV}$ , Output with  $85 V_{AC}$  and No-Load Condition, CH2:  $12 V_{OUT}$  (50 mV/div), CH3:  $5 V_{OUT}$  (20 mV/div), Time: 10 ms/div

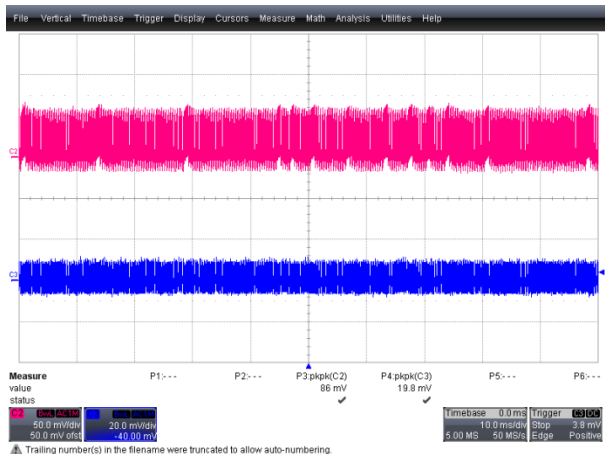
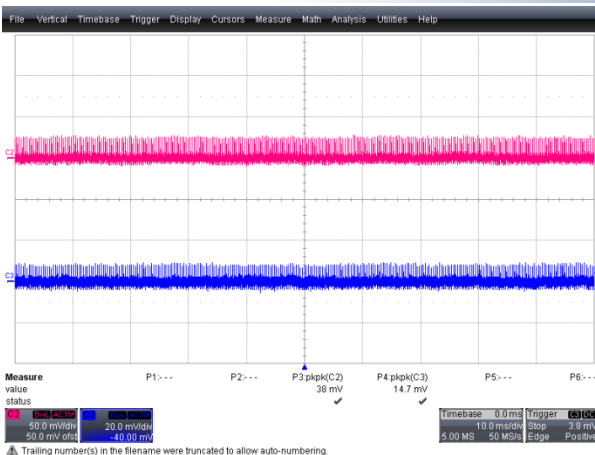
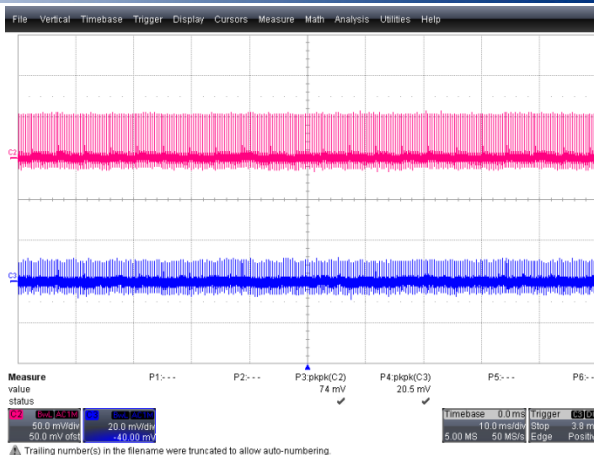


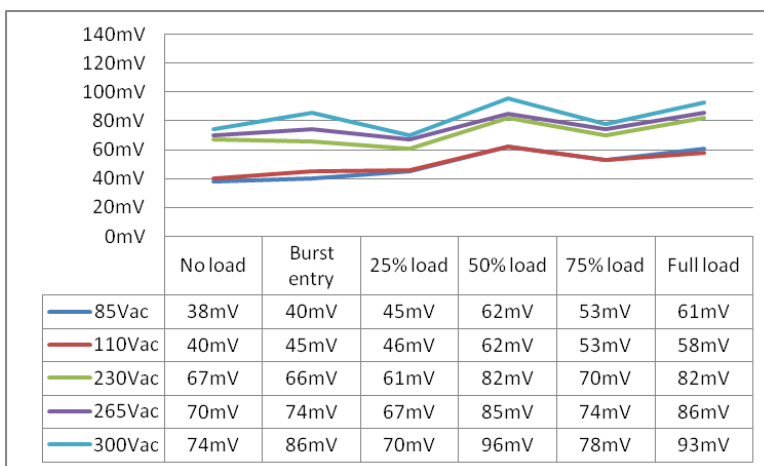
Figure 23.  $12 V_{OUT\_RIPPLE} = 86 \text{ mV}$ ,  $5 V_{OUT\_RIPPLE} = 20 \text{ mV}$ , Output with  $300 V_{AC}$  and No-Load Condition, CH2:  $12 V_{OUT}$  (50 mV/div), CH3:  $5 V_{OUT}$  (20 mV/div), Time: 10 ms/div



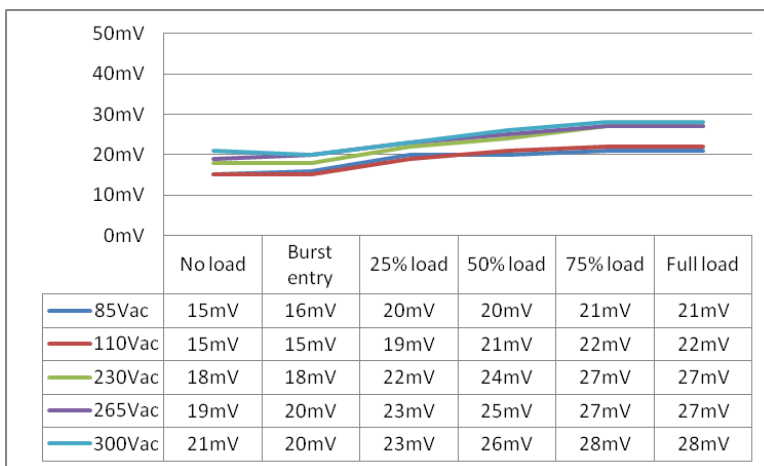
**Figure 24.** 12 V<sub>OUT\_RIPPLE</sub> = 38 mV, 5 V<sub>OUT\_RIPPLE</sub> = 15 mV, Output with 85 V<sub>AC</sub> and Burst-Mode Entry Power, CH2: 12 V<sub>OUT</sub> (50 mV/div), CH3: 5 V<sub>OUT</sub> (20 mV/div), Time: 10 ms/div



**Figure 25.** 12 V<sub>OUT\_RIPPLE</sub> = 74 mV, 5 V<sub>OUT\_RIPPLE</sub> = 21 mV, Output with 300 V<sub>AC</sub> and Burst-Mode Entry Power, CH2: 12 V<sub>OUT</sub> (50 mV/div), CH3: 5 V<sub>OUT</sub> (20 mV/div), Time: 10 ms/div



**Figure 26.** 12 V Output Ripple



**Figure 27.** 5 V Output Ripple

## 6.5. Step Load Response

### Test Slew Rate (250 mA/μs)

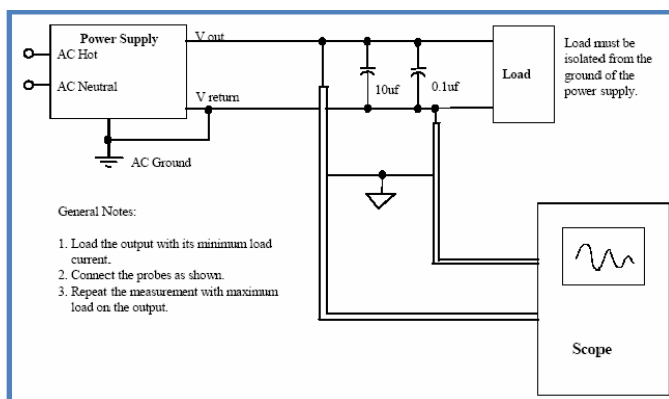


Figure 28. Recommended Test Setup

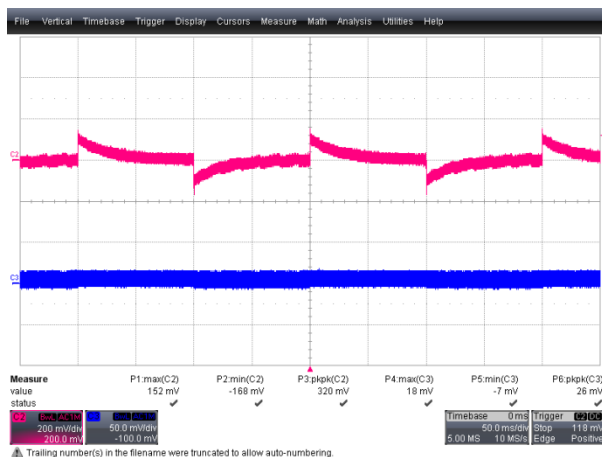


Figure 29. 12 V Output Step Load with 85 V<sub>AC</sub>, 80% Load ↔ 20% Load (CH2: 12 V<sub>OUT</sub> (200 mV/div), CH3: 5 V<sub>OUT</sub> (50 mV/div), Time: 50 ms/div)

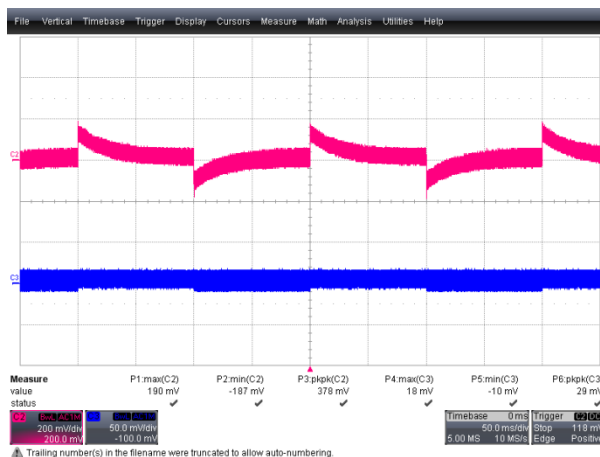


Figure 30. 12 V Output Step Load with 300 V<sub>AC</sub>, 80% Load ↔ 20% load (CH2: 12 V<sub>OUT</sub> (200 mV/div), CH3: 5 V<sub>OUT</sub> (50 mV/div), Time: 50 ms/div)

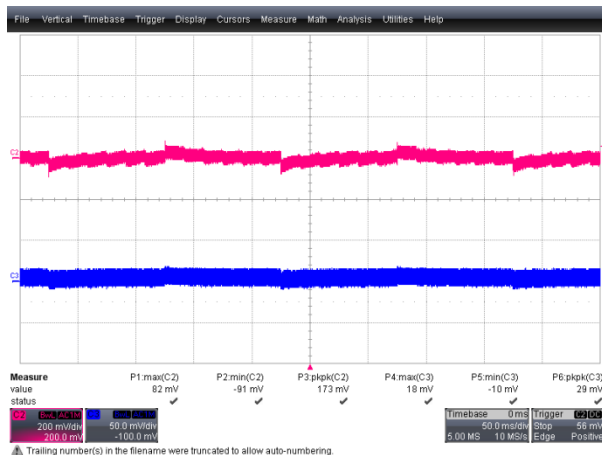


Figure 31. 5 V Output Step Load with 85 V<sub>AC</sub>, 80% Load ↔ 20% Load (CH2: 12 V<sub>OUT</sub> (200 mV/div), CH3: 5 V<sub>OUT</sub> (50 mV/div), Time: 50 ms/div)

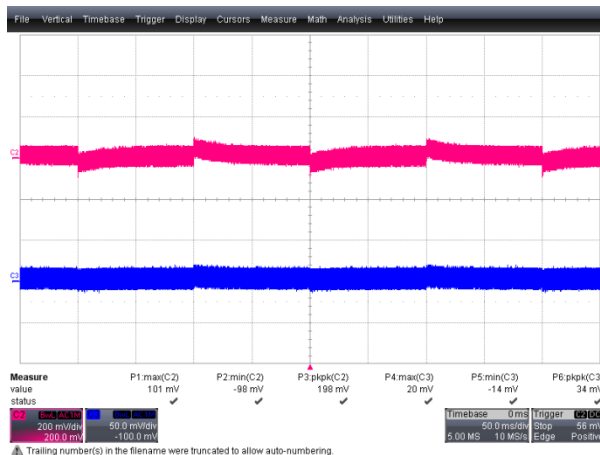


Figure 32. 5 V Output Step Load with 300 V<sub>AC</sub>, 80% Load ↔ 20% load (CH2: 12 V<sub>OUT</sub> (200 mV/div), CH3: 5 V<sub>OUT</sub> (50 mV/div), Time: 50 ms/div)

**Table 2. 12 V Output Step Load Response (5 V Output Full Load Condition)**

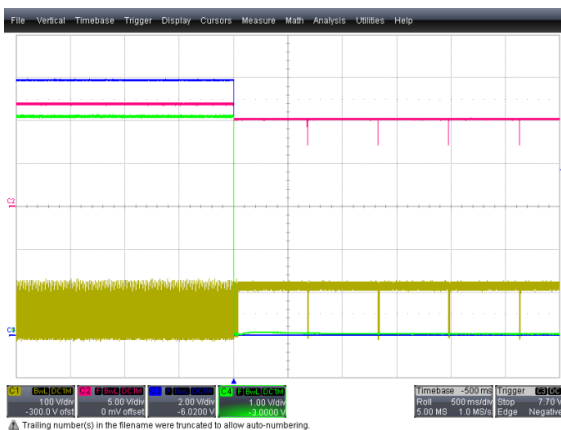
12 V Output Step Load (80% ↔ 20%)		85 V <sub>AC</sub>		110 V <sub>AC</sub>		230 V <sub>AC</sub>		300 V <sub>AC</sub>		300 V <sub>AC</sub>	
		12 V	5 V	12 V	5 V	12 V	5 V	12 V	5 V	12 V	5 V
5 V Full Load	Overshoot	152 mV	18 mV	158 mV	18 mV	178 mV	20 mV	184 mV	20 mV	190 mV	18 mV
	Undershoot	168 mV	7 mV	168 mV	9 mV	187 mV	10 mV	187 mV	10 mV	187 mV	10 mV
	Peak-Peak	320 mV	26 mV	326 mV	27 mV	365 mV	30 mV	371 mV	30 mV	378 mV	29 mV

**Table 3. 5 V Output Step Load Response (12 V Output Full Load Condition)**

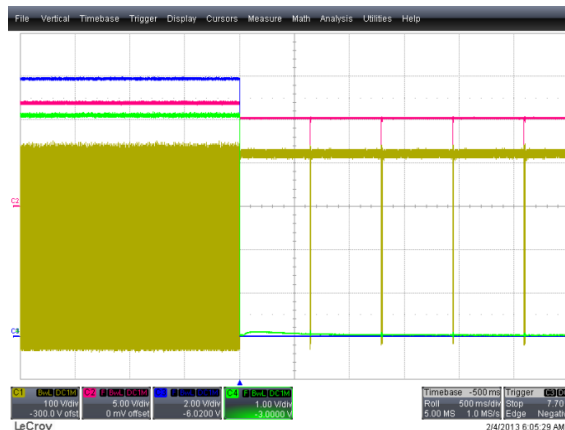
5V Output Step Load (80% ↔ 20%)		85 V <sub>AC</sub>		110 V <sub>AC</sub>		230 V <sub>AC</sub>		300 V <sub>AC</sub>		300 V <sub>AC</sub>	
		12 V	5 V	12 V	5 V	12 V	5 V	12 V	5 V	12 V	5 V
12 V Full Load	Overshoot	82 mV	18 mV	82 mV	20 mV	101 mV	20 mV	101 mV	22 mV	101 mV	20 mV
	Undershoot	91 mV	10 mV	91 mV	10 mV	91 mV	12 mV	91 mV	12 mV	98 mV	14 mV
	Peak-Peak	173 mV	29 mV	173 mV	30 mV	192 mV	32 mV	192 mV	34 mV	198 mV	34 mV



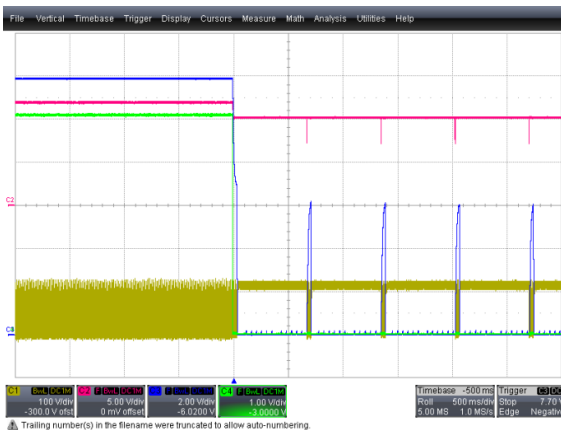
## 6.6. Output Short Protection



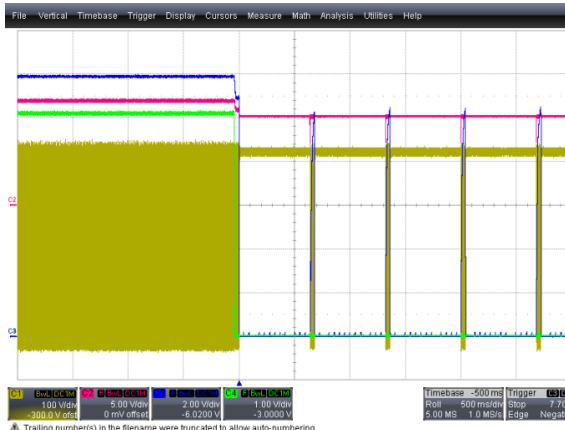
**Figure 33. OLP Triggered, 12 V Output Short with 85 V<sub>AC</sub>, Full-Load, (CH1: V<sub>DS</sub> (100 V/div), CH2: V<sub>CC</sub> (5 V/div), CH3: 12 V<sub>OUT</sub> (2 V/div), CH4: 5 V<sub>OUT</sub> (1 V/div), Time: 500 ms/div)**



**Figure 34. AOCV Triggered, 12 V Output Short with 300 V<sub>AC</sub>, Full-Load, (CH1: V<sub>DS</sub> (100 V/div), CH2: V<sub>CC</sub> (5 V/div), CH3: 12 V<sub>OUT</sub> (2V/div), CH4: 5 V<sub>OUT</sub> (1 V/div), Time: 500 ms/div)**



**Figure 35. OLP Triggered, 5 V Output Short with 85V<sub>AC</sub>, Full-Load, (CH1: V<sub>DS</sub> (100 V/div), CH2: V<sub>CC</sub> (5 V/div), CH3: 12 V<sub>OUT</sub> (2 V/div), CH4: 5 V<sub>OUT</sub> (1 V/div), Time: 500 ms/div)**



**Figure 36. OLP Triggered, 5 V Output Short with 300 V<sub>AC</sub>, Full-Load, (CH1: V<sub>DS</sub> (100 V/div), CH2: V<sub>CC</sub> (5 V/div), CH3: 12 V<sub>OUT</sub> (2 V/div), CH4: 5 V<sub>OUT</sub> (1 V/div), Time: 500 ms/div)**

## 6.7. Output Line & Load Regulation

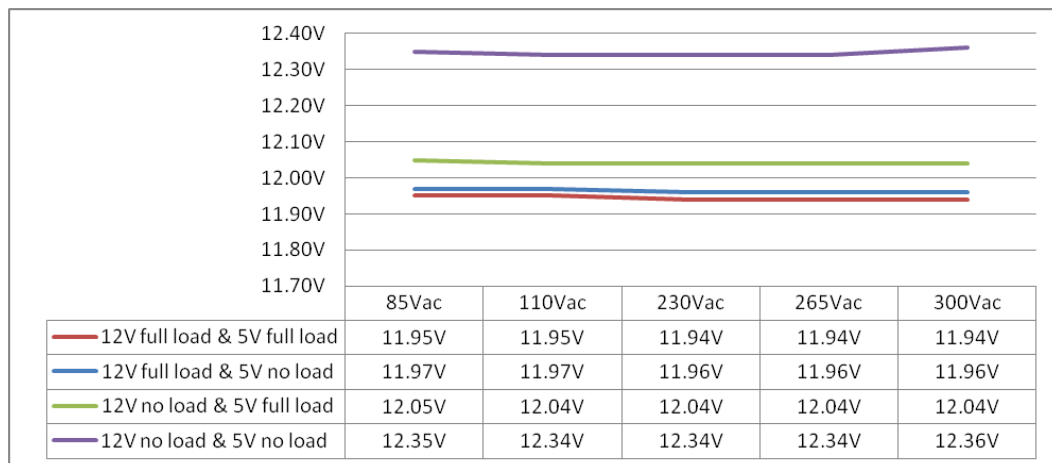


Figure 37. 12 V Output Line & Load Regulation

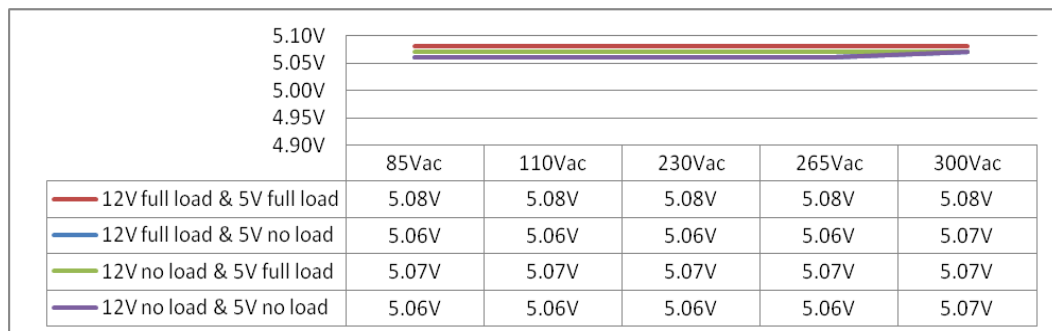


Figure 38. 5 V Output Line & Load Regulation

## 6.8. Temperature Measurement

Table 4. Temperature Test Result

Input Voltage		85 V <sub>AC</sub>	110 V <sub>AC</sub>	230 V <sub>AC</sub>	265 V <sub>AC</sub>	300 V <sub>AC</sub>
Temperature	IC (FSL306LR)	48.0°C	47.0°C	49.0°C	51.0°C	54.0°C
	Freewheeling Diode (ES1J)	57.0°C	58.0°C	61.0°C	62.0°C	63.0°C
	Inductor (PKS0807-681K-TF)	58.0°C	60.0°C	65.0°C	68.0°C	70.0°C
	5 V LDO (KA78L05AI)	67.0°C	69.0°C	71.0°C	71.0°C	72.0°C
Room Temperature		25°C				

## 6.9. Efficiency Test Result

- Test Method:
  - Test after 15 minutes aging
  - Test from heavy load to light load

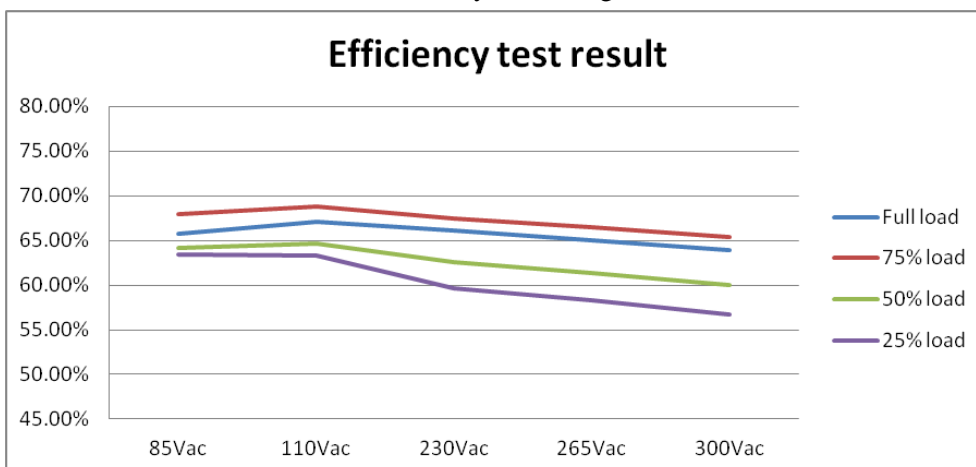


Figure 39. Efficiency vs. Output Load and Input Voltage

Table 5. Efficiency Test Result

		85 V <sub>AC</sub>		110 V <sub>AC</sub>		230 V <sub>AC</sub>		265 V <sub>AC</sub>		300 V <sub>AC</sub>			
		Output 1	Output 2	Pin	Efficiency	Output 1	Output 2	Pin	Efficiency	Output 1	Output 2	Pin	Efficiency
<b>Full Load</b>	Output 1	11.95 V	0.15 A	11.95 V	0.15 A	11.94 V	0.15 A	11.94 V	0.15 A	11.94 V	0.15 A		
	Output 2	5.08 V	0.050 A	5.08 V	0.050 A	5.08 V	0.050 A	5.08 V	0.050 A	5.08 V	0.050 A		
	Pin	3.112 W		3.049 W		3.095 W		3.144 W		3.202 W			
	Efficiency	65.76%		67.12%		66.07%		65.04%		63.87%			
<b>75% Load</b>	Output 1	11.98 V	0.11 A	11.97 V	0.11 A	11.97 V	0.11 A	11.97 V	0.11 A	11.96 V	0.11 A		
	Output 2	5.07 V	0.038 A	5.07 V	0.038 A	5.07 V	0.038 A	5.07 V	0.038 A	5.07 V	0.038 A		
	Pin	2.265 W		2.235 W		2.280 W		2.310 W		2.351 W			
	Efficiency	67.90%		68.76%		67.40%		66.53%		65.32%			
<b>50% Load</b>	Output 1	11.99 V	0.08 A	11.99 V	0.08 A	11.99 V	0.08 A	11.99 V	0.08 A	11.99 V	0.08 A		
	Output 2	5.07 V	0.025 A	5.07 V	0.025 A	5.07 V	0.025 A	5.07 V	0.025 A	5.07 V	0.025 A		
	Pin	1.600 W		1.587 W		1.640 W		1.671 W		1.711 W			
	Efficiency	64.13%		64.65%		62.56%		61.40%		59.96%			
<b>25% Load</b>	Output 1	12.04 V	0.04 A	12.03 V	0.04 A	12.03 V	0.04 A	12.03 V	0.04 A	12.03 V	0.04 A		
	Output 2	5.07 V	0.013 A	5.06 V	0.013 A	5.06 V	0.013 A	5.06 V	0.013 A	5.06 V	0.013 A		
	Pin	0.812 W		0.813 W		0.863 W		0.882 W		0.907 W			
	Efficiency	63.41%		63.27%		59.60%		58.32%		56.71%			

## 6.10. Standby Power Consumption

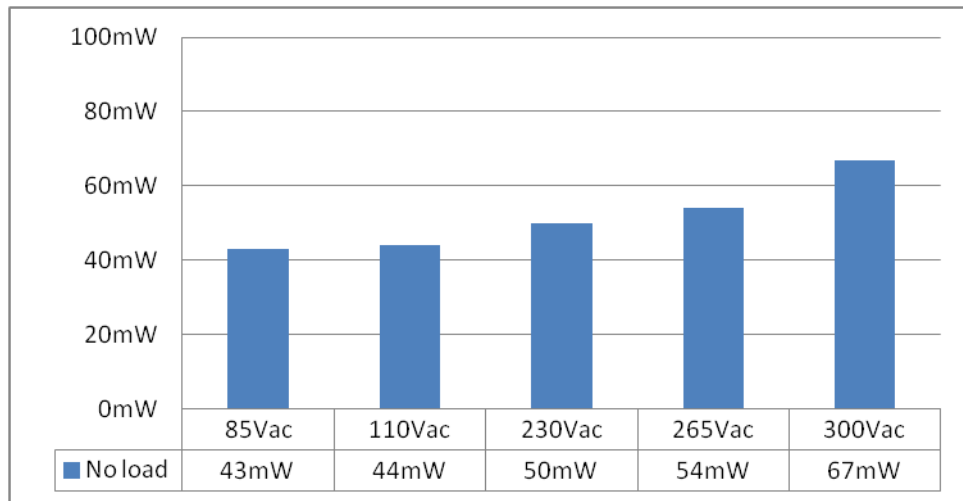
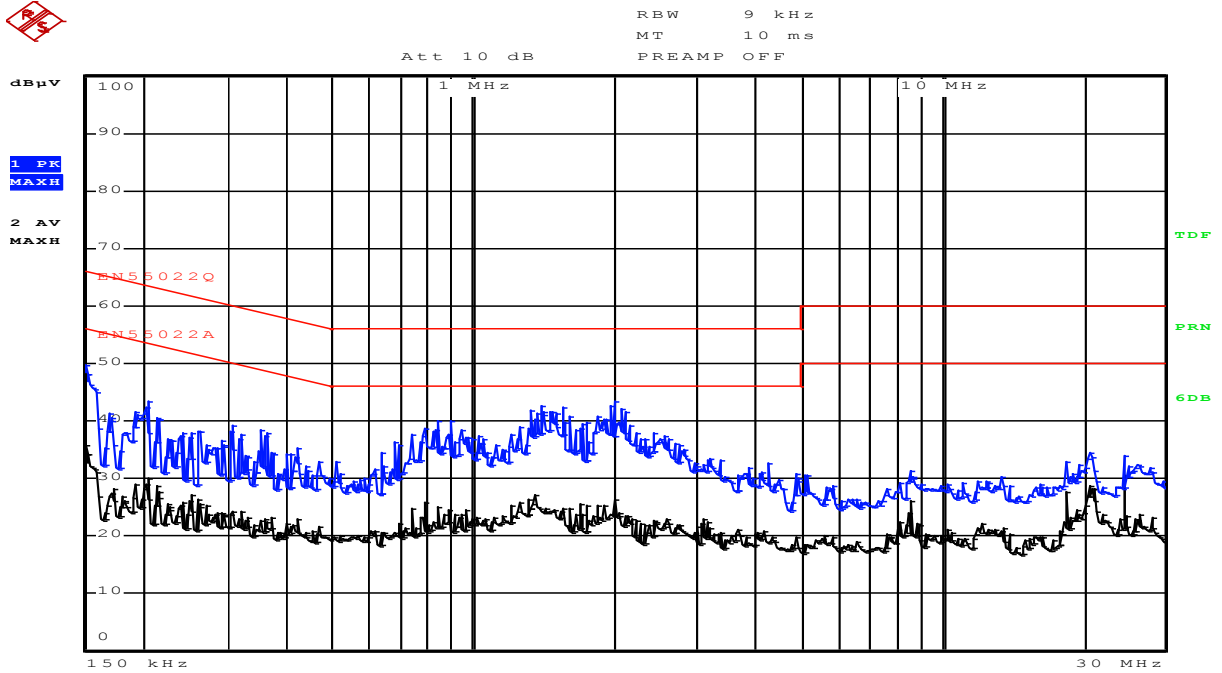


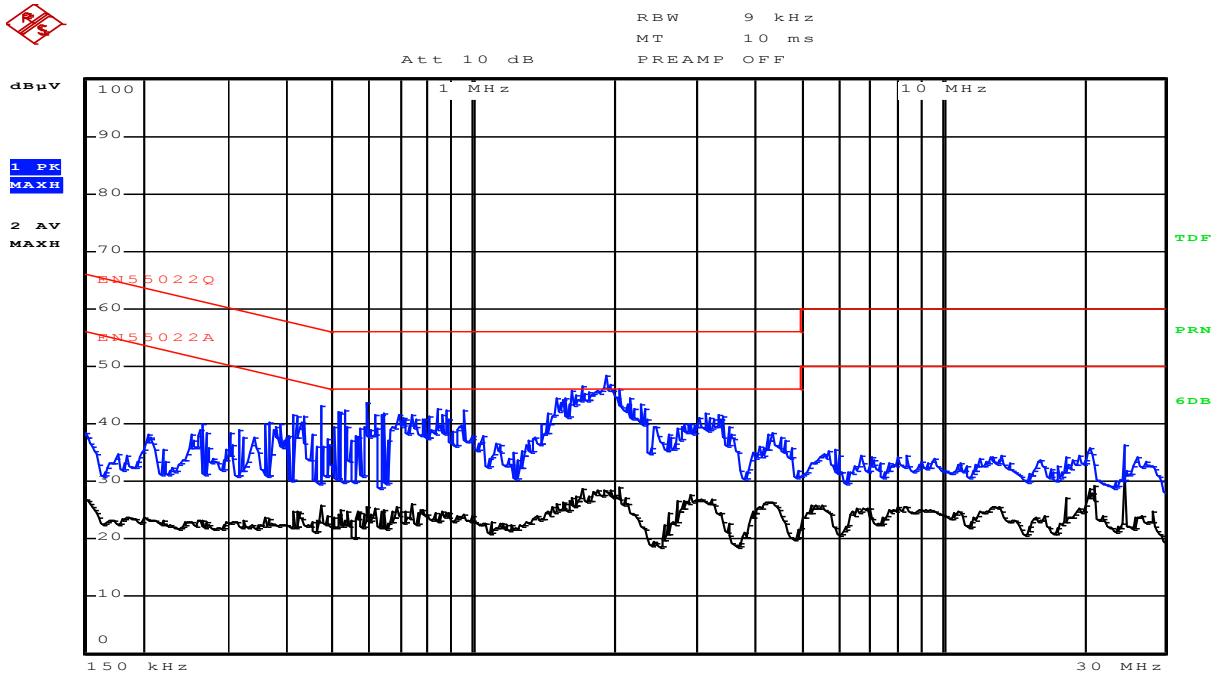
Figure 40. Standby Power Consumption at No Load Condition (Including 5 V Regulator Power Loss)

## 6.11. Conducted EMI Measurement



Date: 18.APR.2013 11:32:43

Figure 41. L at 110 V<sub>AC</sub>



Date: 18.APR.2013 12:05:30

Figure 42. L at 230 V<sub>AC</sub>



## 8. Bill of Materials

Component	Qty.	Part No.	Manufacturer	Reference
Chip Resistor 0805 10 $\Omega$ $\pm$ 5%	1			R2
Chip Resistor 0805 3.3 k $\Omega$ $\pm$ 5%	1			R1
Chip Resistor 0805 5.1 k $\Omega$ $\pm$ 1%	1			R4
Chip Resistor 0805 20 k $\Omega$ $\pm$ 1%	1			R3
Chip Resistor 0805 220 k $\Omega$ $\pm$ 5%	1			R6
0805 MLCC X7R $\pm$ 10% 331P (330 pF) 50 V	1			C9
0805 MLCC X7R $\pm$ 10% 103P (10 nF) 50 V	1			C7
0805 MLCC X7R $\pm$ 10% 224P (220 nF) 50 V	1			C8
0805 MLCC X7R $\pm$ 10% 105P (1 $\mu$ F) 50 V	1			C6
0805 MLCC X7R $\pm$ 10% 225P (2.2 $\mu$ F) 50 V	1			C5
Electrolytic Capacitor 4.7 $\mu$ F 400 V 105°C	1	LHK General Purpose	JACKCON	C1
Electrolytic Capacitor 6.8 $\mu$ F 400 V 105°C	1	KM(M)	SAMXON	C2
Electrolytic Capacitor 47 $\mu$ F 25 V 105°C	1	LHK General Purpose	JACKCON	C4
Electrolytic Capacitor 100 $\mu$ F 25 V 105°C	1	KY		C3
Fixed Inductor 470 $\mu$ H $\pm$ 10%	2	EC36-471K	SYNTON	L1, L2
Inductor DR8X7 680 $\mu$ H	1	PKS0807-681K-TF	3L Electronic	L3
General Diode 1 A / 1000 V SMA	2	S1M	Fairchild Semiconductor	D1, D2
Super Fast Diode 1 A / 600 V SMA	2	ES1J	Fairchild Semiconductor	D3, D4
Diode DO-35 300 mA / 100 V	1	1N4148	Fairchild Semiconductor	D5
IC Positive Voltage Regulator	1	KA78L05AIMTF	Fairchild Semiconductor	U2
IC SMPS Power Switch	1	FSL306LR	Fairchild Semiconductor	U1
Wire Wound Resistor 1 W 10R $\pm$ 5%	1			F1

## 9. Revision History

Rev.	Date	Description
1.0.0	4/2013	Initial release

---

### WARNING AND DISCLAIMER

Replace components on the Evaluation Board only with those parts shown on the parts list (or Bill of Materials) in the Users' Guide. Contact an authorized Fairchild representative with any questions.

This board is intended to be used by certified professionals, in a lab environment, following proper safety procedures. Use at your own risk. The Evaluation board (or kit) is for demonstration purposes only and neither the Board nor this User's Guide constitute a sales contract or create any kind of warranty, whether express or implied, as to the applications or products involved. Fairchild warrants that its products meet Fairchild's published specifications, but does not guarantee that its products work in any specific application. Fairchild reserves the right to make changes without notice to any products described herein to improve reliability, function, or design. Either the applicable sales contract signed by Fairchild and Buyer or, if no contract exists, Fairchild's standard Terms and Conditions on the back of Fairchild invoices, govern the terms of sale of the products described herein.

#### DISCLAIMER

FAIRCHILD SEMICONDUCTOR RESERVES THE RIGHT TO MAKE CHANGES WITHOUT FURTHER NOTICE TO ANY PRODUCTS HEREIN TO IMPROVE RELIABILITY, FUNCTION, OR DESIGN. FAIRCHILD DOES NOT ASSUME ANY LIABILITY ARISING OUT OF THE APPLICATION OR USE OF ANY PRODUCT OR CIRCUIT DESCRIBED HEREIN; NEITHER DOES IT CONVEY ANY LICENSE UNDER ITS PATENT RIGHTS, NOR THE RIGHTS OF OTHERS.

#### LIFE SUPPORT POLICY

FAIRCHILD'S PRODUCTS ARE NOT AUTHORIZED FOR USE AS CRITICAL COMPONENTS IN LIFE SUPPORT DEVICES OR SYSTEMS WITHOUT THE EXPRESS WRITTEN APPROVAL OF THE PRESIDENT OF FAIRCHILD SEMICONDUCTOR CORPORATION.

---

As used herein:

1. Life support devices or systems are devices or systems which, (a) are intended for surgical implant into the body, or (b) support or sustain life, or (c) whose failure to perform when properly used in accordance with instructions for use provided in the labeling, can be reasonably expected to result in significant injury to the user.
2. A critical component is any component of a life support device or system whose failure to perform can be reasonably expected to cause the failure of the life support device or system, or to affect its safety or effectiveness.

---

### ANTI-COUNTERFEITING POLICY

Fairchild Semiconductor Corporation's Anti-Counterfeiting Policy. Fairchild's Anti-Counterfeiting Policy is also stated on our external website, [www.fairchildsemi.com](http://www.fairchildsemi.com), under Sales Support.

Counterfeiting of semiconductor parts is a growing problem in the industry. All manufacturers of semiconductor products are experiencing counterfeiting of their parts. Customers who inadvertently purchase counterfeit parts experience many problems such as loss of brand reputation, substandard performance, failed applications, and increased cost of production and manufacturing delays. Fairchild is taking strong measures to protect ourselves and our customers from the proliferation of counterfeit parts. Fairchild strongly encourages customers to purchase Fairchild parts either directly from Fairchild or from Authorized Fairchild Distributors who are listed by country on our web page cited above. Products customers buy either from Fairchild directly or from Authorized Fairchild Distributors are genuine parts, have full traceability, meet Fairchild's quality standards for handling and storage and provide access to Fairchild's full range of up-to-date technical and product information. Fairchild and our Authorized Distributors will stand behind all warranties and will appropriately address any warranty issues that may arise. Fairchild will not provide any warranty coverage or other assistance for parts bought from Unauthorized Sources. Fairchild is committed to combat this global problem and encourage our customers to do their part in stopping this practice by buying direct or from authorized distributors.

---

### EXPORT COMPLIANCE STATEMENT

These commodities, technology, or software were exported from the United States in accordance with the Export Administration Regulations for the ultimate destination listed on the commercial invoice. Diversion contrary to U.S. law is prohibited.

U.S. origin products and products made with U.S. origin technology are subject to U.S. Re-export laws. In the event of re-export, the user will be responsible to ensure the appropriate U.S. export regulations are followed.



ON Semiconductor and  are trademarks of Semiconductor Components Industries, LLC dba ON Semiconductor or its subsidiaries in the United States and/or other countries. ON Semiconductor owns the rights to a number of patents, trademarks, copyrights, trade secrets, and other intellectual property. A listing of ON Semiconductor's product/patent coverage may be accessed at [www.onsemi.com/site/pdf/Patent-Marking.pdf](http://www.onsemi.com/site/pdf/Patent-Marking.pdf). ON Semiconductor reserves the right to make changes without further notice to any products herein. ON Semiconductor makes no warranty, representation or guarantee regarding the suitability of its products for any particular purpose, nor does ON Semiconductor assume any liability arising out of the application or use of any product or circuit, and specifically disclaims any and all liability, including without limitation special, consequential or incidental damages. Buyer is responsible for its products and applications using ON Semiconductor products, including compliance with all laws, regulations and safety requirements or standards, regardless of any support or applications information provided by ON Semiconductor. "Typical" parameters which may be provided in ON Semiconductor data sheets and/or specifications can and do vary in different applications and actual performance may vary over time. All operating parameters, including "Typicals" must be validated for each customer application by customer's technical experts. ON Semiconductor does not convey any license under its patent rights nor the rights of others. ON Semiconductor products are not designed, intended, or authorized for use as a critical component in life support systems or any FDA Class 3 medical devices or medical devices with a same or similar classification in a foreign jurisdiction or any devices intended for implantation in the human body. Should Buyer purchase or use ON Semiconductor products for any such unintended or unauthorized application, Buyer shall indemnify and hold ON Semiconductor and its officers, employees, subsidiaries, affiliates, and distributors harmless against all claims, costs, damages, and expenses, and reasonable attorney fees arising out of, directly or indirectly, any claim of personal injury or death associated with such unintended or unauthorized use, even if such claim alleges that ON Semiconductor was negligent regarding the design or manufacture of the part. ON Semiconductor is an Equal Opportunity/Affirmative Action Employer. This literature is subject to all applicable copyright laws and is not for resale in any manner.

## PUBLICATION ORDERING INFORMATION

### LITERATURE FULFILLMENT:

Literature Distribution Center for ON Semiconductor  
19521 E. 32nd Pkwy, Aurora, Colorado 80011 USA  
**Phone:** 303-675-2175 or 800-344-3860 Toll Free USA/Canada  
**Fax:** 303-675-2176 or 800-344-3867 Toll Free USA/Canada  
**Email:** [orderlit@onsemi.com](mailto:orderlit@onsemi.com)

**N. American Technical Support:** 800-282-9855 Toll Free  
USA/Canada  
**Europe, Middle East and Africa Technical Support:**  
Phone: 421 33 790 2910  
**Japan Customer Focus Center**  
Phone: 81-3-5817-1050

**ON Semiconductor Website:** [www.onsemi.com](http://www.onsemi.com)  
**Order Literature:** <http://www.onsemi.com/orderlit>  
For additional information, please contact your local  
Sales Representative