

Low-Voltage 16-Bit Buffer/Line Driver with 3.6 V Tolerant Inputs and Outputs and 26 Ω Series Resistor in Outputs

74ALVC162244

General Description

The ALVC162244 contains sixteen non-inverting buffers with 3-STATE outputs to be employed as a memory and address driver, clock driver, or bus oriented transmitter/receiver. The device is nibble (4-bit) controlled. Each nibble has separate 3-STATE control inputs which can be shorted together for full 16-bit operation.

The 74ALVC162244 is designed for low voltage (1.65 V to 3.6 V) V_{CC} applications with I/O capability up to 3.6 V. The 74ALVC162244 is also designed with 26 Ω series resistors in the outputs. This design reduces line noise in applications such as memory address drivers, clock drivers, and bus transceivers/transmitters.

The 74ALVC162244 is fabricated with an advanced CMOS technology to achieve high speed operation while maintaining low CMOS power dissipation.

Features

- 1.65 V to 3.6 V V_{CC} Supply Operation
- 3.6 V Tolerant Inputs and Outputs
- 26 Ω Series Resistors in Outputs
- t_{PD}
 - ◆ 3.8 ns max for 3.0 V to 3.6 V V_{CC}
 - ◆ 4.3 ns max for 2.3 V to 2.7 V V_{CC}
 - ◆ 7.6 ns max for 1.65 V to 1.95 V V_{CC}
- Power-off High Impedance Inputs and Outputs
- Supports Live Insertion and Withdrawal*
- Uses Patented Noise/EMI Reduction Circuitry
- Latch-up conforms to JEDEC JED78
- ESD Performance:
 - ◆ Human Body Model >2000 V
 - ◆ Machine Model >200 V
- These Devices are Pb-Free, Halide Free and are RoHS Compliant

*To ensure the high-impedance state during power up or power down, \overline{OE} should be tied to V_{CC} through a pull-up resistor; the minimum value of the resistor is determined by the current-sourcing capability of the driver.

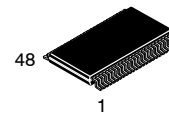

TSSOP48 12.5x6.1
CASE 948BQ

MARKING DIAGRAM

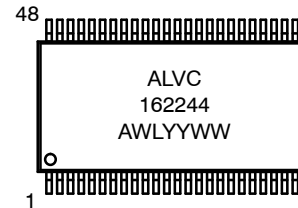

- A = Assembly Location
- WL = Wafer Lot
- YY = Year
- WW = Work Week

ORDERING INFORMATION

See detailed ordering and shipping information in the package dimensions section on page 5 of this data sheet.

74ALVC162244

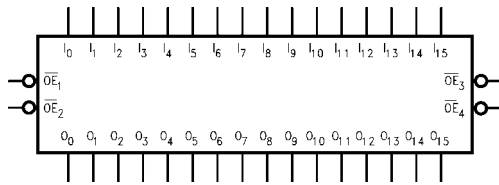

Figure 1. Logic Symbol

Connection Diagram

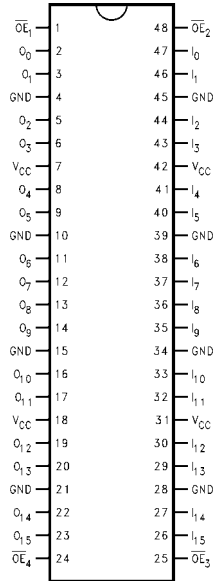

Figure 2. Pin Assignment for TSSOP

PIN DESCRIPTION

Pin Names	Description
\overline{OE}_n	Output Enable Input (Active LOW)
I_0-I_{15}	Inputs
O_0-O_{15}	Outputs
NC	No Connect

TRUTH TABLE

Inputs		Outputs
\overline{OE}_1	I_0-I_3	O_0-O_3
L	L	L
L	H	H
H	X	Z

\overline{OE}_2	I_4-I_7	O_4-O_7
L	L	L
L	H	H
H	X	Z

\overline{OE}_3	I_8-I_{11}	O_8-O_{11}
L	L	L
L	H	H
H	X	Z

\overline{OE}_4	$I_{12}-I_{15}$	$O_{12}-O_{15}$
L	L	L
L	H	H
H	X	Z

H = HIGH Voltage Level

L = LOW Voltage Level

X = Immaterial (HIGH or LOW, inputs may not float)

Z = High Impedance

Functional Description

The 74ALVC162244 contains sixteen non-inverting buffers with 3-STATE outputs. The device is nibble (4 bits) controlled with each nibble functioning identically, but independent of each other. The control pins may be shorted together to obtain full 16-bit operation. The 3-STATE outputs are controlled by an Output Enable (\overline{OE}_n) input. When \overline{OE}_n is LOW, the outputs are in the 2-state mode. When \overline{OE}_n is HIGH, the standard outputs are in the high impedance mode but this does not interfere with entering new data into the inputs.

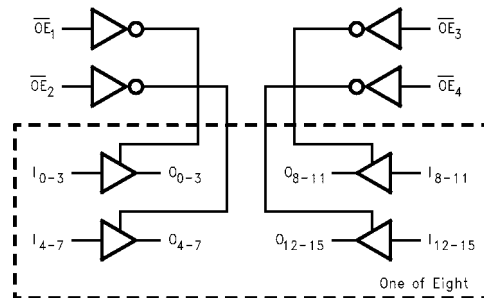

Figure 3. Logic Diagram

ABSOLUTE MAXIMUM RATINGS

Parameter	Symbol	Value	Unit
Supply Voltage	V_{CC}	-0.5 to 4.6	V
DC Input Voltage	V_I	-0.5 to 4.6	V
Output Voltage (Note 1)	V_O	-0.5 to $V_{CC} + 0.5$	V
DC Input Diode Current, $V_I < 0$ V	I_{IK}	-50	mA
DC Output Diode Current, $V_O < 0$ V	I_{OK}	-50	mA
DC Output Source/Sink Current	I_{OH}/I_{OL}	± 50	mA
DC V_{CC} or GND Current per Supply Pin	I_{CC} or GND	± 100	mA
Storage Temperature Range	T_{STG}	-65 to +150	$^{\circ}\text{C}$

Stresses exceeding those listed in the Maximum Ratings table may damage the device. If any of these limits are exceeded, device functionality should not be assumed, damage may occur and reliability may be affected.

1. I_O Absolute Maximum Rating must be observed.

RECOMMENDED OPERATING CONDITIONS (Note 2)

Symbol	Parameter	Min	Max	Unit
V_{CC}	Power Supply Operating Voltage	1.65	3.6	V
V_I	Input Voltage	0	V_{CC}	V
V_O	Output Voltage	0	V_{CC}	V
T_A	Free Air Operating Temperature	-40	85	$^{\circ}\text{C}$
$\Delta t/\Delta V$	Input Edge Rate, $V_{IN} = 0.8$ V to 2.0 V, $V_{CC} = 3.0$ V	0	10	ns/V

Functional operation above the stresses listed in the Recommended Operating Ranges is not implied. Extended exposure to stresses beyond the Recommended Operating Ranges limits may affect device reliability.

2. Floating or unused control inputs must be held HIGH or LOW.

DC ELECTRICAL CHARACTERISTICS

Symbol	Parameter	Conditions	V _{CC} (V)	Min	Max	Units
V _{IH}	HIGH Level Input Voltage		1.65 – 1.95 2.3 – 2.7 2.7 – 3.6	0.65 x V _{CC} 1.7 2.0		V
V _{IL}	LOW Level Input Voltage		1.65 – 1.95 2.3 – 2.7 2.7 – 3.6		0.35 x V _{CC} 0.7 0.8	V
V _{OH}	HIGH Level Output Voltage	I _{OH} = -100 μA	1.65 – 3.6	V _{CC} - 0.2		V
		I _{OH} = -2 mA	1.65	1.2		
		I _{OH} = -4 mA	2.3	1.9		
		I _{OH} = -6 mA	2.3 3	1.7 2.4		
		I _{OH} = -8 mA	2.7	2		
		I _{OH} = -12 mA	3.0	2		
V _{OL}	LOW Level Output Voltage	I _{OL} = 100 μA	1.65 – 3.6		0.2	V
		I _{OL} = 2 mA	1.65		0.45	
		I _{OL} = 4 mA	2.3		0.4	
		I _{OL} = 6 mA	2.3 3		0.55 0.55	
		I _{OL} = 8 mA	2.7		0.6	
		I _{OL} = 12 mA	3		0.8	
I _I	Input Leakage Current	0 ≤ V _I ≤ 3.6 V	3.6		±5.0	μA
I _{OZ}	3-STATE Output Leakage	0 ≤ V _O ≤ 3.6 V	3.6		±10	μA
I _{CC}	Quiescent Supply Current	V _I = V _{CC} or GND, I _O = 0	3.6		40	μA
ΔI _{CC}	Increase in I _{CC} per Input	V _{IH} = V _{CC} - 0.6 V	3 – 3.6		750	μA

AC ELECTRICAL CHARACTERISTICS

Symbol	Parameter	T _A = -40°C to +85°C, R _L = 500 Ω								Units
		C _L = 50 pF				C _L = 30 pF				
		V _{CC} = 3.3 V ±0.3 V		V _{CC} = 2.7 V		V _{CC} = 2.5 V ±0.2 V		V _{CC} = 1.8 V ±0.15 V		
		Min	Max	Min	Max	Min	Max	Min	Max	
t _{PHL} , t _{PLH}	Propagation Delay	1.3	3.8	1.5	4.3	1.0	3.8	1.5	7.6	ns
t _{PZL} , t _{PZH}	Output Enable Time	1.3	4.3	1.5	5.6	1.0	5.1	1.5	9.8	ns
t _{PLZ} , t _{PHZ}	Output Disable Time	1.3	4.1	1.5	4.5	1.0	4.0	1.5	7.2	ns

CAPACITANCE

Symbol	Parameter	Conditions	T _A = +25°C		Units
			V _{CC}	Typical	
C _{IN}	Input Capacitance	V _I = 0 V or V _{CC}	3.3	6	pF
C _{OUT}	Output Capacitance	V _I = 0 V or V _{CC}	3.3	7	pF
C _{PD}	Power Dissipation Capacitance	Outputs Enabled f = 10 MHz, C _L = 50 pF	3.3	20	pF
			2.5	20	

74ALVC162244

AC Loading and Waveforms

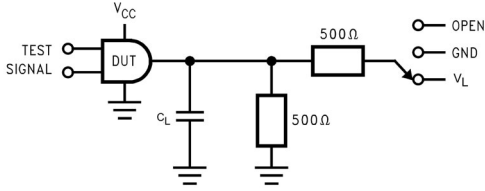

Figure 4. AC Test Circuit

Values for Figure 4

Test	Switch
t_{PLH} , t_{PHL}	Open
t_{PZL} , t_{PLZ}	V_L
t_{PZH} , t_{PHZ}	GND

VARIABLE MATRIX

(Input Characteristics: $f = t_r = t_f = 2 \text{ ns}$; $Z_0 = 50 \Omega$)

Symbol	V_{CC}			
	3.3 V ± 0.3 V	2.7 V	2.5 V ± 0.2 V	1.8 V ± 0.15 V
V_{mi}	1.5 V	1.5 V	$V_{CC} / 2$	$V_{CC} / 2$
V_{mo}	1.5 V	1.5 V	$V_{CC} / 2$	$V_{CC} / 2$
V_X	$V_{OL} + 0.3 \text{ V}$	$V_{OL} + 0.3 \text{ V}$	$V_{OL} + 0.15 \text{ V}$	$V_{OL} + 0.15 \text{ V}$
V_Y	$V_{OH} - 0.3 \text{ V}$	$V_{OH} - 0.3 \text{ V}$	$V_{OH} - 0.15 \text{ V}$	$V_{OH} - 0.15 \text{ V}$
V_L	6 V	6 V	$V_{CC} * 2$	$V_{CC} * 2$

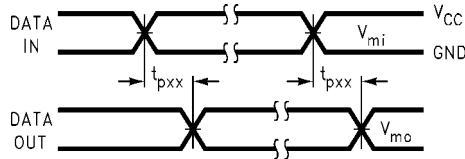

Figure 5. Waveform for Inverting and Non-Inverting Functions

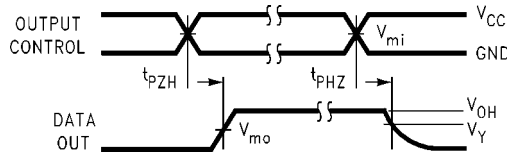

Figure 6. 3-STATE Output High Enable and Disable Times for Low Voltage Logic

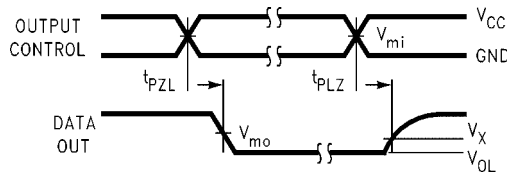

Figure 7. 3-STATE Output Low Enable and Disable Times for Low Voltage Logic

ORDERING INFORMATION

Device	Package	Shipping [†]
74ALVC162244TX	TSSOP48 12.5x6.1 (Pb-Free)	1000 Units / Tape & Reel

[†]For information on tape and reel specifications, including part orientation and tape sizes, please refer to our Tape and Reel Packaging Specifications Brochure, BRD8011/D.

MECHANICAL CASE OUTLINE

PACKAGE DIMENSIONS

ON Semiconductor®



TSSOP48 12.5x6.1
CASE 948BQ
ISSUE O

DATE 30 SEP 2016

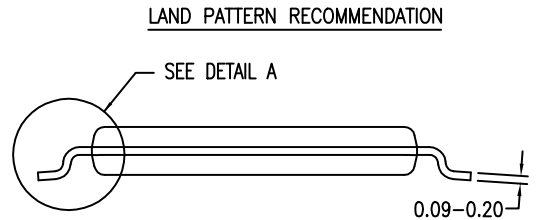
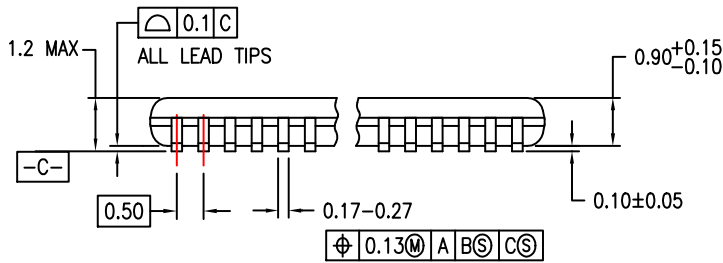
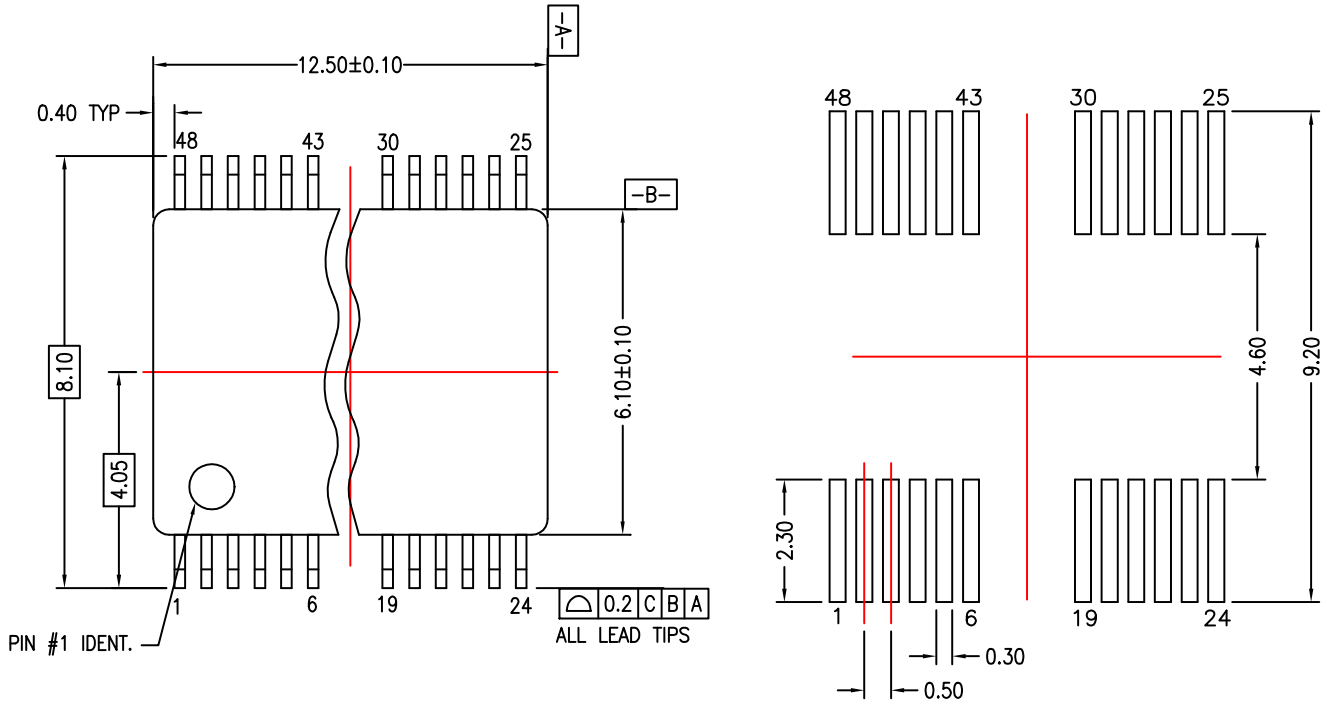

DIMENSIONS ARE IN MILLIMETERS

NOTES:

- CONFORMS TO JEDEC REGISTRATION MO-153, VARIATION ED, DATE 4/97.
- DIMENSIONS ARE IN MILLIMETERS.
- DIMENSIONS ARE EXCLUSIVE OF BURRS, MOLD FLASH, AND TIE BAR EXTRUSIONS.
- DIMENSIONS AND TOLERANCES PER ANSI Y14.5M, 1982.

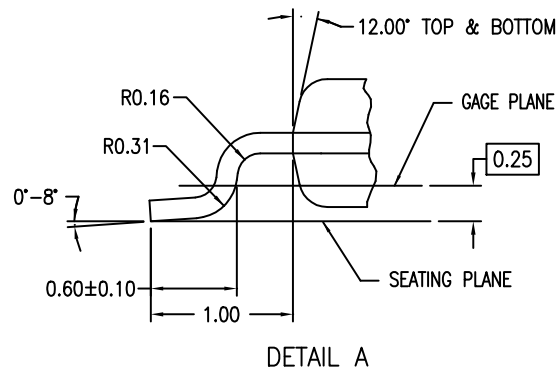

DOCUMENT NUMBER:	98AON13775G	Electronic versions are uncontrolled except when accessed directly from the Document Repository. Printed versions are uncontrolled except when stamped "CONTROLLED COPY" in red.
DESCRIPTION:	TSSOP48 12.5X6.1	PAGE 1 OF 1

ON Semiconductor and are trademarks of Semiconductor Components Industries, LLC dba ON Semiconductor or its subsidiaries in the United States and/or other countries. ON Semiconductor reserves the right to make changes without further notice to any products herein. ON Semiconductor makes no warranty, representation or guarantee regarding the suitability of its products for any particular purpose, nor does ON Semiconductor assume any liability arising out of the application or use of any product or circuit, and specifically disclaims any and all liability, including without limitation special, consequential or incidental damages. ON Semiconductor does not convey any license under its patent rights nor the rights of others.

onsemi, **Onsemi**, and other names, marks, and brands are registered and/or common law trademarks of Semiconductor Components Industries, LLC dba "**onsemi**" or its affiliates and/or subsidiaries in the United States and/or other countries. **onsemi** owns the rights to a number of patents, trademarks, copyrights, trade secrets, and other intellectual property. A listing of **onsemi**'s product/patent coverage may be accessed at www.onsemi.com/site/pdf/Patent-Marking.pdf. **onsemi** reserves the right to make changes at any time to any products or information herein, without notice. The information herein is provided "as-is" and **onsemi** makes no warranty, representation or guarantee regarding the accuracy of the information, product features, availability, functionality, or suitability of its products for any particular purpose, nor does **onsemi** assume any liability arising out of the application or use of any product or circuit, and specifically disclaims any and all liability, including without limitation special, consequential or incidental damages. Buyer is responsible for its products and applications using **onsemi** products, including compliance with all laws, regulations and safety requirements or standards, regardless of any support or applications information provided by **onsemi**. "Typical" parameters which may be provided in **onsemi** data sheets and/or specifications can and do vary in different applications and actual performance may vary over time. All operating parameters, including "Typicals" must be validated for each customer application by customer's technical experts. **onsemi** does not convey any license under any of its intellectual property rights nor the rights of others. **onsemi** products are not designed, intended, or authorized for use as a critical component in life support systems or any FDA Class 3 medical devices or medical devices with a same or similar classification in a foreign jurisdiction or any devices intended for implantation in the human body. Should Buyer purchase or use **onsemi** products for any such unintended or unauthorized application, Buyer shall indemnify and hold **onsemi** and its officers, employees, subsidiaries, affiliates, and distributors harmless against all claims, costs, damages, and expenses, and reasonable attorney fees arising out of, directly or indirectly, any claim of personal injury or death associated with such unintended or unauthorized use, even if such claim alleges that **onsemi** was negligent regarding the design or manufacture of the part. **onsemi** is an Equal Opportunity/Affirmative Action Employer. This literature is subject to all applicable copyright laws and is not for resale in any manner.

ADDITIONAL INFORMATION

TECHNICAL PUBLICATIONS:

Technical Library: www.onsemi.com/design/resources/technical-documentation
onsemi Website: www.onsemi.com

ONLINE SUPPORT: www.onsemi.com/support

For additional information, please contact your local Sales Representative at www.onsemi.com/support/sales