

User Guide for
FEBFSL206MRN_H428v1
Evaluation Board

Integrated Controller
FSL206MRN
5W Auxiliary Power Supply

Featured Fairchild Product:
FSL206MRN

***Direct questions or comments
about this evaluation board to:
“Worldwide Direct Support”***

Fairchild Semiconductor.com

Table of Contents

1. Introduction.....	3
1.1. General Description	3
1.2. Features	3
2. Specifications	4
3. Photographs.....	5
4. PCB Layout.....	6
5. Test Conditions	7
6. Performance of Evaluation Board.....	8
6.1. Startup Performance.....	8
6.2. Normal Operation	9
6.3. Voltage Stress of Secondary Diode and Drain	10
6.4. Output Ripple and Noise.....	11
6.5. Short Protections.....	12
6.6. Brown-In and Brownout Protection.....	14
6.7. Temperature Measurement	14
6.8. Output Regulation and Efficiency	15
6.9. Standby Power Consumption.....	17
6.10. EMI Measurement	19
7. Schematic	21
8. Transformer Specification	22
9. Bill of Materials	26
10. Revision History	27

This user guide supports the evaluation kit for the FSL206MR. It should be used in conjunction with the FSL206MR datasheet as well as Fairchild's application notes and technical support team. Please visit Fairchild's website at www.fairchildsemi.com.

1. Introduction

This document is an engineering report describing measured performance of the FSL206MR.

1.1. General Description

The FSL206MR integrated Pulse Width Modulator (PWM) and SenseFET is specifically designed for high-performance offline Switched-Mode Power Supplies (SMPS) with minimal external components. This device is an integrated high-voltage power regulator that combines an avalanche-rugged SenseFET with a current mode PWM control block.

The integrated PWM controller includes: 7.8V regulator for no bias winding, Under-Voltage Lockout (UVLO) protection, Leading-Edge Blanking (LEB), an optimized gate turn-on/turn-off driver, EMI attenuator, Thermal Shutdown (TSD) protection, temperature-compensated precision current sources for loop compensation, and fault-protection circuitry. Protections include Overload Protection (OLP), Over-Voltage Protection (OVP), Abnormal Over-Current Protection (AOCP), and Line Under-Voltage Protection (LUVV). During startup, the FSL206MR offers good soft-start performance.

The internal high-voltage startup switch and the Burst-Mode operation with very low operating current reduce the power loss in Standby Mode. As a result, it is possible to reach power loss of 150mW with no-bias winding and 25mW with bias winding at no-load condition when the input voltage is 265V_{AC}.

1.2. Features

- Internal Avalanche Rugged SenseFET: 650V
- Precision Fixed Operating Frequency: 67kHz
- No-Load <150mW at 265V_{AC} without Bias Winding; <25mW with Bias Winding
- No Need for Auxiliary Bias Winding
- Frequency Modulation for Attenuating EMI
- Line Under-Voltage Protection (LUVV)
- Pulse-by-Pulse Current Limiting
- Low Under-Voltage Lockout (UVLO)
- Ultra-Low Operating Current: 300μA
- Built-In Soft-Start and Startup Circuit
- Protections: Overload Protection (OLP), Over-Voltage Protection (OVP), Thermal Shutdown (TSD), Abnormal Over-Current Protection (AOCP)
- Auto-Restart Mode for All Protections

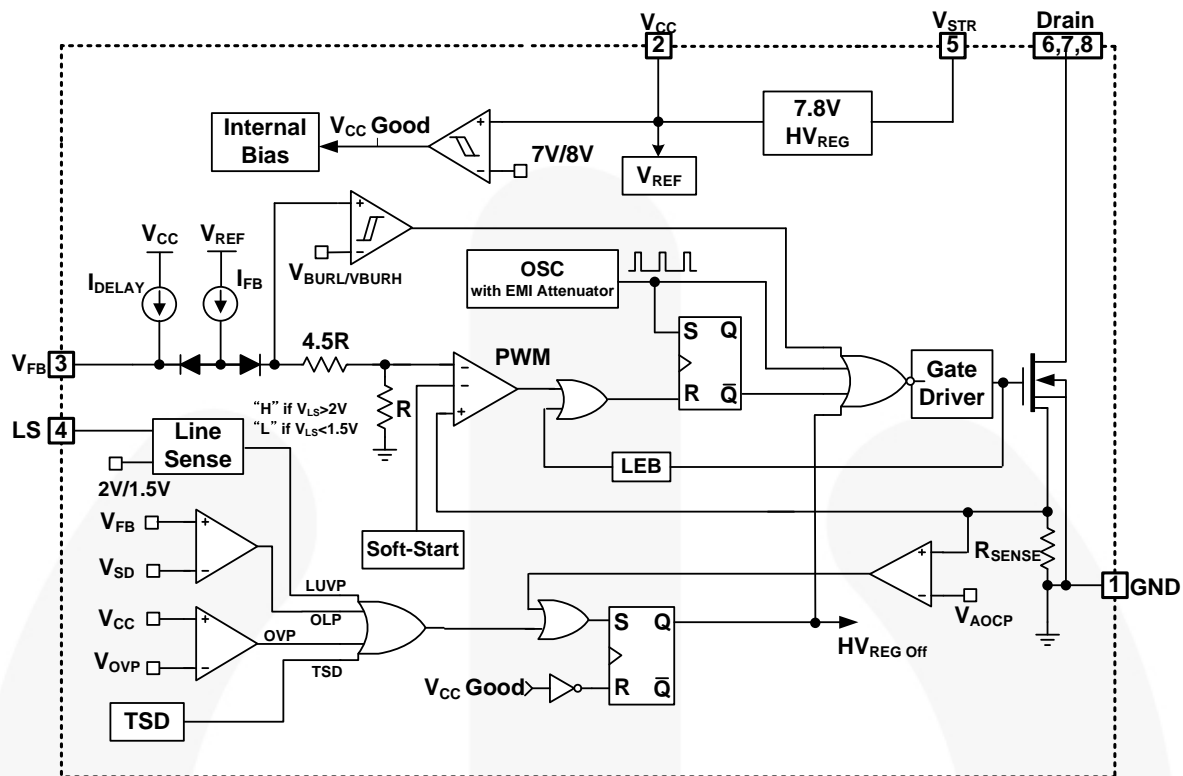

Figure 1. Internal Block Diagram

2. Specifications

Table 1. Evaluation Board Specifications

Fairchild Device	FSL206MR
Input Voltage Range	90 ~ 265 V_{AC}
Frequency	60Hz
Maximum Output Power	5W
Output Full-Load Condition	5V / 1A

3. Photographs

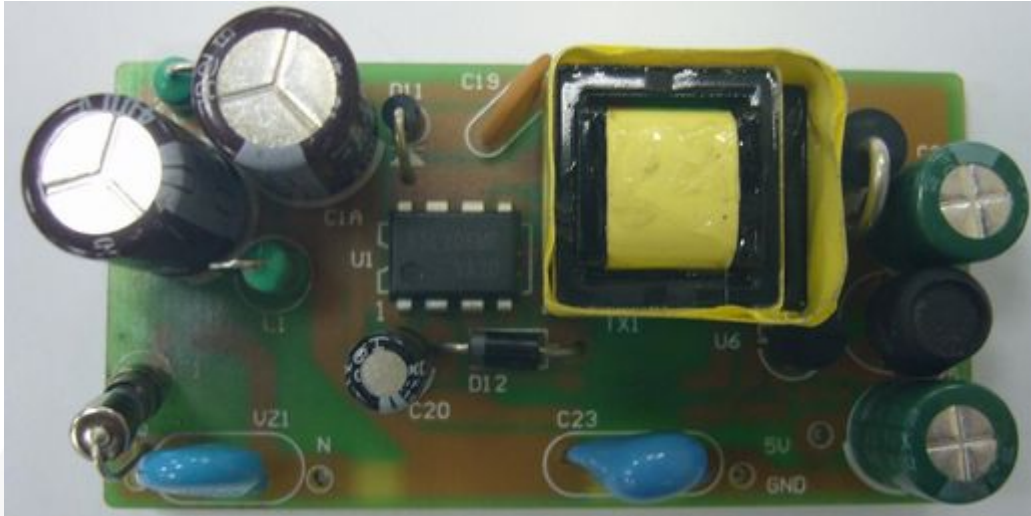

Figure 2. Top View (Dimension 64 x 33[mm²])

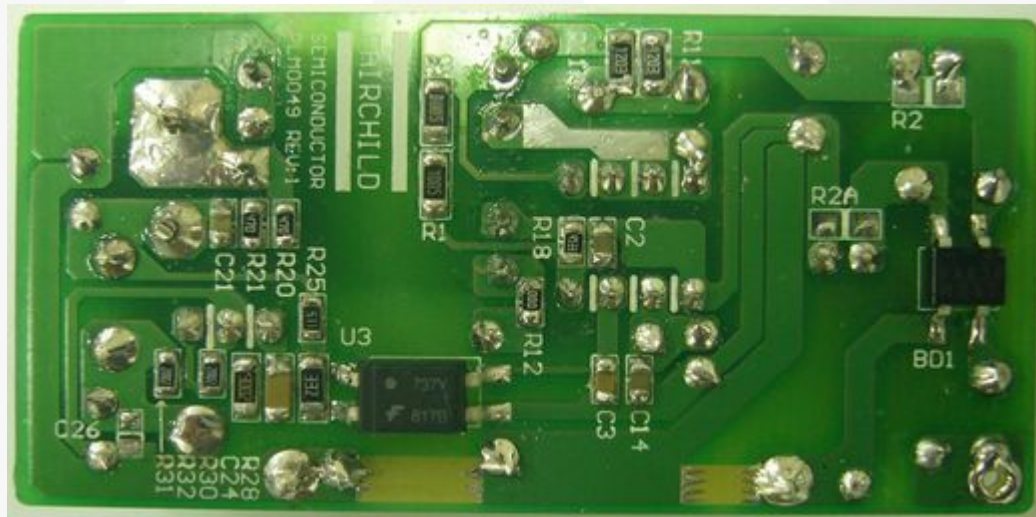

Figure 3. Bottom View (Dimension 64 x 33[mm²])

4. PCB Layout

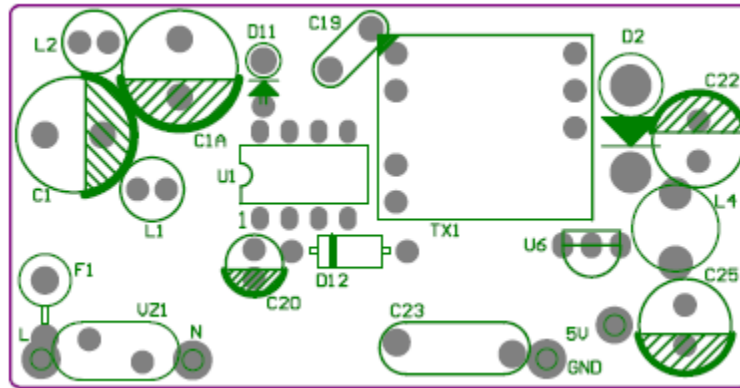

Figure 4. Top Overlay

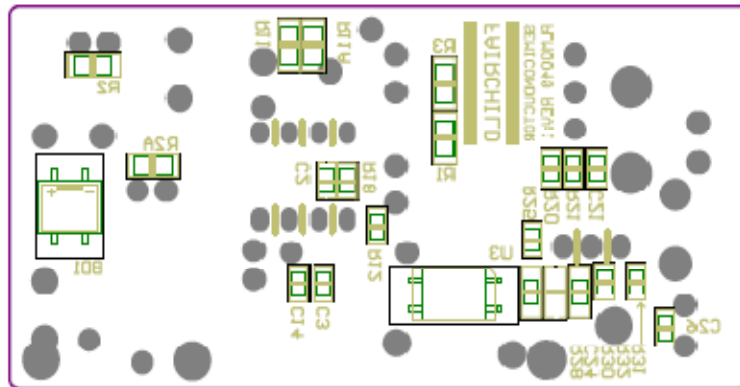

Figure 5. Bottom Overlay

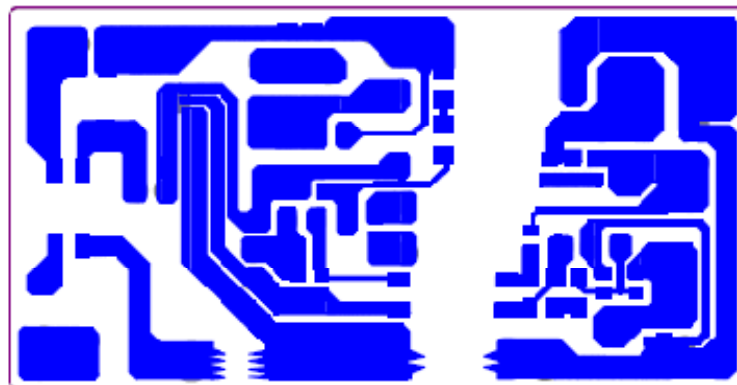

Figure 6. Bottom Layer

5. Test Conditions

Evaluation Board #	FEBFSL206MRN_H428 Evaluation Board Ver. 1.0
Test Date	August 18, 2010
Test Equipment	AC Source: 6800 Series Electronic Load: Chroma 63030 Oscilloscope: LeCroy 24Xs-A Power Meter: Yokogawa WT210
Test Items	<ol style="list-style-type: none"> 1. Startup Performance 2. Normal Operation 3. Voltage Stress of Secondary Diode and Drain 4. Output Ripple and noise 5. Short Protections 6. Brown-in and Brownout Protection 7. Temperature Measurement 8. Output Regulation and Efficiency 9. Standby Power Consumption 10. Conducted EMI Measurement

6. Performance of Evaluation Board

6.1. Startup Performance

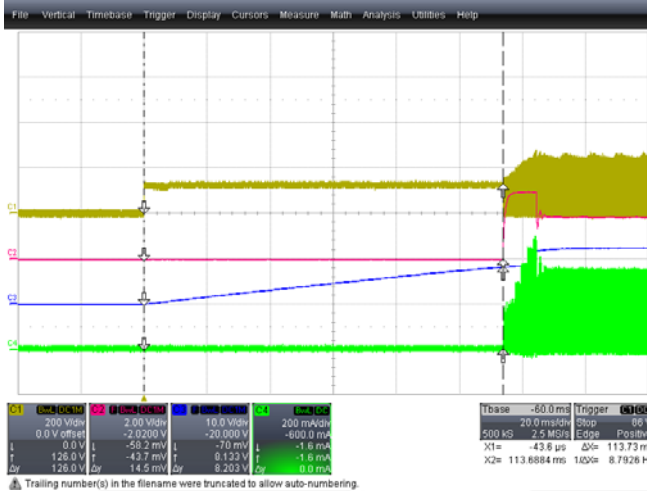

Figure 7. Startup Time (AC Input to V_{CC} UVLO HIGH) = 114ms, 90V_{AC} and Full-Load Condition (CH1: V_{DS} (200V/div), CH2: V_{FB} (2V/div), CH3: V_{CC} (10V/div), CH4: I_{DS} (200mA/div), Time: 20ms/div

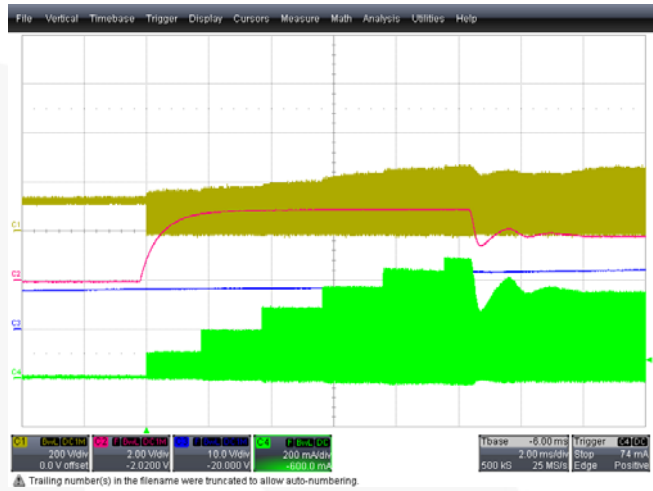

Figure 8. Soft-Start, 90V_{AC} and Full-Load Condition (CH1: V_{DS} (200V/div), CH2: V_{FB} (2V/div), CH3: V_{CC} (10V/div), CH4: I_{DS} (200mA/div), Time: 2ms/div

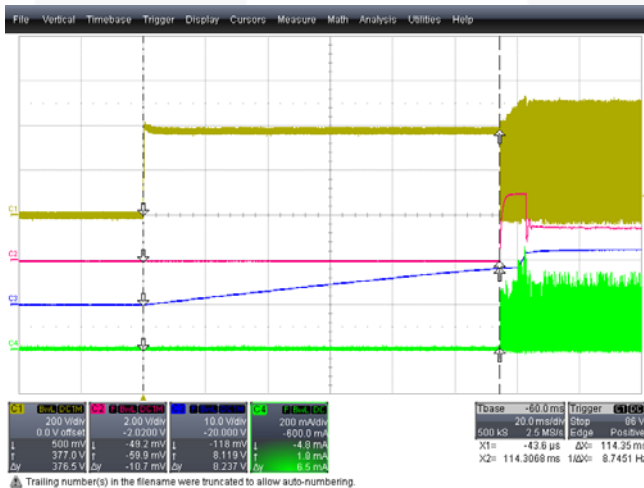

Figure 9. Startup Time (AC Input to V_{CC} UVLO HIGH) = 114ms, 265V_{AC} and Full-Load Condition, (CH1: V_{DS} (200V/div), CH2: V_{FB} (2V/div), CH3: V_{CC} (10V/div), CH4: I_{DS} (200mA/div), Time: 20ms/div



Figure 10. Soft-Start, 265V_{AC} and Full-Load Condition, (CH1: V_{DS} (200V/div), CH2: V_{FB} (2V/div), CH3: V_{CC} (10V/div), CH4: I_{DS} (200mA/div), Time: 2ms/div

6.2. Normal Operation



Figure 11. Full-Load Condition, 90V_{AC}, (CH1: V_{DS} (200V/div), CH2: V_{FB} (2V/div), CH3: V_{CC} (10V/div), CH4: I_{DS} (500mA/div), Time: 10µs/div

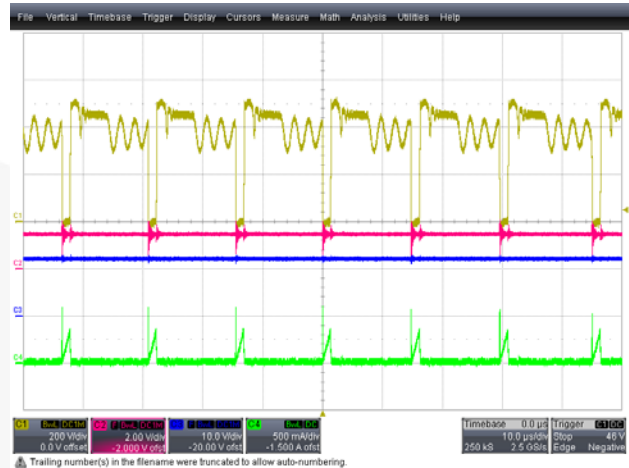

Figure 12. Full-Load Condition, 265V_{AC}, (CH1: V_{DS} (200V/div), CH2: V_{FB} (2V/div), CH3: V_{CC} (10V/div), CH4: I_{DS} (500mA/div), Time: 10µs/div



Figure 13. No-Load Condition, 90V_{AC}, (CH1: V_{DS} (200V/div), CH2: V_{FB} (2V/div), CH3: V_{CC} (10V/div), CH4: I_{DS} (200mA/div), Time: 10ms/div

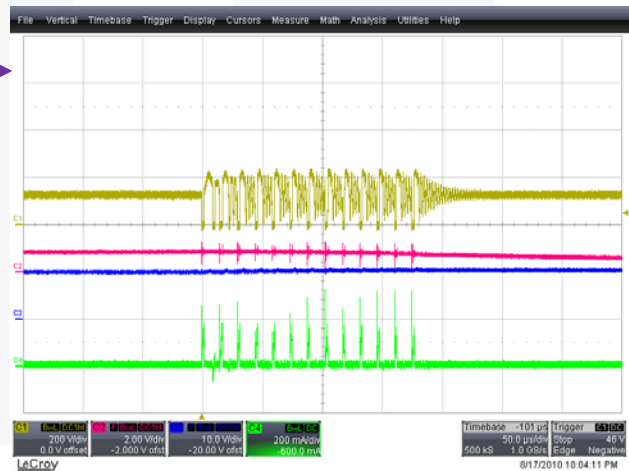

Figure 14. No-Load Condition, 90V_{AC}, (CH1: V_{DS} (200V/div), CH2: V_{FB} (2V/div), CH3: V_{CC} (10V/div), CH4: I_{DS} (200mA/div), Time: 50µs/div

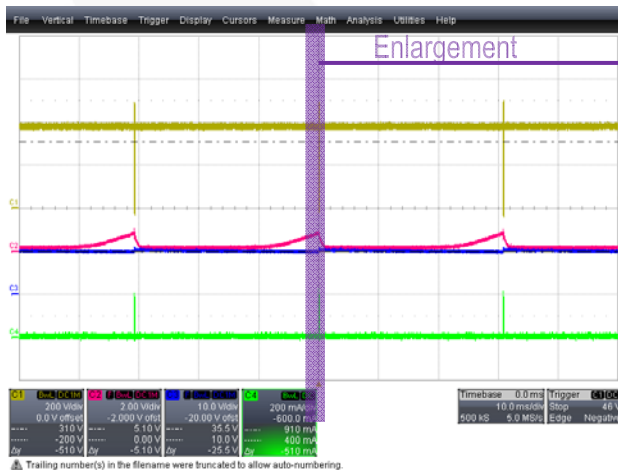

Figure 15. No-Load Condition, 265V_{AC}, (CH1: V_{DS} (200V/div), CH2: V_{FB} (2V/div), CH3: V_{CC} (10V/div), CH4: I_{DS} (200mA/div), Time: 10ms/div

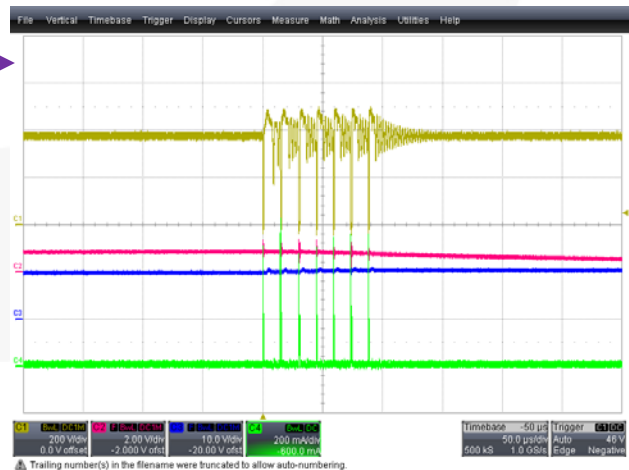

Figure 16. No-Load Condition, 265V_{AC}, (CH1: V_{DS} (200V/div), CH2: V_{FB} (2V/div), CH3: V_{CC} (10V/div), CH4: I_{DS} (200mA/div), Time: 50µs/div

6.3. Voltage Stress of Secondary Diode and Drain

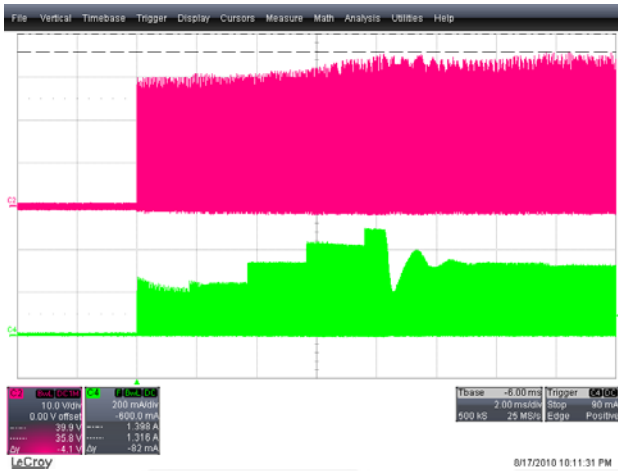

Figure 17. $V_{DIODE,MAX}$ at Startup=35.8V, 5V Output Diode with 265V_{AC} & Full-Load Condition, CH2: V_{DIODE} (10V/div), CH4: I_{DS} (200mA/div), Time: 2ms/div



Figure 18. $V_{DIODE,MAX}$ at Normal = 35.7V, 5V Output Diode with 265V_{AC} & Full-Load Condition, CH2: V_{DIODE} (10V/div), CH4: I_{DS} (200mA/div), Time: 5µs/div

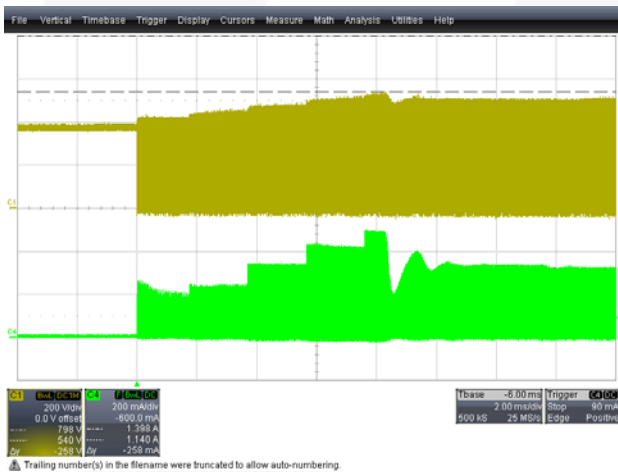

Figure 19. $V_{DS,MAX}$ at Startup = 540V, Drain Voltage with 265V_{AC} & Full-Load Condition, CH2: V_{DS} (200V/div), CH4 : I_{DS} (200mA/div), Time: 2ms/div

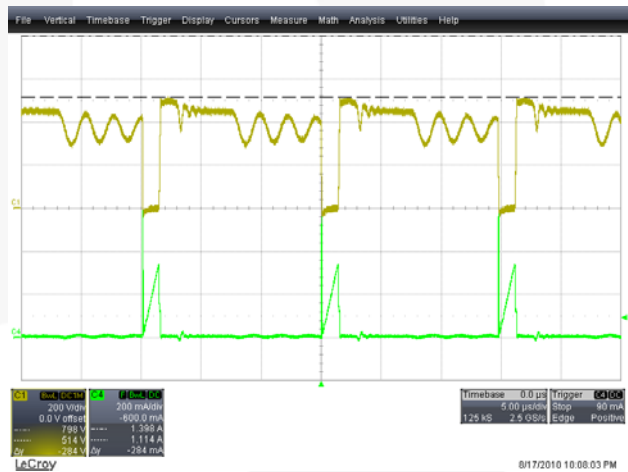

Figure 20. $V_{DS,MAX}$ at Normal = 514V, Drain Voltage with 265V_{AC} & Full-Load Condition, CH2: V_{DS} (200V/div), CH4 : I_{DS} (200mA/div), Time: 2ms/div & 5µs/div

6.4. Output Ripple and Noise

Maximum output ripple is measured at maximum output power in Burst Mode.

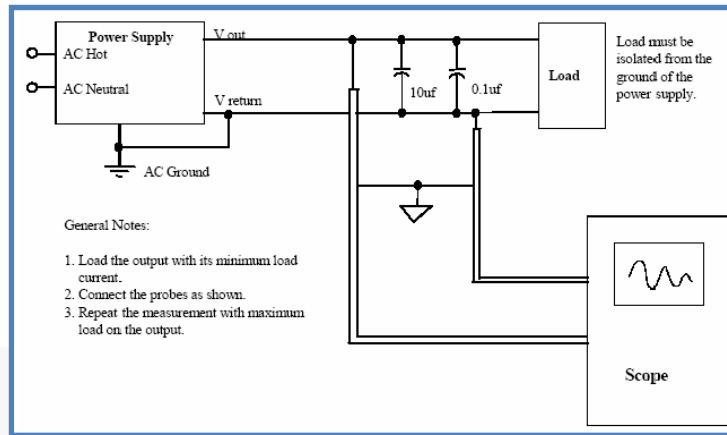

Figure 21. Recommended Test Setup

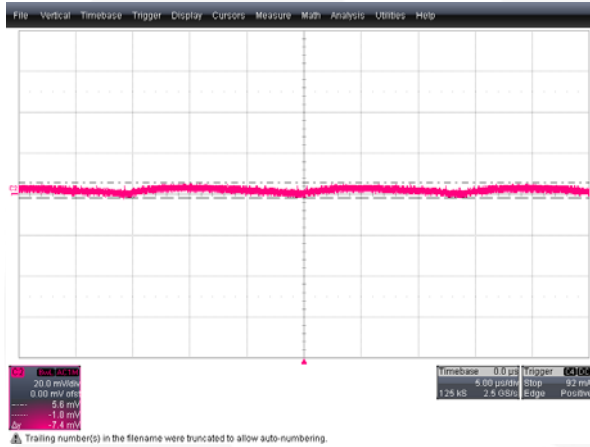

Figure 22. $V_{O_RIPPLE} = 7.4\text{mV}$, Output with 90V_{AC} and Full-Load Condition, CH2: V_O (20mV/div), Time: 5µs/div

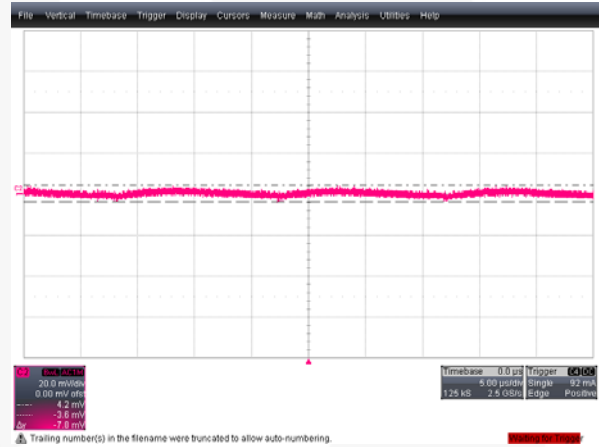

Figure 23. $V_{O_RIPPLE} = 7.8\text{mV}$, Output with 265V_{AC} and Full-Load Condition, CH2: V_O (20mV/div), Time: 5µs/div

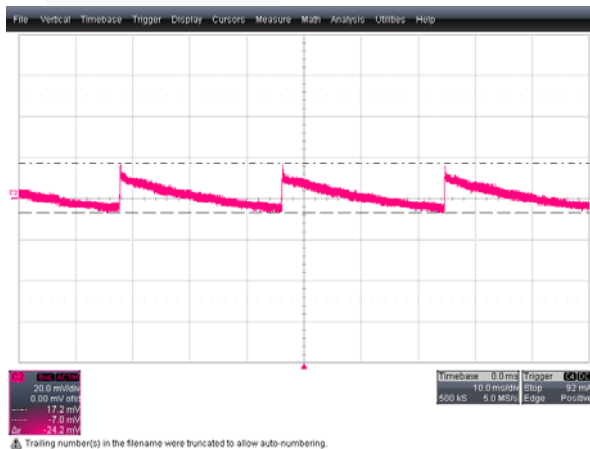

Figure 24. $V_{O_RIPPLE} = 24.2\text{mV}$, Output with 90V_{AC} and No-Load Condition, CH2: V_O (20mV/div), Time: 10ms/div

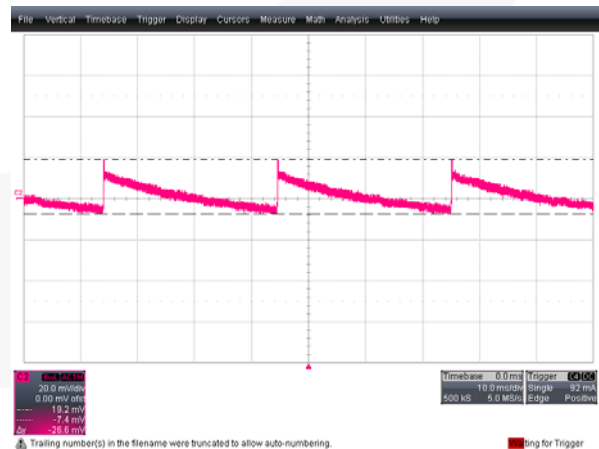

Figure 25. $V_{O_RIPPLE} = 26.6\text{mV}$, Output with 265V_{AC} and No-Load Condition, CH2: V_O (20mV/div), Time: 10ms/div

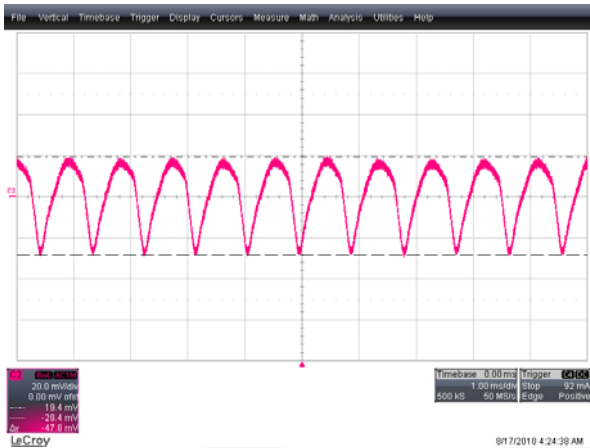

Figure 26. $V_{O_RIPPLE} = 47.8\text{mV}$, Maximum Output Ripple at 90V_{AC} , CH2: V_O (20mV/div), Time: 1ms/div

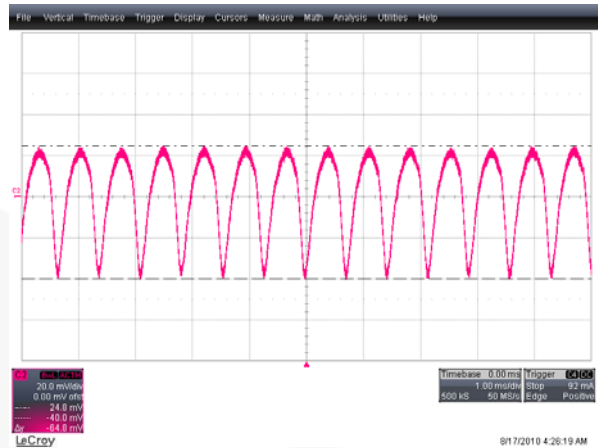

Figure 27. $V_{O_RIPPLE} = 64.8\text{mV}$, Maximum Output Ripple at 265V_{AC} , CH2: V_O (20mV/div), Time: 1ms/div

6.5. Short Protections

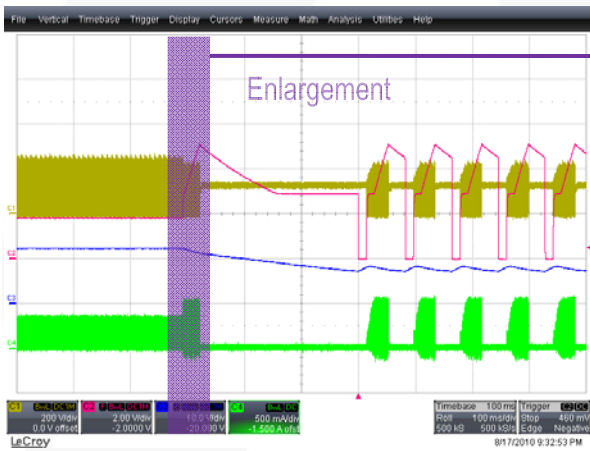

Figure 28. OLP Triggered: $V_{FB} = 5.10\text{V}$, Output Short with 90V_{AC} and Full-Load, CH1: V_{DS} (200V/div), CH2: V_{FB} (2V/div), CH3: V_{CC} (10V/div), CH4: I_{DS} (500mA/div), Time: 100ms/div and 10ms/div

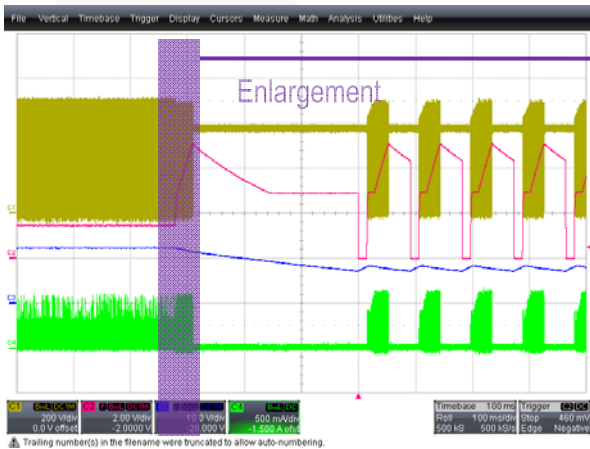
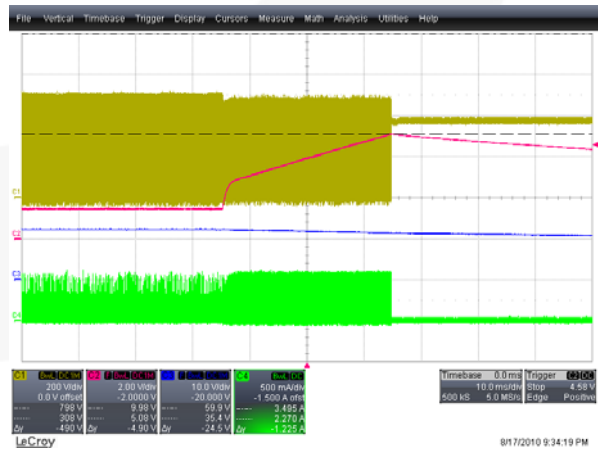

Figure 29. OLP Triggered: $V_{FB} = 5.08\text{V}$, Output Short with 265V_{AC} and Full-Load, CH1: V_{DS} (200V/div), CH2: V_{FB} (2V/div), CH3: V_{CC} (10V/div), CH4: I_{DS} (500mA/div), Time: 100ms/div and 10ms/div



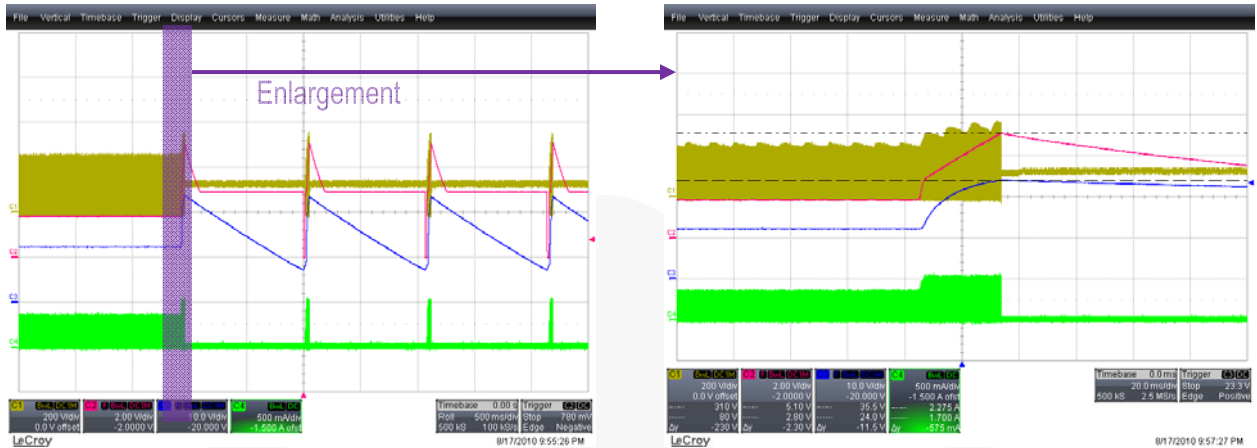

Figure 30. OLP Triggered: $V_{FB} = 5.10V$, Opto-Coupler Second Short (Open-Loop Test), with 90V_{AC} and Full-Load, CH1: V_{DS} (200V/div), CH2: V_{FB} (2V/div), CH3: V_{CC} (10V/div), CH4: I_{DS} (500mA/div), Time: 500ms/div and 20ms/div

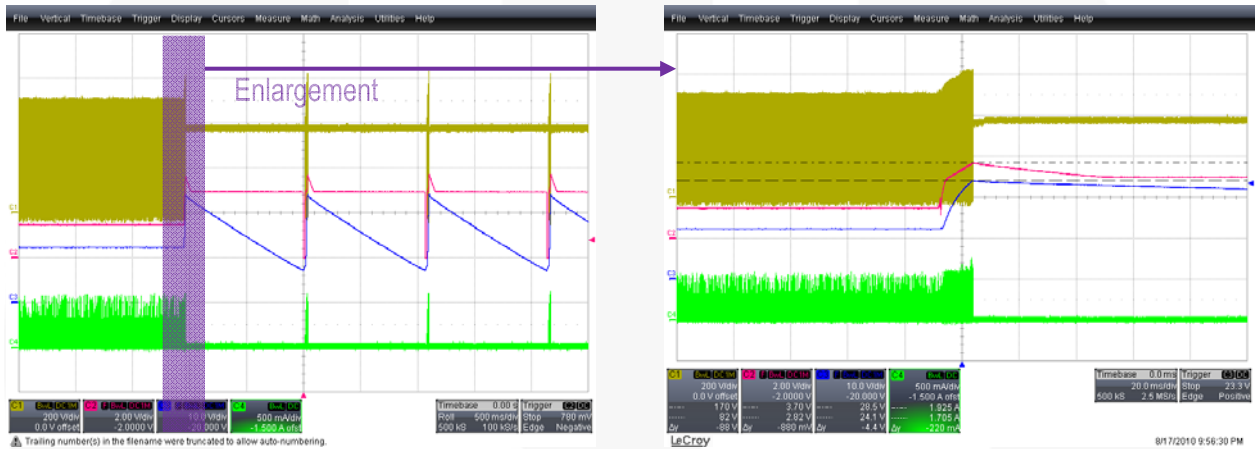

Figure 31. OVP Triggered: $V_{CC} = 24.1V$, Opto-Coupler Second Short (Open-Loop Test), with 265V_{AC} and Full-Load, CH1: V_{DS} (200V/div), CH2: V_{FB} (2V/div), CH3: V_{CC} (10V/div), CH4: I_{DS} (500mA/div), Time: 500ms/div and 20ms/div

6.6. Brown-In and Brownout Protection

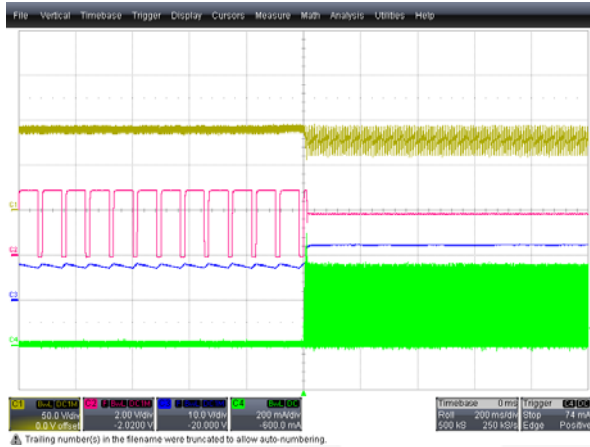

Figure 1. Brown-In 65V_{AC} and Full-Load Condition, CH1: V_{IN} (50V/div), CH2: V_{FB} (2V/div), CH3: V_{CC} (10V/div), CH4: I_{DS} (200mA/div), Time: 200ms/div

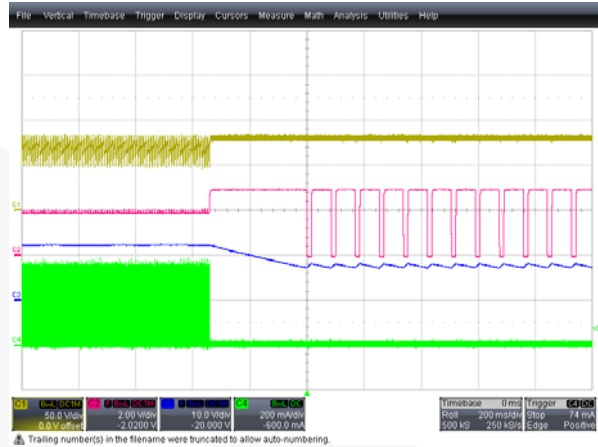

Figure 2. Brown-out 58V_{AC} and Full-Load Condition, CH1: V_{IN} (50V/div), CH2: V_{FB} (2V/div), CH3: V_{CC} (10V/div), CH4: I_{DS} (200mA/div), Time: 200ms/div

6.7. Temperature Measurement

Table 2. Temperature Test Result

Input Voltage		90V _{AC}	110V _{AC}	230V _{AC}	265V _{AC}
Temperature	IC	44.0°C	43.3°C	44.6°C	46.2°C
	DIODE	56.8°C	56.8°C	57.7°C	58.2°C
	Transformer	49.7°C	49.8°C	51.6°C	52.6°C
Room Temperature		24.4°C	24.4°C	24.4°C	24.4°C

6.8. Output Regulation and Efficiency

- Test condition: with bias winding
- Test method:
 - Test after 15 minutes aging
 - Test in order: from high line input to low line input
 - Test in order: from heavy load to light load

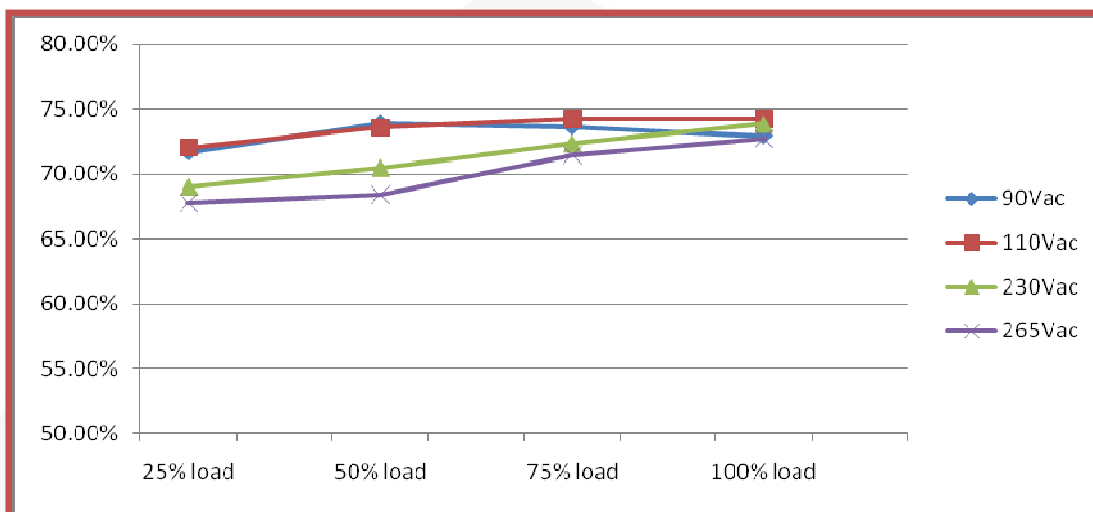

Figure 3. Efficiency vs Output Load and Input Voltage

Table 3. Efficiency Test Result

	90V _{AC}		110V _{AC}		230V _{AC}		265V _{AC}	
	Input Voltage	Output Current	Input Voltage	Output Current	Input Voltage	Output Current	Input Voltage	Output Current
5.00W	5.023V	1.000A	5.023V	1.000A	5.022V	1.000A	5.022V	1.000A
	6.887W		6.765W		6.801W		6.908W	
	72.93%		74.25%		73.84%		72.70%	
3.75W	5.026V	0.750A	5.025V	0.750A	5.024V	0.750A	5.024V	0.750A
	5.119W		5.075W		5.209W		5.273W	
	73.64%		74.26%		72.34%		71.46%	
2.50W	5.027V	0.500A	5.027V	0.500A	5.026V	0.500A	5.026V	0.500A
	3.402W		3.416W		3.566W		3.676W	
	73.88%		73.58%		70.47%		68.36%	
1.25W	5.028V	0.250A	5.028V	0.250A	5.028V	0.250A	5.028V	0.250A
	1.754W		1.745W		1.822W		1.855W	
	71.66%		72.03%		68.99%T		67.76%	
Average	73.03%		73.53%		71.41%		70.07%	

- Test condition: Without bias winding (removing R12)
- Test method:
 - Test after 15 minutes aging
 - Test in order: from high line input to low line input
 - Test in order: from heavy load to light load

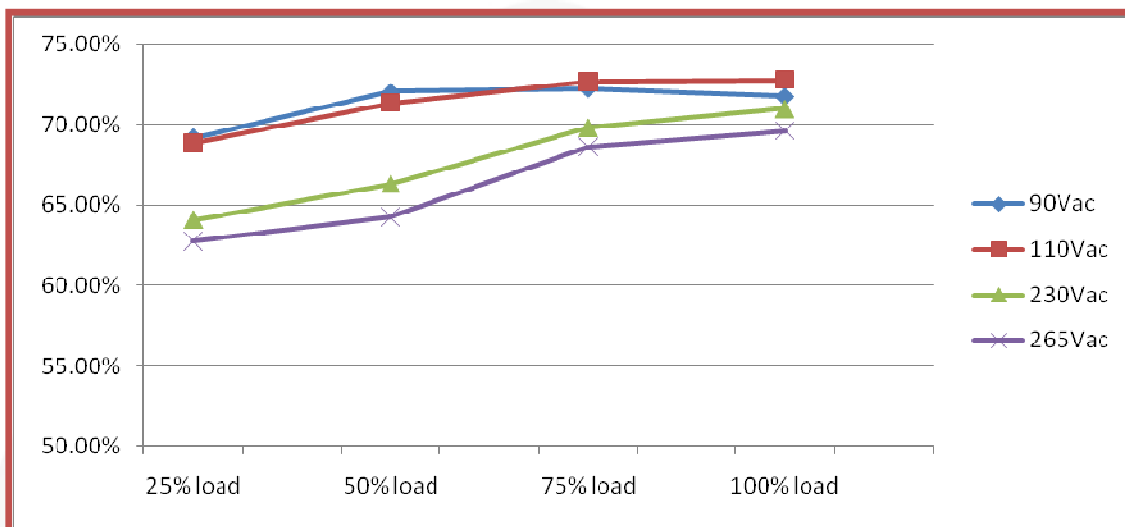

Figure 4. Efficiency vs Output Load and Input Voltage

Table 4. Efficiency Test Result

	90V _{AC}		110V _{AC}		230V _{AC}		265V _{AC}	
5.00W	5.023V	1.000A	5.023V	1.000A	5.023V	1.000A	5.023V	1.000A
	7.001W		6.901W		7.074W		7.213W	
	71.75%		72.79%		71.01%		69.64%	
3.75W	5.025V	0.750A	5.025V	0.750A	5.024V	0.750A	5.024V	0.750A
	5.216W		5.186W		5.396W		5.489W	
	72.25%		72.67%		69.83%		68.65%	
2.50W	5.026V	0.500A	5.026V	0.500A	5.025V	0.500A	5.025V	0.500A
	3.488W		3.522W		3.788W		3.909W	
	72.05%		71.35%		66.33%		64.27%	
1.25W	5.028V	0.250A	5.028V	0.250A	5.028V	0.250A	5.028V	0.250A
	1.817W		1.826W		1.962W		2.002W	
	69.18%		68.84%		64.07%		62.79%	
Average	71.31%		71.41%		67.81%		66.34%	

6.9. Standby Power Consumption

Table 5. With Bias Winding Condition

	90V_{AC}	110V_{AC}	230V_{AC}	265V_{AC}
No Load	12mW	13mW	19mW	24mW
10mA	94mW	94mW	102mW	107mW
20mA	172mW	169mW	182mW	191mW
50mA	386mW	384mW	409mW	420mW
70mA	520mW	523mW	552mW	569mW
100mA	729mW	729mW	772mW	786mW

Table 6. Without Bias Winding Condition

	90V_{AC}	110V_{AC}	230V_{AC}	265V_{AC}
No Load	46mW	56mW	114mW	134mW
10mA	128mW	135mW	202mW	224mW
20mA	207mW	215mW	283mW	306mW
50mA	428mW	436mW	513mW	540mW
70mA	566mW	576mW	664mW	687mW
100mA	775mW	787mW	881mW	908mW

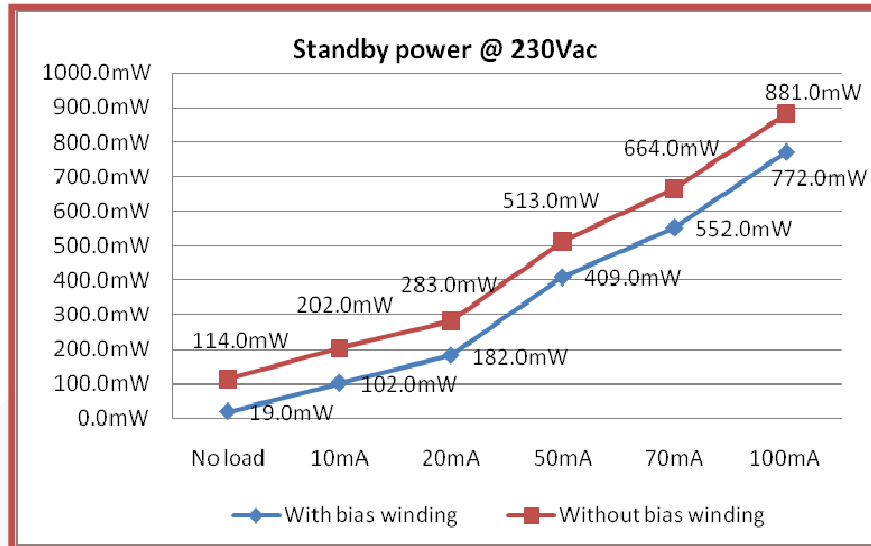

Figure 5. Standby Power at 230V_{AC}

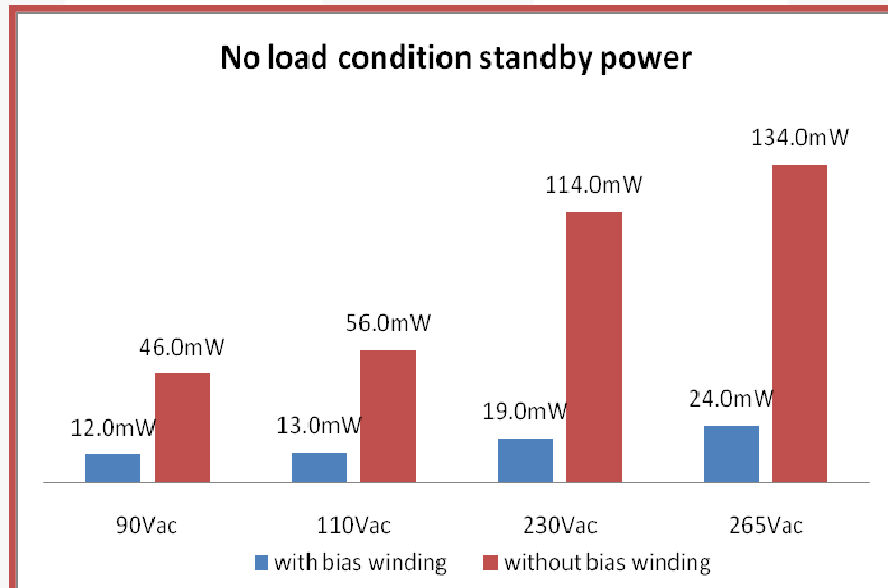

Figure 6. No-Load Condition Standby Power

6.10. EMI Measurement

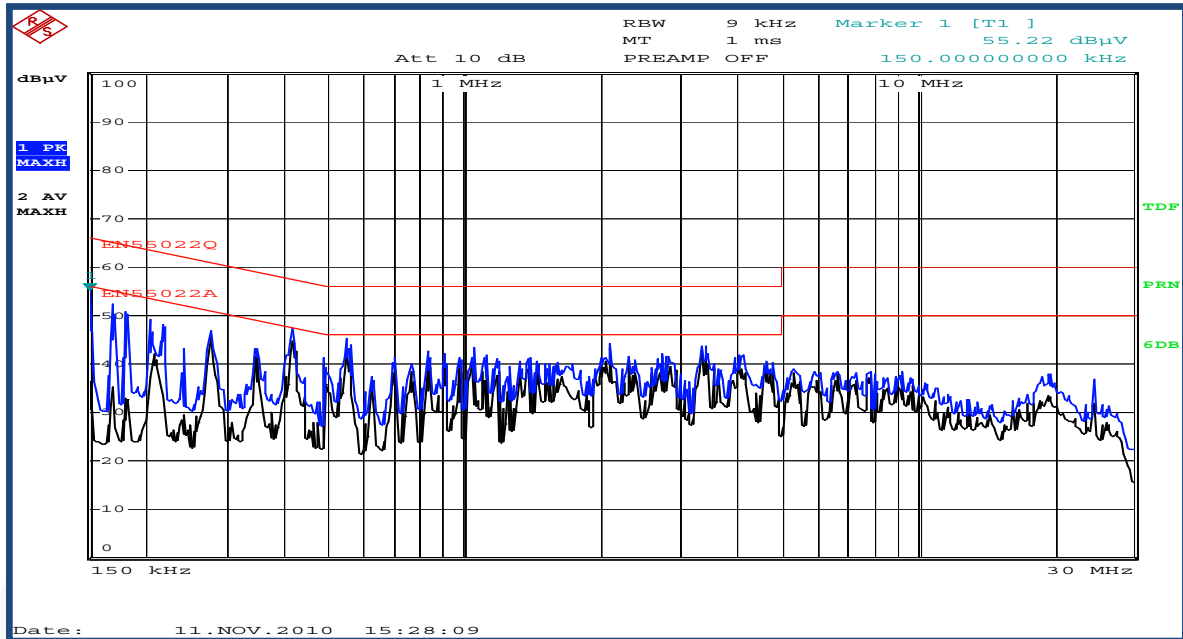

Figure 7. L1 at 230V_{AC}

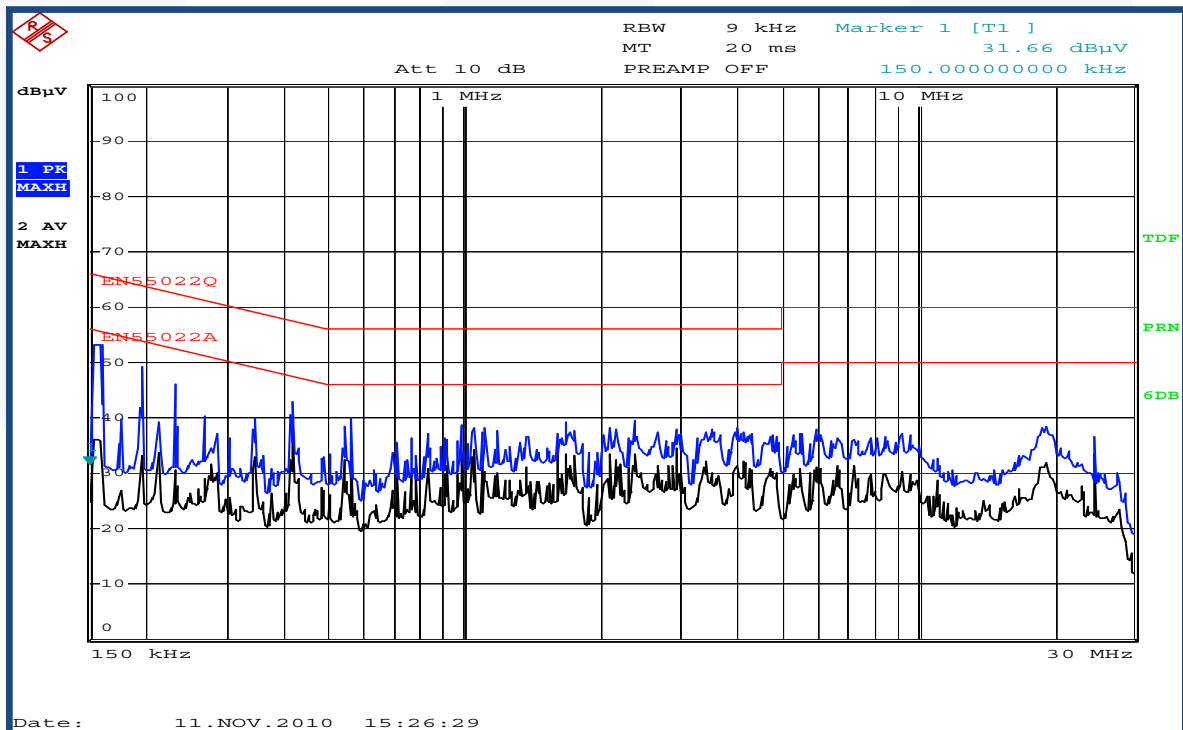

Figure 8. N at 230V_{AC}

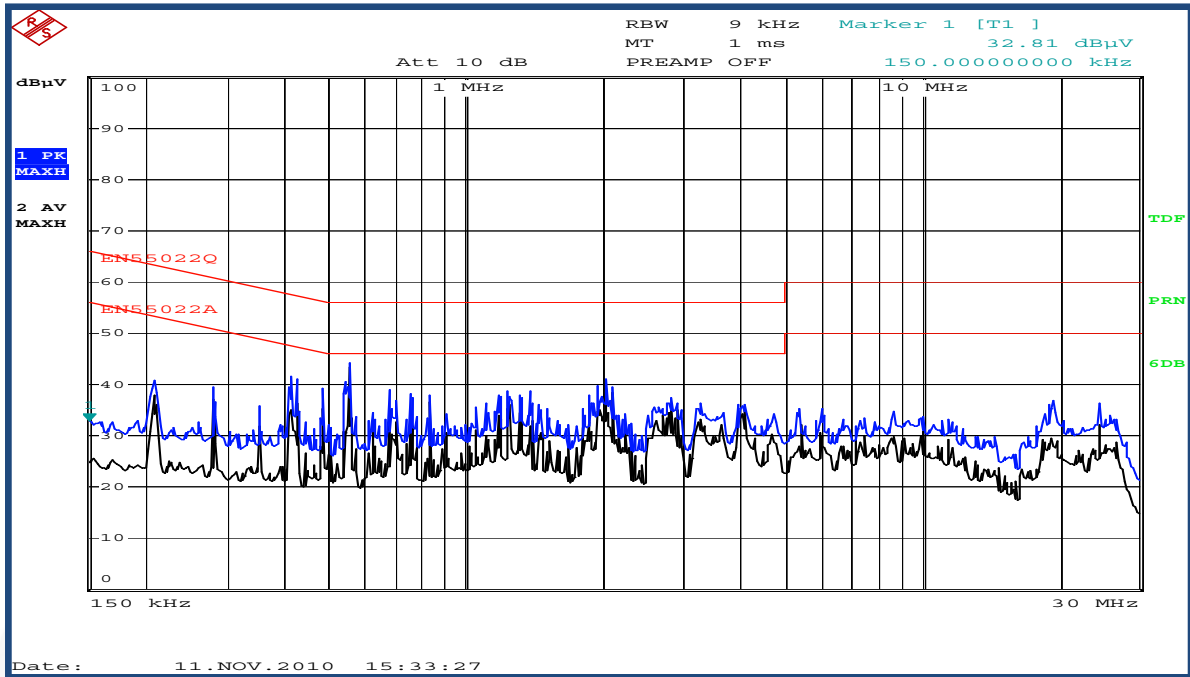

Figure 9. L1 at 110V_{AC}

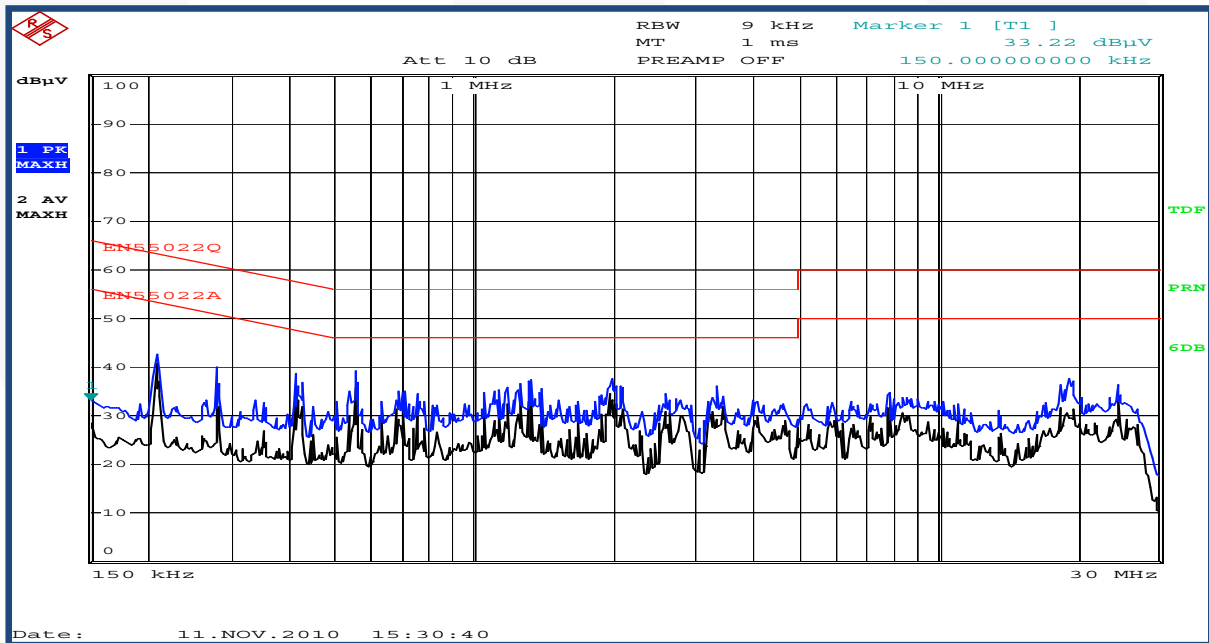

Figure 10. N at 110V_{AC}

7. Schematic

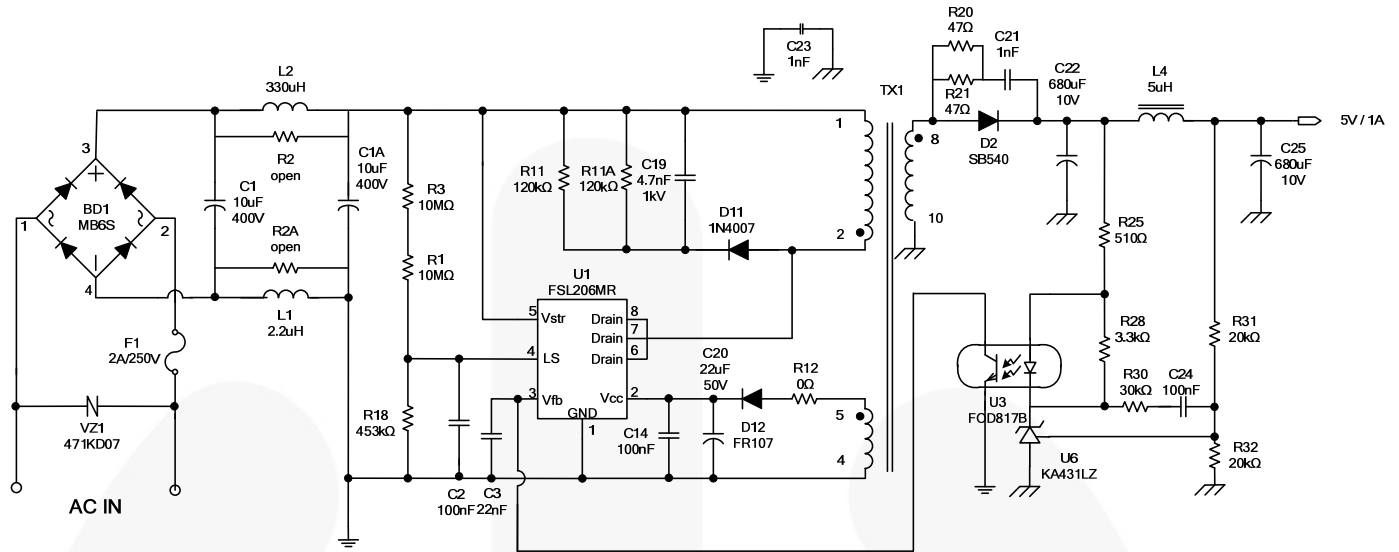

Figure 11. Schematic

8. Transformer Specification

Customer	-			P/N:	TRN-0299
DATE	08/12/2010	Version	A	Page	1/4
1.DIMENSION					
<p>A: 17.5mm MAX B: 19.5mm MAX C: 21.0mm MAX D: 4.0± 0.5mm E: 3.2± 0.5mm F: 15.5± 0.5mm G: 0.8± 0.1mm</p>					
<ol style="list-style-type: none"> Pin3.6.7.removed wire shield: 2UEW 0.15*1, pin 1 Add 14mm insulation tape *4 turns to fix core and bobbin. 					
UNIT	m/m	DRAWN	CHECK	TITLE	TRANS
TEL	(02)29450588	Ci wun Chen	Guo long Huang	IDENT N.O.	TRN-0299
FAX	(02)29447647	SEN HUEI INDUSTRIAL CO.,LTD.		D W G N.O.	
No.26-1, Lane 128, Sec. 2, Singnan Rd., Jhonghe City, Taipei County 235, Taiwan (R.O.C.)					
Customer	-			P/N:	TRN-0299

DATE	08/12/2010	Version	A	Page	2/4
------	------------	---------	---	------	-----

2. Schematic:

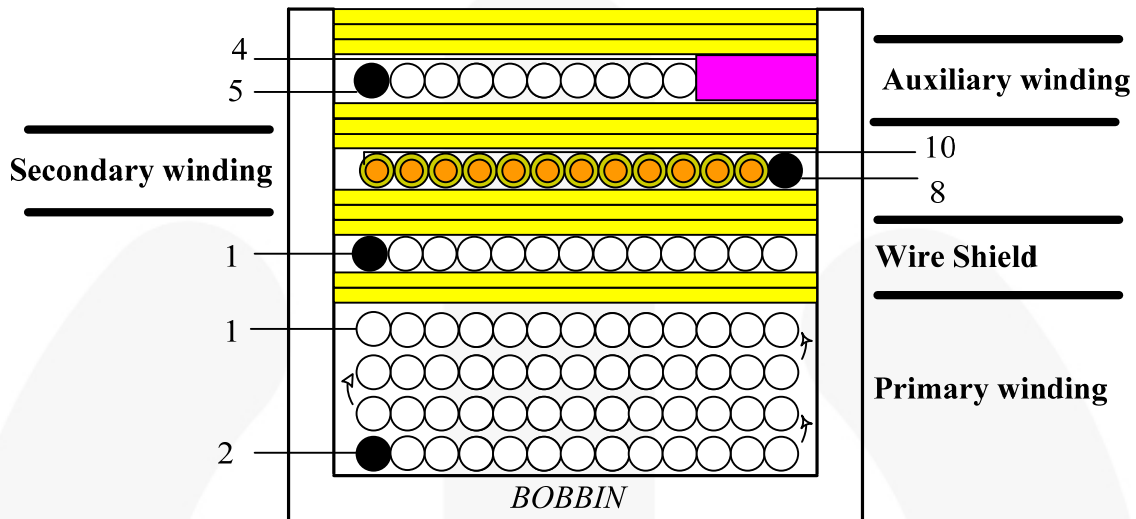

1. When W3 is winding, it must winds one layers.
2. W4 layer wire size can be smaller if there is no area for 20 turns.
3. if there is extra area when W4 is winding, please fill the area with barrier tape.

NO	TERMINAL		WIRE	T _s	INSULATION		BARRIER	
	S	F			T _s	Pri	S	
W1	2	1	2UEW 0.2*1	140	2			
W2	1	-	2UEW 0.15*1	45	3			
W3	8	10	TEX-E 0.55*1	9	3			
W4	5	4	2UEW 0.25*1	20	3			2mm
			CORE ROUNDING TAPE		3			

UNIT	m/m	DRAWN	CHECK	TITLE	TRANS
TEL	(02)29450588	Ci wun Chen	Guo long Huang	IDENT N O.	TRN-0299
FAX	(02)29447647	SEN HUEI INDUSTRIAL CO.,LTD.		D W G N O.	
No.26-1, Lane 128, Sec. 2, Singnan Rd., Jhonghe City, Taipei County 235, Taiwan (R.O.C.)					
Customer	-			P/N:	TRN-0299
DATE	08/12/2010	Version	A	Page	3/4

3. Electrical Specification

3.1 inductance test: **at 67KHz ,1V**

P(2-1): **1.4mH ±7%**

3.2 Hi-pot test:

AC 3.0KV / 60Hz / 5mA hi-pot for one minute between pri to sec.
AC 1.5KV / 60Hz / 5mA hi-pot for one minute between pri to core.
AC 1.5KV / 60Hz / 5mA hi-pot for one minute between sec to core.

3.3 insulation test:

The insulation resistance is between pri to sec and windings to core measured by DC 500V, must be over 100MΩ.

3.4 Terminal strength:

1.0Kg on terminals for 30 seconds, test the breakdown.

UNIT	m/m	DRAWN	CHECK	TITLE	TRANS
TEL	(02)29450588	Ci wun Chen	Guo long Huang	IDENT N O.	TRN-0299
FAX	(02)29447647	SEN HUEI INDUSTRIAL CO.,LTD.		D W G N O.	
No.26-1, Lane 128, Sec. 2, Singnan Rd., Jhonghe City, Taipei County 235, Taiwan (R.O.C.)					

Customer				P/N:	TRN-0299
DATE	08/12/2010	Version	A	Page	4/4

4. Materials List

COMPONENT	MAT'L	MANUFACTURE	FILE NO.
1.Bobbin	Phenolic 94V-0,T373J,150°C	EE-16.(TF-1613) Chang Chun plastics co. ltd.	E59481(S)
2.Core	PC-40,BH2,2E6 3C85,NC-2H,	Ferrite core EE-16 TDK,Tokin.Tomita.Philip.Nicera.	
3.Wire	UEWE 130°C °C	Tai-I electric wire & cable Co Ltd.	E85640 (S)
	UEW-2 130°C	Jung Shing wire Co Ltd.	E174837
	UEW-B 130°C	Chuen Yih wire Co Ltd.	E154709(S)
	TEX-E 105°C / 120°C	Furukawa electric Co Ltd.	E206440
4.Varnish	BC-346A 180°C	John C Dolph Co Ltd.	E51047 (M)
	468-2FC 130°C	Ripley resin engineering co inc.	E81777 (N)
5.Tape t=0.064mm	31CT 130°C	Nitto denk CORP.	E34833 (M)
	Polyester 3M #1350(b) 130°C	Minnesota mining & MFG Co Ltd. CTI material group II	E17385 (N)
6.Tube	Teflon tube TFL 150V,200°C	Great holding industrial Co Ltd.	E156256 (S)
7.Terminals	Tin coated- Copper wire	Will for special wire CORP.	
8.Shield	Copper foil	Hitachi cable lid. (copper foil: 0.025t x7mm)	

UNIT	m/m	DRAWN	CHECK	TITLE	TRANS
TEL	(02)29450588	Ci wun Chen	Guo long Huang	IDENT N O.	TRN-0299
FAX	(02)29447647	SEN HUEI INDUSTRIAL CO.,LTD.		D W G N O.	11613
No.26-1, Lane 128, Sec. 2, Singnan Rd., Jhonghe City, Taipei County 235, Taiwan (R.O.C.)					

9. Bill of Materials

Component	Qty.	Part No.	Manufacturer	Reference
Chip Resistor 0805 0Ω ±5%	1			R12
Chip Resistor 0805 47Ω ±5%	2			R20, R21
Chip Resistor 0805 510Ω ±5%	1			R25
Chip Resistor 0805 20KΩ ±1%	2			R31, R32
Chip Resistor 0805 453KΩ ±1%	1			R18
Chip Resistor 1206 3K3Ω ±5%	1			R28
Chip Resistor 1206 30KΩ ±1%	1			R30
Chip Resistor 1206 120KΩ ±1%	2			R11, R11A
Chip Resistor 1206 10MΩ ±1%	2			R1, R3
Ceramic Capacitor 472P 1KV +80/-20%	1			C19
0805 MLCC X7R ±10% 102P 100V	1			C21
0805 MLCC X7R ±10% 104P 50V	2			C2, C14
0805 MLCC X7R ±10% 223P 50V	1			C3
1206 MLCC X7R ±10% 104P 50V	1			C24
Electrolytic Capacitor 10μH 400V 105°C	2	KM	SAMXON	C1, C1A
Electrolytic Capacitor 22μH 50V 105°C	1	LHK	JACKCON	C20
Electrolytic Capacitor 680μH 10V 105°C	2	GF	SAMXON	C22, C25
Y1 Capacitor 102P 250V ±20%	1			C23
Inductor DR6X8 5μH	1	TRN0216	SEN HUEI	L4
Fixed Inductor 2.2μH ±10%	1	EC36-2R2K	SYNTON	L1
Fixed Inductor 330μH ±10%	1	EC36-331K	SYNTON	L2
Transformer EE-16-H 1.4mH	1	TRN0299	SEN HUEI	TX1
Diode 1A/1000V DO-41	1	1N4007	TAPING	D11
Fast Diode 1A/1000V DO-41	1	FR107	CP	D12
Diode DO-210AD 5A/40V	1	SB540		D2
SMD Bridge 0.5A/600V SOIC-4	1	MB6S	Fairchild Semiconductor	BD1
REGULATOR KA431L ±0.5%	1		Fairchild Semiconductor	U6
IC FOD817B SMDIP-B	1		Fairchild Semiconductor	U3
IC SMPS Power Switch	1	FSL206MRN	Fairchild Semiconductor	U1
FUSE GLASS 250V2A Fast Blow	1	3.6*10mm	SLEEK	F1
Varistor 7μ470V	1			VZ1
PCB PLM0049 REV1	1			

10. Revision History

Rev.	Date	Description
1.0.0		Change User Guide EVB number from FEB428_001 to FEBFSL206MRN_H428v1
1.0.1	3/6/12	Formatting & Editing pass by Tech Docs prior to posting

WARNING AND DISCLAIMER

Replace components on the Evaluation Board only with those parts shown on the parts list (or Bill of Materials) in the Users' Guide. Contact an authorized Fairchild representative with any questions.

This board is intended to be used by certified professionals, in a lab environment, following proper safety procedures. Use at your own risk. The Evaluation board (or kit) is for demonstration purposes only and neither the Board nor this User's Guide constitute a sales contract or create any kind of warranty, whether express or implied, as to the applications or products involved. Fairchild warrants that its products meet Fairchild's published specifications, but does not guarantee that its products work in any specific application. Fairchild reserves the right to make changes without notice to any products described herein to improve reliability, function, or design. Either the applicable sales contract signed by Fairchild and Buyer or, if no contract exists, Fairchild's standard Terms and Conditions on the back of Fairchild invoices, govern the terms of sale of the products described herein.

DISCLAIMER

FAIRCHILD SEMICONDUCTOR RESERVES THE RIGHT TO MAKE CHANGES WITHOUT FURTHER NOTICE TO ANY PRODUCTS HEREIN TO IMPROVE RELIABILITY, FUNCTION, OR DESIGN. FAIRCHILD DOES NOT ASSUME ANY LIABILITY ARISING OUT OF THE APPLICATION OR USE OF ANY PRODUCT OR CIRCUIT DESCRIBED HEREIN; NEITHER DOES IT CONVEY ANY LICENSE UNDER ITS PATENT RIGHTS, NOR THE RIGHTS OF OTHERS.

LIFE SUPPORT POLICY

FAIRCHILD'S PRODUCTS ARE NOT AUTHORIZED FOR USE AS CRITICAL COMPONENTS IN LIFE SUPPORT DEVICES OR SYSTEMS WITHOUT THE EXPRESS WRITTEN APPROVAL OF THE PRESIDENT OF FAIRCHILD SEMICONDUCTOR CORPORATION.

As	used	herein:1.
Life support devices or systems are devices or systems which, (a) are intended for surgical implant into the body, or (b) support or sustain life, or (c) whose failure to perform when properly used in accordance with instructions for use provided in the labeling, can be reasonably expected to result in significant injury to the user.		2. A critical component is any component of a life support device or system whose failure to perform can be reasonably expected to cause the failure of the life support device or system, or to affect its safety or effectiveness.

ANTI-COUNTERFEITING POLICY

Fairchild Semiconductor Corporation's Anti-Counterfeiting Policy. Fairchild's Anti-Counterfeiting Policy is also stated on our external website, www.fairchildsemi.com, under Sales Support.

Counterfeiting of semiconductor parts is a growing problem in the industry. All manufacturers of semiconductor products are experiencing counterfeiting of their parts. Customers who inadvertently purchase counterfeit parts experience many problems such as loss of brand reputation, substandard performance, failed applications, and increased cost of production and manufacturing delays. Fairchild is taking strong measures to protect ourselves and our customers from the proliferation of counterfeit parts. Fairchild strongly encourages customers to purchase Fairchild parts either directly from Fairchild or from Authorized Fairchild Distributors who are listed by country on our web page cited above. Products customers buy either from Fairchild directly or from Authorized Fairchild Distributors are genuine parts, have full traceability, meet Fairchild's quality standards for handling and storage and provide access to Fairchild's full range of up-to-date technical and product information. Fairchild and our Authorized Distributors will stand behind all warranties and will appropriately address any warranty issues that may arise. Fairchild will not provide any warranty coverage or other assistance for parts bought from Unauthorized Sources. Fairchild is committed to combat this global problem and encourage our customers to do their part in stopping this practice by buying direct or from authorized distributors.

EXPORT COMPLIANCE STATEMENT

These commodities, technology, or software were exported from the United States in accordance with the Export Administration Regulations for the ultimate destination listed on the commercial invoice. Diversion contrary to U.S. law is prohibited.

U.S. origin products and products made with U.S. origin technology are subject to U.S. Re-export laws. In the event of re-export, the user will be responsible to ensure the appropriate U.S. export regulations are followed.