

# 65 W TYPE-C PD3.0 / PPS Charger Solution with FUSB15101 Evaluation Board User's Manual

## EVBUM2819/D

### SPECIFICATION

onsemi's Device	Application	Input Voltage	Output Power	Topology	I/O Isolation
NCP1345Q01 NCP4307FASNT1G FUSB15101 FCMT250N65S3 FDMS86180 NTTFS4C02NTAG	Smart phone, PAD and NB adapter supporting PD3.0/PPS protocol	90 Vac to 264 Vac	65 W	Flyback	Isolated (3 kV)

	PD Output Specification	PPS Output Specification
Output Voltage	5 V, 9 V, 12 V, 15 V, 20 V	3 V – 21 V
Nominal Current	5 V / 3 A, 9 V / 3 A, 12 V / 3 A, 15 V / 3 A, 20 V / 3.25 A	3 A
Max Current	5 V / 3 A, 9 V / 3 A, 12 V / 3 A, 15 V / 3 A, 20 V / 3.25 A	3 A
Min Current	zero	zero

Avg. Efficiency	>92% @ 20 V 3.25 A at board end, 115 & 230 Vac
Ripple	<80 mV
Standby Power	35 mW @ 5 V & 230 Vac (No cable plug in)
Power Density	1.62 W/cm <sup>3</sup>
Protection	Adaptive UVP, OVP, OVP, SCP, OTP
PCBA Size	46 mm x 46 mm x 19 mm

### CIRCUIT DESCRIPTION

This evaluation board user's manual describes a 65 W, Type C interface PD3.0, universal AC input, constant voltage power supply intended for smart phone, PAD and NB adaptor supporting PD3.0 or PPS protocol, where isolation from the AC mains is required, and low cost, high efficiency, and low standby power are essential.

The featured power supply is a simple QR flyback topology utilizing **onsemi's** NCP1345 HF PWM controller, NCP4307 synchronous rectified controller, FDMS86180 synchronous MOSFET and NTTFS4C02 Switch MOSFET. This Design Note provides the complete circuit schematic details, PCB and BOM for 65 W Type C Interface PD3.0 Power adapter solution which supports PD output (5 V / 3 A, 9 V / 3 A, 12 V / 3 A, 15 V / 3 A, 20 V / 3.25 A).

This design combined with **onsemi's** FUSB15101 PD3.0 protocol controller to provide PD3.0 and PPS functions.

This design also proposes a dual auxiliary power supply to supply PWM controller, the PWM controller is supplied by high voltage auxiliary voltage at low output voltage and supplied by low voltage auxiliary voltage at high output voltage.

NCP1345 is next generation of NCP1342 HF QR controller, it provides precise primary CC also precise primary OVP protection, built in external dual Vcc circuit, improved jittering function which eliminated large output ripple also adaptive gate drive to reduce secondary voltage stress.

This design also uses NCP4307 synchronous rectified controller which eliminated external Vcc circuit at low output, also placed on high side or low side.

# EVBUM2819/D

## KEY FEATURES & PERFORMANCES

- Universal AC input range (90 – 264 Vac)
- Very low standby (5 V & 230 Vac) power consumption with no cable plug in
- Very low ripple and noise
- Inherent OVP,SCP and OCP protection
- High operation frequency up to 190 kHz at 230 V and full load
- High power density (1.62 W/cm<sup>3</sup>)
- Quick switching off FET while unplugging cable and switching on FET at Vbus dropping to 5 V while plugging cable again
- Quasi-Resonant current mode control with Valley Switching
- Valley lockout avoids audible noise at valley jumping operation
- Support TYPE-C PD3.0 & PPS protocol
- Adaptive Output OVP and UVP
- Open loop protection
- PCBA size: 46 mm x 46 mm x 19 mm

## BOARD PHOTOS



Figure 1. Profile of 65 W TYPE-C PD Adapter Solution

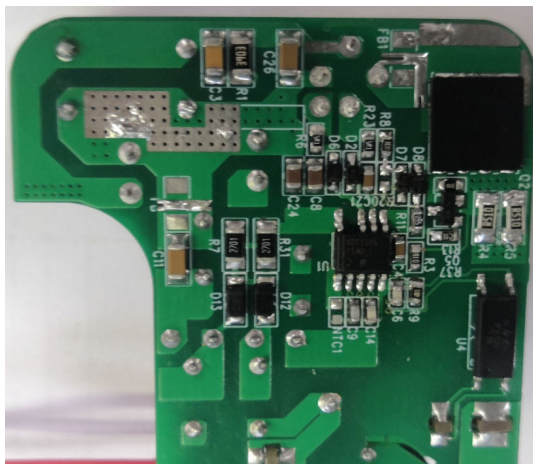

Figure 2. Side View 1 of Demoboard

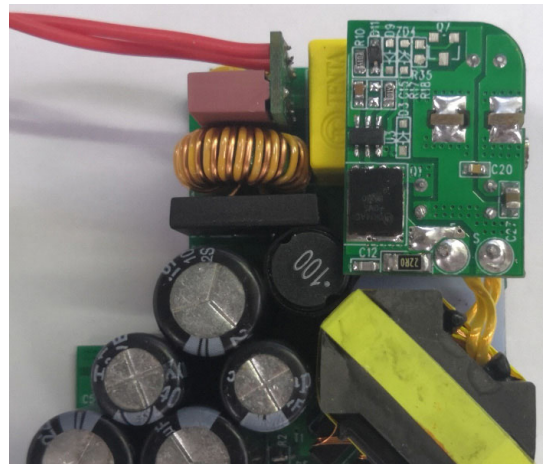

Figure 3. Side View 1 of Demoboard

# EVBUM2819/D

## CIRCUIT SCHEMATIC

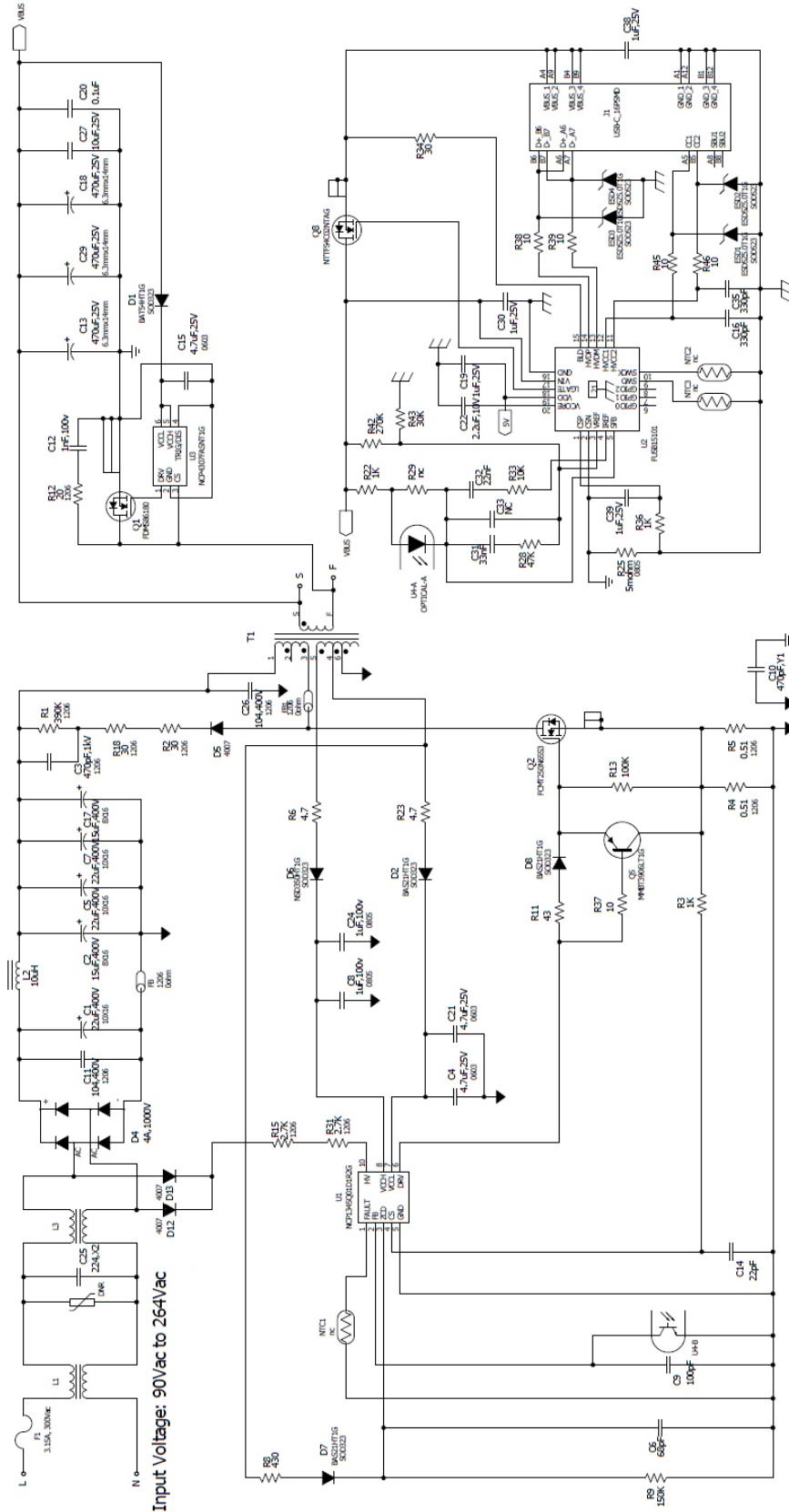

Figure 4. Circuit Schematic (PFC)

PCB

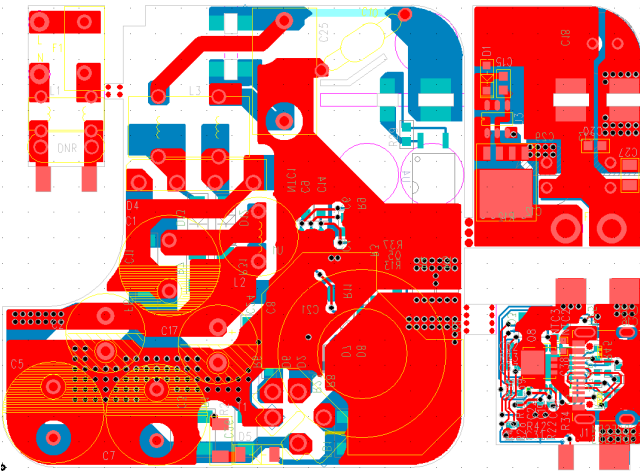

Figure 5. Top View of Mainboard's PCB

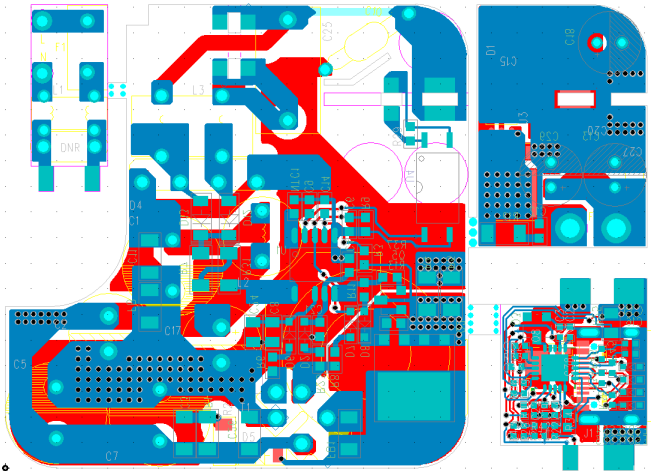

Figure 6. Bottom View of Mainboard's PCB

T1 TRANSFORMER DESIGNS (AVAILABLE FROM WURTH ELECTRONIC)

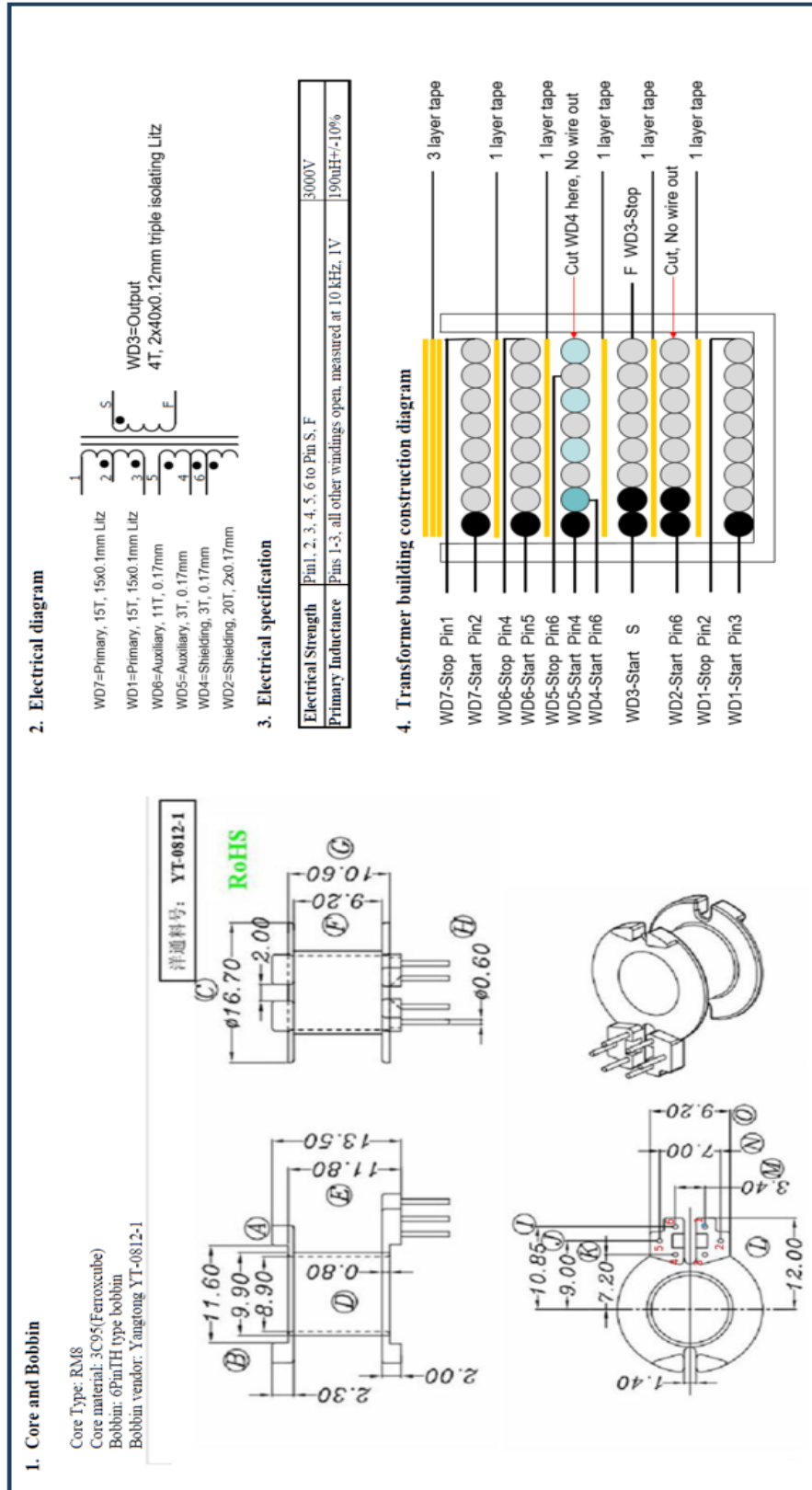

Figure 7. Transformer Specification

# EVBUM2819/D

## STANDBY POWER AT 5 V OUTPUT (CABLE UNPLUG) @ 90 Vac TO 264 Vac INPUT

(Test condition: all efficiency are tested at board end)

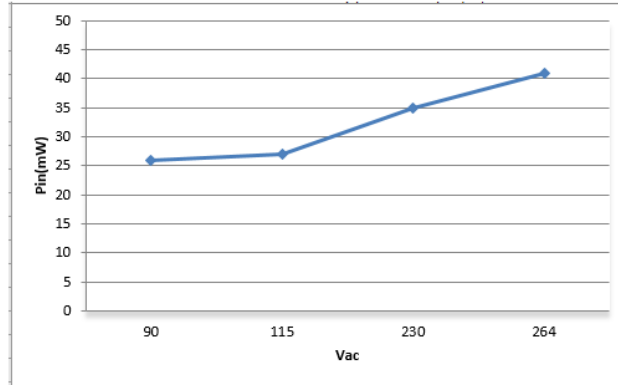

Figure 8.

## COC V5 TIER2 SPECIFICATION AND AVERAGE/LIGHT LOAD EFFICIENCY

(Test condition: all efficiency are tested at board end)

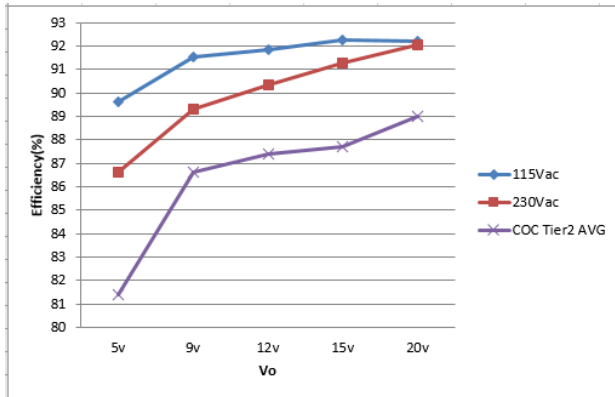

Figure 9. Avg Efficiency vs. COC V5 Tier2

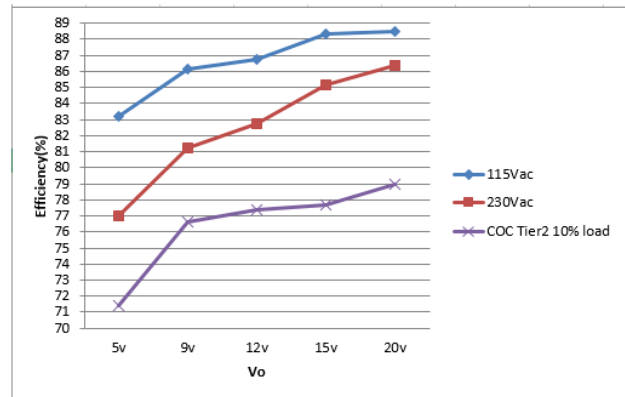

Figure 10. 10% Efficiency vs. COC V5 Tier2

**EFFICIENCY VS. OUTPUT LOAD CURVES**

(Test condition: all efficiency are tested at board end)

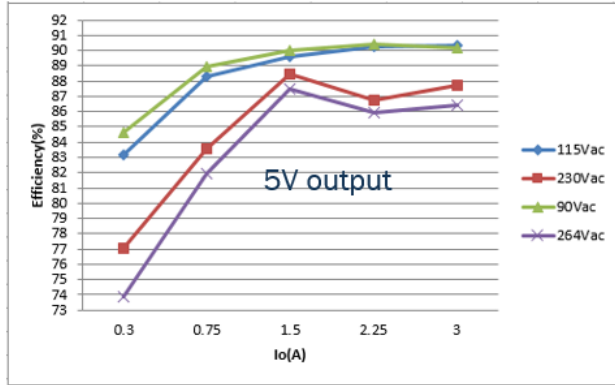

Figure 11. 5V Output

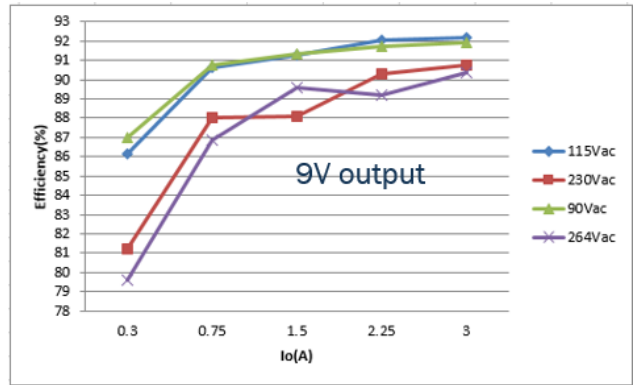

Figure 12. PD\_9V Output

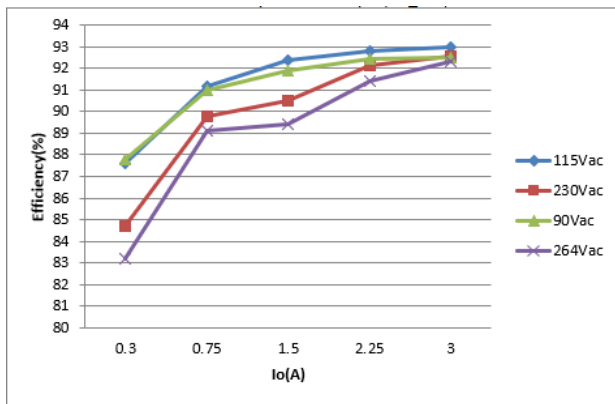

Figure 13. PD\_12V Output

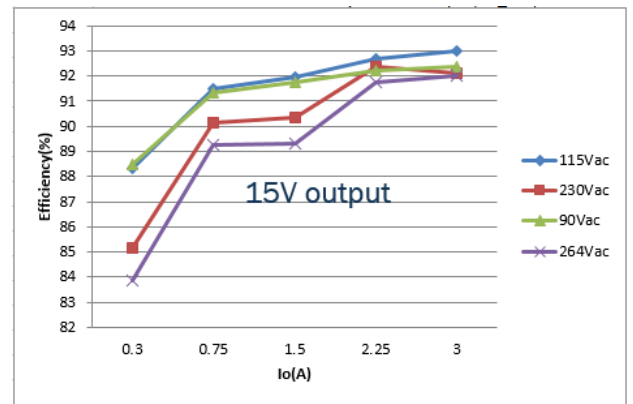

Figure 14. PD\_15V Output

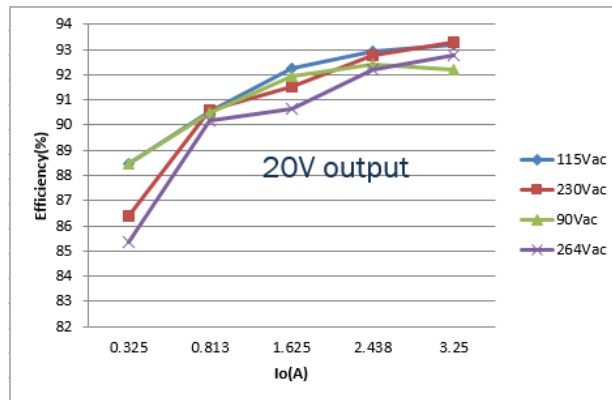

Figure 15. PD\_20V Output

# EVBUM2819/D

## PD VOLTAGE CHANGE

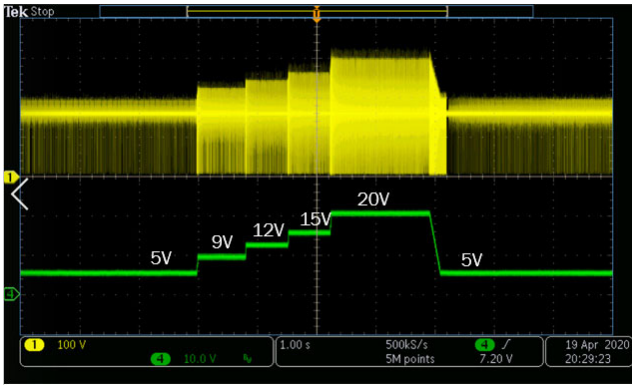

Figure 16. 115 Vac, No Load  
(CH1: Vds, CH4: Vo)

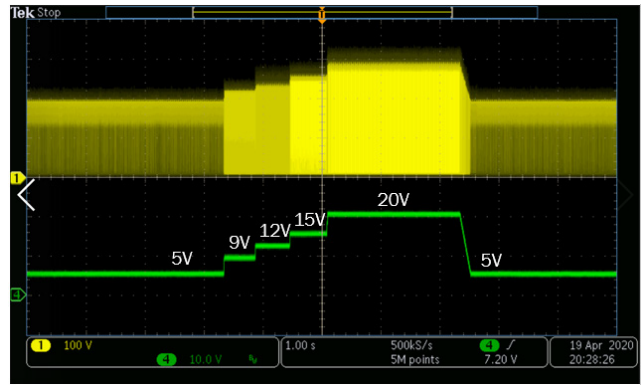

Figure 17. 115 Vac, 3 A Load  
(CH1: Vds, CH4: Vo)

## PRIMARY AND SEC. FET STRESS AT 264 Vac & 3.25 A

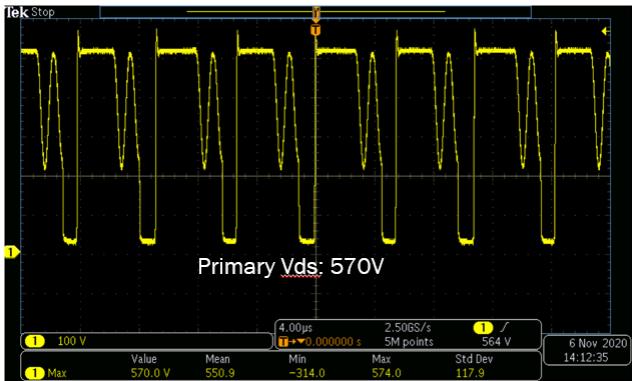

Figure 18.

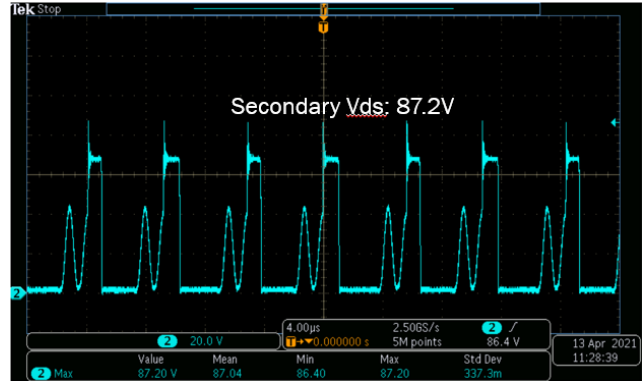

Figure 19.

## SYN. DRIVE DURING LOAD TRANSITION AT 264 V

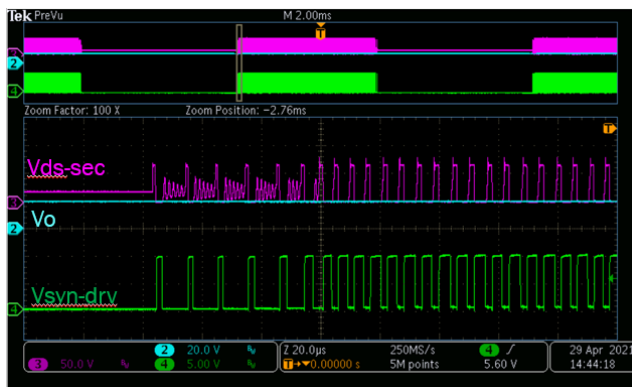

Figure 20. 20 V, 0 to 3 A



Figure 21. 20 V, 3 A to 0



# EVBUM2819/D

## OUTPUT RIPPLE @ 90 Vac INPUT

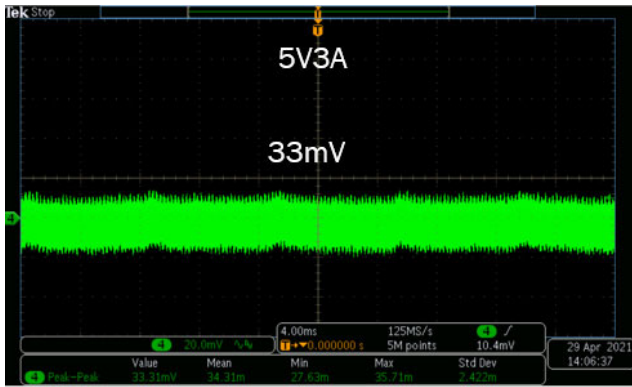

Figure 22. 5 V 3 A Output (CH4: Vo)

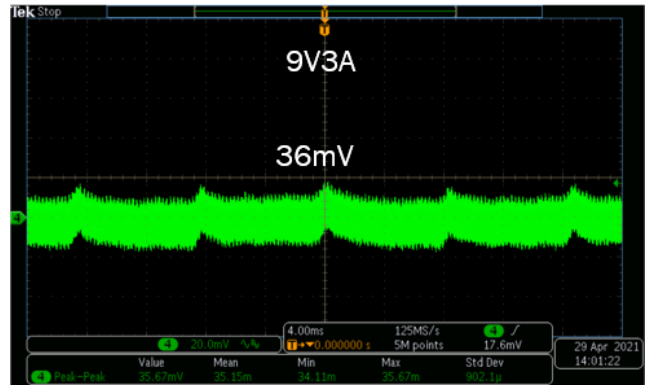

Figure 23. 9 V 3 A Output (CH4: Vo)

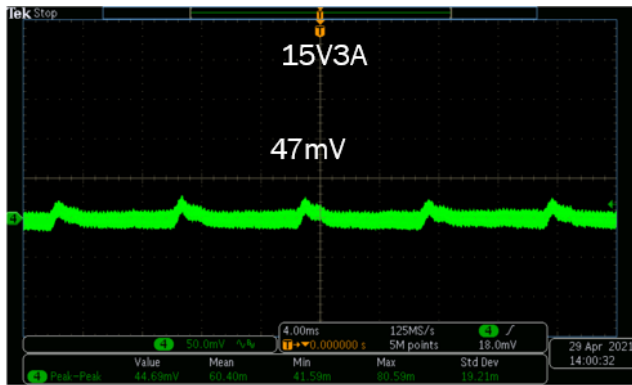

Figure 24. 15 V 3 A Output (CH4: Vo)

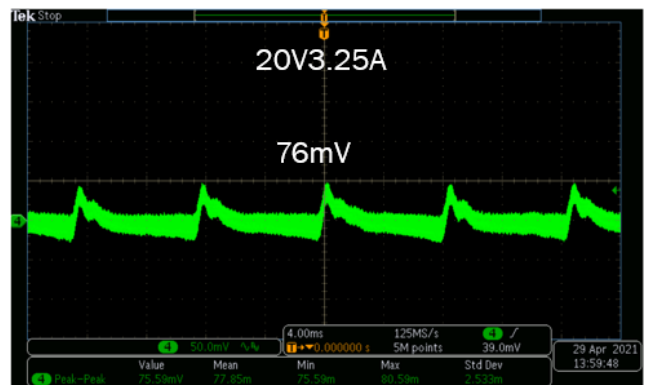

Figure 25. 20 V 3 A Output (CH4: Vo)

SKIP RIPPLE @ LOW OUTPUT & HIGH LINE

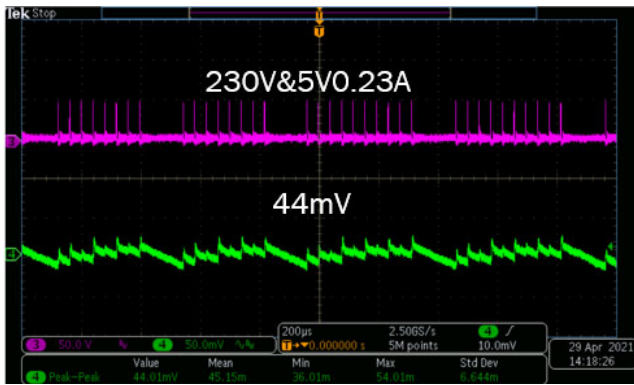

Figure 26. 5 V Output (CH4: Vo)

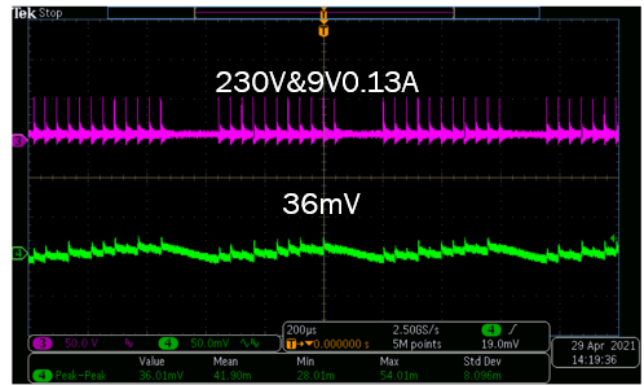

Figure 27. 9 V Output (CH4: Vo)

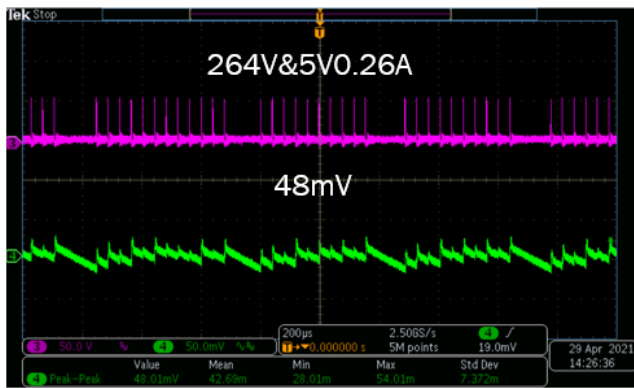

Figure 28.

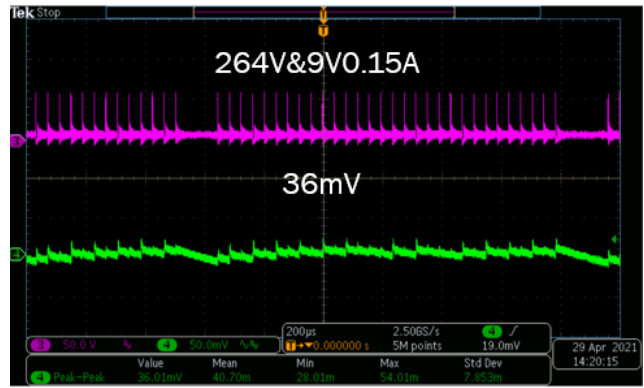

Figure 29.

DYNAMIC TEST FROM 0.1 TO FULL LOAD

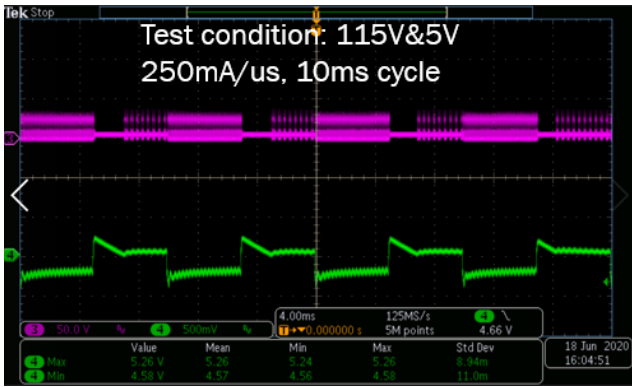

Figure 30. 5 V (CH3: Vds\_sec, CH4: Vo)

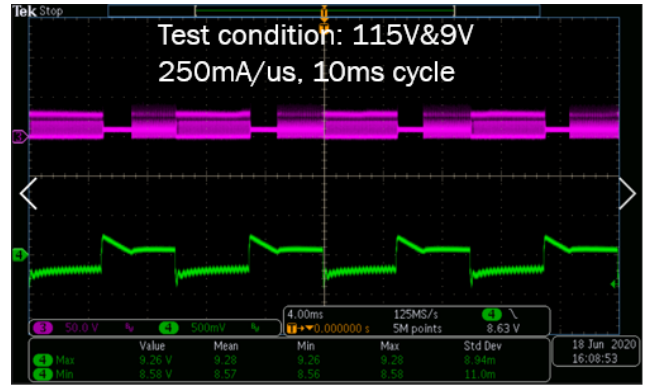

Figure 31. 9 V (CH3: Vds\_sec, CH4: Vo)

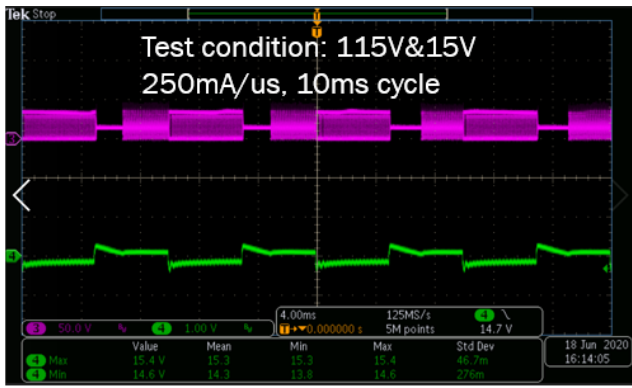

Figure 32. 15 V (CH3: Vds\_sec, CH4: Vo)

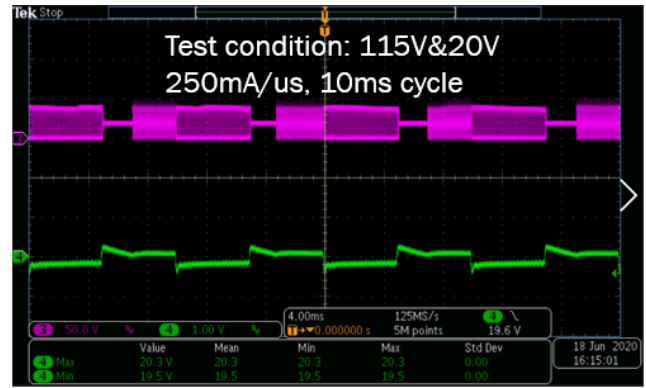

Figure 33. 20 V (CH3: Vds\_sec, CH4: Vo)

DYNAMIC TEST FROM 0.1 TO HALF LOAD

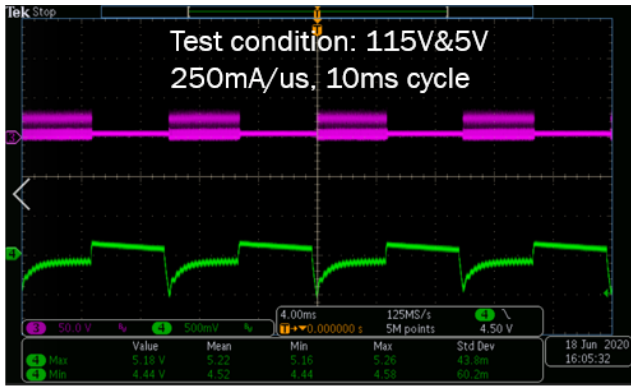

Figure 34. 5 V (CH3: Vds\_sec, CH4: Vo)

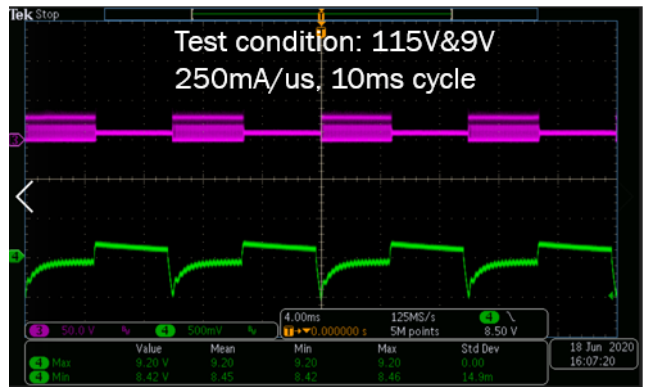

Figure 35. 9 V (CH3: Vds\_sec, CH4: Vo)

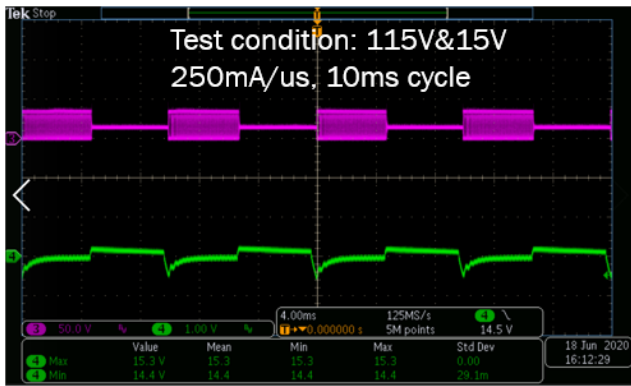

Figure 36. 15 V (CH3: Vds\_sec, CH4: Vo)

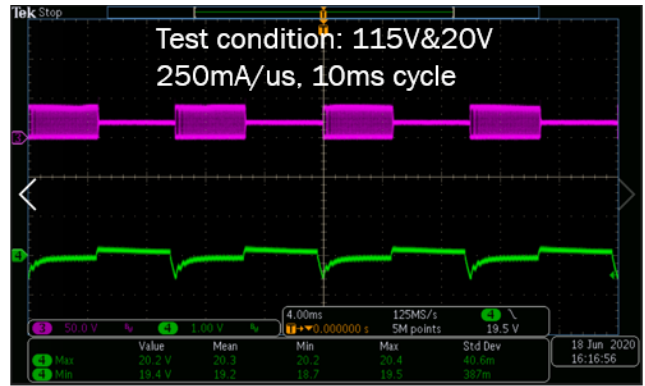

Figure 37. 20 V (CH3: Vds\_sec, CH4: Vo)

OPERATION FREQUENCY TEST AT 20 V OUTPUT

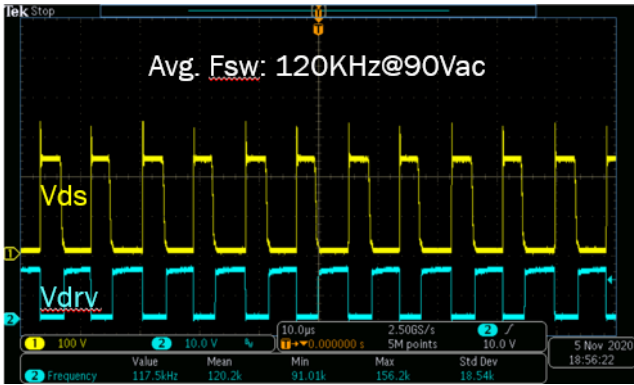

Figure 38. 90 Vac (CH1: Vds, CH2: Vdrv)

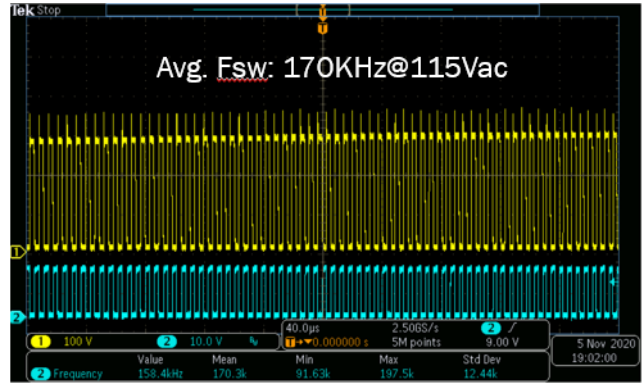

Figure 39. 115 Vac (CH1: Vds, CH2: Vdrv)

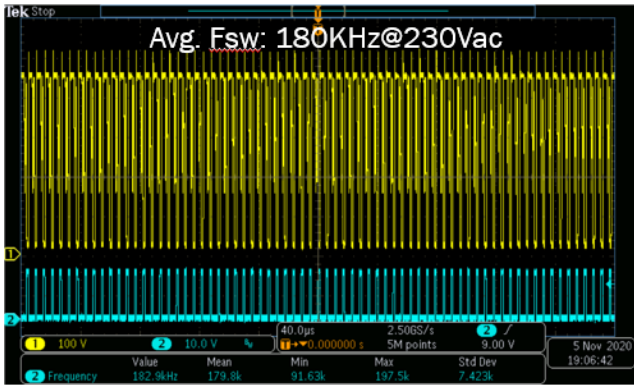

Figure 40. 230 Vac (CH1: Vds, CH2: Vdrv)

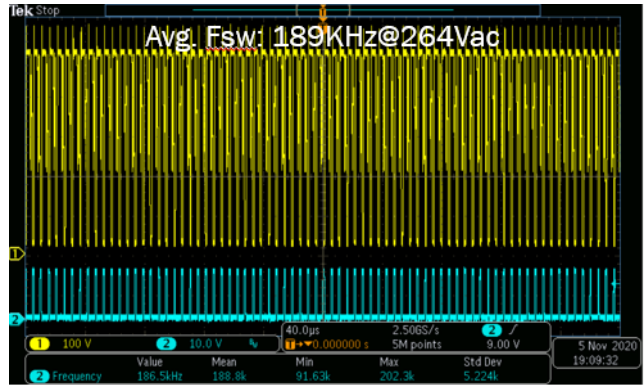

Figure 41. 264 Vac (CH1: Vds, CH2: Vdrv)

SHORT CIRCUIT PROTECTION AND  $T_{ovld}$ , Tauto-recovery TIME

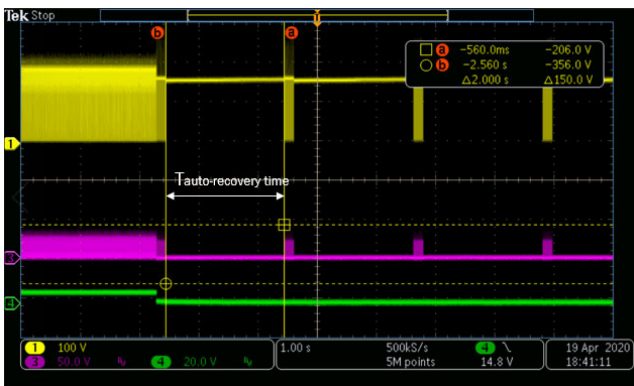

Figure 42. (CH1: Vdrain, CH3: Vsec-ds, CH4: Vo)



Figure 43. (CH1: Vdrain, CH3: Vsec-ds, CH4: Vo)

PRIMARY AND SEC. FET STRESS DURING SCP AND STARTUP

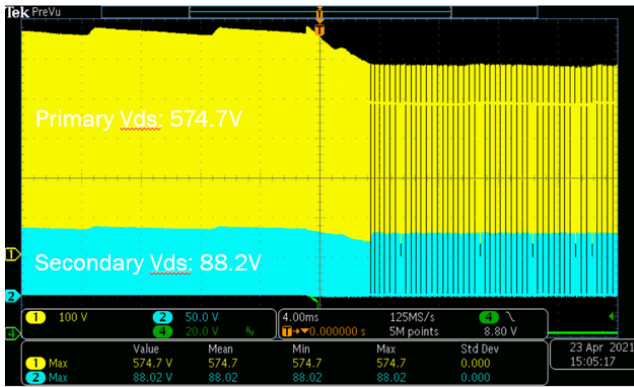

Figure 44. SCP at 264 Vac Input, 20 V 3.25 A Output (CH1: Vds, CH2: Vds\_sec, CH4: Vo)

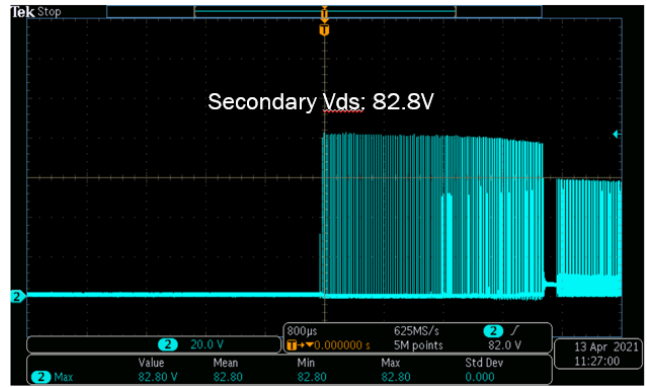

Figure 45. Startup at 264 Vac Input, 5 V 3 A Output (CH2: Vds\_sec)

OVP & X2 DISCHARGE TEST

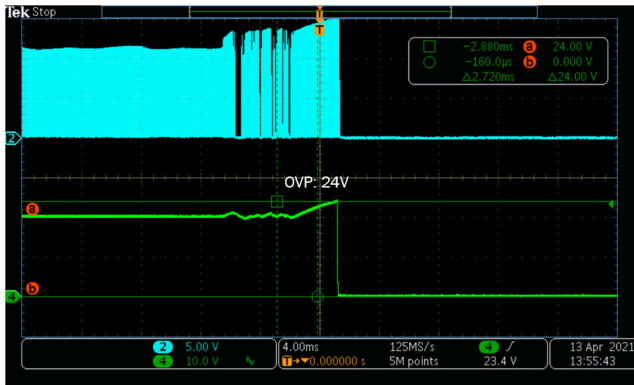

Figure 46. OVP at 115 Vac Input, 20 V 3.25 A Output (CH2: Vzcd, CH4: Vo)

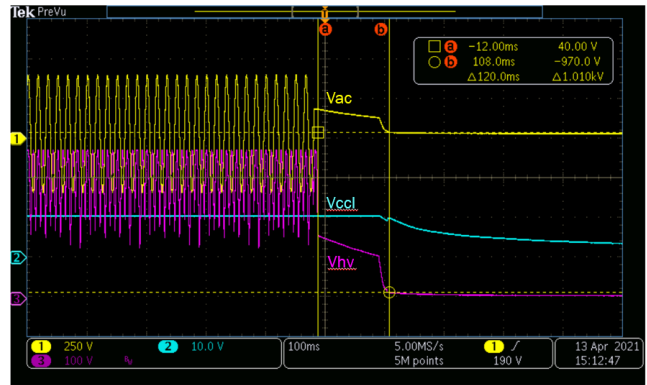

Figure 47. Plug Out AC at 264 Vac Input, 20 V Output (CH1: Vac, CH2: Vccl, CH3: Vhv)



THERMAL IMAGE @ 20 V 3.25 A OUTPUT

Table 1.

Input	Component Side	Back Side
90 Vac	<p>FLUKE 84.3°C 自动 2 118.1 最大 117.5 最小 25.5 73.6 25.8 ε=0.95 BG=26.4 T=100% 9/29/16 03:49:06 PM</p>	<p>FLUKE 78.7°C 自动 2 107.0 最大 106.3 最小 23.6 30.5 22.9 ε=0.95 BG=26.4 T=100% 9/29/16 03:48:21 PM</p>
115 Vac	<p>FLUKE 81.0°C 自动 2 97.7 最大 97.2 最小 25.2 34.6 23.4 ε=0.95 BG=26.4 T=100% 9/29/16 12:32:38 PM</p>	<p>FLUKE 71.2°C 自动 2 97.7 最大 96.7 最小 22.2 59.6 21.7 ε=0.95 BG=26.4 T=100% 9/29/16 12:32:12 PM</p>
230 Vac	<p>FLUKE 71.6°C 自动 2 98.5 最大 97.4 最小 22.9 53.9 22.4 ε=0.95 BG=26.4 T=100% 9/29/16 01:16:44 PM</p>	<p>FLUKE 63.3°C 自动 2 103.0 最大 102.1 最小 21.1 56.0 20.1 ε=0.95 BG=26.4 T=100% 9/29/16 01:16:22 PM</p>
264 Vac	<p>FLUKE 71.1°C 自动 2 108.0 最大 106.8 最小 21.9 54.5 21.1 ε=0.95 BG=26.4 T=100% 9/29/16 02:05:50 PM</p>	<p>FLUKE 63.5°C 自动 2 115.0 最大 115.6 最小 21.7 29.9 20.4 ε=0.95 BG=26.4 T=100% 9/29/16 02:05:24 PM</p>

# EVBUM2819/D

## LPS (LIMITED POWER SOURCE) TEST RESULT

### Output Voltage & Current

- PDO: 5 V 3 A, 9 V 3 A, 12 V 3 A, 15 V 3 A, 20 V 3.25 A

LPS requirement: <8 A and <100 W

- 5 V, 9 V, 12 V, 3 A < Io\_lps < 8 A
- 15 V, 3 A < Io\_lps < 6.67 A
- 20 V, 3.25 A < Io\_lps < 5 A

**Table 2. LPS TEST RESULT**

	<b>3.6 V</b>	<b>5 V</b>	<b>9 V</b>	<b>12 V</b>	<b>15 V</b>	<b>20 V</b>
90 Vac	4.5 A	4.5 A	4.3 A	4.4 A	4.37 A	4.4 A
115 Vac	4.5 A	4.5 A	4.3 A	4.39 A	4.36 A	4.31 A
230 Vac	4.5 A	4.5 A	4.3 A	4.37 A	4.36 A	4.3 A
264 Vac	4.5 A	4.5 A	4.3 A	4.37 A	4.34 A	4.27 A



# EVBUM2819/D

## EMI

### EMI Test at 230 Vac & Full Load

#### EMI TEST REPORT

Organization:	Operator:	EUT:
Place:	Time: 2021/4/28/15:16	Test equipment: KH3962
Detector: PK+AV	Test-time(ms): 30	SN: 620883
Limit: EN55022B	Transductor(PK/AV): PK / AV	JZ: 2,15,721
Remark:		

Start(MHz)	End(MHz)	Step(MHz)
0.150	2.000	0.002
2.000	10.000	0.010
10.000	30.000	0.025

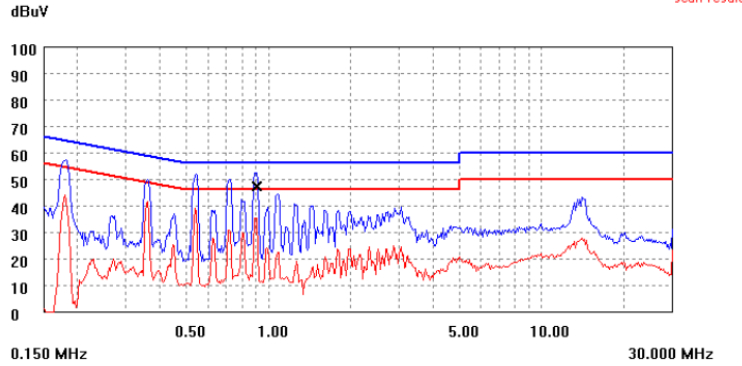

(QP)	freq(MHz)	lev(dBuV)	Lim(dBuV)	Δ(lev-Lim)
	0.906	47.4	56.0	-8.6

Figure 48. Line

#### EMI TEST REPORT

Organization:	Operator:	EUT:
Place:	Time: 2021/4/28/15:11	Test equipment: KH3962
Detector: PK+AV	Test-time(ms): 30	SN: 620883
Limit: EN55022B	Transductor(PK/AV): PK / AV	JZ: 2,15,700
Remark:		

Start(MHz)	End(MHz)	Step(MHz)
0.150	2.000	0.002
2.000	10.000	0.010
10.000	30.000	0.025

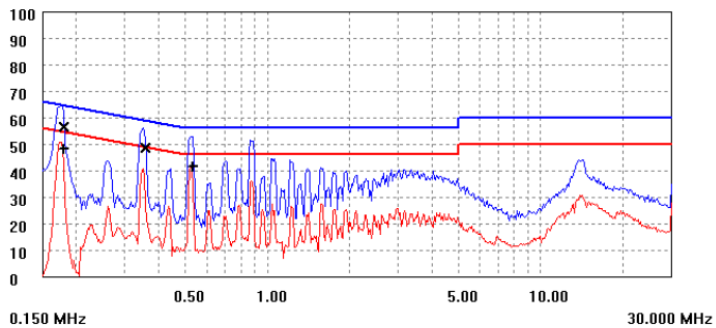

(QP)	freq(MHz)	lev(dBuV)	Lim(dBuV)	Δ(lev-Lim)
	0.179	56.4	64.5	-8.1
	0.359	48.5	58.8	-10.2
(AV)	freq(MHz)	lev(dBuV)	Lim(dBuV)	Δ(lev-Lim)
	0.179	48.0	54.5	-6.5
	0.533	41.7	46.0	-4.3

Figure 49. Neutral

# EVBUM2819/D

## EMI Test at 115 Vac & Full Load

### EMI TEST REPORT

parameter		
Organization:	Operator:	EUT:
Place:	Time: 2021/4/28/15:23	Test equipment: KH3962
Detector: PK+AV	Test-time[ms]: 30	SN: 620883
Limit: EN55022B	Transductor(PK/AV): PK / AV	JZ: 2,15,711
Remark:		
freq, step		
Start(MHz)	End(MHz)	Step(MHz)
0.150	2.000	0.002
2.000	10.000	0.010
10.000	30.000	0.025
scan result		
dBuV		

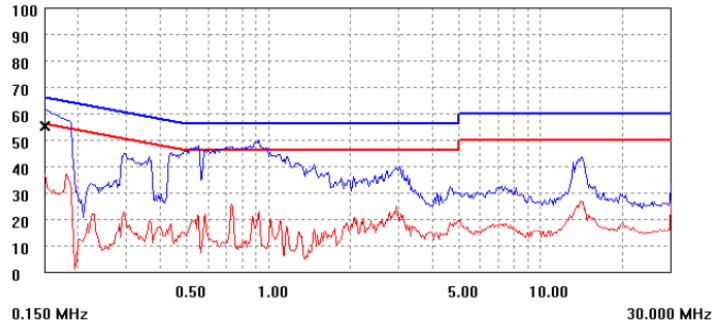

final test			
(QP)	freq(MHz)	lev(dBuV)	Lim(dBuV)
	0.150	55.1	66.0
			$\Delta$ (lev-Lim)
			-10.9

Figure 50. Line

### EMI TEST REPORT

parameter		
Organization:	Operator:	EUT:
Place:	Time: 2021/4/28/15:28	Test equipment: KH3962
Detector: PK+AV	Test-time[ms]: 30	SN: 620883
Limit: EN55022B	Transductor(PK/AV): PK / AV	JZ: 2,15,706
Remark:		
freq, step		
Start(MHz)	End(MHz)	Step(MHz)
0.150	2.000	0.002
2.000	10.000	0.010
10.000	30.000	0.025
scan result		
dBuV		

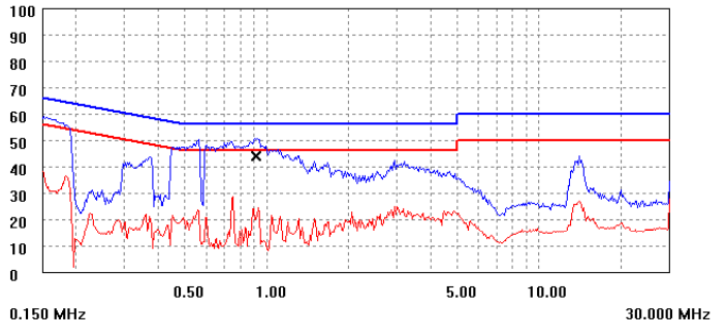

final test			
(QP)	freq(MHz)	lev(dBuV)	Lim(dBuV)
	0.916	43.9	56.0
			$\Delta$ (lev-Lim)
			-12.1

Figure 51. Neutral

# EVBUM2819/D

## BOM

**Table 3. BOM**

Item	Qty	Reference	Type	Part Name	MFR	Value	Package	Description
1	1	C20	Ceramic Capacitor	/885012206095	603	Würth	0.1 $\mu$ F	Capacitor, Ceramic, 50 V, 10%
2	1	C9	Ceramic Capacitor	/885012206077	603	Würth	101	Capacitor, Ceramic, 50 V, 10%
3	2	C11, C26	Ceramic Capacitor	C3216X7T2W104K	1206	TDK	104, 400 V	Capacitor, Ceramic, SMD, 5%
4	1	C27	Ceramic Capacitor	C2012X5R1E106KT000N	C0805	TDK	10 $\mu$ F, 25 V	Capacitor, Ceramic, 25 V, 10%
5	1	C12	Ceramic Capacitor	/885012006085	603	Würth	1 nF, 100 V	Capacitor, Ceramic, SMD, 5%
6	2	C8, C24	Ceramic Capacitor	C2012X7S2A105K	805	TDK	1 $\mu$ F, 100 V	Capacitor, Ceramic, 100 V, 10%
7	4	C19 C30, C38-39	Ceramic Capacitor	GRM155R61E105KA12D	402	muRata	1 $\mu$ F, 25 V	Capacitor, Ceramic, 25 V, 10%
8	1	C22	Ceramic Capacitor	/885012105013	402	Würth	2.2 $\mu$ F, 10 V	Capacitor, Ceramic, 10V, 10%
9	1	C25	X2 Capacitor	MP2224KGC3XLC	THT, 10 mm, 13 mm x 6 mm x 12 mm	SRD	224, X2	X2 capacitor, Safety standard approved, 10%
10	1	C32	Ceramic Capacitor	/885012205052	402	Würth	22 nF	Capacitor, Ceramic, 50 V, 10%
11	1	C14	Ceramic Capacitor	/885012006053	603	Würth	22 pF	Capacitor, Ceramic, 50 V, 10%
12	2	C16, C35	Ceramic Capacitor	/885012205058	402	Würth	330 pF	Capacitor, Ceramic, 50 V, 10%
13	1	C31	Ceramic Capacitor	/885012205053	402	Würth	33 nF	Capacitor, Ceramic, 25 V, 10%
14	3	C4, C15, C21	Ceramic Capacitor	C1608X5R1E475K080AC	603	TDK	4.7 $\mu$ F, 25 V	Capacitor, Ceramic, 25 V, 10%
15	1	C3	Ceramic Capacitor	8,85342E+11	1206	Würth	470 pF, 1 kV	Capacitor, Ceramic, Chip, 5%
16	1	C10	Ceramic Capacitor	CS65-B2GA101KYNKA	Lead type	TDK	470 pF, Y1	HV Ceramic Capacitor,safety standard approved, 10%
17	1	C6	Ceramic Capacitor	/885012006056	603	Würth	68 pF	Capacitor, Ceramic, 50 V, 5%
18	1	C33	Ceramic Capacitor	Std	402	std	NC	Capacitor, Ceramic, 50 V, 10%
19	1	D4	Bridge rectifier	GBP410	GBP	LiteON	4 A, 1000 V	Bridge Rectifier, 1000 V, 4 A
20	1	DNR	Varistor	820573011	TH	Würth	10D471K	Varistor, 10D471K
21	3	D2, D7, D8	Switching diode	BAS21HT1G	SOD323	onsemi	0.2 A, 250 V	Switching diode, SMD
22	1	D1	Switching diode	BAT54HT1G	SOD323	onsemi	0.2 A, 30 V	Switching diode, SMD
23	1	D6	Switching diode	NSD350HT1G	SOD323	onsemi	0.2 A, 350 V	Switching diode, SMD
24	3	D12, D13, D5	Standard rectifier	4007	SOD123FL	std	0.8 A, 600 V	Standard Rectifier, 0.8 A, 600 V
25	1	FB	Ferrite bead	TBD	1206		0 $\Omega$	replaced by 0 $\Omega$
26	1	FB1	Ferrite bead	TBD	1206		0 $\Omega$	replaced by 0 $\Omega$
27	1	L1	Common filter	std	TH type	std	18 $\mu$ H	CM Filter, T6*3*3, Ni-Zn
28	1	L3	Common filter	T12*6*4	TH type	std	2.4 mH	CM Filter, T12*6*4, Mn-Zn
29	1	U2	Protocol controller	FUSB15101	DNF20-4x4	onsemi		
30	1	F1	Fuse	3691160000	Axial lead	Littlefuse	3.15 A, 300 Vac	Micro Fuse, 3.15 A/300 V
31	1	Q5	PNP Transistor	MMBT3906LT1G	SOT23	onsemi	0.2 A, 40 V	General PNP Transistor, SMD
32	1	U3	Syn. controller	NCP4307FASNT1G	TSOP6	onsemi		Syn. Rectified controller
33	1	U1	PWM controller	NCP1345Q01D1R2G	SOP9	onsemi		HF QR controller
34	1	NTC1	NTC	SDNT1608X104J4250HTF	603	Sunlord	nc	not solder
35	2	NTC2-3	NTC	SDNT1005X104J4250HTF	402	Shunlord	nc	not solder
36	1	U4	Optical coupler	FODM1009	LSOP4	onsemi (FSC)		optical coupler, standard SOP package
37	1	L2	Axial leaded fixed inductor	7447452100	8012	Würth	10 $\mu$ H	Axial leaded fixed inductor
38	1	Q2	MOSFET	FCMT250N65S3	THINKPAK-8X8	onsemi		MOSFET, NChan, 650 V
39	1	R37	Resistor	Std	603	Std	10 $\Omega$	Resistor, Chip, 1/10 W, 1%
40	4	R38-39, R45-46	Resistor	Std	402	Std	10 $\Omega$	Resistor, Chip, 1/16 W, 1%
41	1	R13	Resistor	Std	603	Std	100 k $\Omega$	Resistor, Chip, 1/10 W, 1%
42	1	R33	Resistor	Std	402	Std	10 k $\Omega$	Resistor, Chip, 1/16 W, 1%

# EVBUM2819/D

**Table 3. BOM (continued)**

Item	Qty	Reference	Type	Part Name	MFR	Value	Package	Description
43	1	R9	Resistor	Std	603	Std	150 k $\Omega$	Resistor, Chip, 1/10 W, 1%
44	1	R3	Resistor	Std	603	Std	1 k $\Omega$	Resistor, Chip, 1/10 W, 1%
45	2	R22, R36	Resistor	Std	402	Std	1 k $\Omega$	Resistor, Chip, 1/16 W, 1%
46	1	R42	Resistor	Std	402	Std	270 k $\Omega$	Resistor, Chip, 1/16 W, 1%
47	1	R34	Resistor	Std	603	Std	30 $\Omega$	Resistor, Chip, 1/10 W, 1%
48	1	R43	Resistor	Std	402	Std	30 k $\Omega$	Resistor, Chip, 1/16 W, 1%
49	2	R6, R23	Resistor	Std	603	Std	4,7 $\Omega$	Resistor, Chip, 1/10 W, 1%
50	1	R11	Resistor	Std	603	Std	43 $\Omega$	Resistor, Chip, 1/10 W, 1%
51	1	R8	Resistor	Std	603	Std	430 $\Omega$	Resistor, Chip, 1/10 W, 1%
52	1	R28	Resistor	Std	402	Std	47 k $\Omega$	Resistor, Chip, 1/16 W, 1%
53	1	R29	Resistor	Std	603	Std	nc	Resistor, Chip, 1/10 W, 1%
54	2	R4-5	Resistor	ERJ8BQFR051V	1206	Panasonic	0,51 $\Omega$	Resistor, Chip, 1/2 W, 1%
55	2	R15, R31	Resistor	Std	1206	Std	2,7 k $\Omega$	Resistor, Chip, 1/4 W, 1%
56	1	R12	Resistor	Std	1206	Std	20 $\Omega$	Resistor, Chip, 1/4 W, 1%
57	1	R2	Resistor	Std	1206	Std	62 $\Omega$	Resistor, Chip, 1/4 W, 1%
58	1	R1	Resistor	Std	1206	Std	390 k $\Omega$	Resistor, Chip, 1/4 W, 1%
59	1	R25	Resistor	ERJ6LWFR005V	805	PANASONIC	5 m $\Omega$	Resistor, Chip, 1/2 W, 1%
60	1	T1	Transformer	Jepuls	TH type	Jepuls		Ferroxcube, 3C95 RM8 core
61	2	C2, C17	Electrolytic capacitor	TH150L400F160A00H	8X16	CapXon	15 $\mu$ F, 400 V	size, 8 mm x 16 mm
62	3	C1, C5, C7	Electrolytic capacitor	TH220L400G160A	10X16	CapXon	22 $\mu$ F, 400 V	size, 10 mm x 16 mm
63	3	C13, C18, C29	Electrolytic solid capacitor	PX471M025E130P00HC	6.3mmx14mm	CapXon	470 $\mu$ F, 25 V	size: 6.3 mm x 14 mm
64	1	Q8	MOSFET	NTTFS4C02NTAG	u8L	onsemi		MOSFET, NChan, 3,4 m $\Omega$
65	1	Q1	MOSFET	FDMS86180	SO8FL	onsemi	3,2 m $\Omega$ , 100 V	MOSFET, NChan, 100 V
66	1	J1	USB Type C connector	CUS31738616001	SMD	CSCONN		Type C connector, SMT
67	4	ESD1-4	ESD	ESD5Z5.0T1G	SOD523	onsemi	5 V	ESD protection device

## REFERENCES

onsemi datasheet for NCP1345, NCP4307, FUSB15101, FCMT250N65, FDMS86180, NTTFS4C02  
onsemi Design Notes DN05043

**onsemi**, **Onsemi**, and other names, marks, and brands are registered and/or common law trademarks of Semiconductor Components Industries, LLC dba "**onsemi**" or its affiliates and/or subsidiaries in the United States and/or other countries. **onsemi** owns the rights to a number of patents, trademarks, copyrights, trade secrets, and other intellectual property. A listing of **onsemi**'s product/patent coverage may be accessed at [www.onsemi.com/site/pdf/Patent-Marking.pdf](http://www.onsemi.com/site/pdf/Patent-Marking.pdf). **onsemi** is an Equal Opportunity/Affirmative Action Employer. This literature is subject to all applicable copyright laws and is not for resale in any manner.

The evaluation board/kit (research and development board/kit) (hereinafter the "board") is not a finished product and is not available for sale to consumers. The board is only intended for research, development, demonstration and evaluation purposes and will only be used in laboratory/development areas by persons with an engineering/technical training and familiar with the risks associated with handling electrical/mechanical components, systems and subsystems. This person assumes full responsibility/liability for proper and safe handling. Any other use, resale or redistribution for any other purpose is strictly prohibited.

**THE BOARD IS PROVIDED BY ONSEMI TO YOU "AS IS" AND WITHOUT ANY REPRESENTATIONS OR WARRANTIES WHATSOEVER. WITHOUT LIMITING THE FOREGOING, ONSEMI (AND ITS LICENSORS/SUPPLIERS) HEREBY DISCLAIMS ANY AND ALL REPRESENTATIONS AND WARRANTIES IN RELATION TO THE BOARD, ANY MODIFICATIONS, OR THIS AGREEMENT, WHETHER EXPRESS, IMPLIED, STATUTORY OR OTHERWISE, INCLUDING WITHOUT LIMITATION ANY AND ALL REPRESENTATIONS AND WARRANTIES OF MERCHANTABILITY, FITNESS FOR A PARTICULAR PURPOSE, TITLE, NON-INFRINGEMENT, AND THOSE ARISING FROM A COURSE OF DEALING, TRADE USAGE, TRADE CUSTOM OR TRADE PRACTICE.**

**onsemi** reserves the right to make changes without further notice to any board.

You are responsible for determining whether the board will be suitable for your intended use or application or will achieve your intended results. Prior to using or distributing any systems that have been evaluated, designed or tested using the board, you agree to test and validate your design to confirm the functionality for your application. Any technical, applications or design information or advice, quality characterization, reliability data or other services provided by **onsemi** shall not constitute any representation or warranty by **onsemi**, and no additional obligations or liabilities shall arise from **onsemi** having provided such information or services.

**onsemi** products including the boards are not designed, intended, or authorized for use in life support systems, or any FDA Class 3 medical devices or medical devices with a similar or equivalent classification in a foreign jurisdiction, or any devices intended for implantation in the human body. You agree to indemnify, defend and hold harmless **onsemi**, its directors, officers, employees, representatives, agents, subsidiaries, affiliates, distributors, and assigns, against any and all liabilities, losses, costs, damages, judgments, and expenses, arising out of any claim, demand, investigation, lawsuit, regulatory action or cause of action arising out of or associated with any unauthorized use, even if such claim alleges that **onsemi** was negligent regarding the design or manufacture of any products and/or the board.

This evaluation board/kit does not fall within the scope of the European Union directives regarding electromagnetic compatibility, restricted substances (RoHS), recycling (WEEE), FCC, CE or UL, and may not meet the technical requirements of these or other related directives.

FCC WARNING – This evaluation board/kit is intended for use for engineering development, demonstration, or evaluation purposes only and is not considered by **onsemi** to be a finished end product fit for general consumer use. It may generate, use, or radiate radio frequency energy and has not been tested for compliance with the limits of computing devices pursuant to part 15 of FCC rules, which are designed to provide reasonable protection against radio frequency interference. Operation of this equipment may cause interference with radio communications, in which case the user shall be responsible, at its expense, to take whatever measures may be required to correct this interference.

**onsemi** does not convey any license under its patent rights nor the rights of others.

LIMITATIONS OF LIABILITY: **onsemi** shall not be liable for any special, consequential, incidental, indirect or punitive damages, including, but not limited to the costs of requalification, delay, loss of profits or goodwill, arising out of or in connection with the board, even if **onsemi** is advised of the possibility of such damages. In no event shall **onsemi**'s aggregate liability from any obligation arising out of or in connection with the board, under any theory of liability, exceed the purchase price paid for the board, if any.

The board is provided to you subject to the license and other terms per **onsemi**'s standard terms and conditions of sale. For more information and documentation, please visit [www.onsemi.com](http://www.onsemi.com).

## ADDITIONAL INFORMATION

### TECHNICAL PUBLICATIONS:

Technical Library: [www.onsemi.com/design/resources/technical-documentation](http://www.onsemi.com/design/resources/technical-documentation)  
onsemi Website: [www.onsemi.com](http://www.onsemi.com)

ONLINE SUPPORT: [www.onsemi.com/support](http://www.onsemi.com/support)

For additional information, please contact your local Sales Representative at [www.onsemi.com/support/sales](http://www.onsemi.com/support/sales)