

QORVO

SiC JFET Division

Is Now Part of

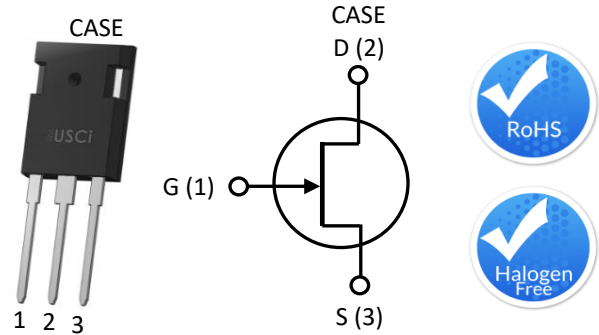
onsemi™

To learn more about onsemi™, please visit our website at
www.onsemi.com

onsemi and **onsemi** and other names, marks, and brands are registered and/or common law trademarks of Semiconductor Components Industries, LLC dba "**onsemi**" or its affiliates and/or subsidiaries in the United States and/or other countries. **onsemi** owns the rights to a number of patents, trademarks, copyrights, trade secrets, and other intellectual property. A listing of **onsemi** product/patent coverage may be accessed at www.onsemi.com/site/pdf/Patent-Marking.pdf. **onsemi** reserves the right to make changes at any time to any products or information herein, without notice. The information herein is provided "as-is" and **onsemi** makes no warranty, representation or guarantee regarding the accuracy of the information, product features, availability, functionality, or suitability of its products for any particular purpose, nor does **onsemi** assume any liability arising out of the application or use of any product or circuit, and specifically disclaims any and all liability, including without limitation special, consequential or incidental damages. Buyer is responsible for its products and applications using **onsemi** products, including compliance with all laws, regulations and safety requirements or standards, regardless of any support or applications information provided by **onsemi**. "Typical" parameters which may be provided in **onsemi** data sheets and/or specifications can and do vary in different applications and actual performance may vary over time. All operating parameters, including "Typicals" must be validated for each customer application by customer's technical experts. **onsemi** does not convey any license under any of its intellectual property rights nor the rights of others. **onsemi** products are not designed, intended, or authorized for use as a critical component in life support systems or any FDA Class 3 medical devices or medical devices with a same or similar classification in a foreign jurisdiction or any devices intended for implantation in the human body. Should Buyer purchase or use **onsemi** products for any such unintended or unauthorized application, Buyer shall indemnify and hold **onsemi** and its officers, employees, subsidiaries, affiliates, and distributors harmless against all claims, costs, damages, and expenses, and reasonable attorney fees arising out of, directly or indirectly, any claim of personal injury or death associated with such unintended or unauthorized use, even if such claim alleges that **onsemi** was negligent regarding the design or manufacture of the part. **onsemi** is an Equal Opportunity/Affirmative Action Employer. This literature is subject to all applicable copyright laws and is not for resale in any manner. Other names and brands may be claimed as the property of others.

Description

United Silicon Carbide, Inc offers the high-performance G3 SiC normally-on JFET transistors. This series exhibits ultra-low on resistance ($R_{DS(ON)}$) and gate charge (Q_G) allowing for low conduction and switching loss. The device normally-on characteristics with low $R_{DS(ON)}$ at $V_{GS} = 0\text{ V}$ is also ideal for current protection circuits without the need for active control, as well as for cascode operation.



Part Number	Package	Marking
UJ3N065025K3S	TO-247-3L	UJ3N065025K3S

Features

- ◆ Typical on-resistance $R_{DS(on),typ}$ of 25m Ω
- ◆ Voltage controlled
- ◆ Maximum operating temperature of 175°C
- ◆ Extremely fast switching not dependent on temperature
- ◆ Low gate charge
- ◆ Low intrinsic capacitance
- ◆ RoHS compliant
- ◆ AECQ Qualified

Typical Applications

- ◆ Over current protection circuits
- ◆ DC-AC inverters
- ◆ Switch mode power supplies
- ◆ Power factor correction modules
- ◆ Motor drives
- ◆ Induction heating

Maximum Ratings

Parameter	Symbol	Test Conditions	Value	Units
Drain-source voltage	V_{DS}		650	V
Gate-source voltage	V_{GS}	DC	-20 to +3	V
		AC ⁽¹⁾	-20 to +20	
Continuous drain current ⁽²⁾	I_D	$T_C = 25^\circ\text{C}$	85	A
		$T_C = 100^\circ\text{C}$	62	A
Pulsed drain current ⁽³⁾	I_{DM}	$T_C = 25^\circ\text{C}$	250	A
Power dissipation	P_{tot}	$T_C = 25^\circ\text{C}$	441	W
Maximum junction temperature	$T_{J,max}$		175	°C
Operating and storage temperature	T_J, T_{STG}		-55 to 175	°C
Max. lead temperature for soldering, 1/8" from case for 5 seconds	T_L		250	°C

(1) +20V AC rating applies for turn-on pulses <200ns applied with external $R_G > 1\Omega$.

(2) Limited by $T_{J,max}$

(3) Pulse width t_p limited by $T_{J,max}$

Electrical Characteristics ($T_J = +25^\circ\text{C}$ unless otherwise specified)

Typical Performance - Static

Parameter	Symbol	Test Conditions	Value			Units
			Min	Typ	Max	
Drain-source breakdown voltage	BV_{DS}	$V_{GS} = -20\text{V}, I_D = 1\text{mA}$	650			V
Total drain leakage current	I_D	$V_{DS} = 650\text{V},$ $V_{GS} = -20\text{V}, T_J = 25^\circ\text{C}$		10	60	μA
		$V_{DS} = 650\text{V},$ $V_{GS} = -20\text{V}, T_J = 175^\circ\text{C}$		40		
Total gate leakage current	I_G	$V_{GS} = -20\text{V}, T_J = 25^\circ\text{C}$		10	100	μA
		$V_{GS} = -20\text{V}, T_J = 175^\circ\text{C}$		38		
Drain-source on-resistance	$R_{DS(on)}$	$V_{GS} = 2\text{V}, I_D = 20\text{A},$ $T_J = 25^\circ\text{C}$		22		$\text{m}\Omega$
		$V_{GS} = 0\text{V}, I_D = 20\text{A},$ $T_J = 25^\circ\text{C}$		25	33	
		$V_{GS} = 2\text{V}, I_D = 20\text{A},$ $T_J = 175^\circ\text{C}$		38		
		$V_{GS} = 0\text{V}, I_D = 20\text{A},$ $T_J = 175^\circ\text{C}$		43		
Gate threshold voltage	$V_{G(th)}$	$V_{DS} = 5\text{V}, I_D = 70\text{mA}$	-14	-11.5	-6	V
Gate resistance	R_G	$f = 1\text{MHz}, \text{open drain}$		2.5		Ω

Typical Performance - Dynamic

Parameter	symbol	Test Conditions	Value			Units
			Min	Typ	Max	
Input capacitance	C_{iss}	$V_{DS} = 100V,$ $V_{GS} = -20V,$ $f = 100kHz$		2360		pF
Output capacitance	C_{oss}			290		
Reverse transfer capacitance	C_{rss}			282		
Effective output capacitance, energy related	$C_{oss(er)}$	$V_{DS} = 0V$ to 400V, $V_{GS} = -20V$		210		pF
Total gate charge	Q_G	$V_{DS}=400V, I_D = 60A,$ $V_{GS}=-18V$ to 0V		240		nC
Gate-drain charge	Q_{GD}			134		
Gate-source charge	Q_{GS}			24		
Turn-on delay time	$t_{d(on)}$	$V_{DS}=400V, I_D=60A,$ Gate Driver = -18V to 0V, $R_{G,EXT} = 1\Omega,$ Inductive Load, FWD: UJ3D06530TS $T_J = 25^\circ C$		11		ns
Rise time	t_r			64		
Turn-off delay time	$t_{d(off)}$			43		
Fall time	t_f			44		
Turn-on energy	E_{ON}			740		μJ
Turn-off energy	E_{OFF}			818		
Total switching energy	E_{TOTAL}			1558		
Turn-on delay time	$t_{d(on)}$		$V_{DS}=400V, I_D=60A,$ Gate Driver = -18V to 0V, $R_{G,EXT} = 1\Omega,$ Inductive Load, FWD: UJ3D06530TS $T_J = 150^\circ C$		11	
Rise time	t_r			62		
Turn-off delay time	$t_{d(off)}$			38		
Fall time	t_f			41		
Turn-on energy	E_{ON}			663		μJ
Turn-off energy	E_{OFF}			750		
Total switching energy	E_{TOTAL}			1413		

Thermal Characteristics

Parameter	symbol	Test Conditions	Value			Units
			Min	Typ	Max	
Thermal resistance, junction-to-case	$R_{\theta JC}$			0.26	0.34	$^\circ C/W$

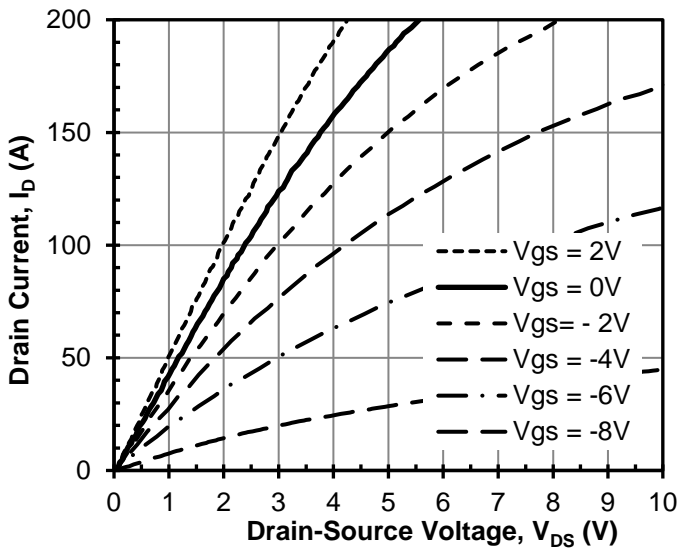
Typical Performance Diagrams


Figure 1 Typical output characteristics
at $T_J = -55^\circ\text{C}$

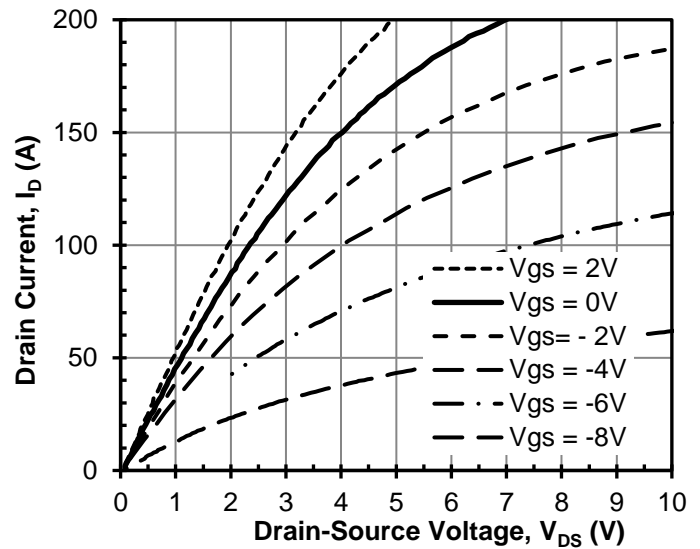


Figure 2 Typical output characteristics
at $T_J = 25^\circ\text{C}$

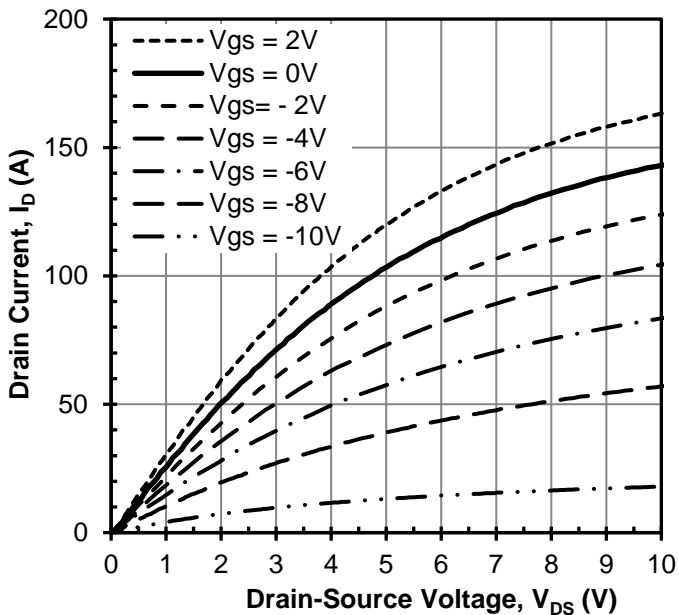


Figure 3 Typical output characteristics
at $T_J = 175^\circ\text{C}$

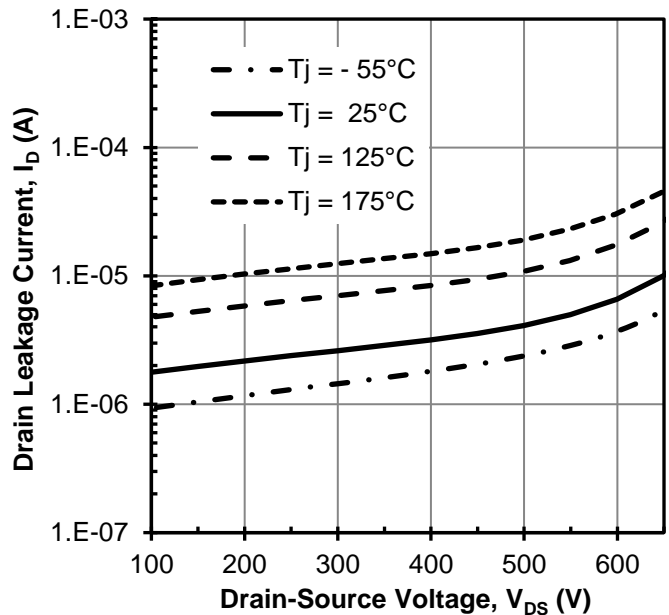


Figure 4 Typical drain-source leakage
at $V_{GS} = -20\text{V}$

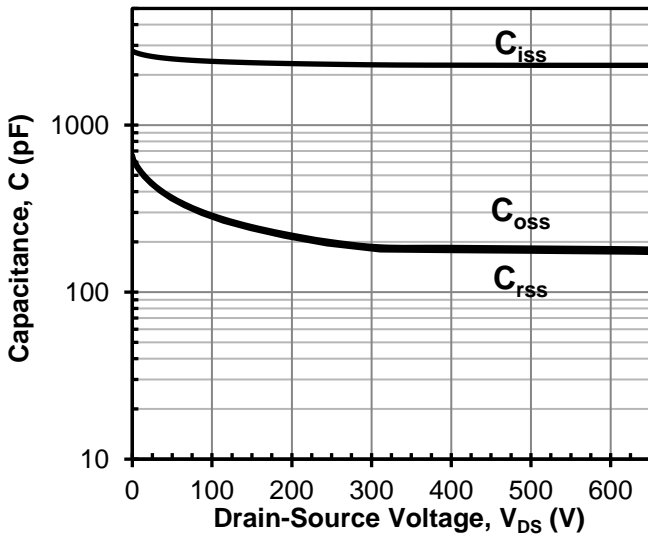


Figure 5 Typical capacitances at 100kHz and $V_{GS} = -20V$

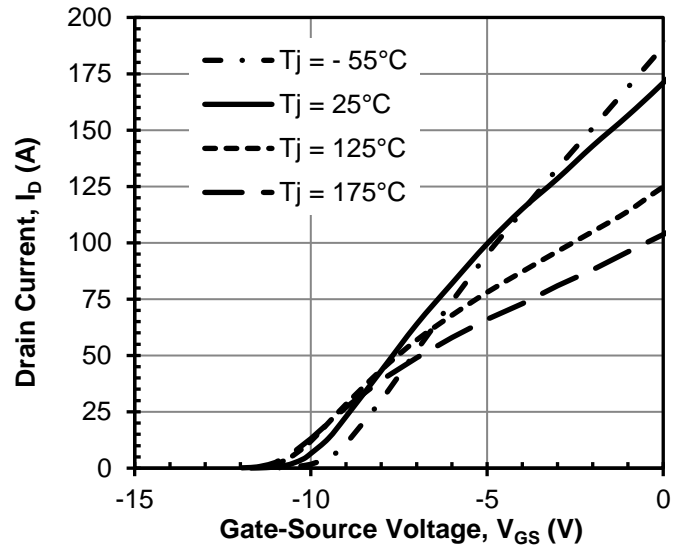


Figure 6 Typical transfer characteristics at $V_{DS} = 5V$

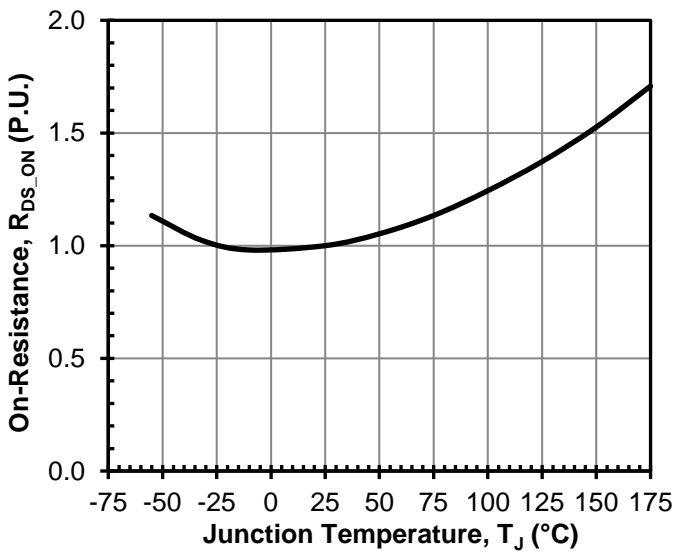


Figure 7 Normalized on-resistance vs. temperature at $V_{GS} = 0V$ and $I_D = 20A$

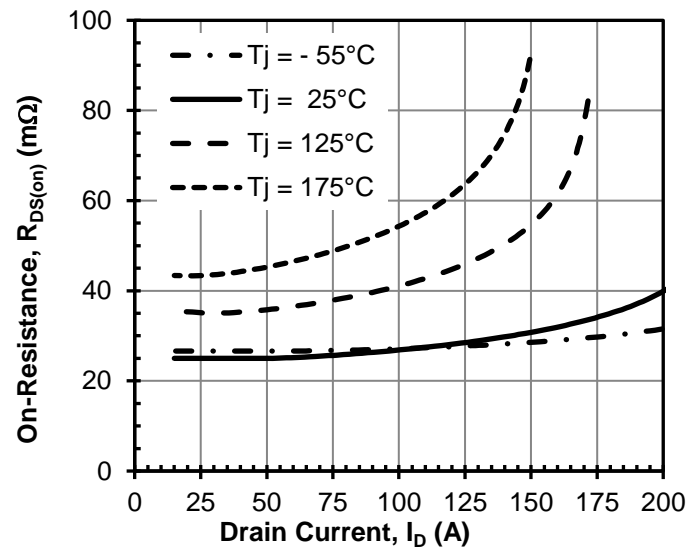


Figure 8 Typical drain-source on-resistance at $V_{GS} = 0V$

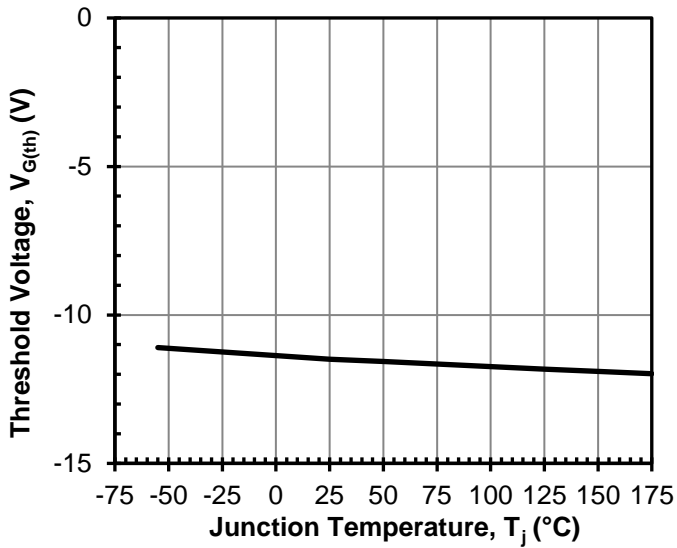


Figure 9 Threshold voltage vs. T_j
at $V_{DS} = 5V$ and $I_D = 70mA$

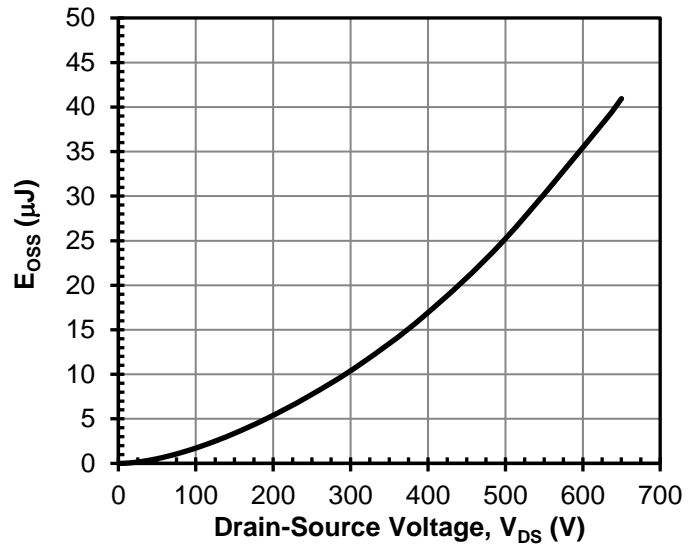


Figure 10 Typical stored energy in C_{oss}
at $V_{GS} = -20V$

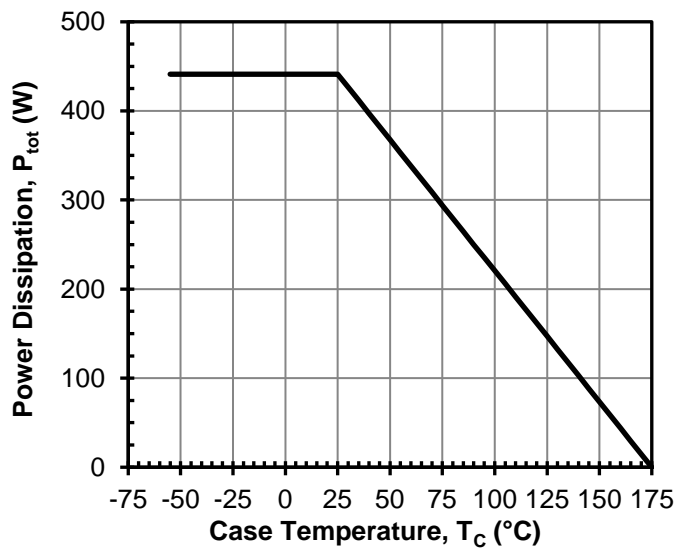


Figure 11 Total power Dissipation

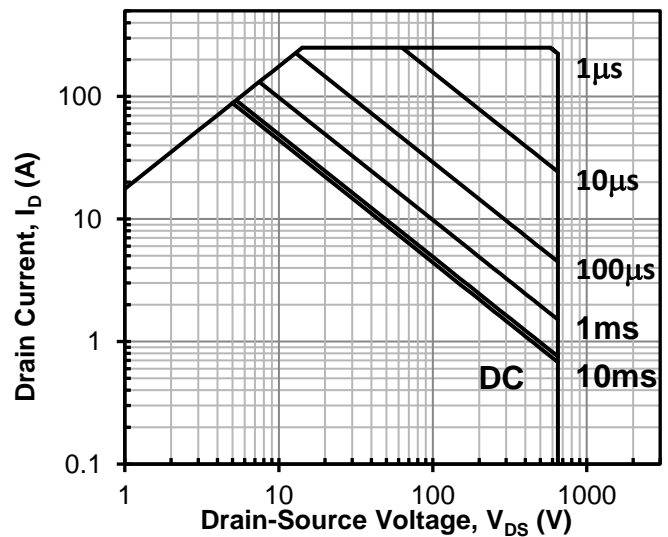


Figure 12 Safe operation area
 $T_c = 25^\circ C$, Parameter t_p

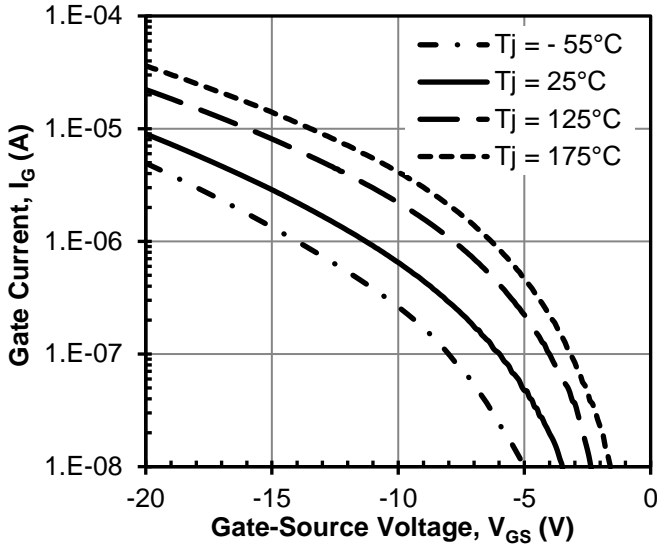


Figure 13 Typical gate leakage current at $V_{DS} = 0V$

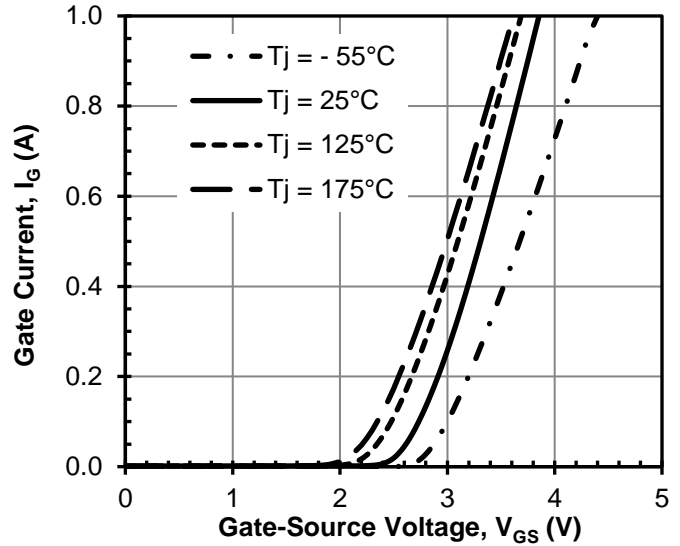


Figure 14 Typical gate forward current at $V_{DS} = 0V$

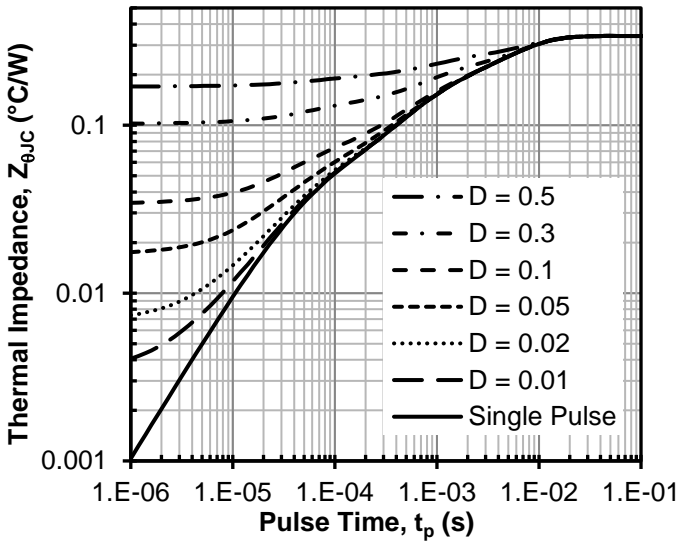


Figure 15 Maximum transient thermal impedance

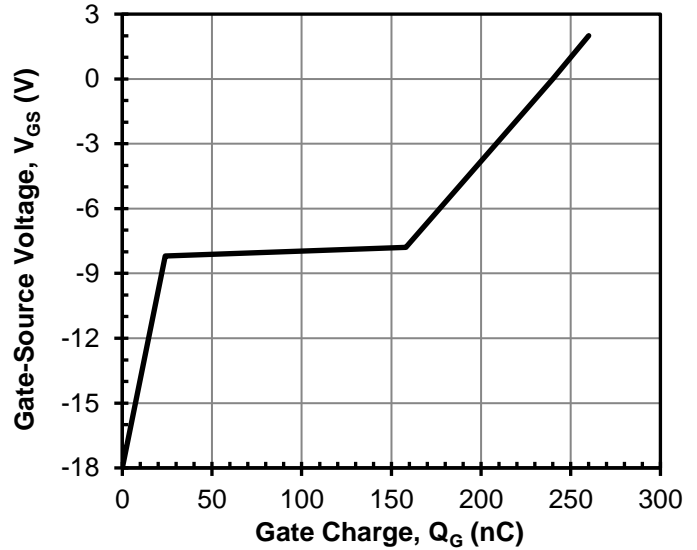


Figure 16 Typical gate charge at $V_{DS} = 400V$ and $I_D = 60A$

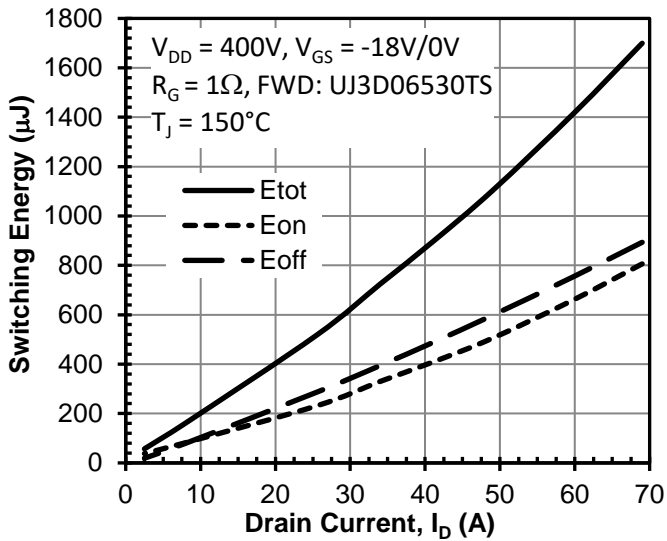


Figure 17 Clamped inductive switching energy vs. drain current at $T_J = 150^\circ\text{C}$

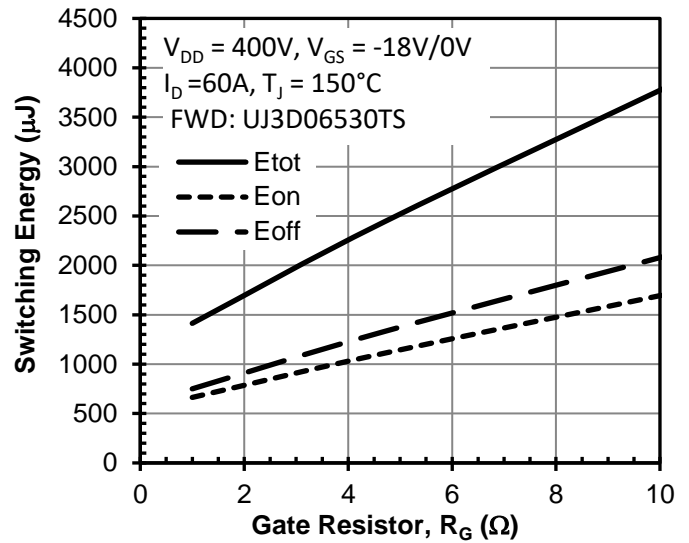


Figure 18 Clamped inductive switching energy vs. gate resistor R_G

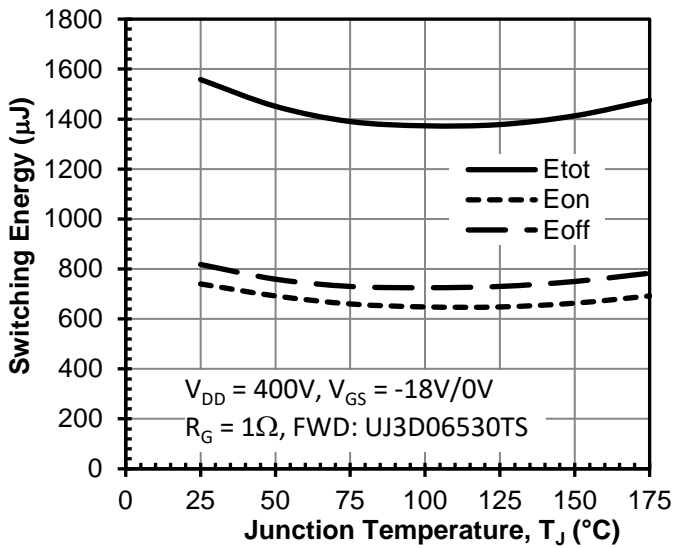


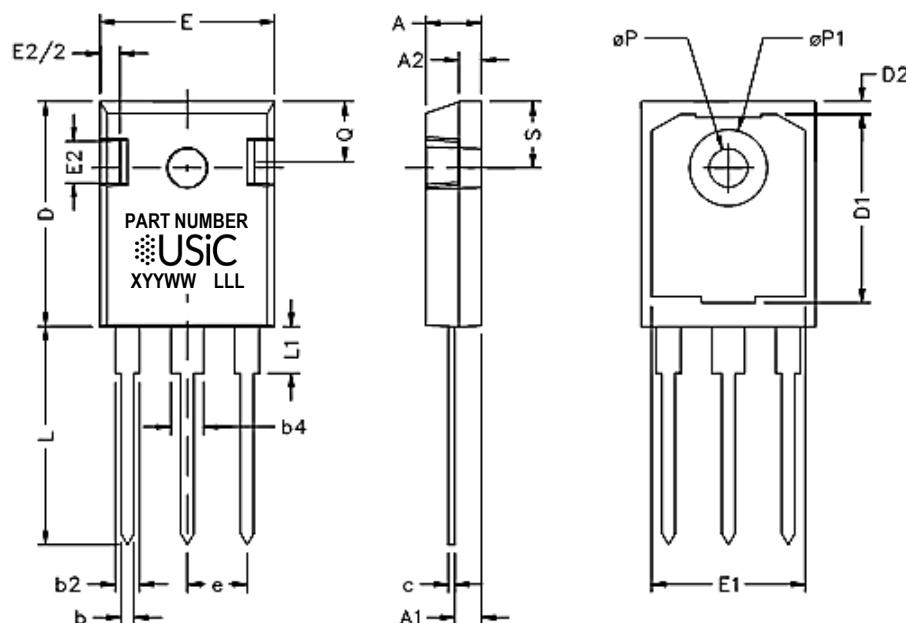
Figure 19 Clamped inductive switching energy vs. junction temperature at $I_D = 60A$

Disclaimer

United Silicon Carbide, Inc. reserves the right to change or modify any of the products and their inherent physical and technical specifications without prior notice. United Silicon Carbide, Inc. assumes no responsibility or liability for any errors or inaccuracies within.

Information on all products and contained herein is intended for description only. No license, express or implied, to any intellectual property rights is granted within this document.

United Silicon Carbide, Inc. assumes no liability whatsoever relating to the choice, selection or use of the United Silicon Carbide, Inc. products and services described herein.

PACKAGE OUTLINE


SYM	INCHES		MILLIMETERS	
	MIN	MAX	MIN	MAX
A	0.185	0.209	4.699	5.309
A1	0.087	0.102	2.21	2.61
A2	0.059	0.098	1.499	2.489
b	0.039	0.055	0.991	1.397
b2	0.065	0.094	1.651	2.388
b4	0.102	0.135	2.591	3.429
c	0.015	0.035	0.381	0.889
D	0.819	0.845	20.803	21.463
D1	0.515	-	13.081	-
D2	0.02	0.053	0.508	1.346
E	0.61	0.64	15.494	16.256
e	0.214 BSC		5.44 BSC	
E1	0.53	-	13.462	-
E2	0.135	0.157	3.429	3.988
L	0.78	0.8	19.812	20.32
L1	-	0.177	-	4.496
øP	0.14	0.144	3.556	3.658
øP1	0.278	0.291	7.061	7.391
Q	0.212	0.244	5.385	6.198
S	0.243 BSC		6.17 BSC	

PART MARKING**PART NUMBER**
XYYWW LLL

PART NUMBER = REFER TO
DS_PN DECODER FOR DETAILS

X = ASSEMBLY SITE

YY = YEAR

WW = WORK WEEK

LLL = LOT ID

PACKING TYPE**ANTI-STATIC TUBE****QUANTITY /TUBE : 30 UNITS****DISCLAIMER**

United Silicon Carbide, Inc. reserves the right to change or modify any of the products and their inherent physical and technical specifications without prior notice. United Silicon Carbide, Inc. assumes no responsibility or liability for any errors or inaccuracies within.

Information on all products and contained herein is intended for description only. No license, express or implied, to any intellectual property rights is granted within this document.

United Silicon Carbide, Inc. assumes no liability whatsoever relating to the choice, selection or use of the United Silicon Carbide, Inc. products and services described herein.

onsemi, **Onsemi**, and other names, marks, and brands are registered and/or common law trademarks of Semiconductor Components Industries, LLC dba "**onsemi**" or its affiliates and/or subsidiaries in the United States and/or other countries. **onsemi** owns the rights to a number of patents, trademarks, copyrights, trade secrets, and other intellectual property. A listing of **onsemi**'s product/patent coverage may be accessed at www.onsemi.com/site/pdf/Patent-Marking.pdf. **onsemi** reserves the right to make changes at any time to any products or information herein, without notice. The information herein is provided "as-is" and **onsemi** makes no warranty, representation or guarantee regarding the accuracy of the information, product features, availability, functionality, or suitability of its products for any particular purpose, nor does **onsemi** assume any liability arising out of the application or use of any product or circuit, and specifically disclaims any and all liability, including without limitation special, consequential or incidental damages. Buyer is responsible for its products and applications using **onsemi** products, including compliance with all laws, regulations and safety requirements or standards, regardless of any support or applications information provided by **onsemi**. "Typical" parameters which may be provided in **onsemi** data sheets and/or specifications can and do vary in different applications and actual performance may vary over time. All operating parameters, including "Typicals" must be validated for each customer application by customer's technical experts. **onsemi** does not convey any license under any of its intellectual property rights nor the rights of others. **onsemi** products are not designed, intended, or authorized for use as a critical component in life support systems or any FDA Class 3 medical devices or medical devices with a same or similar classification in a foreign jurisdiction or any devices intended for implantation in the human body. Should Buyer purchase or use **onsemi** products for any such unintended or unauthorized application, Buyer shall indemnify and hold **onsemi** and its officers, employees, subsidiaries, affiliates, and distributors harmless against all claims, costs, damages, and expenses, and reasonable attorney fees arising out of, directly or indirectly, any claim of personal injury or death associated with such unintended or unauthorized use, even if such claim alleges that **onsemi** was negligent regarding the design or manufacture of the part. **onsemi** is an Equal Opportunity/Affirmative Action Employer. This literature is subject to all applicable copyright laws and is not for resale in any manner.

ADDITIONAL INFORMATION

TECHNICAL PUBLICATIONS:

Technical Library: www.onsemi.com/design/resources/technical-documentation
onsemi Website: www.onsemi.com

ONLINE SUPPORT: www.onsemi.com/support

For additional information, please contact your local Sales Representative at www.onsemi.com/support/sales