



Is Now Part of



**ON Semiconductor®**

To learn more about ON Semiconductor, please visit our website at  
[www.onsemi.com](http://www.onsemi.com)

Please note: As part of the Fairchild Semiconductor integration, some of the Fairchild orderable part numbers will need to change in order to meet ON Semiconductor's system requirements. Since the ON Semiconductor product management systems do not have the ability to manage part nomenclature that utilizes an underscore (\_), the underscore (\_) in the Fairchild part numbers will be changed to a dash (-). This document may contain device numbers with an underscore (\_). Please check the ON Semiconductor website to verify the updated device numbers. The most current and up-to-date ordering information can be found at [www.onsemi.com](http://www.onsemi.com). Please email any questions regarding the system integration to [Fairchild\\_questions@onsemi.com](mailto:Fairchild_questions@onsemi.com).

---

ON Semiconductor and the ON Semiconductor logo are trademarks of Semiconductor Components Industries, LLC dba ON Semiconductor or its subsidiaries in the United States and/or other countries. ON Semiconductor owns the rights to a number of patents, trademarks, copyrights, trade secrets, and other intellectual property. A listing of ON Semiconductor's product/patent coverage may be accessed at [www.onsemi.com/site/pdf/Patent-Marking.pdf](http://www.onsemi.com/site/pdf/Patent-Marking.pdf). ON Semiconductor reserves the right to make changes without further notice to any products herein. ON Semiconductor makes no warranty, representation or guarantee regarding the suitability of its products for any particular purpose, nor does ON Semiconductor assume any liability arising out of the application or use of any product or circuit, and specifically disclaims any and all liability, including without limitation special, consequential or incidental damages. Buyer is responsible for its products and applications using ON Semiconductor products, including compliance with all laws, regulations and safety requirements or standards, regardless of any support or applications information provided by ON Semiconductor. "Typical" parameters which may be provided in ON Semiconductor data sheets and/or specifications can and do vary in different applications and actual performance may vary over time. All operating parameters, including "Typicals" must be validated for each customer application by customer's technical experts. ON Semiconductor does not convey any license under its patent rights nor the rights of others. ON Semiconductor products are not designed, intended, or authorized for use as a critical component in life support systems or any FDA Class 3 medical devices or medical devices with a same or similar classification in a foreign jurisdiction or any devices intended for implantation in the human body. Should Buyer purchase or use ON Semiconductor products for any such unintended or unauthorized application, Buyer shall indemnify and hold ON Semiconductor and its officers, employees, subsidiaries, affiliates, and distributors harmless against all claims, costs, damages, and expenses, and reasonable attorney fees arising out of, directly or indirectly, any claim of personal injury or death associated with such unintended or unauthorized use, even if such claim alleges that ON Semiconductor was negligent regarding the design or manufacture of the part. ON Semiconductor is an Equal Opportunity/Affirmative Action Employer. This literature is subject to all applicable copyright laws and is not for resale in any manner.



# FDMS8570S

## N-Channel PowerTrench<sup>®</sup> SyncFET<sup>™</sup>

25 V, 60 A, 2.8 mΩ

### Features

- Max  $r_{DS(on)}$  = 2.8 mΩ at  $V_{GS} = 10$  V,  $I_D = 24$  A
- Max  $r_{DS(on)}$  = 3.1 mΩ at  $V_{GS} = 4.5$  V,  $I_D = 22$  A
- High performance technology for extremely low  $r_{DS(on)}$
- SyncFET<sup>™</sup> Schottky Body Diode
- RoHS Compliant

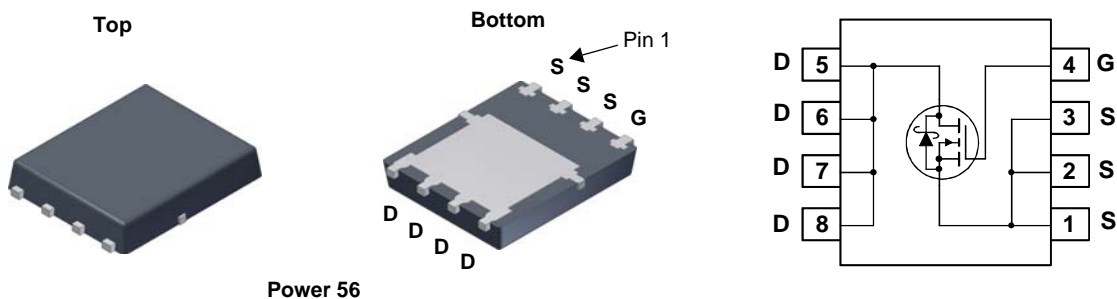


### General Description

This N-Channel SyncFET<sup>™</sup> is produced using Fairchild Semiconductor's advanced PowerTrench<sup>®</sup> process. Advancements in both silicon and package technologies have been combined to offer the lowest  $r_{DS(on)}$  while maintaining excellent switching performance by extremely low Junction-to-Ambient thermal resistance. This device has the added benefit of an efficient monolithic Schottky body diode.

### Applications

- Synchronous Rectifier for DC/DC Converters
- Telecom Secondary Side Rectification
- High End Server/Workstation Vcore Low Side



### MOSFET Maximum Ratings $T_A = 25^\circ\text{C}$ unless otherwise noted

Symbol	Parameter	Rated	Units
$V_{DS}$	Drain to Source Voltage	25	V
$V_{GS}$	Gate to Source Voltage	12	V
$I_D$	Drain Current -Continuous (Package limited) $T_C = 25^\circ\text{C}$	60	A
	-Continuous $T_A = 25^\circ\text{C}$ (Note 1a)	24	
	-Pulsed	100	
$E_{AS}$	Single Pulse Avalanche Energy (Note 3)	45	mJ
$P_D$	Power Dissipation $T_C = 25^\circ\text{C}$	48	W
	Power Dissipation $T_A = 25^\circ\text{C}$ (Note 1a)	2.5	
$T_J, T_{STG}$	Operating and Storage Junction Temperature Range	-55 to +150	$^\circ\text{C}$

### Thermal Characteristics

$R_{\theta JC}$	Thermal Resistance, Junction to Case $T_C = 25^\circ\text{C}$	2.6	$^\circ\text{C/W}$
$R_{\theta JA}$	Thermal Resistance, Junction to Ambient (Note 1a)	50	

### Package Marking and Ordering Information

Device Marking	Device	Package	Reel Size	Tape Width	Quantity
100D	FDMS8570S	Power 56	13"	12 mm	3000 units

## Electrical Characteristics $T_J = 25\text{ }^\circ\text{C}$ unless otherwise noted

Symbol	Parameter	Test Conditions	Min	Typ	Max	Units
--------	-----------	-----------------	-----	-----	-----	-------

### Off Characteristics

$BV_{DSS}$	Drain to Source Breakdown Voltage	$I_D = 1\text{ mA}, V_{GS} = 0\text{ V}$	25			V
$\frac{\Delta BV_{DSS}}{\Delta T_J}$	Breakdown Voltage Temperature Coefficient	$I_D = 10\text{ mA}$ , referenced to $25\text{ }^\circ\text{C}$		23		mV/°C
$I_{DSS}$	Zero Gate Voltage Drain Current	$V_{DS} = 20\text{ V}, V_{GS} = 0\text{ V}$			500	$\mu\text{A}$
$I_{GSS}$	Gate to Source Leakage Current	$V_{GS} = +12\text{ V}/-8\text{ V}, V_{DS} = 0\text{ V}$			$\pm 100$	nA

### On Characteristics

$V_{GS(th)}$	Gate to Source Threshold Voltage	$V_{GS} = V_{DS}, I_D = 1\text{ mA}$	1.1	1.5	2.2	V
$\frac{\Delta V_{GS(th)}}{\Delta T_J}$	Gate to Source Threshold Voltage Temperature Coefficient	$I_D = 10\text{ mA}$ , referenced to $25\text{ }^\circ\text{C}$		-3		mV/°C
$r_{DS(on)}$	Static Drain to Source On Resistance	$V_{GS} = 10\text{ V}, I_D = 24\text{ A}$		2.1	2.8	m $\Omega$
		$V_{GS} = 4.5\text{ V}, I_D = 22\text{ A}$		2.4	3.1	
		$V_{GS} = 10\text{ V}, I_D = 24\text{ A}, T_J = 125\text{ }^\circ\text{C}$		2.9	3.9	
$g_{FS}$	Forward Transconductance	$V_{DS} = 5\text{ V}, I_D = 24\text{ A}$		215		S

### Dynamic Characteristics

$C_{iss}$	Input Capacitance	$V_{DS} = 13\text{ V}, V_{GS} = 0\text{ V},$ $f = 1\text{ MHz}$		2825		pF
$C_{oss}$	Output Capacitance			662		pF
$C_{rss}$	Reverse Transfer Capacitance			94		pF
$R_g$	Gate Resistance			0.8		$\Omega$

### Switching Characteristics

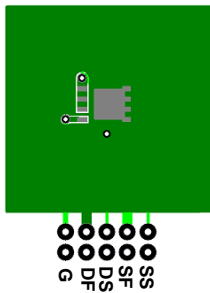
$t_{d(on)}$	Turn-On Delay Time	$V_{DD} = 13\text{ V}, I_D = 24\text{ A},$ $V_{GS} = 10\text{ V}, R_{GEN} = 6\text{ }\Omega$		11		ns	
$t_r$	Rise Time			4		ns	
$t_{d(off)}$	Turn-Off Delay Time			33		ns	
$t_f$	Fall Time			3		ns	
$Q_g$	Total Gate Charge		$V_{GS} = 0\text{ V to } 10\text{ V}$		42		nC
$Q_g$	Total Gate Charge		$V_{GS} = 0\text{ V to } 4.5\text{ V}$	$V_{DD} = 13\text{ V},$ $I_D = 24\text{ A}$	22		nC
$Q_{gs}$	Gate to Source Gate Charge			6.4		nC	
$Q_{gd}$	Gate to Drain "Miller" Charge			4.4		nC	

### Drain-Source Diode Characteristics

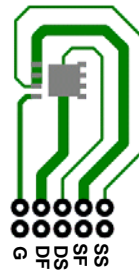
$V_{SD}$	Source to Drain Diode Forward Voltage	$V_{GS} = 0\text{ V}, I_S = 2\text{ A}$ (Note 2)		0.6	0.8	V
		$V_{GS} = 0\text{ V}, I_S = 24\text{ A}$ (Note 2)		0.8	1.2	
$t_{rr}$	Reverse Recovery Time	$I_F = 24\text{ A}, di/dt = 300\text{ A}/\mu\text{s}$		22		ns
$Q_{rr}$	Reverse Recovery Charge			19		nC

#### NOTES:

- $R_{\theta JA}$  is determined with the device mounted on a FR-4 board using a specified pad of 2 oz copper as shown below.  $R_{\theta JC}$  is guaranteed by design while  $R_{\theta CA}$  is determined by the user's board design.



a)  $50\text{ }^\circ\text{C/W}$  when mounted on a  $1\text{ in}^2$  pad of 2 oz copper



b)  $125\text{ }^\circ\text{C/W}$  when mounted on a minimum pad of 2 oz copper.

2. Pulse Test: Pulse Width < 300  $\mu\text{s}$ , Duty cycle < 2.0%.

3.  $E_{AS}$  of 45 mJ is based on starting  $T_J = 25\text{ }^\circ\text{C}$ ,  $L = 0.4\text{ mH}$ ,  $I_{AS} = 15\text{ A}$ ,  $V_{DD} = 23\text{ V}$ ,  $V_{GS} = 10\text{ V}$ . 100% test at  $L = 0.1\text{ mH}$ ,  $I_{AS} = 23.8\text{ A}$ .

**Typical Characteristics**  $T_J = 25\text{ }^\circ\text{C}$  unless otherwise noted

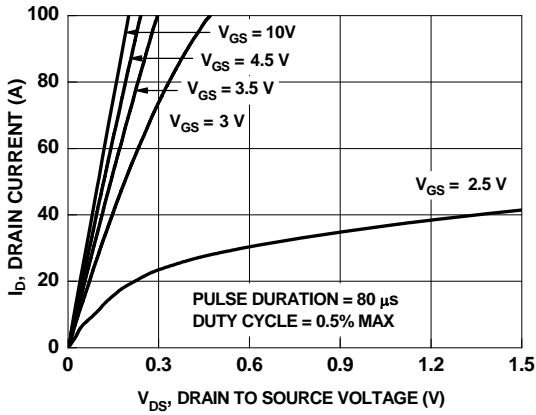


Figure 1. On Region Characteristics

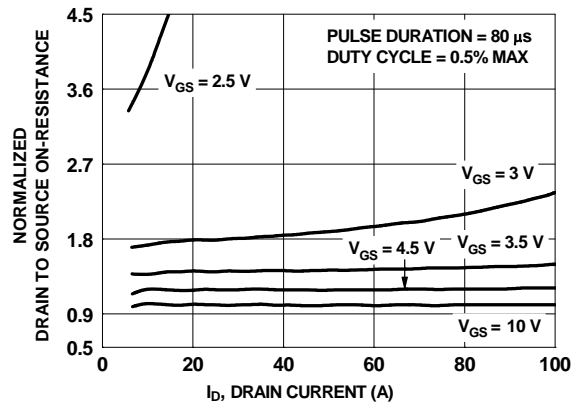


Figure 2. Normalized On-Resistance vs Drain Current and Gate Voltage

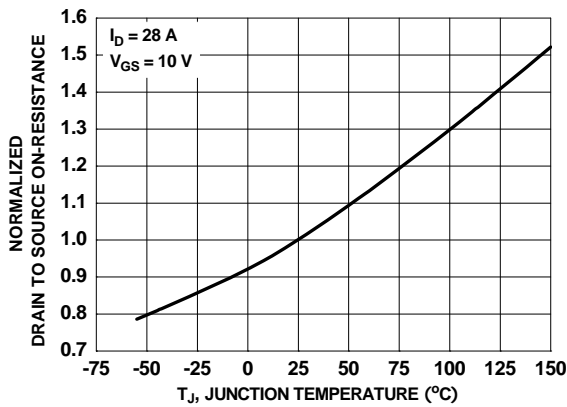


Figure 3. Normalized On Resistance vs Junction Temperature

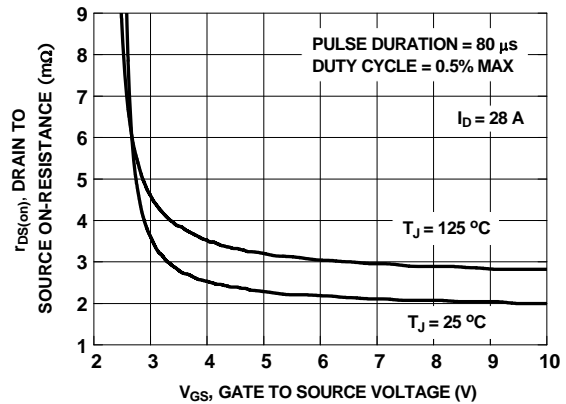


Figure 4. On-Resistance vs Gate to Source Voltage

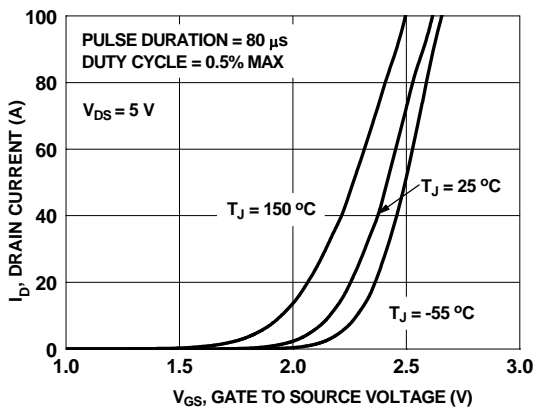


Figure 5. Transfer Characteristics

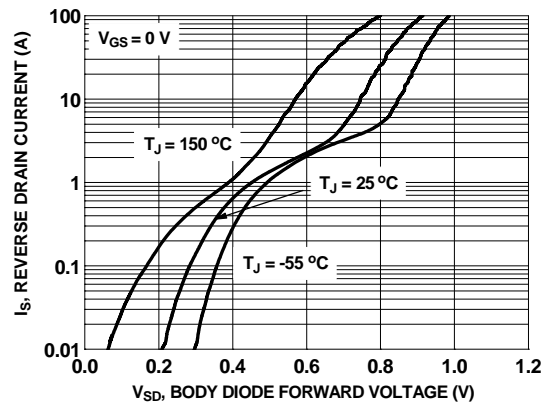
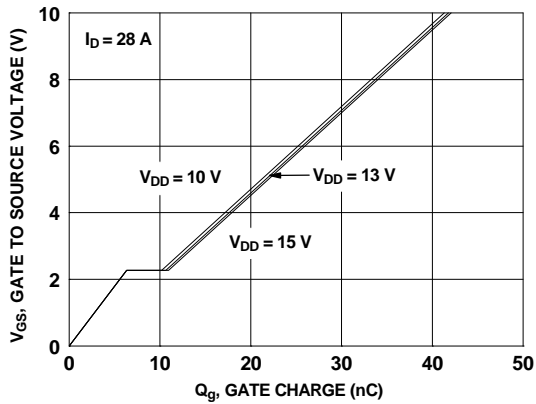
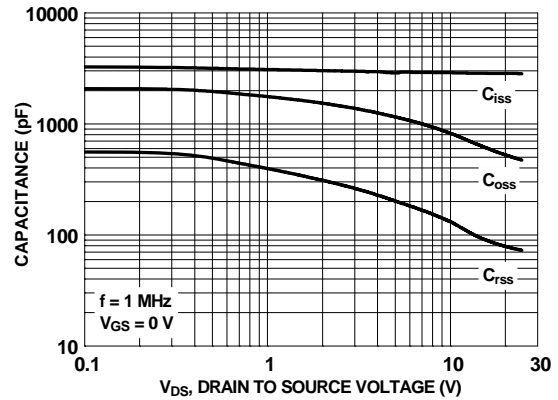


Figure 6. Source to Drain Diode Forward Voltage vs Source Current

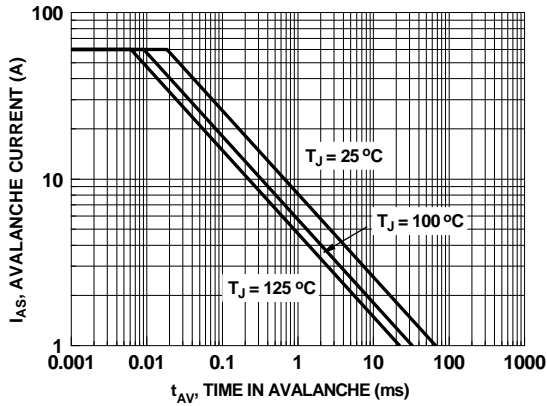
**Typical Characteristics**  $T_J = 25\text{ }^\circ\text{C}$  unless otherwise noted



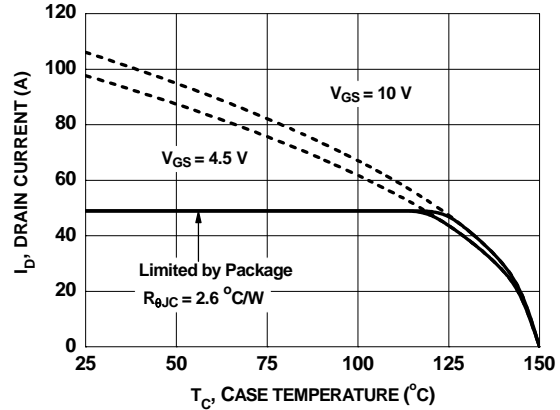
**Figure 7. Gate Charge Characteristics**



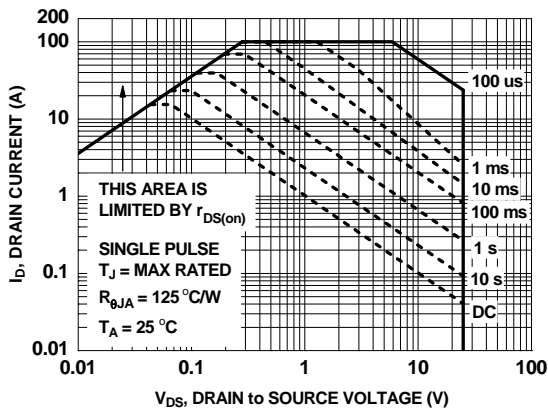
**Figure 8. Capacitance vs Drain to Source Voltage**



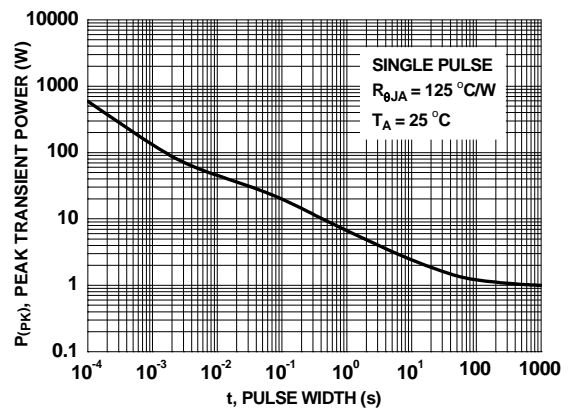
**Figure 9. Unclamped Inductive Switching Capability**



**Figure 10. Maximum Continuous Drain Current vs Ambient Temperature**

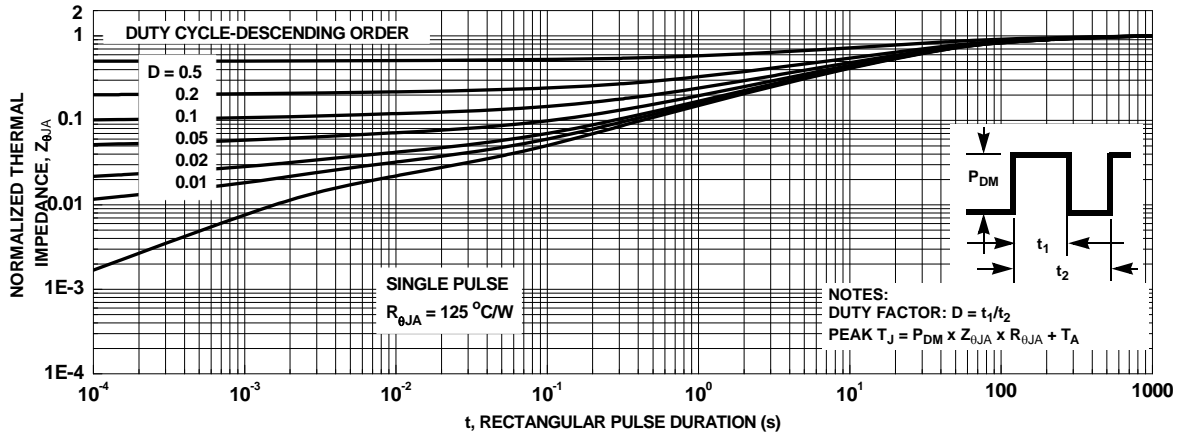


**Figure 11. Forward Bias Safe Operating Area**



**Figure 12. Single Pulse Maximum Power Dissipation**

**Typical Characteristics**  $T_J = 25\text{ }^\circ\text{C}$  unless otherwise noted



**Figure 13. Junction-to-Ambient Transient Thermal Response Curve**

## Typical Characteristics (continued)

### SyncFET<sup>™</sup> Schottky body diode Characteristics

Fairchild's SyncFET<sup>™</sup> process embeds a Schottky diode in parallel with PowerTrench MOSFET. This diode exhibits similar characteristics to a discrete external Schottky diode in parallel with a MOSFET. Figure 14 shows the reverse recovery characteristic of the FDMS8570S.

Schottky barrier diodes exhibit significant leakage at high temperature and high reverse voltage. This will increase the power in the device.

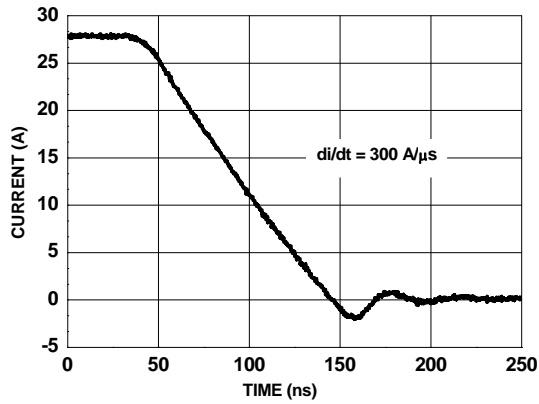


Figure 14. FDMS8570S SyncFET<sup>™</sup> body diode reverse recovery characteristic

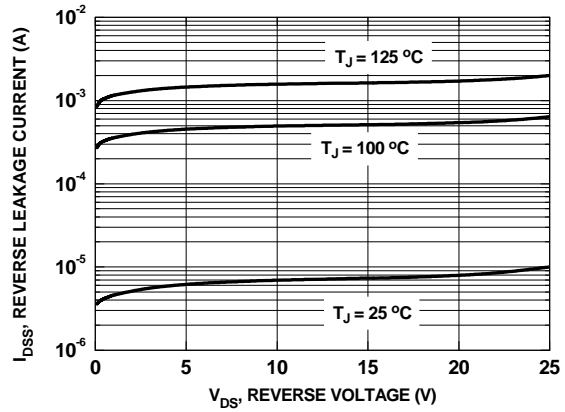
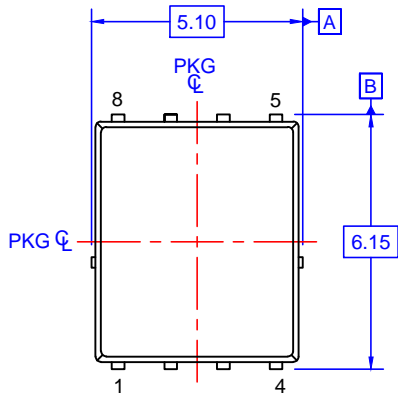
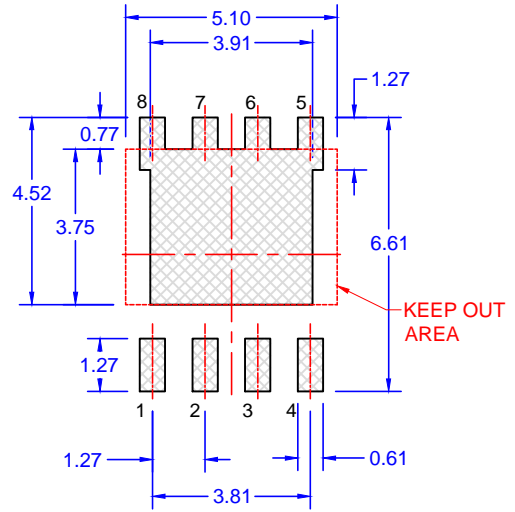
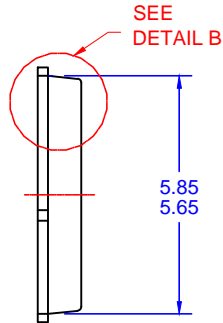


Figure 15. SyncFET<sup>™</sup> body diode reverse leakage versus drain-source voltage

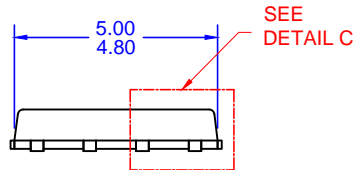
PQFN8 5X6, 1.27P  
CASE 483AE  
ISSUE A



TOP VIEW

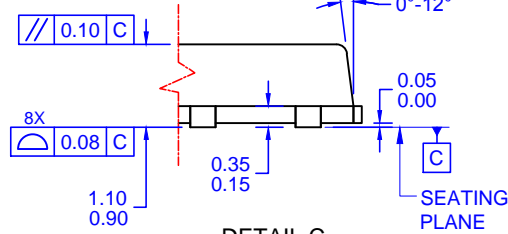


LAND PATTERN RECOMMENDATION

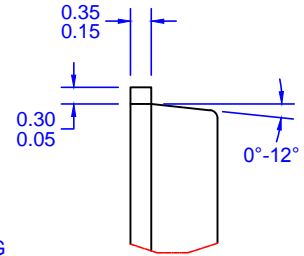


SIDE VIEW

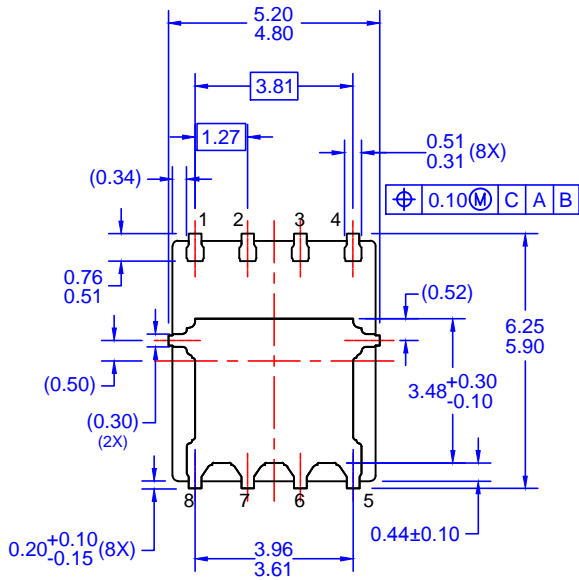
OPTIONAL DRAFT ANGLE MAY APPEAR ON FOUR SIDES OF THE PACKAGE



DETAIL C  
SCALE: 2:1



DETAIL B  
SCALE: 2:1



BOTTOM VIEW

NOTES: UNLESS OTHERWISE SPECIFIED

- A. PACKAGE STANDARD REFERENCE: JEDEC MO-240, ISSUE A, VAR. AA.
- B. DIMENSIONS DO NOT INCLUDE BURRS OR MOLD FLASH. MOLD FLASH OR BURRS DOES NOT EXCEED 0.10MM.
- C. ALL DIMENSIONS ARE IN MILLIMETERS.
- D. DIMENSIONING AND TOLERANCING PER ASME Y14.5M-2009.
- E. IT IS RECOMMENDED TO HAVE NO TRACES OR VIAS WITHIN THE KEEP OUT AREA.





ON Semiconductor and  are trademarks of Semiconductor Components Industries, LLC dba ON Semiconductor or its subsidiaries in the United States and/or other countries. ON Semiconductor owns the rights to a number of patents, trademarks, copyrights, trade secrets, and other intellectual property. A listing of ON Semiconductor's product/patent coverage may be accessed at [www.onsemi.com/site/pdf/Patent-Marking.pdf](http://www.onsemi.com/site/pdf/Patent-Marking.pdf). ON Semiconductor reserves the right to make changes without further notice to any products herein. ON Semiconductor makes no warranty, representation or guarantee regarding the suitability of its products for any particular purpose, nor does ON Semiconductor assume any liability arising out of the application or use of any product or circuit, and specifically disclaims any and all liability, including without limitation special, consequential or incidental damages. Buyer is responsible for its products and applications using ON Semiconductor products, including compliance with all laws, regulations and safety requirements or standards, regardless of any support or applications information provided by ON Semiconductor. "Typical" parameters which may be provided in ON Semiconductor data sheets and/or specifications can and do vary in different applications and actual performance may vary over time. All operating parameters, including "Typicals" must be validated for each customer application by customer's technical experts. ON Semiconductor does not convey any license under its patent rights nor the rights of others. ON Semiconductor products are not designed, intended, or authorized for use as a critical component in life support systems or any FDA Class 3 medical devices or medical devices with a same or similar classification in a foreign jurisdiction or any devices intended for implantation in the human body. Should Buyer purchase or use ON Semiconductor products for any such unintended or unauthorized application, Buyer shall indemnify and hold ON Semiconductor and its officers, employees, subsidiaries, affiliates, and distributors harmless against all claims, costs, damages, and expenses, and reasonable attorney fees arising out of, directly or indirectly, any claim of personal injury or death associated with such unintended or unauthorized use, even if such claim alleges that ON Semiconductor was negligent regarding the design or manufacture of the part. ON Semiconductor is an Equal Opportunity/Affirmative Action Employer. This literature is subject to all applicable copyright laws and is not for resale in any manner.

## PUBLICATION ORDERING INFORMATION

### LITERATURE FULFILLMENT:

Literature Distribution Center for ON Semiconductor  
19521 E. 32nd Pkwy, Aurora, Colorado 80011 USA  
**Phone:** 303-675-2175 or 800-344-3860 Toll Free USA/Canada  
**Fax:** 303-675-2176 or 800-344-3867 Toll Free USA/Canada  
**Email:** [orderlit@onsemi.com](mailto:orderlit@onsemi.com)

**N. American Technical Support:** 800-282-9855 Toll Free  
USA/Canada  
**Europe, Middle East and Africa Technical Support:**  
Phone: 421 33 790 2910  
**Japan Customer Focus Center**  
Phone: 81-3-5817-1050

**ON Semiconductor Website:** [www.onsemi.com](http://www.onsemi.com)  
**Order Literature:** <http://www.onsemi.com/orderlit>  
For additional information, please contact your local  
Sales Representative