

# ON Semiconductor

## Is Now

# onsemi™

To learn more about onsemi™, please visit our website at  
[www.onsemi.com](http://www.onsemi.com)

---

**onsemi** and **onsemi** and other names, marks, and brands are registered and/or common law trademarks of Semiconductor Components Industries, LLC dba "**onsemi**" or its affiliates and/or subsidiaries in the United States and/or other countries. **onsemi** owns the rights to a number of patents, trademarks, copyrights, trade secrets, and other intellectual property. A listing of **onsemi** product/patent coverage may be accessed at [www.onsemi.com/site/pdf/Patent-Marking.pdf](http://www.onsemi.com/site/pdf/Patent-Marking.pdf). **onsemi** reserves the right to make changes at any time to any products or information herein, without notice. The information herein is provided "as-is" and **onsemi** makes no warranty, representation or guarantee regarding the accuracy of the information, product features, availability, functionality, or suitability of its products for any particular purpose, nor does **onsemi** assume any liability arising out of the application or use of any product or circuit, and specifically disclaims any and all liability, including without limitation special, consequential or incidental damages. Buyer is responsible for its products and applications using **onsemi** products, including compliance with all laws, regulations and safety requirements or standards, regardless of any support or applications information provided by **onsemi**. "Typical" parameters which may be provided in **onsemi** data sheets and/or specifications can and do vary in different applications and actual performance may vary over time. All operating parameters, including "Typicals" must be validated for each customer application by customer's technical experts. **onsemi** does not convey any license under any of its intellectual property rights nor the rights of others. **onsemi** products are not designed, intended, or authorized for use as a critical component in life support systems or any FDA Class 3 medical devices or medical devices with a same or similar classification in a foreign jurisdiction or any devices intended for implantation in the human body. Should Buyer purchase or use **onsemi** products for any such unintended or unauthorized application, Buyer shall indemnify and hold **onsemi** and its officers, employees, subsidiaries, affiliates, and distributors harmless against all claims, costs, damages, and expenses, and reasonable attorney fees arising out of, directly or indirectly, any claim of personal injury or death associated with such unintended or unauthorized use, even if such claim alleges that **onsemi** was negligent regarding the design or manufacture of the part. **onsemi** is an Equal Opportunity/Affirmative Action Employer. This literature is subject to all applicable copyright laws and is not for resale in any manner. Other names and brands may be claimed as the property of others.

# AND8019/D

## Offline Converter Provides 5.0 Volt, 1.0 Amp Output for Small Electronic Equipment

Prepared by: Alan Ball  
ON Semiconductor



ON Semiconductor®

<http://onsemi.com>

### APPLICATION NOTE

#### General Description

ON Semiconductor's NCP1000 series of offline converters offers a low cost, high efficiency power source for low power, electronic equipment. It serves the same function as small, line frequency transformers, but with the added benefits of line and load regulation, transient suppression, reduction in weight, and operation across the universal input voltage range.

This kit provides a 5.0 volt, 1.0 amp output, which is derived from an input source of 85 to 265 VAC, and 50 Hz to 60 Hz. This range of input voltages will allow this circuit to function virtually anywhere in the world without modification. The output is regulated and current limited. Both common mode and differential mode EMI filtering are incorporated on the ac line.

#### Features

- Output Well Regulated Over Changes in Line and Load
- Minimal Parts Count
- Universal Input Voltage Range
- 100 kHz Switching Frequency
- Power Switch and Current Sense Built into Chip
- No External Startup Circuit Required
- Thermal Shutdown Circuitry Included
- Board Designed for EMI and UL Approvals

#### Parts List

Description / Manufacturer	Part Number	Reference
Cap, x-series, .082 $\mu$ F, 250 Vac Panasonic	ECQ-U2A823MV	C1
Cap, Alum elect, 10 $\mu$ F, 450 V Panasonic	EEU-EB2W100	C2, C3
Cap, ceramic, 2.2 pF, 1000 Vac Panasonic	ECK-D3A222KBP	C4
Cap, Alum elect, 3.3 $\mu$ F, 25 V Panasonic	ECE-A1EKK3R3	C5

Cap, ceramic, 1.0 $\mu$ F, 10 V, 0603 TDK	C1608X5R1A105K	C6
Cap, ceramic, .01 $\mu$ F, 50 V, 0603 TDK	C1608X7R1A103K	C7, C11
Cap, Alum elect, 10 $\mu$ F, 25 V Panasonic	ECA-1EM100	C8
Cap, Alum elect, 1500 $\mu$ F, 6.3 V Panasonic	EEU-FCOJ152	C9, C10
Cap, class X1, 1.0 nF, 440 Vac Vishay/Roederstein	WYO102MCMBFOK	C12
Diode, Rectifier, 600 V, 1.0 A ON Semiconductor	1N4005	D1-D4
Rectifier, Schottky, 40 V, 3.0 A ON Semiconductor	MBRS340T3	D5
Diode, Switching, 70 V, 200 mA ON Semiconductor	MMBD6050LT1	D6
Diode, Ultra-Fast 600 V, 1.0 A, ON Semiconductor	MUR160	D7
Fuse, 160 mA, 250 Vac Cooper Bussman	BK/ETF-160MA	F1
Inductor, 33 $\mu$ H Cooper Coiltronics	UP0.4C-330	L1
Connector Beau	830502	P1, P2
Resistor, 470 $\Omega$ , 5% Vishay/Dale	CRCW1206-471-5%	R1
Resistor, 4.7 k $\Omega$ , .25 W, 5%	-	R2
Resistor, 270 $\Omega$ , 5% Vishay/Dale	CRCW1206-271-5%	R3
Resistor, 2.0 k $\Omega$ , 5% Vishay/Dale	CRCW1206-2k1%	R4, R5
Resistor, 6.8 $\Omega$ , .25 W, 5%	-	R6, R7
Resistor, 10 $\Omega$ , .25 W, 5%	-	R8, R9
Transformer, flyback Cooper Coiltronics	CTX13-14602	T1
IC, Switching Regulator ON Semiconductor	NCP1000P	U1
Optocoupler Lumex	67-1560-5	U2
IC, Voltage Regulator ON Semiconductor	TL431AID	U3

**Manufacturers Contact Data**

Mfr.	Phone	Web
ON Semiconductor	800 282-9855	www.onsemi.com
Cooper Electronics	561 752-5000	www.cooperet.com
TDK	847 803-6100	www.component.tdk.com
Mallory	317 273-0090	www.nacc-doesit.com
Vishay/...	818 781-1642	www.vishay.com/index.html
Lumex	847 359-2790	www.lumex.com
Beau Interconnect	603 524-5101	www.beauint.com
Panasonic	-	www.panasonic.com

**Board Evaluation**

The following Power Supply Test Setup diagram and description is designed to allow the board to be tested for all parameters listed in the Converter Test Data table. This may be used to confirm proper operation of the board, as well as operating parameters of modified boards.

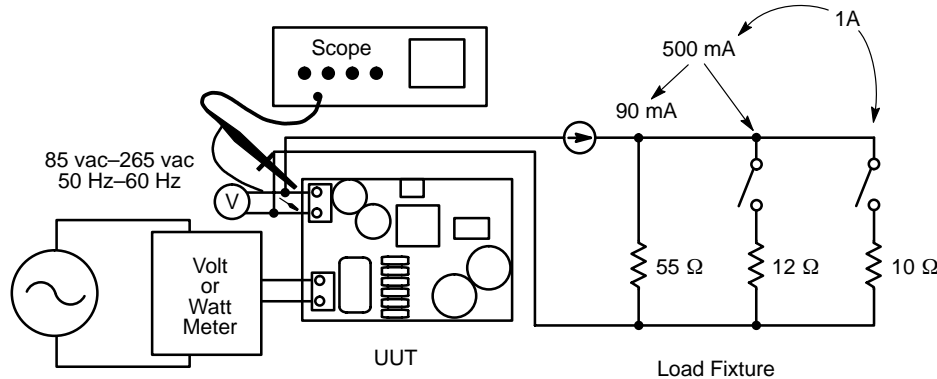

**Figure 1. Power Supply Test Setup**

**Test Setup**

The input power source needs to be variable over the range of voltages and frequencies that you choose to test. This can be either a variac or an electronic power source.

Connect it to a voltmeter or wattmeter. A wattmeter will be required to measure efficiency. If none is available, use a voltmeter. The output of the meter will be fed into the input connector on the board. The polarity is not important as this converter has an isolated output. Please keep in mind that the input side of this circuit is hot – including the ground.

The output connector should be connected to an ammeter in the high line, and then to a set of load resistors. The 12 Ω and 10 Ω resistors should be rated at 10 watts, and the 55 Ω at 2.0 watts.

Any lab scope with at least a 20 MHz bandwidth will be adequate to observe ripple and switching waveforms.

The unit will not be damaged by input voltages below 85 volts, but may not operate properly. Do not exceed the 265 volt rating as this could damage the NCP1000 as well as other components.

**Measurement Techniques**

To accurately measure the output voltage and ripple, the voltmeter and oscilloscope probes should be connected as close as possible to the output terminals of the board. Measuring the output voltage at the load resistors will result in errors due to the impedance of the ammeter and of the lead wires.

Ripple measurements often contain large amounts of common mode noise. Before taking measurements, connect the scope probe to the ground lead at the negative output terminal. Any spikes that are on the screen of the scope are common mode noise that is being picked up by the scope leads, and are not part of the output ripple. This phenomenon may be reduced by using two scope probes in a differential measurement mode.

Connect both ground leads to the negative output terminal. Connect one scope probe to the negative terminal also, and the other to the positive terminal. Set the scope up to subtract the ground signal from the ripple signal, and the resulting waveform will be a more accurate representation of the ripple.

**Regulation**

To measure line regulation, hold the load constant and vary the input over the desired range taking measurements at convenient intervals. The change in output voltage for a fixed load, across the range of input voltages is the line regulation.

Load regulation is measured in a similar manner. The line is held constant and the output voltage is measured as the load is varied from minimum to maximum.

**Ripple**

The scope should be connected as described in the Measurement Techniques section, and should be ac coupled. Peak-to-peak ripple is the measurement from the lowest point to the highest point on the trace. If a peak-to-mean measurement is desired, set the scope input to ground, move the trace on top of the center graticule line of the scope, and then set the scope coupling back to ac. The voltage from the lowest point on the trace and the highest point on the trace, to the center graticule line are the peak-to-mean measurements.

**Efficiency**

Efficiency is defined as:

$$\eta = P_{out}/P_{in} = (V_o \times I_o) / P_{in}$$

The output power is the output voltage multiplied by the output current. The input power must be read from a quality wattmeter with a wide bandwidth due to the harmonic content of the input current waveform. There is no accurate method of measuring the input power by the use of DVM's or oscilloscopes.

Most wattmeters will also measure power factor, line voltage and line current.

**Transient Loads**

Rapid changes in the load of a power converter cause the output voltage to increase or decrease for a short period of time. If the circuit that will be attached to this converter is sensitive to small excursions in voltage, it is highly recommended to test the unit under similar transients. The following exercise will test the unit for a transient from 250 mA to 1.0 A and from 1.0 A to 250 mA. If the actual load transient is different, the loads should be modified to reflect those conditions.

Response to load transients can be observed by causing a step load change and synching the oscilloscope to this event. The best way to do this is to replace the switch on the 500 mA load (10 Ω resistor) with a FET. An ON Semiconductor MTD3302 transistor, driven by a pulse generator with a 0 volt to 10 volt pulse will make a simple electronic switch. Figures 8 and 9 show the transient response to an output load change of 10% to 100% load.

Observing the output voltage on an oscilloscope during this event will allow measurement of the level of perturbation as well as the duration.

**Converter Test Data**

Parameter	Conditions	Data
Line Regulation	85 V ≤ V <sub>in</sub> ≤ 265 V	ΔV <sub>o</sub> = 6.0 mV
Load Regulation	0 A ≤ I <sub>o</sub> ≤ 1.0 A	ΔV <sub>o</sub> = 8.0 mV
Combined Line/ Load Regulation	85 V ≤ V <sub>in</sub> ≤ 265 V 0 A ≤ I <sub>o</sub> ≤ 1.0 A	ΔV <sub>o</sub> = 10 mV
Output Ripple	I <sub>o</sub> = 1.0 A	100 mV <sub>pp</sub>
Input Power	V <sub>in</sub> = 115 V, I <sub>o</sub> = 1.0 A V <sub>in</sub> = 220 V, I <sub>o</sub> = 1.0 A	7.75 watts 7.88 watts
Power Factor	V <sub>in</sub> = 115 V, I <sub>o</sub> = 1.0 A V <sub>in</sub> = 220 V, I <sub>o</sub> = 1.0 A	-0.57 -0.49
Efficiency	V <sub>in</sub> = 115 V, I <sub>o</sub> = 1.0 A V <sub>in</sub> = 220 V, I <sub>o</sub> = 1.0 A	η = 66% η = 64%

**Troubleshooting**

Symptom	Solution
Unit does not turn on, does not draw current	<ol style="list-style-type: none"> <li>1. Assure that ac source and meter are properly connected by measuring the voltage at the input connector.</li> <li>2. Measure the voltage across C2. If it is not approximately equal to the peak input voltage, check for wrong or defective components (R6, R7, D1–D4).</li> <li>3. Observe voltage at pin 1 of U1. This voltage needs to exceed 8.5 volts for unit to start, and remain greater than 7.5 volts for unit to operate. If not in this range check for shorts, and assure that pin 5 is greater than 50 volts, otherwise replace chip.</li> <li>4. Measure the voltage at pin 2 of U1. It should measure less than 4.5 volts for PWM to be active. If it is, and the output is not switching, the NCP1000 may be defective.</li> </ol>
Unit does not turn on, draws excessive current	<ol style="list-style-type: none"> <li>1. Check for obvious shorts on the board and remove if found.</li> <li>2. Disconnect all leads and measure resistance across C2. If no short is found, check test setup. If a short is found, isolate it by removing components and testing (D1–D4, C2, U1).</li> </ol>
<ul style="list-style-type: none"> <li>• Unit does not regulate</li> </ul>	<ol style="list-style-type: none"> <li>1. Assure that the input voltage and output current are in the specified ranges.</li> <li>2. Measure voltage across C8. It should be at least twice the output voltage. If not, check D6, L2 and C8.</li> <li>3. Check the voltage at pin 2. If it is greater than 4.5 volts the opto may be shorted, if 0 the opto may open or C4 may be shorted.</li> <li>4. Measure voltage at pin 8 of U3 and measure voltage drop across R3. If: <ul style="list-style-type: none"> <li>• V<sub>8</sub> &lt; 2.5 volts &amp; V<sub>R3</sub> = 0 then replace U2.</li> <li>• V<sub>8</sub> &lt; 2.5 volts &amp; V<sub>R3</sub> &gt; 0 then replace U3.</li> <li>• V<sub>8</sub> &gt; 2.5 volts &amp; V<sub>R3</sub> = 0 then replace U3.</li> <li>• V<sub>8</sub> &gt; 2.5 volts &amp; V<sub>R3</sub> &gt; 0 then replace U2.</li> </ul> </li> </ol>

## Theory of Operation

### Input

The ac source is connected to the input terminals of this unit. Fuse F1 is a safety device for fire protection and not intended to protect the circuit from overcurrent conditions. C1, R6 and R7 comprise the input EMI filter. Diodes D1–D4 rectify the ac line which is then filtered by capacitor, C2.

### Primary Power Circuit

The NCP1000 power switching regulator chip contains the control circuit, startup circuit and power switch circuit.

The startup circuit allows a small amount of current from pin 5 to charge C8 and C5. When this voltage reaches approximately 8.5 volts, the unit will commence operation as can be observed at pin 5. Once the unit begins switching, it's power is derived from the auxiliary winding of the transformer through D6 and C8. Power from C8 is delivered to pin 1.

C5 provides energy storage at pin 1. R1, which is placed in series between the aux winding supply (C8) and pin 1, limits the current into the  $V_{CC}$  pin. The  $V_{CC}$  voltage is supplied by the aux winding and limited by an internal 8.6 volt shunt regulator.

### Primary Regulation Circuit

The NCP1000 receives the error signal via an opto-coupler at pin 2, the Feedback input. This input has an internal 2.7 k $\Omega$  resistor to ground. As current from the opto-coupler flows into pin 2, it develops a voltage across the internal resistor. This voltage is used as the error signal into the PWM comparator to determine the duty cycle. As the voltage on pin 2 increases, the duty cycle will decrease, and therefore, the output power will decrease.

### Secondary Regulation

Regulation is accomplished by comparing the output voltage (voltage divider R4 and R5) to a fixed reference within the TL431 regulator. The TL431 also has an internal amplifier which is used as the error amplifier for this circuit. The output of the TL431 conducts a current that biases the photodiode of U2. This in turn causes the phototransistor of U2 to conduct and provides a voltage to the NCP1000 chip that has the error information required for regulation. C10 is used to compensate the internal error amplifier in the TL431 for frequency stability.

### Current Limit Protection

The NCP1000 includes an internal current limit circuit. The nominal threshold is 0.50 amps peak of switch current. If the current tries to exceed this level, the current limit comparator will terminate the pulse at 0.50 amps. Under current limit conditions, the output voltage will reduce as necessary to maintain a this maximum switch current. Due to the characteristics of a flyback converter, the unit will go into a constant power mode in current limit. This means that as the output voltage is reduced, the output current will increase.

As the output approaches a short circuit condition, the auxiliary winding voltage will reduce along with the output voltage. When the auxiliary winding is reduced below the UVLO shutdown level, the unit will shutdown, and time out for eight  $V_{CC}$  charging cycles, to reduce power dissipation, before restarting. Due to leakage inductance spikes, the auxiliary voltage may not track the output voltage proportionally. If short circuit protection is required, it is recommended that a secondary side current limit circuit be used to assure unit will be completely protected under short circuit conditions.

### Modification of Output Voltage or Current

This circuit has been designed to provide a regulated 5.0 volt output at a maximum current of 1.0 amp. Changes will require redesign in several areas of the circuit.

The output voltage is determined by comparing the output of the voltage divider of R4 and R5 to the 2.5 volt internal reference in the TL431. This resistive divider must be modified to change the output voltage. To do this, first choose the bias current that you want in the divider –1.0 mA is a good rule of thumb. The voltage across R5 will always be 2.5 volts, so the equation for R5 is:

$$R5 \text{ (k}\Omega\text{)} = 2.5 \text{ volts} / I_{\text{bias}} \text{ (mA)}$$

and

$$R4 = R5 \times (V_o - 2.5 \text{ volts}) / 2.5 \text{ V}$$

Since it is necessary to maintain a voltage of at least 9.5 volts on C8 at all times, the auxiliary winding of the transformer will be affected by any change in output voltage. Consult the transformer manufacturer for modifications to this component.

Capacitors C6 and C7, and diode D5 are all affected by the output voltage and may need to be changed depending on the direction and magnitude of the voltage change.

Any increase in power can have effects on a number of components. The NCP1000 can process power of at least 10 watts for a universal input, however the transformer, output rectifier (D5) and filter caps will need to be analyzed for their suitability.

### Component Substitutions

Similar components may be substituted for those on the parts list, however, there are certain parameters for some switching power supply components that need to be considered when doing so.

Rectifiers require the same voltage and current ratings as those specified. In addition, verify that their speed is equal to, or better than that of the specified device.

Capacitors in this type of power converter are subjected to very high rms switching currents. Any substitutions need to be checked to assure that the ripple current rating is better than, or equal to that of the specified device.

# AND8019/D

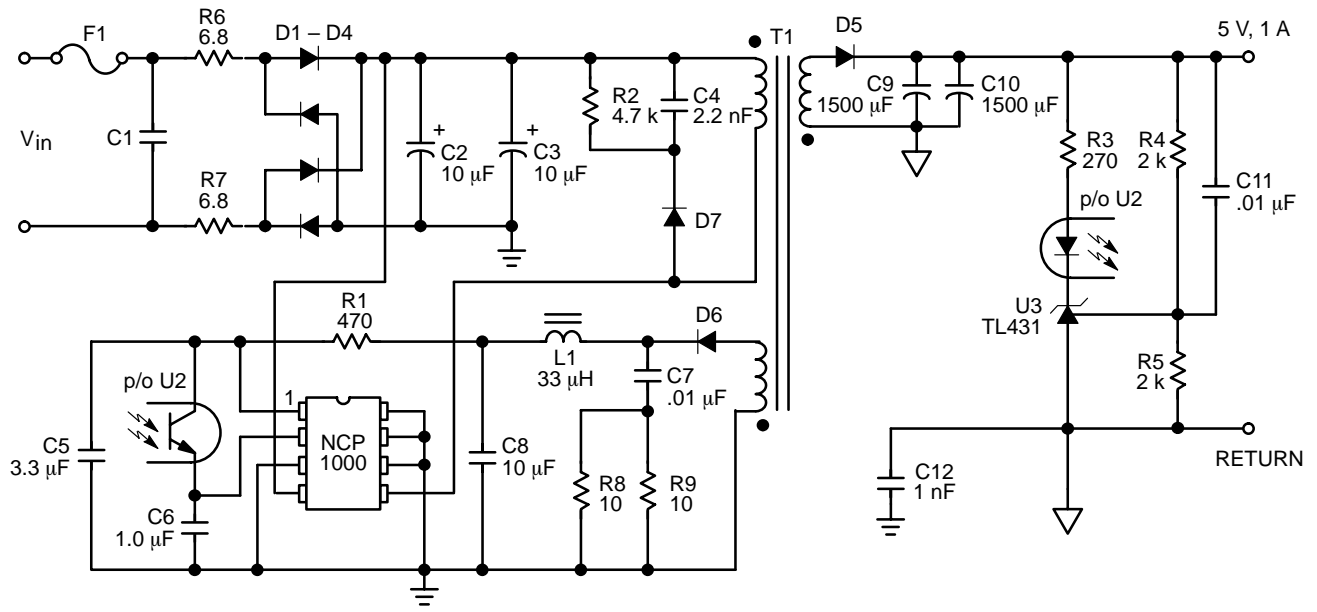
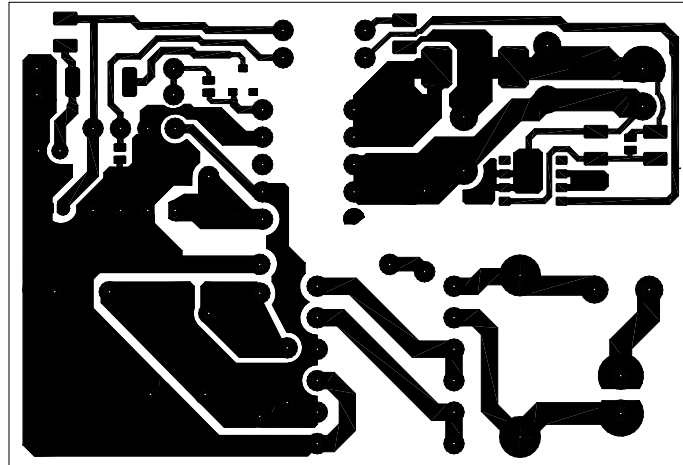

Figure 2. Schematic Diagram

# AND8019/D

## Printed Circuit Board



**Figure 3. Artwork – Viewed from Copper Side**  
Actual size is 2.50" x 1.70"

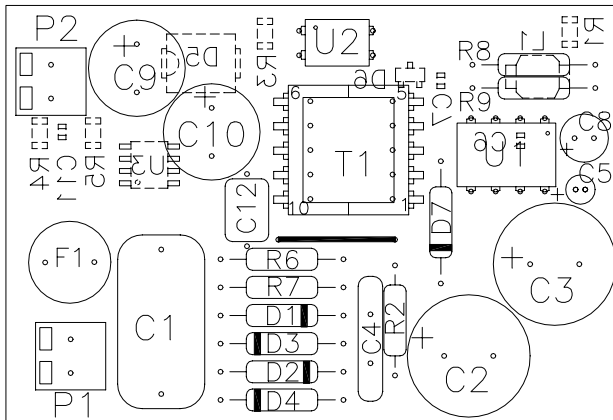

**Figure 4. Layout – Viewed from Component Side**

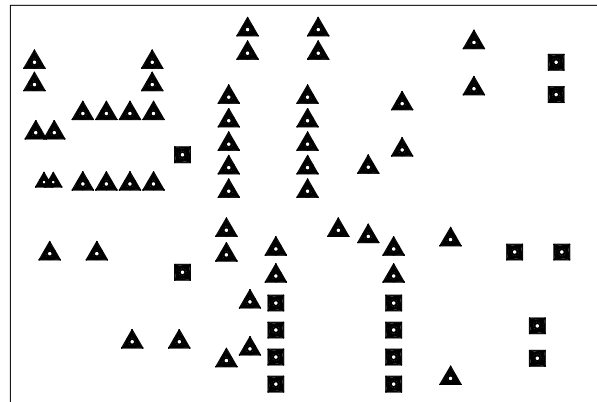

Sym	Size	Quan
▲	.032" ±.003"	52
■	.048" ±.003"	16

**Figure 5. Drill Drawing**

# AND8019/D

## Circuit Waveforms

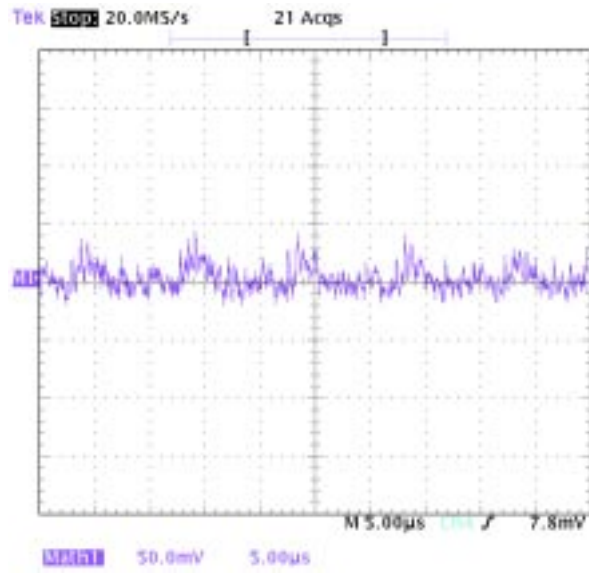

$V_{in} = 115 V_{rms}$   
1 Amp Load  
50 mV/div, 5 µs/div

Figure 6. Ripple

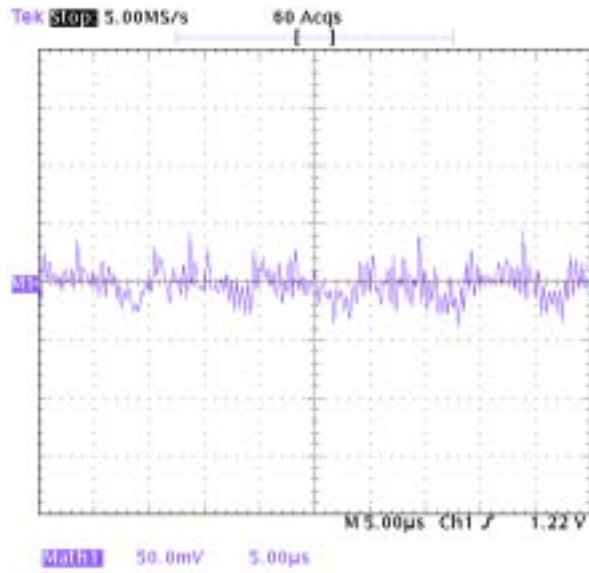

$V_{in} = 220 V_{rms}$   
1 Amp Load  
50 mV/div, 5 µs/div

Figure 7. Ripple



# AND8019/D

## Circuit Waveforms

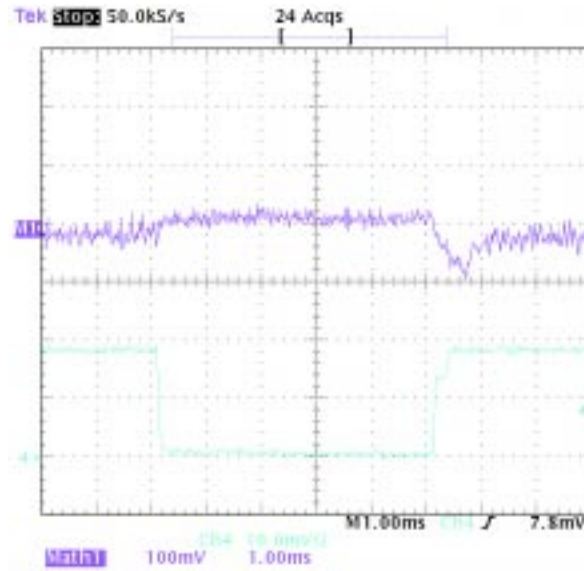

$V_{in} = 115 \text{ Vac}$

Top Trace:  
Output Voltage  
100 mV/div, 1 ms/div

Bottom Trace:  
0.1 Amps to 1 Amp

Figure 8. Transient Response

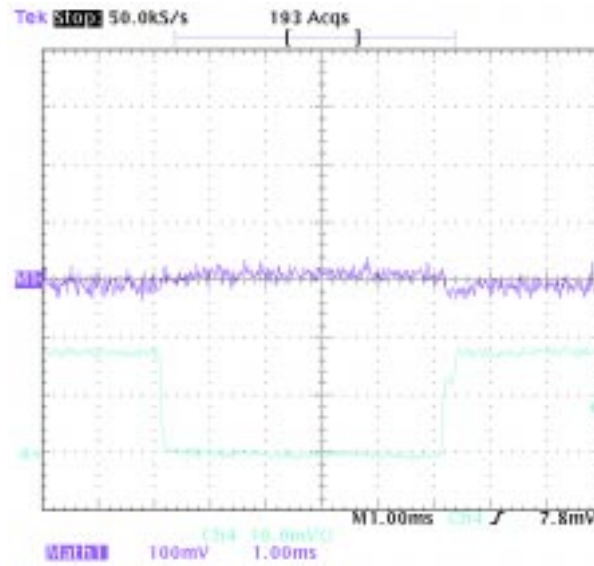

$V_{in} = 220 \text{ Vac}$

Top Trace:  
Output Voltage  
100 mV/div, 1 ms/div

Bottom Trace:  
0.1 Amps to 1 Amp

Figure 9. Transient Response

# AND8019/D

## Pin 5 Switching Waveforms

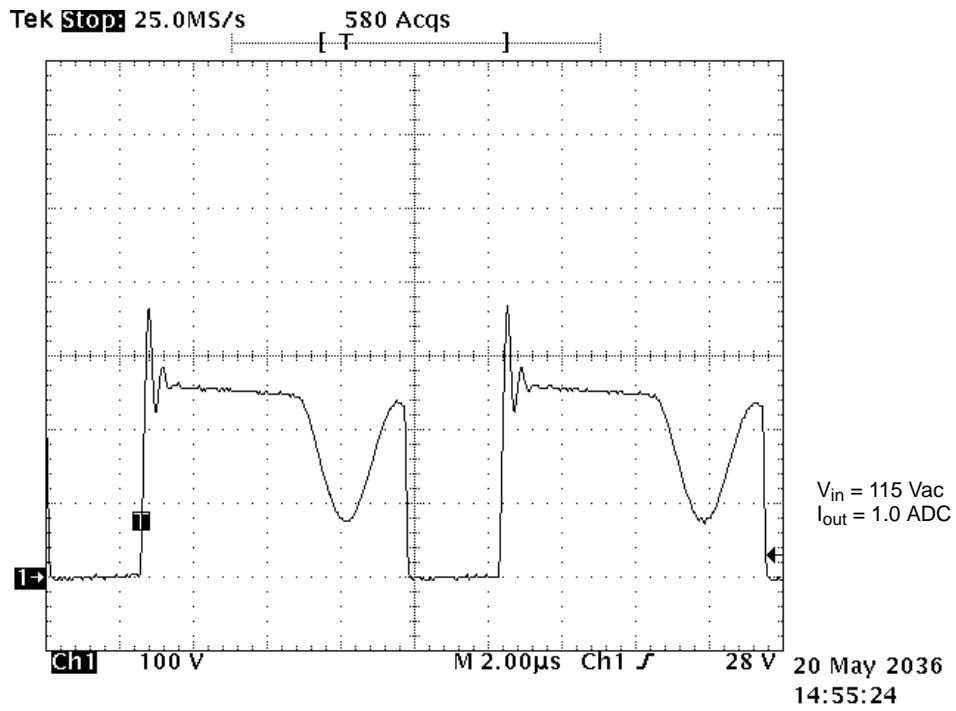

Figure 10. Switching Waveform  
(Pin 5 to Ground)

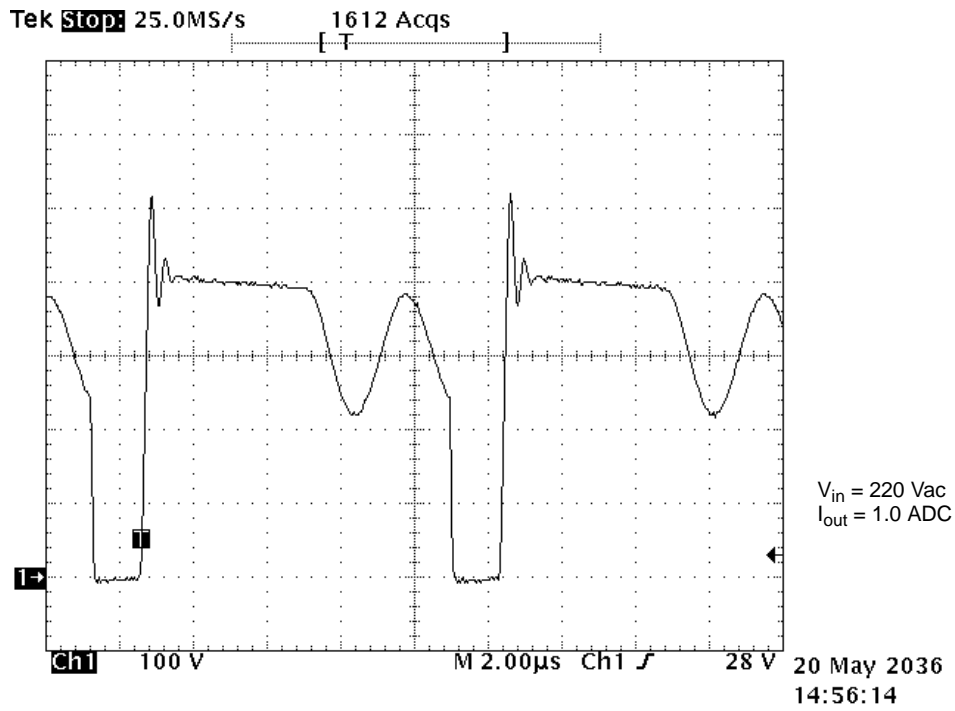



Figure 11. Switching Waveform  
(Pin 5 to Ground)

## Notes

## Notes

**ON Semiconductor** and  are registered trademarks of Semiconductor Components Industries, LLC (SCILLC). SCILLC reserves the right to make changes without further notice to any products herein. SCILLC makes no warranty, representation or guarantee regarding the suitability of its products for any particular purpose, nor does SCILLC assume any liability arising out of the application or use of any product or circuit, and specifically disclaims any and all liability, including without limitation special, consequential or incidental damages. "Typical" parameters which may be provided in SCILLC data sheets and/or specifications can and do vary in different applications and actual performance may vary over time. All operating parameters, including "Typicals" must be validated for each customer application by customer's technical experts. SCILLC does not convey any license under its patent rights nor the rights of others. SCILLC products are not designed, intended, or authorized for use as components in systems intended for surgical implant into the body, or other applications intended to support or sustain life, or for any other application in which the failure of the SCILLC product could create a situation where personal injury or death may occur. Should Buyer purchase or use SCILLC products for any such unintended or unauthorized application, Buyer shall indemnify and hold SCILLC and its officers, employees, subsidiaries, affiliates, and distributors harmless against all claims, costs, damages, and expenses, and reasonable attorney fees arising out of, directly or indirectly, any claim of personal injury or death associated with such unintended or unauthorized use, even if such claim alleges that SCILLC was negligent regarding the design or manufacture of the part. SCILLC is an Equal Opportunity/Affirmative Action Employer.

## PUBLICATION ORDERING INFORMATION

### Literature Fulfillment:

Literature Distribution Center for ON Semiconductor  
P.O. Box 5163, Denver, Colorado 80217 USA  
**Phone:** 303-675-2175 or 800-344-3860 Toll Free USA/Canada  
**Fax:** 303-675-2176 or 800-344-3867 Toll Free USA/Canada  
**Email:** ONlit@hibbertco.com

**N. American Technical Support:** 800-282-9855 Toll Free USA/Canada

**JAPAN:** ON Semiconductor, Japan Customer Focus Center  
4-32-1 Nishi-Gotanda, Shinagawa-ku, Tokyo, Japan 141-0031  
**Phone:** 81-3-5740-2700  
**Email:** r14525@onsemi.com

**ON Semiconductor Website:** <http://onsemi.com>

For additional information, please contact your local Sales Representative.