

# Preconfigured DSP System for Hearing Aids

## RHYTHM R3910

### Description

RHYTHM™ R3910 is a preconfigured hearing health processor based on a powerful DSP platform. Featuring iSceneDetect environmental classification, adaptive noise reduction, superior feedback cancellation, fully automated and adaptive microphone directionality, and up to 8-channel WDRC, the R3910 is ideal for high-end, full featured products. Available in one of the industry's smallest form-factors, it is well suited for all hearing aid types, including those placed deep in the ear canal.

**Acoustic Environment Classification** – The iSceneDetect 1.0 environmental classification algorithm is capable of analyzing the hearing aid wearer's acoustic environment and automatically optimizes the hearing aid to maximize comfort and audibility.

**iLog 4.0 Datalogging** – Enables the recording of various hearing aid parameters such as program selection, volume setting and ambient sound levels. The sampling interval can be configured to record from every 4 seconds up to once every 60 minutes. The fitting system can present the data to help the fitting specialist fine tune the hearing aid and counsel the wearer.

**EVOKE Advanced Acoustic Indicators** – Allows manufacturers to provide more pleasing, multi-frequency tones simulating musical notes or chords to indicate events such as program or volume changes.

**Automatic Adaptive Directionality** – The automatic Adaptive Directional Microphone (ADM) algorithm automatically reduces the level of sound sources that originate from behind or to the side of the hearing aid wearer without affecting sounds from the front. The algorithm can also gather input from the acoustic environment and automatically select whether directionality is needed or not, translating into additional current savings.

**Adaptive Feedback Canceller** – Automatically reduces acoustic feedback. It allows for an increase in the stable gain while minimizing artifacts for music and tonal input signals.

**Adaptive Noise Reduction** – The adaptive noise algorithm on R3910 monitors noise levels independently in 128 individual bands and employs advanced psychoacoustic models to provide user comfort.

**Tinnitus Masking** – R3910 is equipped with a noise source that can be used to mask tinnitus. The noise can be shaped and attenuated and then summed into the audio path either before or after the volume control.

**In-situ Tone Generator** – The narrow-band noise stimulus feature can be used for in-situ validation of the hearing aid fitting. The frequency, level and duration of the stimuli are individually adjustable.



ON Semiconductor®

[www.onsemi.com](http://www.onsemi.com)



25 PAD  
HYBRID  
CASE 127DN

### PAD CONNECTION

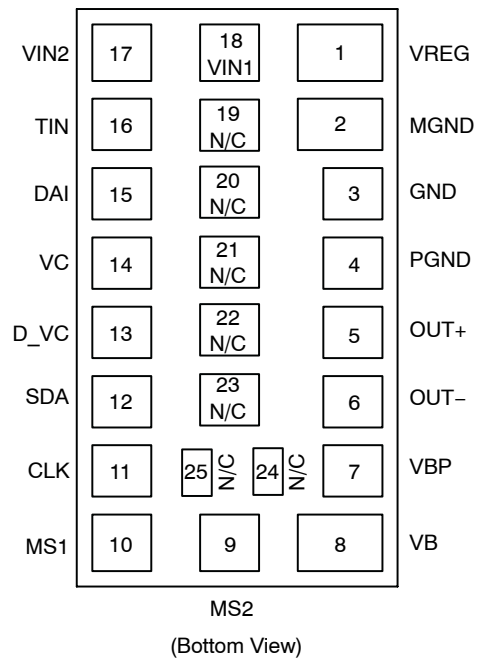

### MARKING DIAGRAM

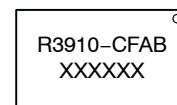

R3910-CFAB = Specific Device Code  
XXXXXX = Work Order Number

### ORDERING INFORMATION

See detailed ordering and shipping information on page 18 of this data sheet.

## RHYTHM R3910

**Other Key Features** – R3910 also supports the following features: Directional processing, built-in feedback path measurement, cross fading between audio paths for click-free program changes, 16-band graphic equalizer, 8 generic biquad filters (configurable as parametric or other filter types), programming speed enhancements, optional peak clipping, flexible compression adjustments, direct interfaces to analog or digital volume control, rocker switch, direct audio input and telecoil. R3910 also encompasses industry-leading security features to avoid cloning and software piracy.

### Features

- Advanced Research Algorithms:
  - ◆ iSceneDetect Environmental Classification
  - ◆ Automatic Adaptive Directional Microphones (ADM)
  - ◆ Directional Processing
  - ◆ 128-band Adaptive Noise Reduction
  - ◆ Adaptive Feedback Cancellation (AFC)
- iLog 4.0 Datalogging
- Tinnitus Masking Noise Generator
- Evoke Acoustic Indicators
- Auto Telecoil with Programmable Delay
- 1, 2, 4, 6 or 8 Channel WDRC
- Feedback Path Measurement Tool
- AGC-O with Variable Threshold, Time Constants, and Optional Adaptive Release
- 16-band Graphic Equalizer
- Narrow-Band Noise Stimulus
- SDA or I<sup>2</sup>C Programming
- 8 Biquadratic Filters
- 4 Analog Inputs
- 16 kHz or 8 kHz Bandwidth
- 6 Fully Configurable Memories with Audible Memory Change Indicator
- 96 dB Input Dynamic Range with Headroom Extension
- 128-bit Fingerprint Security System and Other Security Features to Protect Against Device Cloning and Software Piracy
- High Fidelity Audio CODEC
- Soft Acoustic Fade between Memory Changes
- Drives Zero-Bias 2-Terminal Receivers
- Internal or External Digital Volume Control with Programmable Range
- Rocker Switch Support
- Support for Active Hi or Active Lo Switching
- 20-bit Audio Processing
- E1 RoHS Compliant Hybrid
- These Devices are Pb-Free and are RoHS Compliant

### Packaging

- Hybrid Typical Dimensions:  
0.220 x 0.125 x 0.060 in.  
(5.59 x 3.18 x 1.52 mm)

# RHYTHM R3910

## BLOCK DIAGRAM

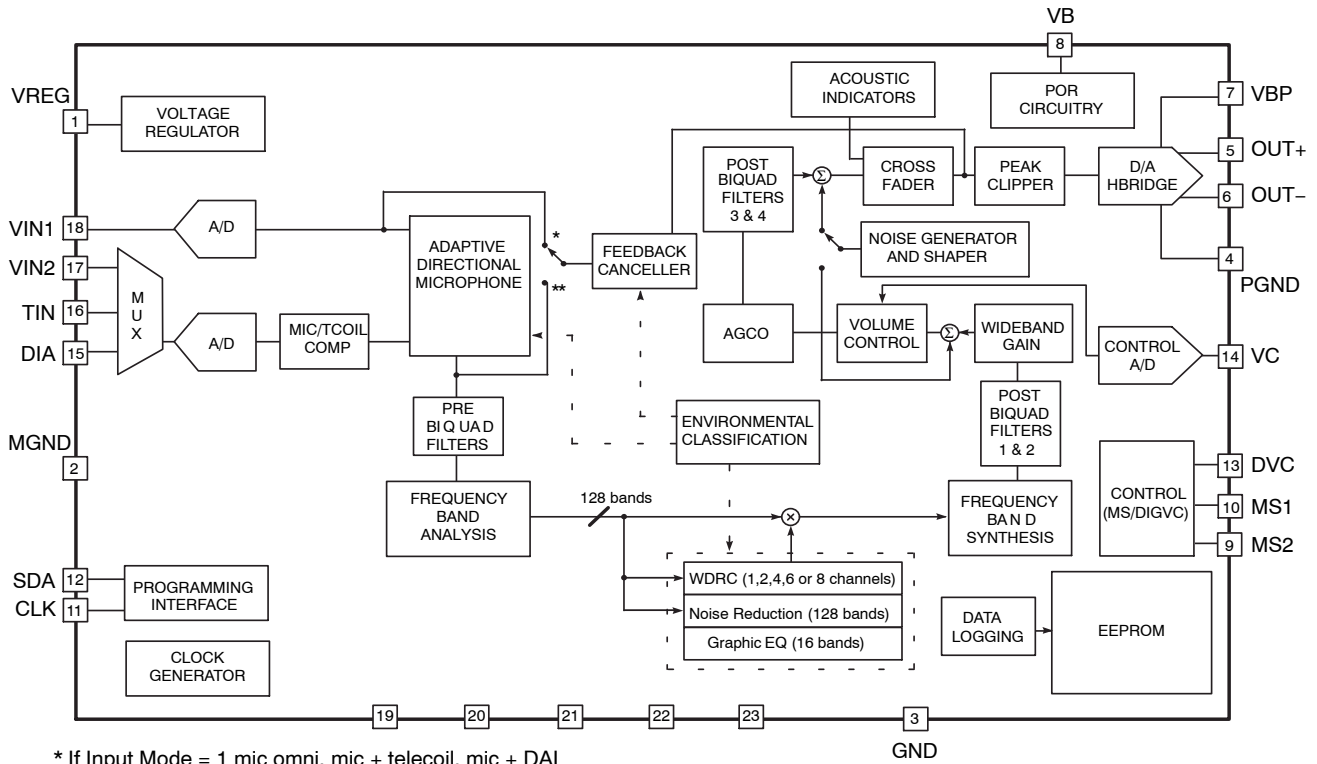

Figure 1. Hybrid Block Diagram

# RHYTHM R3910

## SPECIFICATIONS

**Table 1. ABSOLUTE MAXIMUM RATINGS**

| Parameter                          | Value      | Units |
|------------------------------------|------------|-------|
| Operating Temperature Range        | 0 to +40   | °C    |
| Storage Temperature Range          | -20 to +70 | °C    |
| Absolute Maximum Power Dissipation | 50         | mW    |
| Maximum Operating Supply Voltage   | 1.65       | VDC   |
| Absolute Maximum Supply Voltage    | 1.8        | VDC   |

Stresses exceeding those listed in the Maximum Ratings table may damage the device. If any of these limits are exceeded, device functionality should not be assumed, damage may occur and reliability may be affected.

**WARNING:** Electrostatic Sensitive Device – Do not open packages or handle except at a static-free workstation.

**WARNING:** Moisture Sensitive Device – RoHS Compliant; Level 3 MSL. Do not open packages except under controlled conditions.

**Table 2. ELECTRICAL CHARACTERISTICS** (Supply Voltage  $V_B = 1.25$  V; Temperature = 25°C)

| Parameter                        | Symbol           | Conditions                                  | Min   | Typ   | Max   | Units   |
|----------------------------------|------------------|---|-------|-------|-------|---------|
| Minimum Operating Supply Voltage | $V_{BOFF}$       | Ramp down, audio path                       | 0.93  | 0.95  | 0.97  | V       |
|                                  |                  | Ramp down, control logic                    | 0.77  | 0.80  | 0.83  |         |
| Supply Voltage Turn On Threshold | $V_{BON}$        | Ramp up, zinc-air                           | 1.06  | 1.10  | 1.16  | V       |
|                                  |                  | Ramp up, NiMH                               | 1.16  | 1.20  | 1.24  |         |
| Hybrid Current                   |                  | All functions, 32 kHz sampling rate         | -     | 665   | -     | $\mu$ A |
|                                  |                  | All functions, 16 kHz sampling rate         | -     | 575   | -     |         |
| EEPROM Burn Cycles               | -                | -   | 100 k | -     | -     | cycles  |
| Low Frequency System Limit       | -                | -   | -     | 125   | -     | Hz      |
| High Frequency System Limit      | -                | -   | -     | 16    | -     | kHz     |
| Total Harmonic Distortion        | THD              | $V_{IN} = -40$ dBV                          | -     | -     | 1     | %       |
| THD at Maximum Input             | THD <sub>M</sub> | $V_{IN} = -15$ dBV, Headroom Extension – ON | -     | -     | 3     | %       |
| Clock Frequency                  | $f_{CLK}$        | -   | 3.973 | 4.096 | 4.218 | MHz     |

### REGULATOR

|                   |                     |   |      |      |      |    |
|-------------------|---------------------|---|------|------|------|----|
| Regulator Voltage | $V_{REG}$           | -   | 0.87 | 0.90 | 0.93 | V  |
| System PSRR       | PSRR <sub>SYS</sub> | 1 kHz, Input referred, Headroom Extension enabled | -    | 70   | -    | dB |

### INPUT

|                                |               |  |      |      |      |            |
|--------------------------------|---------------|--|------|------|------|------------|
| Input Referred Noise           | IRN           | Bandwidth 100 Hz – 8 kHz                               | -    | -108 | -106 | dBV        |
| Input Impedance                | $Z_{IN}$      | 1 kHz  | -    | 3    | -    | M $\Omega$ |
| Anti-aliasing Filter Rejection | -             | $f = [DC - 112$ kHz], $V_{IN} = -40$ dBV               | -    | 80   | -    | dB         |
| Crosstalk                      | -             | Between both A/D and Mux                               | -    | 60   | -    | dB         |
| Maximum Input Level            | -             | -  | -    | -15  | -13  | dBV        |
| Analogue Input Voltage Range   | $V_{AN\_IN}$  | $V_{IN1}, V_{IN2}, AI$                                 | 0    | -    | 800  | mV         |
|                                | $V_{AN\_TIN}$ | $T_{IN}$   | -100 | -    | 800  |            |
| Input Dynamic Range            | -             | Headroom Extension – ON<br>Bandwidth<br>100 Hz – 8 kHz | -    | 95   | 96   | dB         |
| Audio Sampling Rate            | -             | -  | 8    | -    | 48   | kHz        |

### OUTPUT

|                   |   |                |   |    |   |    |
|-------------------|---|----------------|---|----|---|----|
| D/A Dynamic Range | - | 100 Hz – 8 kHz | - | 88 | - | dB |
|-------------------|---|----------------|---|----|---|----|

# RHYTHM R3910

**Table 2. ELECTRICAL CHARACTERISTICS** (Supply Voltage  $V_B = 1.25\text{ V}$ ; Temperature =  $25^\circ\text{C}$ ) (continued)

| Parameter   | Symbol     | Conditions                | Min   | Typ       | Max   | Units         |
|---|------------|---------------------------|-------|-----------|-------|---------------|
| <b>OUTPUT</b>   |            |                           |       |           |       |               |
| Output Impedance                                      | $Z_{OUT}$  | -                         | -     | 10        | 13    | $\Omega$      |
| <b>CONTROL A/D</b>                                    |            |                           |       |           |       |               |
| Resolution (monotonic)                                | -          | -                         | 7     | -         | -     | bits          |
| Zero Scale Level                                      | -          | -                         | -     | 0         | -     | V             |
| Full Scale Level                                      | -          | -                         | -     | $V_{REG}$ | -     | V             |
| <b>VOLUME CONTROL</b>                                 |            |                           |       |           |       |               |
| Volume Control Resistance                             | $R_{VC}$   | Three-terminal connection | 200   | -         | 1000  | $k\Omega$     |
| Volume Control Range                                  | -          | -                         | -     | -         | 42    | dB            |
| <b>PC_SDA INPUT</b>                                   |            |                           |       |           |       |               |
| Logic 0 Voltage                                       | -          | -                         | 0     | -         | 0.3   | V             |
| Logic 1 Voltage                                       | -          | -                         | 1     | -         | 1.25  | V             |
| <b>PC_SDA OUTPUT</b>                                  |            |                           |       |           |       |               |
| Stand-by Pull Up Current                              | -          | Creftrim = 6              | 3     | 5         | 6.5   | $\mu\text{A}$ |
| Sync Pull Up Current                                  | -          | Creftrim = 6              | 748   | 880       | 1020  | $\mu\text{A}$ |
| Max Sync Pull Up Current                              | -          | Creftrim = 15             | -     | 1380      | -     | $\mu\text{A}$ |
| Min Sync Pull Up Current                              | -          | Creftrim = 0              | -     | 550       | -     | $\mu\text{A}$ |
| Logic 0 Current (Pull Down)                           | -          | Creftrim = 6              | 374   | 440       | 506   | $\mu\text{A}$ |
| Logic 1 Current (Pull Up)                             | -          | Creftrim = 6              | 374   | 440       | 506   | $\mu\text{A}$ |
| Synchronization Time<br>(Synchronization Pulse Width) | $T_{SYNC}$ | Baud = 0                  | 237   | 250       | 263   | $\mu\text{s}$ |
|   |            | Baud = 1                  | 118   | 125       | 132   |               |
|   |            | Baud = 2                  | 59    | 62.5      | 66    |               |
|   |            | Baud = 3                  | 29.76 | 31.25     | 32.81 |               |
|   |            | Baud = 4                  | 14.88 | 15.63     | 16.41 |               |
|   |            | Baud = 5                  | 7.44  | 7.81      | 8.20  |               |
|   |            | Baud = 6                  | 3.72  | 3.91      | 4.10  |               |
|   |            | Baud = 7                  | 1.86  | 1.95      | 2.05  |               |

Product parametric performance is indicated in the Electrical Characteristics for the listed test conditions, unless otherwise noted. Product performance may not be indicated by the Electrical Characteristics if operated under different conditions.

# RHYTHM R3910

**Table 3. I<sup>2</sup>C TIMING**

| Parameter  | Symbol              | Standard Mode     |                    | Fast Mode                           |                   | Units |
|--|---------------------|-------------------|--------------------|-------------------------------------|-------------------|-------|
|  |                     | Min               | Max                | Min                                 | Max               |       |
| Clock Frequency  | f <sub>PC_CLK</sub> | 0                 | 100                | 0                                   | 400               | kHz   |
| Hold time (repeated) START condition. After this period, the first clock pulse is generated.               | t <sub>HD;STA</sub> | 4.0               | –                  | 0.6                                 | –                 | μsec  |
| LOW Period of the PC_CLK Clock   | t <sub>LOW</sub>    | 4.7               | –                  | –                                   | –                 | μsec  |
| HIGH Period of the PC_CLK Clock  | t <sub>HIGH</sub>   | 4.0               | –                  | –                                   | –                 | μsec  |
| Set-up time for a repeated START condition   | t <sub>SU;STA</sub> | 4.7               | –                  | –                                   | –                 | μsec  |
| Data Hold Time:<br>for CBUS Compatible Masters<br>for I <sup>2</sup> C-bus Devices                         | t <sub>HD;DAT</sub> | 5.0<br>0 (Note 1) | –<br>3.45 (Note 2) | –<br>0 (Note 1)                     | –<br>0.9 (Note 2) | μsec  |
| Data set-up time   | t <sub>SU;DAT</sub> | 250               | –                  | 100                                 | –                 | nsec  |
| Rise time of both PC_SDA and PC_CLK signals  | t <sub>r</sub>      | –                 | 1000               | 20 + 0.1 C <sub>b</sub><br>(Note 4) | 300               | nsec  |
| Fall time of both PC_SDA and PC_CLK signals  | t <sub>f</sub>      | –                 | 300                | 20 + 0.1 C <sub>b</sub><br>(Note 4) | 300               | nsec  |
| Set-up time for STOP condition   | t <sub>SU;STO</sub> | 4.0               | –                  | 0.6                                 | –                 | nsec  |
| Bus free time between a STOP and START condition   | t <sub>BUF</sub>    | 4.7               | –                  | 1.3                                 | –                 | μsec  |
| Output fall time from V <sub>IHmin</sub> to V <sub>ILmax</sub> with a bus capacitance from 10 pF to 400 pF | t <sub>of</sub>     | –                 | 250                | 20 + 0.1 C <sub>b</sub>             | 250               | nsec  |
| Pulse width of spikes which must be suppressed by the input filter   | t <sub>SP</sub>     | n/a               | n/a                | 0                                   | 50                | nsec  |
| Capacitive load for each bus line  | C <sub>b</sub>      | –                 | 400                | –                                   | 400               | pF    |

1. A device must internally provide a hold time of at least 300 ns for the PC\_SDA signal to bridge the undefined region of the falling edge of PC\_CLK.
2. The maximum t<sub>HD;DAT</sub> has only to be met if the device does not stretch the LOW period (t<sub>LOW</sub>) of the PC\_CLK signal.
3. A Fast-mode I<sup>2</sup>C-bus device can be used in a Standard-mode I<sup>2</sup>C-bus system, but the requirement t<sub>SU;DAT</sub> ≥ 250ns must then be met. This will automatically be the case if the device does not stretch the LOW period of the PC\_CLK signal. If such a device does stretch the LOW period of the PC\_CLK signal, it must output the next data bit to the PC\_SDA line t<sub>r</sub> max + t<sub>SU;DAT</sub> = 1000 + 250 = 1250 ns (according to the Standard-mode I<sup>2</sup>C-bus specification) before the PC\_CLK line is released.
4. C<sub>b</sub> = total capacitance of one bus line in pF.

# RHYTHM R3910

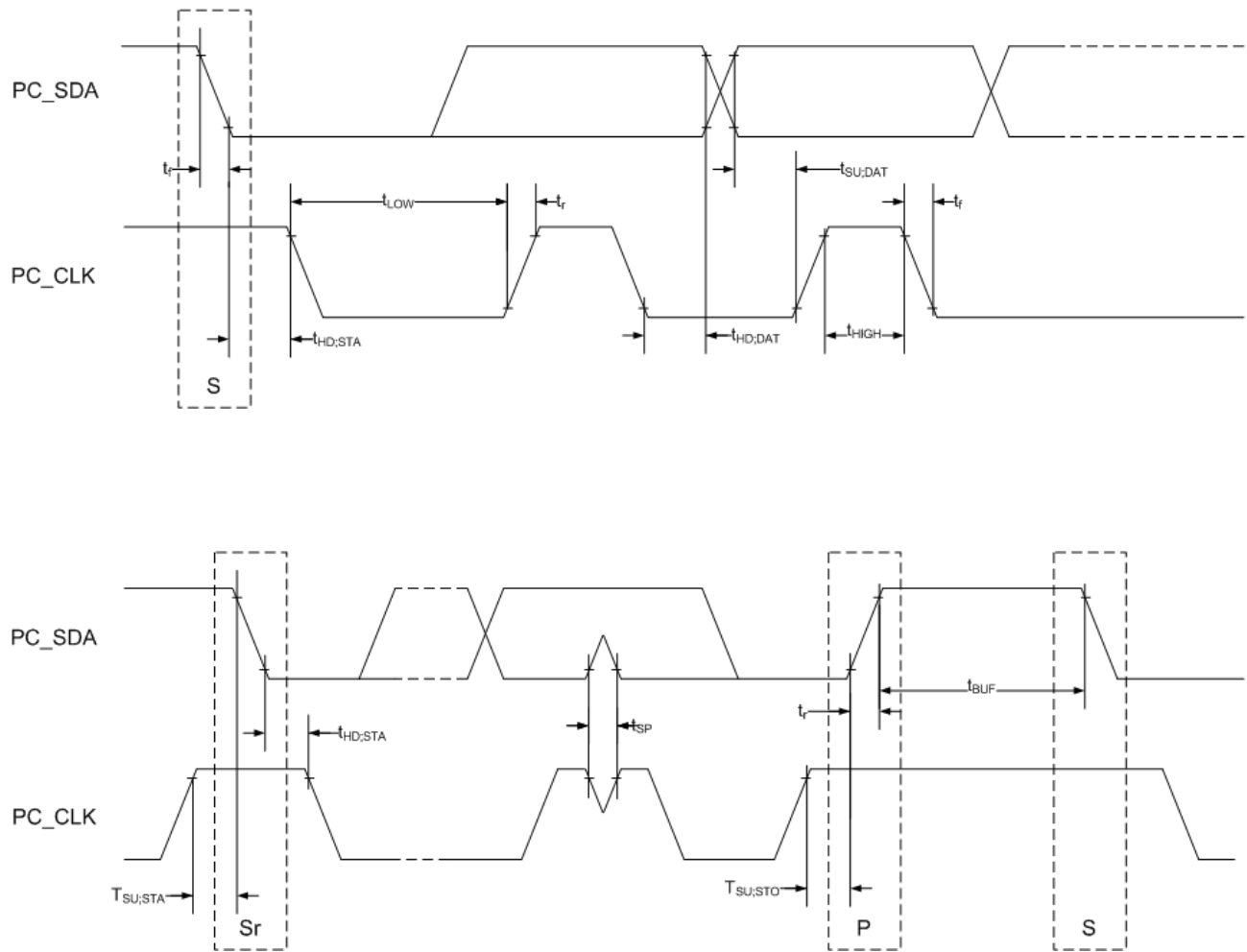

Figure 2. I<sup>2</sup>C Mode Timing

# RHYTHM R3910

## TYPICAL APPLICATIONS

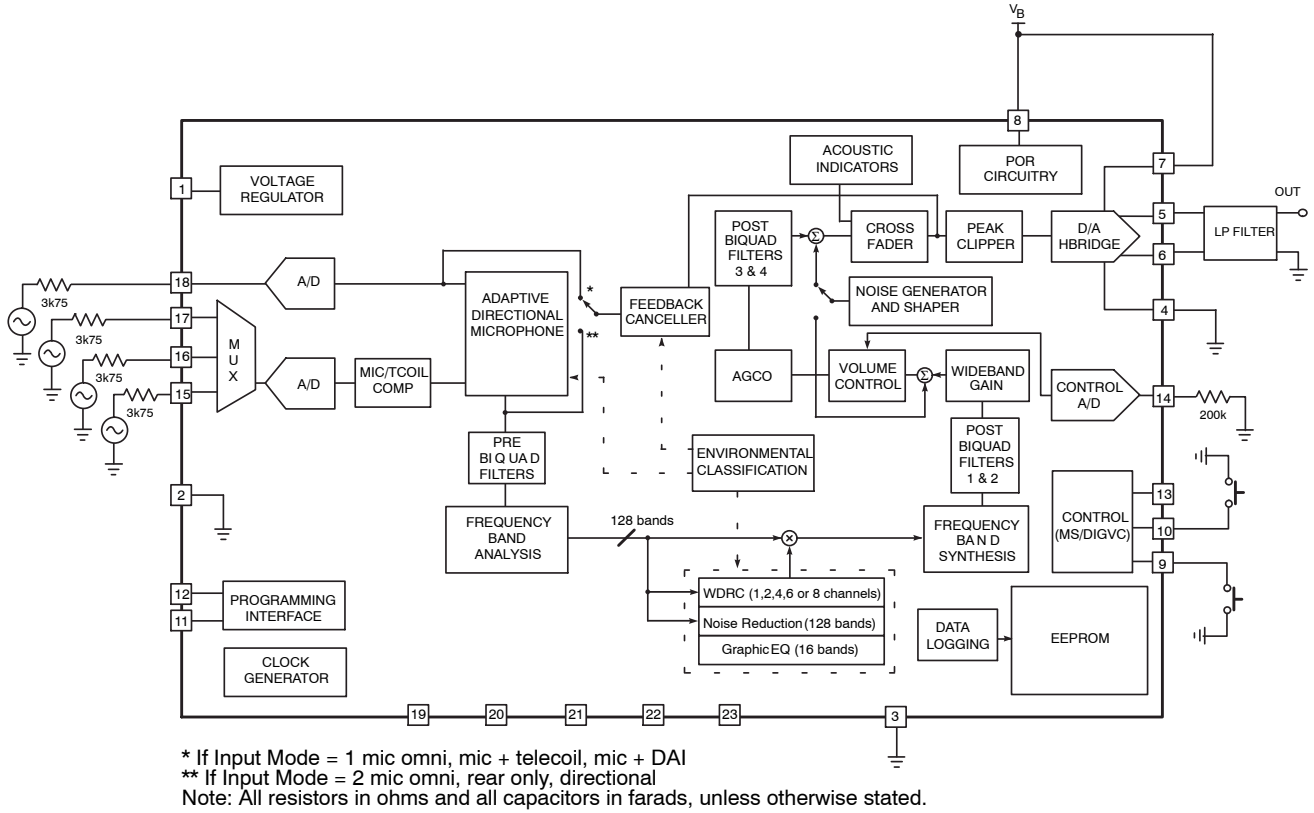

Figure 3. Test Circuit

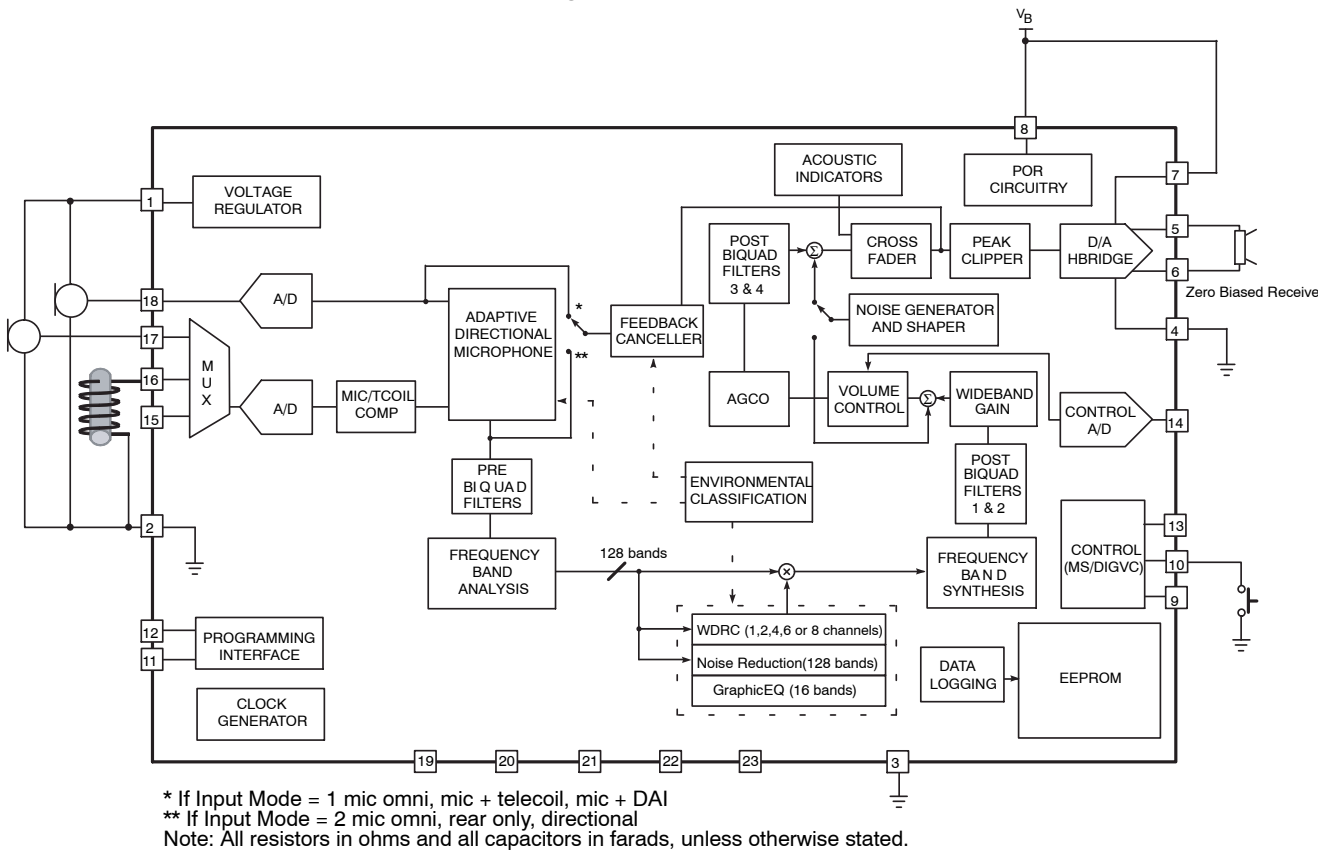

Figure 4. Typical Application Circuit



# RHYTHM R3910

## RHYTHM R3910 OVERVIEW

R3910 is a programmable multi-processor DSP platform implemented on a thin-stacked package. This DSP platform is the hearing industry's first 90 nm Silicon-on-Chip platform enabling design of highly-efficient and flexible hearing aid solutions. The multi-processor DSP system maximizing MIPS/ $\mu$ W with a unique reconfigurable architecture, integrated high-resolution dual ADC and a single DAC available in miniaturized package sizes, offering unmatched DSP processing capability and flexibility in an ultra small footprint with best in the industry power consumption. R3910 incorporates industry leading hearing algorithms allowing for easy integration into a wide range of hearing products.

The DSP core implements directional processing, programmable filters, adaptive algorithms, compression, wideband gain, and volume control. The adaptive algorithms include Adaptive Noise Reduction, Adaptive Feedback Cancellation and Automatic Adaptive Directional Microphones.

Adaptive Noise Reduction reduces audible noise in a low distortion manner while preserving perceived speech levels. The Adaptive Feedback Canceller reduces acoustic feedback while offering robust performance against pure tones. The Adaptive Directional Microphone algorithm automatically reduces the level of sound sources that originate from behind or from the side of the hearing-aid wearer without affecting sounds from the front. Additionally, the Automatic Adaptive Directional

Microphones algorithm automatically reduces current by turning off the second input channel if it is not needed.

The iLog 4.0 Datalogging feature records various parameters every 4 seconds to 60 minutes (programmable) during use of the device. Once these parameter values are read from the device, they can be used to counsel the user and fine tune the fitting.

iSceneDetect 1.0 is an classification algorithm that senses the users environment and automatically optimizes the hearing aid to maximize user comfort and audibility in that environment without any user interaction. R3910 supports iSceneDetect in 1 mic omni, static directional or adaptive directional modes.

R3910 comes with Evoke advanced acoustic indicators. Evoke allows manufacturers to provide more complex, multi-frequency tones, in addition to traditional programmable tones for memory changes and low battery indication, which can simulate musical notes or chords.

R3910 is equipped with a noise source that can be used in treating tinnitus. The Tinnitus Treatment noise can be shaped and attenuated and then summed into the audio path either before or after the volume control.

The Narrow-band Noise Stimulus feature allows the user to generate stimuli from the device that can be used for in situ audiometry. R3910 delivers advanced features and enhanced performance previously unavailable to a product in its class. As well, R3910 contains security features to protect clients' intellectual property against device cloning and software piracy.

## SIGNAL PATH

There are two main audio input signal paths. The first path contains the front microphone and the second path contains the rear microphone, telecoil or direct audio input as selected by a programmable MUX. The front microphone input is intended as the main microphone audio input for single microphone applications.

Analog input signals should be ground referenced to MGND (microphones, telecoils, DAI). MGND is internally connected to GND to minimize noise, and should not be connected to any external ground point.

In iSceneDetect, directional processing, ADM or Automatic ADM operation, a multi-microphone signal is used to produce a directional hearing aid response. The two audio inputs are buffered, sampled and converted into digital form using dual A/D converters. The digital outputs are converted into a 32 kHz or 16 kHz, 20-bit digital audio signal. Further IIR filter blocks process the front microphone and rear microphone signals. One biquad filter is used to match the rear microphone's gain to that of the front microphone. After that, other filtering is used to provide an adjustable group delay to create the desired polar response pattern during the calibration process. In iSceneDetect, ADM and Automatic ADM, the two

microphone inputs are combined in an adaptive way while in directional processing operation the combination is static.

In the telecoil mode gains are trimmed during Cal/Config process to compensate for microphone/telecoil mismatches.

The directional processing block is followed by four cascaded biquad filters: pre1, pre2, pre3 and pre4. These filters can be used for frequency response shaping before the signal goes through channel and adaptive processing.

The channel and adaptive processing consists of the following:

- Frequency band analysis
- 1, 2, 4, 6 or 8 channel WDRC
- 16 frequency shaping bands (spaced linearly at 500 Hz intervals, except for first and last bands)
- 128 frequency band adaptive noise reduction
- Frequency band synthesis

After the processing the signal goes through two more biquad filters, post1 and post2, which are followed by the AGC-O block. The AGC-O block incorporates the wideband gain and the volume control. There are also two

more biquad filters, post3 and post4, and the peak clipper. The last stage in the signal path is the D/A H-bridge.

White noise can be shaped, attenuated and then added into the signal path at two possible locations: before the volume control (between the wideband gain and the volume control) or after the volume control (between post 4 and the peak clipper) as shown in Figure 1.

**Functional Block Description**

**iSceneDetect 1.0 Environment Classification**

The iSceneDetect feature, when enabled, will sense the environment and automatically control the enhancement algorithms without any user involvement. It will detect speech in quiet, speech in noise, wind, music, quiet and noise environments and make the necessary adjustments to the parameters in the audio path, such as ADM, ANR, WDRC, FBC, in order to optimize the hearing aid settings for the specific environment.

iSceneDetect will gradually make the adjustments so the change in settings based on the environment is smooth and virtually unnoticeable. This feature will enable the hearing aid wearer to have an aid which will work in any environment with a single memory.

**EVOKE Advanced Acoustic Indicators**

Advanced acoustic indicators provide alerting sounds that are more complex, more pleasing and potentially more meaningful to the end user than the simple tones used on previous products. The feature is capable of providing pulsed, multi-frequency pure tones with smooth on and off transitions and also damped, multi-frequency tones that can simulate musical notes or chords.

A unique indicator sound can be assigned to each of the ten system events: memory select (A, B, C, D, E or F), low battery warning, digital VC movement and digital VC minimum/maximum. Each sound can consist of a number of either pure tones or damped tones but not both.

A pure tone sound can consist of up to four tones, each with a separate frequency, amplitude, duration and start time. Each frequency component is smoothly faded in and out with a fade time of 64 ms. The start time indicates the beginning of the fade in. The duration includes the initial fade-in period. By manipulating the frequencies, start times, durations and amplitudes various types of sounds can be obtained (e.g., various signalling tones in the public switched telephone network).

A damped tone sound can consist of up to six tones, each with a separate frequency, amplitude, duration, start time and decay time. Each frequency component starts with a sudden onset and then decays according to the specified time constant. This gives the audible impression of a chime or ring. By manipulating the frequencies, start times, durations, decays and amplitudes, various musical melodies can be obtained.

Acoustic indication can be used without the need to completely fade out the audio path. For example, the low-battery indicator can be played out and the user can still hear an attenuated version of the conversation.

**Adaptive Feedback Canceller**

The Adaptive Feedback Canceller reduces acoustic feedback by forming an estimate of the hearing aid feedback signal and then subtracting this estimate from the hearing aid input. The forward path of the hearing aid is not affected. Unlike adaptive notch filter approaches, the AFC does not reduce the hearing aid’s gain. The AFC is based on a time-domain model of the feedback path.

The third-generation AFC (see Figure 5) allows for an increase in the stable gain (see Note) of the hearing aid while minimizing artefacts for music and tonal input signals. As with previous products, the feedback canceller provides completely automatic operation.

NOTE: Added stable gain will vary based on hearing aid style and acoustic setup. Please refer to the Adaptive Feedback Cancellation information note for more details.

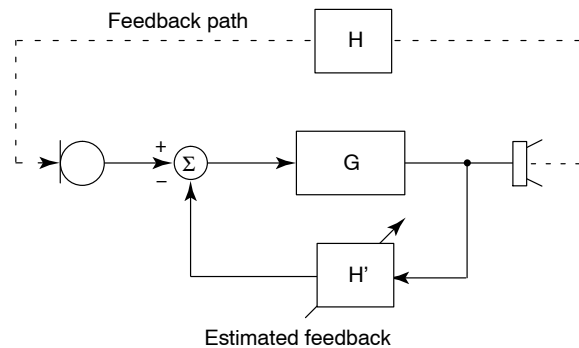

**Figure 5. Adaptive Feedback Canceller (AFC) Block Diagram**

**Feedback Path Measurement Tool**

The feedback path measurement tool uses the onboard feedback cancellation algorithm and noise generator to measure the acoustic feedback path of the device. The noise generator is used to create an acoustic output signal from the hearing aid, some of which leaks back to the microphone via the feedback path. The feedback canceller algorithm automatically calculates the feedback path impulse response by analyzing the input and output signals. Following a suitable adaptation period, the feedback canceller coefficients can be read out of the device and used as an estimate of the feedback-path impulse response.

**Adaptive Noise Reduction**

The noise reduction algorithm is built upon a high resolution 128-band filter bank enabling precise removal of noise. The algorithm monitors the signal and noise activities in these bands, and imposes a carefully calculated attenuation gain independently in each of the 128 bands.

The noise reduction gain applied to a given band is determined by a combination of three factors:

- Signal-to-Noise Ratio (SNR)
- Masking threshold
- Dynamics of the SNR per band

The SNR in each band determines the maximum amount of attenuation to be applied to the band – the poorer the SNR, the greater the amount of attenuation. Simultaneously, in each band, the masking threshold variations resulting from the energy in other adjacent bands is taken into account. Finally, the noise reduction gain is also adjusted to take advantage of the natural masking of ‘noisy’ bands by speech bands over time.

Based on this approach, only enough attenuation is applied to bring the energy in each ‘noisy’ band to just below the masking threshold. This prevents excessive amounts of attenuation from being applied and thereby reduces unwanted artifacts and audio distortion. The Noise Reduction algorithm efficiently removes a wide variety of types of noise, while retaining natural speech quality and level. The level of noise reduction (aggressiveness) is configurable to 3, 6, 9 and 12 dB of reduction.

### Directional Microphones

In any directional mode, the circuitry includes a fixed filter for compensating the sensitivity and frequency response differences between microphones. The filter parameters are adjusted during product calibration.

A dedicated biquad filter following the directional block has been allocated for low frequency equalization to compensate for the 6 dB/octave roll-off in frequency response that occurs in directional mode. The amount of low frequency equalization that is applied is programmable.

ON Semiconductor recommends using matched microphones. The maximum spacing between the front and rear microphones cannot exceed 20 mm (0.787 in).

### Adaptive Directional Microphones

The Adaptive Directional Microphone (ADM) algorithm from ON Semiconductor is a two-microphone processing scheme for hearing aids. It is designed to automatically reduce the level of sound sources that originate from behind or the side of the hearing-aid wearer without affecting sounds from the front. The algorithm accomplishes this by adjusting the null in the microphone polar pattern to minimize the noise level at the output of the ADM. The discrimination between desired signal and noise is based entirely on the direction of arrival with respect to the hearing aid: sounds from the front hemisphere are passed unattenuated whereas sounds arriving from the rear hemisphere are reduced.

The angular location of the null in the microphone polar pattern is continuously variable over a range of 90 to 180 degrees where 0 degrees represents the front.

The location of the null in the microphone pattern is influenced by the nature of the acoustic signals (spectral

content, direction of arrival) as well as the acoustical characteristics of the room. The ADM algorithm steers a single, broadband null to a location that minimizes the output noise power. If a specific noise signal has frequency components that are dominant, then these will have a larger influence on the null location than a weaker signal at a different location. In addition, the position of the null is affected by acoustic reflections. The presence of an acoustic reflection may cause a noise source to appear as if it originates at a location other than the true location. In this case, the ADM algorithm chooses a compromise null location that minimizes the level of noise at the ADM output.

### Automatic Adaptive Directional Microphones

When Automatic ADM mode is selected, the adaptive directional microphone remains enabled as long as the ambient sound level is above a specific threshold and the directional microphone has not converged to an omni-directional polar pattern. On the other hand, if the ambient sound level is below a specific threshold, or if the directional microphone has converged to an omni-directional polar pattern, then the algorithm will switch to single microphone, omni-directional state to reduce current consumption. While in this omni-directional state, the algorithm will periodically check for conditions warranting the enabling of the adaptive directional microphone.

### Directional Processing

The directional processing block provides the resources necessary to implement directional microphone processing. The block accepts inputs from both a front and rear microphone and provides a synthesized directional microphone signal as its output. The directional microphone output is obtained by delaying the rear microphone signal and subtracting it from the front microphone signal. Various microphone response patterns can be obtained by adjusting the time delay.

### In-Situ Datalogging – iLog 4.0

R3910 has a datalogging function that records information every 4 seconds to 60 minutes (programmable) about the state of the hearing aid and its environment to non-volatile memory. The function can be enabled with the ARK software and information collection will begin the next time the hybrid is powered up. This information is recorded over time and can be downloaded for analysis.

The following parameters are sampled:

- Battery level
- Volume control setting
- Program memory selection
- Environment
- Ambient sound level
- Length of time the hearing aid was powered on

The information is recorded using two methods in parallel:

- *Short-term method* – a circular buffer is serially filled with entries that record the state of the first five of the above variables at the configured time interval.
- *Long-term method* – increments a counter based on the memory state at the same time interval as that of the short-term method. Based on the value stored in the counter, length of time the hearing aid was powered on can be calculated.

There are 750 log entries plus 6 memory select counters which are all protected using a checksum verification. A new log entry is made whenever there is a change in memory state, volume control, or battery level state. A new log entry can also be optionally made when the environmental sound level changes more than the programmed threshold, thus it is possible to log only significantly large changes in the environmental level, or not log them at all.

The ARK software iLog graph displays the iLog data graphically in a way that can be interpreted to counsel the user and fine tune the fitting. This iLog graph can be easily incorporated into other applications or the underlying data can be accessed to be used in a custom display of the information.

### Tinnitus Treatment

R3910 has an internal white noise generator that can be used for Tinnitus Treatment. The noise can be attenuated to a level that will either mask or draw attenuation away from the user's tinnitus. The noise can also be shaped using low-pass and/or high-pass filters with adjustable slopes and corner frequencies.

As shown in Figure 1, the Tinnitus Treatment noise can be injected into the signal path either before or after the volume control (VC) or it can be disabled. If the noise is injected before the VC then the level of the noise will change along with the rest of the audio through the device when the VC is adjusted. If the noise is injected after the VC then it is not affected by VC changes.

The Tinnitus Treatment noise can be used on its own without the main audio path in a very low power mode by selecting the Tinnitus Treatment noise only. This is beneficial either when amplification is not needed at all by a user or if the user would benefit from having the noise supplied to them during times when they do not need acoustic cues but their sub-conscious is still active, such as when they are asleep.

The ARK software has a Tinnitus Treatment tool that can be used to explore the noise shaping options of this feature. This tool can also be easily incorporated into another software application.

If the noise is injected before the VC and the audio path is also enabled, the device can be set up to either have both the audio path and noise adjust via the VC or to have the noise only adjust via the VC. If the noise is injected after the VC, it is not affected by VC changes (see Table 4).

**Table 4. NOISE INJECTION EFFECT ON VC**

| Noise Insertion Modes | VC Controls   | Noise Injected |
|-----------------------|---------------|----------------|
| Off                   | Audio         | Off            |
| Pre VC                | Audio + Noise | Pre VC         |
| Post VC               | Audio         | Post VC        |
| Noise only Pre VC     | Noise         | Pre VC         |
| Noise only Post VC    | –             | Post VC        |
| Pre VC with Noise     | Noise         | Pre VC         |

### Narrow-band Noise Stimulus

R3910 is capable of producing Narrow-band Noise Stimuli that can be used for in situ audiometry. Each narrow-band noise is centred on an audiometric frequency. The duration of the stimuli is adjustable and the level of the stimuli are individually adjustable.

### A/D and D/A Converters

The system's two A/D converters are second order sigma-delta modulators operating at a 2.048 MHz sample rate. The system's two audio inputs are pre-conditioned with antialias filtering and programmable gain pre-amplifiers. These analog outputs are over-sampled and modulated to produce two, 1-bit Pulse Density Modulated (PDM) data streams. The digital PDM data is then decimated down to Pulse-Code Modulated (PCM) digital words at the system sampling rate of 32 kHz.

The D/A is comprised of a digital, third order sigma-delta modulator and an H-bridge. The modulator accepts PCM audio data from the DSP path and converts it into a 64-times or 128-times over-sampled, 1-bit PDM data stream, which is then supplied to the H-bridge. The H-bridge is a specialized CMOS output driver used to convert the 1-bit data stream into a low-impedance, differential output voltage waveform suitable for driving zero-biased hearing aid receivers.

### HRX Head Room Expander

R3910 has an enhanced Head Room Extension (HRX) circuit that increases the input dynamic range of the R3910 without any audible artifacts. This is accomplished by dynamically adjusting the pre-amplifier's gain and the post-A/D attenuation depending on the input level.

### Channel Processing

Figure 6 represents the I/O characteristic of independent AGC channel processing. The I/O curve can be divided into the following main regions:

- Low input level expansion (squelch) region
- Low input level linear region
- Compression region
- High input level linear region (return to linear)



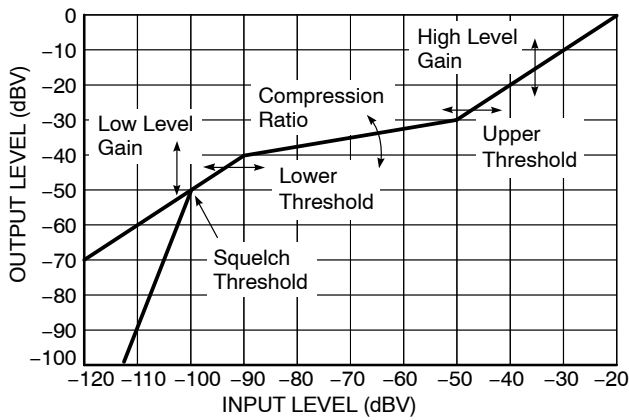

**Figure 6. Independent Channel I/O Curve Flexibility**

The I/O characteristic of the channel processing can be adjusted in the following ways:

- Squelch threshold (SQUELCHTH)
- Low level gain (LLGAIN)
- Lower threshold (LTH)
- High level gain (HLGAIN)
- Upper threshold (UTH)
- Compression ratio (CR)

To ensure that the I/O characteristics are continuous, it is necessary to limit adjustment to a maximum of four of the last five parameters. During Parameter Map creation, it is necessary to select four parameters as user adjustable, or fixed, and to allow one parameter to be calculated.

The squelch region within each channel implements a low level noise reduction scheme (1:2 or 1:3 expansion ratio) for listener comfort. This scheme operates in quiet listening environments (programmable threshold) to reduce the gain at very low levels. When the Squelch and AFC are both enabled it is highly recommended that the Squelch be turned on in all channels and that the Squelch thresholds be set above the microphone noise floor (see Adaptive Feedback Canceller).

The number of compression channels is programmable in ARKonline and can be 1, 2, 4, 6 or 8.

**Telecoil Path**

The telecoil input is calibrated during the Cal/Config process. To compensate for the telecoil/microphone frequency response mismatch, a first order filter with 500 Hz corner frequency is implemented. Through ARKonline, it is possible to implement a telecoil compensation filter with an adjustable corner frequency. To accommodate for the gain mismatch, the telecoil gain is adjusted to match the microphone gain at 500 Hz or 1 kHz (default) and is selectable in ARKonline.

There is also a telecoil gain adjustment parameter that can be enabled in ARKonline and set in the Interactive Data Sheet (IDS), enabling manual adjustment of the telecoil gain compensation.

**Automatic Telecoil**

R3910 is equipped with an automatic telecoil feature, which causes the hybrid to switch to a specific memory upon the closing of a switch connected to MS2. This feature is useful when MS2 is connected to a switch, such as a reed switch, that is open or closed depending on the presence of a static magnetic field. Memory D can be programmed to be the telecoil or mic+telecoil memory so that, when a telephone handset is brought close to such a switch, its static magnetic field closes the switch and causes the hybrid to change to memory D. However, it is possible that the hearing aid wearer may move his or her head away from the telephone handset momentarily, in which case it is undesirable to immediately change out of telecoil mode and then back in moments later.

R3910 has a debounce circuit that prevents this needless switching. The debounce circuit delays the device from switching out of memory D when MS2 is configured as a static switch in ‘D-only’ mode. The debounce time is programmable to be 1.5, 3.5 or 5.5 seconds after the switch opens (i.e., the handset is moved away from the hearing aid) or this feature can be disabled.

**DAI Path**

The DAI input can be adjusted using a first order filter with a variable corner frequency similar to the telecoil compensation filter. Through ARKonline, it is possible to implement this DAI filter to set either a static or adjustable corner frequency.

The Mic plus DAI mode mixes the Mic1 and DAI signals. The Mic1 input signal is attenuated by 0, -6 or -12 dB before being added to the DAI input signal. The DAI input also has gain adjustment in 1 dB steps to assist in matching it to the Mic1 input level.

**Graphic Equalizer**

R3910 has a 16-band graphic equalizer. The bands are spaced linearly at 500 Hz intervals, except for the first and the last band, and each one provides up to 24 dB of gain adjustment in 1 dB increments.

**Biquad Filters**

Additional frequency shaping can be achieved by configuring generic biquad filters. The transfer function for each of the biquad filters is as follows:

$$H(z) = \frac{b0 + b1 \times z^{-1} + b2 \times z^{-2}}{1 + a1 \times z^{-1} + a2 \times z^{-2}}$$

Note that the a0 coefficient is hard-wired to always be ‘1’. The coefficients are each 16 bits in length and include one sign bit, one bit to the left of the decimal point, and 14 bits to the right of the decimal point. Thus, before quantization, the floating-point coefficients must be in the range -2.0 ≤ x < 2.0 and quantized with the function:

$$\text{round}(x \times 2^{14})$$

# RHYTHM R3910

After designing a filter, the quantized coefficients can be entered into the PreBiquads or PostBiquads tab in the Interactive Data Sheet. The coefficients b0, b1, b2, a1, and a2 are as defined in the transfer function above. The parameters meta0 and meta1 do not have any effect on the signal processing, but can be used to store additional information related to the associated biquad.

The underlying code in the product components automatically checks all of the filters in the system for stability (i.e., the poles have to be within the unit circle) before updating the graphs on the screen or programming the coefficients into the hybrid. If the Interactive Data Sheet receives an exception from the underlying stability checking code, it automatically disables the biquad being modified and display a warning message. When the filter is made stable again, it can be re-enabled.

Also note that in some configurations, some of these filters may be used by the product component for microphone/telecoil compensation, low-frequency EQ, etc. If this is the case, the coefficients entered by the user into IDS are ignored and the filter designed by the software is programmed instead. For more information on filter design refer to the Biquad Filters In PARAGON® Digital Hybrid information note.

## Volume Control and Switches

### External Volume Control

The volume of the device can either be set statically via software or controlled externally via a physical interface.

R3910 supports both analog and digital volume control functionality, although only one can be enabled at a time. Digital control is supported with either a momentary switch or a rocker switch. In the latter case, the rocker switch can also be used to control memory selects.

### Analog Volume Control

The external volume control works with a three-terminal 100 kΩ – 360 kΩ variable resistor. The volume control can have either a log or linear taper, which is selectable via software. It is possible to use a VC with up to 1 MΩ of resistance, but this could result in a slight decrease in the resolution of the taper.

## Digital Volume Control

The digital volume control makes use of two pins for volume control adjustment, VC and D\_VC, with momentary switches connected to each. Closure of the switch to the VC pin indicates a gain increase while closure to the D\_VC pin indicates a gain decrease. Figure 7 shows how to wire the digital volume control to R3910.

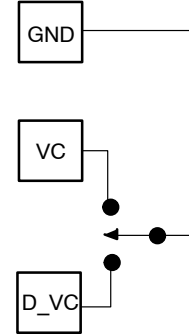

Figure 7. Wiring for Digital Volume Control

## Memory Select Switches

One or two, two-pole Memory Select (MS) switches can be used with R3910. This gives users tremendous flexibility in switching between configurations. Up to six memories can be configured and selected by the MS switches on R3910. Memory A must always be valid. The MS switches are either momentary or static and are fully configurable through IDS in the IDS setting tab.

The MS switch behavior is controlled by two main parameters in IDS:

- **MSSmode:** this mode determines whether a connected switch is momentary or static.
- **Only:** this parameter determines whether the MS2 switch is dedicated to the last memory position.

There are four MS switch modes of operation as shown in Table 5 below.

Table 5. MS Switch Modes

| MS Switch Mode | MS1 Switch | MS2 Switch | Max # of Valid Memories | Only | MSSMode   | Use                        |
|----------------|------------|------------|-------------------------|------|-----------|----------------------------|
| Mode 1         | Momentary  | None       | 6                       | Off  | Momentary | Simplest configuration     |
| Mode 2         | Momentary  | Static     | 6                       | On   | Momentary | Jump to last memory        |
| Mode 3         | Static     | Static     | 4                       | Off  | Static    | Binary selection of memory |
| Mode 4         | Static     | Static     | 3                       | On   | Static    | Jump to last memory        |

## RHYTHM R3910

The flexibility of the MS switches is further increased by allowing the MS switches to be wired to GND or VBAT, corresponding to an active low or active high logic level on

the MS pins. This option is configured with the MSPullUpDown/MS2PullUpDown setting in the IDS settings tab as shown in Table 6 below.

**Table 6. MS Switch Logic Levels vs. IDS PullUpDown Settings**

| “PullUpDown” Setting in IDS | MS switch state | MS input logic level | Switch connection |
|-----------------------------|-----------------|----------------------|-------------------|
| Pulldown                    | CLOSED          | HI                   | To VBAT           |
| Pulldown                    | OPEN            | LOW                  | To VBAT           |
| Pullup                      | CLOSED          | LOW                  | To GND            |
| Pullup                      | OPEN            | HI                   | To GND            |

In the following mode descriptions, it is assumed that the PullUpDown setting has been properly configured for the MS switch wiring so that a CLOSED switch state is at the correct input logic level.

**Mode 1: Momentary Switch on MS1**

This mode uses a single momentary switch on MS1 (Pin 10) to change memories. When using this mode the part starts in memory A, and whenever the button is pressed, the next valid memory is loaded. When the user is in the last valid memory, a button press causes memory A to be loaded.

This mode is set by programming the ‘MSSMode’ parameter to ‘Momentary’ and ‘Donly’ to ‘disabled’.

**Mode 1 Example:**

- If 6 valid memories: ABCDEFABCDEF...
- If 5 valid memories: ABCDEABCDE...
- If 4 valid memories: ABCDABCDA...
- If 3 valid memories: ABCABCA...
- If 2 valid memories: ABABA...
- If 1 valid memory: AAA...

**Mode 2 Example:**

- If MS2 = OPEN and there are 6 valid memories: ABCEFABCEF...
- If MS2 = OPEN and there are 5 valid memories: ABCEABCE...
- If MS2 = OPEN and there are 4 valid memories: ABCABCA...
- If MS2 = OPEN and there are 3 valid memories: ABABA...
- If Pull-up/Pull-down = Pull-down and MS2 = HIGH: D...
- If Pull-up/Pull-down = Pull-up and MS2 = LOW: D...

**Mode 2: Momentary Switch on MS1, Static Switch on MS2 (Jump to Last Memory)**

This mode uses a static switch on MS2 (Pin 9) and a momentary switch on MS1 (Pin 10) to change memories. If the static switch is OPEN, the part starts in memory A and behaves like momentary, with the exception that the highest valid memory (F if 6 memories selected) is not used. If the static switch on MS2 is set to CLOSED, the part automatically jumps to the highest valid memory location (occurs on startup or during normal operation). In this setup, the momentary switch’s state is ignored, preventing memory select beeps from occurring. When MS2 is set to OPEN, the part loads in the memory location selected before MS2 was closed.

This mode is set by programming the ‘MSSMode’ parameter to ‘Momentary’ and ‘Donly’ to ‘enabled’.

**Table 7. DYNAMIC EXAMPLE WITH FOUR VALID MEMORIES (T = MOMENTARY SWITCH IS TOGGLED; 0 = OPEN; 1 = CLOSED)**

|               |   |   |   |   |   |   |   |   |   |   |   |   |   |   |   |   |
|---------------|---|---|---|---|---|---|---|---|---|---|---|---|---|---|---|---|
| <b>MS2</b>    | 0 | 0 | 0 | 1 | 1 | 1 | 0 | 0 | 0 | 1 | 0 | 0 | 0 | 0 | 0 | 0 |
| <b>MS1</b>    | 0 | T | T | 0 | T | T | 0 | T | T | 0 | 0 | T | T | T | T | T |
| <b>Memory</b> | A | B | C | D | D | D | C | A | B | D | B | C | A | B | C | A |

### Mode 3: Static Switch on MS1 and MS2

This mode uses two static switches to change memories. Table 8 describes which memory is selected depending on the state of the switches.

In this mode, it is possible to jump from any memory to any other memory simply by changing the state of both switches. If both switches are changed simultaneously, then the transition is smooth. Otherwise, if one switch is changed and then the other, the part transitions to an intermediate memory before reaching the final memory. The part starts in whatever memory the switches are selecting. If a memory is invalid, the part defaults to memory A.

This mode is set by programming the ‘MSSMode’ parameter to ‘static’ and ‘Donly’ to ‘disabled’.

**Table 8. MEMORY SELECTED BY STATIC SWITCH ON MS1 AND MS2 MODE; (EXAMPLE WITH FOUR VALID MEMORIES)**

| MS1    | MS2    | Memory                    |
|--------|--------|---------------------------|
| OPEN   | OPEN   | A                         |
| CLOSED | OPEN   | B (if valid, otherwise A) |
| OPEN   | CLOSED | C (if valid, otherwise A) |
| CLOSED | CLOSED | D (if valid, otherwise A) |

### Mode 4: Static Switch on MS1, Static Switch on MS2 (Jump to Last Memory)

This mode uses two static switches to change memories. Unlike in the previous example, this mode will switch to the last valid memory when the static switch on MS2 is OPEN or CLOSED depending on the configuration of MS2. This means that this mode will only use a maximum of three memories (even if four valid memories are programmed). Tables 9 describes which memory is selected depending on the state of the switches.

This mode is set by programming the ‘MSSMode’ parameter to ‘static’ and ‘Donly’ to ‘enabled’.

**Table 9. MEMORY SELECTED BY STATIC SWITCH ON MS1, STATIC SWITCH ON MS2 (JUMP TO LAST MEMORY) MODE**

| MS1    | MS2    | Memory                    |
|--------|--------|---------------------------|
| OPEN   | OPEN   | A                         |
| CLOSED | OPEN   | B (if valid, otherwise A) |
| OPEN   | CLOSED | D                         |
| CLOSED | CLOSED | D                         |

In this mode, it is possible to jump from any memory to any other memory simply by changing the state of both switches. If both switches are changed simultaneously, then the transition is smooth. Otherwise, if one switch is changed and then the other, the part transitions to an intermediate memory before reaching the final memory.

When MS2 is set CLOSED, the state of the switch on MS1 is ignored. This prevents memory select beeps from occurring if switching MS1 when MS2 is CLOSED. The part starts in whatever memory the switches are selecting. If a memory is invalid, the part defaults to memory A. The part starts in whatever memory the switches are selecting. If a memory is invalid, the part defaults to memory A.

### AGC-O and Peak Clipper

The output compression-limiting block (AGC-O) is an output limiting circuit whose compression ratio is fixed at  $\infty : 1$ . The threshold level is programmable. The AGC-O module has programmable attack and release time constants.

The AGC-O on R3910 has optional adaptive release functionality. When this function is enabled, the release time varies depending on the environment. In general terms, the release time becomes faster in environments where the average level is well below the threshold and only brief intermittent transients exceed the threshold.

Conversely, in environments where the average level is close to the AGC-O threshold, the release time applied to portions of the signal exceeding the threshold is longer. The result is an effective low distortion output limiter that clamps down very quickly on momentary transients but reacts more smoothly in loud environments to minimize compression pumping artifacts. The programmed release time is the longest release time applied, while the fastest release time is 16 times faster. For example, if a release time of 128 ms is selected, the fastest release time applied by the AGC-O block is 8 ms.

R3910 also includes the Peak Clipper block for added flexibility.

### Memory Switch Fader

To minimize potential loud transients when switching between memories, R3910 uses a memory switch fader block. When the memory is changed, the audio signal is faded out, followed by the memory select acoustic indicators (if enabled), and after switching to the next memory, the audio signal is faded back in. The memory switch fader is also used when turning the Tone Generator on or off, and during SDA programming.

### Power Management

R3910 has three user-selectable power management schemes to ensure the hearing aid turns off gracefully at the end of battery life. shallow reset, deep reset and advanced reset mode. It also contains a programmable power on reset delay function.

### Power On Reset Delay

The programmable POR delay controls the amount of time between power being connected to the hybrid and the audio output being enabled. This gives the user time to



properly insert the hearing aid before the audio starts, avoiding the temporary feedback that can occur while the device is being inserted. During the delay period, momentary button presses are ignored.

**NOTE:** The values set in IDS are relative values from 0 to 11 seconds; not absolute. The POR delay is relative to the configuration loaded on the platform.

### Power Management Functionality

As the voltage on the hearing aid battery decreases, an audible warning is given to the user indicating the battery life is low. In addition to this audible warning, the hearing aid takes other steps to ensure proper operation given the weak supply. The exact hearing aid behaviour in low supply conditions depends on the selected POR mode. The hearing aid has three POR modes:

- Shallow Reset Mode
- Deep Reset Mode
- Advanced Mode

#### Shallow Reset Mode

In shallow reset mode, the hearing aid will operate normally when the battery is above 0.95 V. Once the supply voltage drops below 0.95 V the audio will be muted and remain in that state until the supply voltage rises above 1.1 V. Once the supply voltage drops below the control logic ramp down voltage, the device will undergo a hardware reset. At this point, the device will remain off until the supply voltage returns to 1.1 V. When the supply voltage is below the control logic voltage, but above 0.6 V and rises above the 1.1 V turn on threshold, the device will activate its output and operate from the memory that was active prior to reset. If the supply voltage drops below 0.6 V, and rises above the 1.1 V turn on threshold, the device will reinitialize, activate its output and operate from memory A.

#### Deep Reset Mode

In deep reset mode, the hearing aid will operate normally when the battery is above 0.95 V. Once the supply voltage drops below 0.95 V the audio will be muted. The device remains in this state until the supply voltage drops below the hardware reset voltage of 0.6 V. When this occurs, the device will load memory A and operate normally after the supply voltage goes above 1.1 V.

#### Advanced Reset Mode

Advanced reset mode on R3910 is a more sophisticated power management scheme than shallow and deep reset modes. This mode attempts to maximize the device's usable battery life by reducing the gain to stabilize the supply based on the instantaneous and average supply voltage levels. Instantaneous supply fluctuations below 0.95 V can trigger up to two 3 dB, instantaneous gain reductions. Average supply drops below 0.95 V can trigger up to eighteen, 1 dB average gain reductions.

While the average supply voltage is above 0.95 V, an instantaneous supply voltage fluctuation below 0.95 V will trigger an immediate 3 dB gain reduction. After the 3 dB gain reduction has been applied, the advanced reset model holds off checking the instantaneous voltage level for a monitoring period of 30 second in order to allow the voltage level to stabilize. If after the stabilization time the instantaneous voltage drops a second time below 0.95 V during the next monitoring period, the gain will be reduced an additional 3 dB for a 6 dB total reduction and a 30 second stabilization time is activated. The advanced reset mode continues to monitor the instantaneous voltage levels over 30 second monitoring periods. If the instantaneous voltage remains above 1.1 V during that monitoring period, the gain will be restored to the original setting regardless of whether one or two gain reductions are applied. If two gain reductions are applied and the instantaneous voltage level remains above 1.0 V for a monitoring period, the gain will be restored to a 3 dB reduction.

Should the average supply voltage drop below 0.95 V, the device will then reduce the gain by 1 dB every 10 seconds until either the average supply voltage rises above 0.95 V or a total of 18 average gain reductions have been applied, at which point the audio path will be muted. If the average supply voltage returns to a level above 1.1 V, the audio path will first be un-muted, if required. The gain will then be increased by 1 dB every 10 seconds until either the average supply voltage drops below 1.1 V, or all average gain reductions have been removed. No action is taken while the average supply voltage resides between 0.95 V and 1.1 V.

**NOTE:** Instantaneous and average gain reductions are adjusted independently.

When the instantaneous voltage falls below the hardware shutdown voltage, the device will undergo a hardware reset. When it turns back on because the voltage has risen above the turn-on threshold, it will behave the same as it would in shallow reset mode.

#### Low Battery Notification

Notification of the low battery condition via an acoustic indicator is optionally performed when the battery voltage drops below a configurable low battery notification threshold. The low battery indicator is repeated every five minutes until the device shuts down.

#### Software and Security

R3910 incorporates the following security features to protect the device from cloning and against software piracy:

- DLL protection by password – prevents a third party from using IDS to reconfigure parts.
- Hybrid authentication by 128-bit fingerprint to identify parts in application software – prevents a third party from cloning a device's EEPROM because the fingerprint cannot be overwritten. Special functions can

# RHYTHM R3910

be used in fitting software to reject parts that do not match the expected fingerprint. This would prevent the piracy of fitting software.

- DLL to hybrid pairing by using a software key in ARK to match product libraries with client software – a part can be ‘locked’ at manufacturing time so that it only communicates with the library it was programmed with. This prevents a third party from potentially upgrading a device with a different library in IDS or other application software.

Full software support is provided for every stage of development from design to manufacturing to fitting. For details, refer to the ARK User’s Guide.

### SDA and I<sup>2</sup>C Communication

R3910 can be programmed using the SDA or I<sup>2</sup>C protocol. During parameter changes, the main audio signal path of the hybrid is temporarily muted using the memory switch fader to avoid the generation of disturbing audio transients. Once the changes are complete, the main audio path is reactivated. Any changes made during programming are lost at power-off unless they are explicitly burned to EEPROM memory.

Improvements have been made to the ARK software for R3910 resulting in increased communication speed. Certain parameters in ARKonline can be selected to reduce the number of pages that need to be read out.

In SDA mode, R3910 is programmed via the SDA pin using industry standard programming boxes. I<sup>2</sup>C mode is a two wire interface which uses the SDA pin for bidirectional data and CLK as the interface clock input. I<sup>2</sup>C programming support is available on the HiPro (serial or USB versions) and ON Semiconductor’s DSP Programmer 3.0.

### Power Supply Considerations

R3910 was designed to accommodate high power applications. AC ripple on the supply can cause instantaneous reduction of the battery’s voltage, potentially disrupting the circuit’s function. R3910 hybrids have a separate power supply and ground connections for the output stage. This enables hearing aid designers to accommodate external RC filters to minimize any AC ripple from the supply line. Reducing this AC ripple greatly improves the stability of the circuit and prevents unwanted reset of the circuit caused by spikes on the supply line.

For more information on properly designing a filter to reduce supply ripple, refer to the Using DSP Hybrids in High Power Applications Initial Design Tips information note.

### Input Connection and Layout Considerations

It is recommended to connect unused audio input pins directly to MGND to minimize the possibility of noise pickup. Inputs are internally AC coupled, so there is no additional leakage current when inputs are connected directly to ground.

In order to further minimize noise at the inputs the following guidelines are recommended:

- MGND is used as reference ground plane for input signals. All input components should be grounded to MGND. This ground plane should be isolated from all other ground connections in the system.
- Keep the input traces as short as possible and avoid routing traces near high noise sources such as the OUT+ and OUT– pins
- Star ground input component grounds to the MGND connection.

### ORDERING INFORMATION

| Device         | Package                     | Shipping <sup>†</sup>   |
|----------------|-----------------------------|-------------------------|
| R3910-CFAB-E1B | 25 Pad Hybrid<br>Case 127DN | 25 Units / Bubble Pack  |
| R3910-CFAB-E1T | 25 Pad Hybrid<br>Case 127DN | 250 Units / Tape & Reel |

<sup>†</sup>For information on tape and reel specifications, including part orientation and tape sizes, please refer to our Tape and Reel Packaging Specifications Brochure, BRD8011/D.

### Hybrid Jig Ordering Information

To order a Hybrid Jig Evaluation Board for R3910 contact your Sales Account Manager or FAE and use part number SA3400GEVB.

# RHYTHM R3910

## PAD LOCATIONS

**Table 10. PAD POSITION AND DIMENSIONS**

| Pad No. | Pad Position |      | Pad Dimensions |            |
|---------|--------------|------|----------------|------------|
|         | X            | Y    | Xdim (mil)     | Ydim (mil) |
| 1       | 0            | 0    | 20             | 33         |
| 2       | -27          | 0    | 20             | 33         |
| 3       | -54          | -5   | 20             | 23         |
| 4       | -81          | -5   | 20             | 23         |
| 5       | -108         | -5   | 20             | 23         |
| 6       | -135         | -5   | 20             | 23         |
| 7       | -162         | -5   | 20             | 23         |
| 8       | -189         | 0    | 20             | 33         |
| 9       | -189         | 42   | 20             | 23         |
| 10      | -189         | 85   | 20             | 23         |
| 11      | -162         | 85   | 20             | 23         |
| 12      | -135         | 85   | 20             | 23         |
| 13      | -108         | 85   | 20             | 23         |
| 14      | -81          | 85   | 20             | 23         |
| 15      | -54          | 85   | 20             | 23         |
| 16      | -27          | 85   | 20             | 23         |
| 17      | 0            | 85   | 20             | 23         |
| 18      | 0            | 42   | 20             | 23         |
| 19      | -27          | 42   | 20             | 23         |
| 20      | -54          | 42   | 20             | 23         |
| 21      | -81          | 42   | 20             | 23         |
| 22      | -108         | 42   | 20             | 23         |
| 23      | -135         | 42   | 20             | 23         |
| 24      | -162         | 26.5 | 18             | 12         |
| 25      | -162         | 53.5 | 18             | 12         |

# RHYTHM R3910

**Table 10. PAD POSITION AND DIMENSIONS**

| Pad No. | X      | Y      | Xdim (mm) | Ydim (mm) |
|---------|--------|--------|-----------|-----------|
| 1       | 0      | 0      | 0.508     | 0.838     |
| 2       | -0.686 | 0      | 0.508     | 0.838     |
| 3       | -1.372 | -0.127 | 0.508     | 0.584     |
| 4       | -2.057 | -0.127 | 0.508     | 0.584     |
| 5       | -2.743 | -0.127 | 0.508     | 0.584     |
| 6       | -3.429 | -0.127 | 0.508     | 0.584     |
| 7       | -4.115 | -0.127 | 0.508     | 0.584     |
| 8       | -4.801 | 0      | 0.508     | 0.838     |
| 9       | -4.801 | 1.067  | 0.508     | 0.584     |
| 10      | -4.801 | 2.159  | 0.508     | 0.584     |
| 11      | -4.115 | 2.159  | 0.508     | 0.584     |
| 12      | -3.429 | 2.159  | 0.508     | 0.584     |
| 13      | -2.743 | 2.159  | 0.508     | 0.584     |
| 14      | -2.057 | 2.159  | 0.508     | 0.584     |
| 15      | -1.372 | 2.159  | 0.508     | 0.584     |
| 16      | -0.686 | 2.159  | 0.508     | 0.584     |
| 17      | 0      | 2.159  | 0.508     | 0.584     |
| 18      | 0      | 1.067  | 0.508     | 0.584     |
| 19      | -0.686 | 1.067  | 0.508     | 0.584     |
| 20      | -1.372 | 1.067  | 0.508     | 0.584     |
| 21      | -2.057 | 1.067  | 0.508     | 0.584     |
| 22      | -2.743 | 1.067  | 0.508     | 0.584     |
| 23      | -3.429 | 1.067  | 0.508     | 0.584     |
| 24      | -4.115 | 0.673  | 0.457     | 0.305     |
| 25      | -4.115 | 1.359  | 0.457     | 0.305     |

# MECHANICAL CASE OUTLINE

## PACKAGE DIMENSIONS

ON Semiconductor®

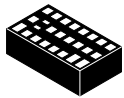

SCALE 2:1

SIP25, 5.59x3.18  
CASE 127DN  
ISSUE A

DATE 21 JUL 2020

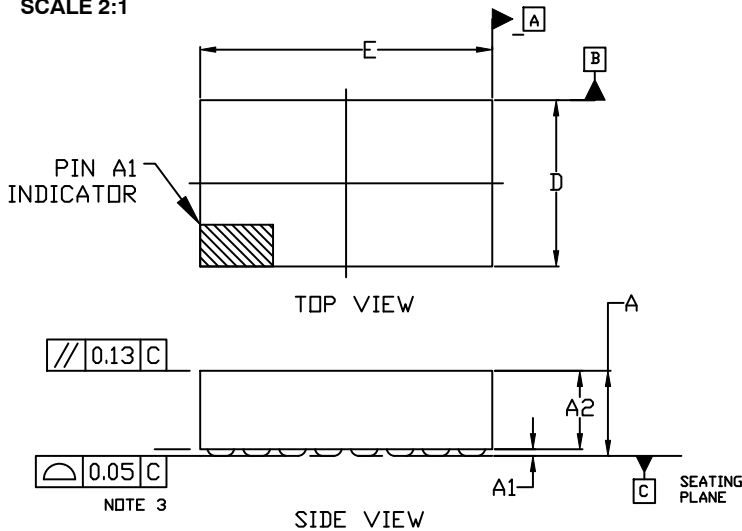

NOTES:

1. DIMENSIONING AND TOLERANCING PER ASME Y14.5M, 2009.
2. CONTROLLING DIMENSION: MILLIMETERS
3. COPLANARITY APPLIES TO THE SPHERICAL CROWNS OF THE PADS.

| DIM | MILLIMETERS |       |       |
|-----|-------------|-------|-------|
|     | MIN.        | NDM.  | MAX.  |
| A   | ---         | ---   | 1.68  |
| A1  | 0.08        | 0.13  | 0.18  |
| A2  | ---         | ---   | 1.50  |
| b   | 0.478       | 0.508 | 0.538 |
| b1  | 0.427       | 0.457 | 0.487 |
| D   | 3.05        | 3.18  | 3.31  |
| E   | 5.46        | 5.59  | 5.72  |
| e   | 0.686 BSC   |       |       |
| e1  | 0.051 BSC   |       |       |
| e2  | 1.067 BSC   |       |       |
| e3  | 1.092 BSC   |       |       |
| L   | 0.554       | 0.584 | 0.614 |
| L2  | 0.808       | 0.838 | 0.868 |
| L3  | 0.275       | 0.305 | 0.335 |

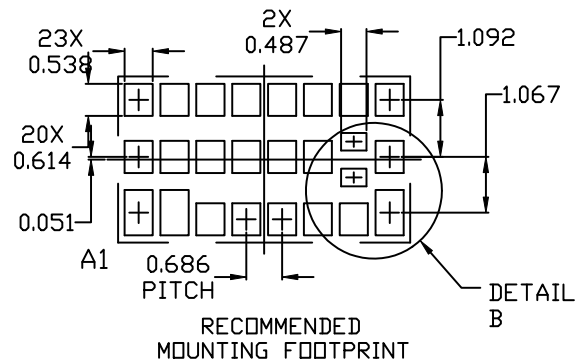
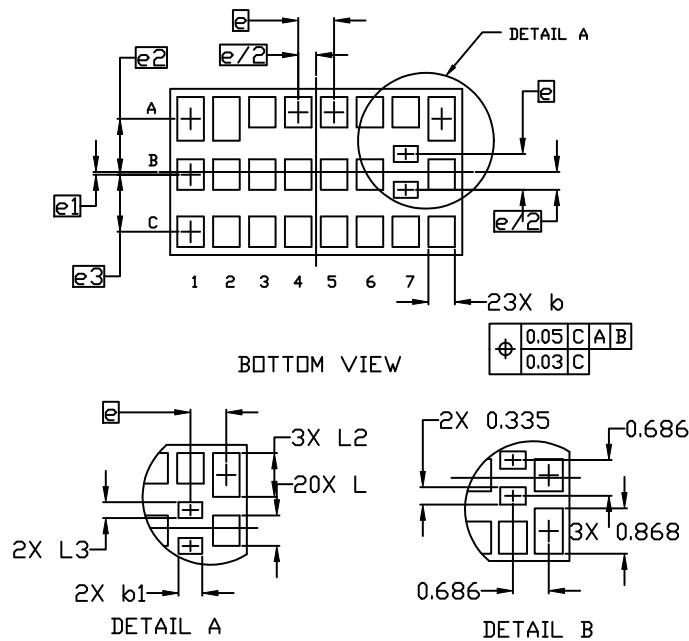

\* For additional information on our Pb-Free strategy and soldering details, please download the ON Semiconductor Soldering and Mounting Techniques Reference Manual, SOLDERRM/D.

GENERIC MARKING DIAGRAM\*

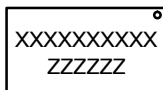

XX = Specific Device Code  
ZZ = Lot Traceability

\*This information is generic. Please refer to device data sheet for actual part marking. Pb-Free indicator, "G" or microdot "•", may or may not be present. Some products may not follow the Generic Marking.

|                  |                  |  |
|------------------|------------------|--|
| DOCUMENT NUMBER: | 98AON89696F      | Electronic versions are uncontrolled except when accessed directly from the Document Repository. Printed versions are uncontrolled except when stamped "CONTROLLED COPY" in red. |
| DESCRIPTION:     | SIP25, 5.59x3.18 | PAGE 1 OF 1  |

ON Semiconductor and ON are trademarks of Semiconductor Components Industries, LLC dba ON Semiconductor or its subsidiaries in the United States and/or other countries. ON Semiconductor reserves the right to make changes without further notice to any products herein. ON Semiconductor makes no warranty, representation or guarantee regarding the suitability of its products for any particular purpose, nor does ON Semiconductor assume any liability arising out of the application or use of any product or circuit, and specifically disclaims any and all liability, including without limitation special, consequential or incidental damages. ON Semiconductor does not convey any license under its patent rights nor the rights of others.

**onsemi**, **Onsemi**, and other names, marks, and brands are registered and/or common law trademarks of Semiconductor Components Industries, LLC dba "**onsemi**" or its affiliates and/or subsidiaries in the United States and/or other countries. **onsemi** owns the rights to a number of patents, trademarks, copyrights, trade secrets, and other intellectual property. A listing of **onsemi**'s product/patent coverage may be accessed at [www.onsemi.com/site/pdf/Patent-Marking.pdf](http://www.onsemi.com/site/pdf/Patent-Marking.pdf). **onsemi** reserves the right to make changes at any time to any products or information herein, without notice. The information herein is provided "as-is" and **onsemi** makes no warranty, representation or guarantee regarding the accuracy of the information, product features, availability, functionality, or suitability of its products for any particular purpose, nor does **onsemi** assume any liability arising out of the application or use of any product or circuit, and specifically disclaims any and all liability, including without limitation special, consequential or incidental damages. Buyer is responsible for its products and applications using **onsemi** products, including compliance with all laws, regulations and safety requirements or standards, regardless of any support or applications information provided by **onsemi**. "Typical" parameters which may be provided in **onsemi** data sheets and/or specifications can and do vary in different applications and actual performance may vary over time. All operating parameters, including "Typicals" must be validated for each customer application by customer's technical experts. **onsemi** does not convey any license under any of its intellectual property rights nor the rights of others. **onsemi** products are not designed, intended, or authorized for use as a critical component in life support systems or any FDA Class 3 medical devices or medical devices with a same or similar classification in a foreign jurisdiction or any devices intended for implantation in the human body. Should Buyer purchase or use **onsemi** products for any such unintended or unauthorized application, Buyer shall indemnify and hold **onsemi** and its officers, employees, subsidiaries, affiliates, and distributors harmless against all claims, costs, damages, and expenses, and reasonable attorney fees arising out of, directly or indirectly, any claim of personal injury or death associated with such unintended or unauthorized use, even if such claim alleges that **onsemi** was negligent regarding the design or manufacture of the part. **onsemi** is an Equal Opportunity/Affirmative Action Employer. This literature is subject to all applicable copyright laws and is not for resale in any manner.

---

## ADDITIONAL INFORMATION

### TECHNICAL PUBLICATIONS:

Technical Library: [www.onsemi.com/design/resources/technical-documentation](http://www.onsemi.com/design/resources/technical-documentation)  
onsemi Website: [www.onsemi.com](http://www.onsemi.com)

### ONLINE SUPPORT: [www.onsemi.com/support](http://www.onsemi.com/support)

For additional information, please contact your local Sales Representative at [www.onsemi.com/support/sales](http://www.onsemi.com/support/sales)