

Q1 3-Phase TNPC Module

NXH40T120L3Q1

The NXH40T120L3Q1 is a power module containing a three channel T-type neutral-point clamped (TNPC) circuit. Each channel has two 1200 V, 40 A IGBTs with inverse diodes and two 650 V, 25 A IGBTs with inverse diodes. The module contains an NTC thermistor.

Features

- Low Package Height
- Compact 82.5 mm x 37.4 mm x 12 mm Package
- Options with Press-fit Pins and Solder Pins
- Options with Pre-applied Thermal Interface Material (TIM) and without Pre-applied TIM
- Thermistor
- This Device is Pb-Free and is RoHS Compliant

Applications

- Solar Inverters
- UPS
- Energy Storage Systems

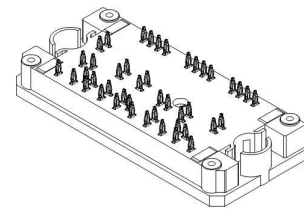

**Q1 3-TNPC
CASE 180AS**
Solder pins follow similar pattern

MARKING DIAGRAM

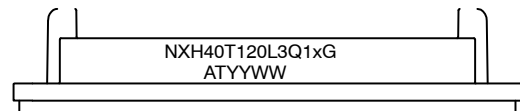

NXH40T120L3Q1x = Device Code
A = Assembly Site Code
T = Test Site Code
YYWW = Year and Work Week Code
G = Pb-Free Package

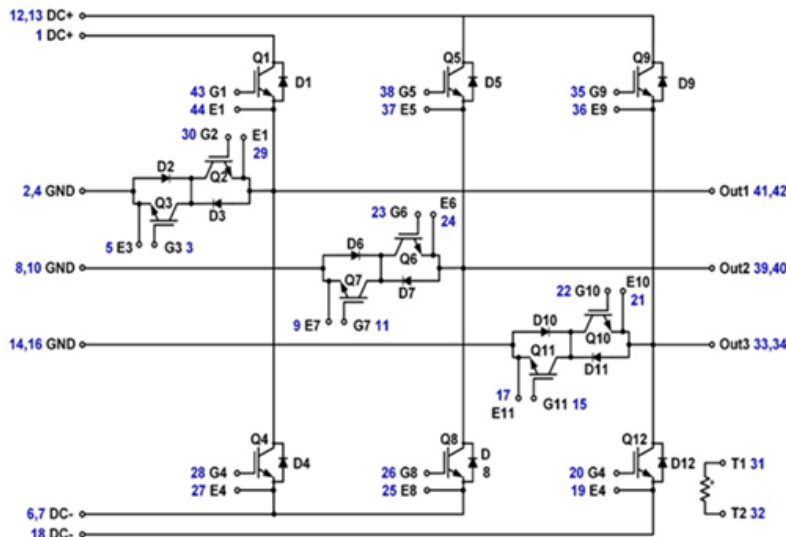
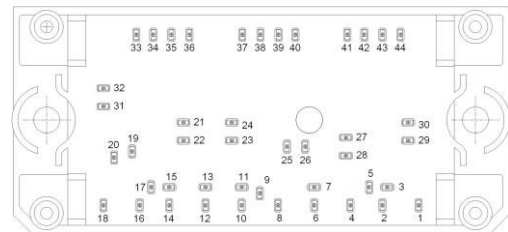

Figure 1. NXH40T120L3Q1 Schematic Diagram

PIN CONNECTIONS



ORDERING INFORMATION

See detailed ordering and shipping information on page 5 of this data sheet.

NXH40T120L3Q1

MAXIMUM RATINGS (Note 1)

Rating	Symbol	Value	Unit
IGBT (Q1, Q4, Q5, Q8, Q9, Q12)			
Collector – Emitter Voltage	V _{CES}	1200	V
Gate – Emitter Voltage	V _{GE}	±20	V
Continuous Collector Current @ T _C = 80°C (T _J = 175°C)	I _C	40	A
Pulsed Collector Current (T _J = 175°C)	I _{Cpulse}	120	A
Maximum Power Dissipation (T _J = 175°C)	P _{tot}	145	W
Minimum Operating Junction Temperature	T _{JMIN}	-40	°C
Maximum Operating Junction Temperature	T _{JMAX}	175	°C

DIODE (D1, D4, D5, D8, D9, D12)

Peak Repetitive Reverse Voltage	V _{RRM}	1200	V
Continuous Forward Current @ T _C = 80°C (T _J = 175°C)	I _F	25	A
Repetitive Peak Forward Current (T _J = 175°C)	I _{FRM}	75	A
Maximum Power Dissipation (T _J = 175°C)	P _{tot}	55	W
Minimum Operating Junction Temperature	T _{JMIN}	-40	°C
Maximum Operating Junction Temperature	T _{JMAX}	175	°C

IGBT+DIODE (Q2+D2, Q3+D3, Q6+D6, Q7+D7, Q10+D10, Q11+D11)

Collector – Emitter Voltage	V _{CES}	650	V
Gate – Emitter Voltage	V _{GE}	±20	V
Continuous Collector Current @ T _C = 80°C (T _J = 175°C)	I _C	42	A
Pulsed Collector Current (T _J = 175°C)	I _{Cpulse}	126	A
Maximum Power Dissipation (T _J = 175°C)	P _{tot}	146	W
Minimum Operating Junction Temperature	T _{JMIN}	-40	°C
Maximum Operating Junction Temperature	T _{JMAX}	175	°C

THERMAL PROPERTIES

Storage Temperature range	T _{stg}	-40 to 150	°C
---------------------------	------------------	------------	----

INSULATION PROPERTIES

Isolation Test Voltage, t = 1 sec, 60 Hz	V _{is}	3000	V _{RMS}
Creepage Distance		12.7	mm

Stresses exceeding those listed in the Maximum Ratings table may damage the device. If any of these limits are exceeded, device functionality should not be assumed, damage may occur and reliability may be affected.

1. Refer to ELECTRICAL CHARACTERISTICS, RECOMMENDED OPERATING RANGES and/or APPLICATION INFORMATION for Safe Operating parameters.

RECOMMENDED OPERATING CONDITIONS

Rating	Symbol	Min	Max	Unit
Module Operating Junction Temperature	T _J	-40	150	°C

Functional operation above the stresses listed in the Recommended Operating Ranges is not implied. Extended exposure to stresses beyond the Recommended Operating Ranges limits may affect device reliability.

NXH40T120L3Q1

ELECTRICAL CHARACTERISTICS (T_J = 25°C Unless Otherwise Noted)

Parameter	Test Conditions	Symbol	Min.	Typ.	Max.	Unit	
IGBT CHARACTERISTICS (Q1, Q4, Q5, Q8, Q9, Q12)							
Collector–Emitter Cutoff Current	V _{GE} = 0 V, V _{CE} = 1200 V	ICES	–	–	400	μA	
Collector–Emitter Saturation Voltage	V _{GE} = 15 V, I _C = 40 A, T _J = 25°C	VCE(sat)	–	1.85	2.20	V	
	V _{GE} = 15 V, I _C = 40 A, T _J = 150°C		–	2.25	–		
Gate–Emitter Threshold Voltage	V _{GE} = V _{CE} , I _C = 1.5 mA	VGE(TH)	4.50	–	6.50	V	
Gate Leakage Current	V _{GE} = 20 V, V _{CE} = 0 V	IGES	–	–	800	nA	
Turn–on Delay Time	T _J = 25°C V _{CE} = 350 V, I _C = 28 A, V _{GE} = ±15 V, R _G = 8 Ω	td(on)	–	63	–	ns	
Rise Time		t _r	–	22	–		
Turn–off Delay Time		td(off)	–	199	–		
Fall Time		t _f	–	23	–		
Turn–on Switching Loss per Pulse		E _{on}	–	560	–		μJ
Turn off Switching Loss per Pulse		E _{off}	–	338	–		
Turn–on Delay Time	T _J = 125°C V _{CE} = 350 V, I _C = 28 A, V _{GE} = ±15 V, R _G = 8 Ω	td(on)	–	59	–	ns	
Rise Time		t _r	–	24	–		
Turn–off Delay Time		td(off)	–	225	–		
Fall Time		t _f	–	80	–		
Turn – on Switching Loss per Pulse		E _{on}	–	757	–		μJ
Turn off Switching Loss per Pulse		E _{off}	–	910	–		
Input Capacitance	V _{CE} = 20 V V _{GE} = 0 V, f = 1 MHz	C _{ies}	–	7753	–	pF	
Output Capacitance		C _{oes}	–	227	–		
Reverse Transfer Capacitance		C _{res}	–	127	–		
Total Gate Charge	V _{CE} = 350 V, I _C = 40 A, V _{GE} = ±15 V	Q _g	–	536	–	nC	
Thermal Resistance – chip–to–heatsink	Thermal grease, Thickness ≤ 2.25 Mil, λ = 2.9 W/mK	R _{thJH}	–	1.01	–	°C/W	

DIODE CHARACTERISTICS (D1, D4, D5, D8, D9, D12)

Diode Forward Voltage	I _F = 20 A, T _J = 25°C	V _F	–	2.4	2.7	V
	I _F = 20 A, T _J = 150°C		–	1.7	–	
Reverse Recovery Time	T _J = 25°C V _{CE} = 350 V, I _C = 28 A, V _{GE} = ±15 V, R _G = 16 Ω	t _{rr}	–	43	–	ns
Reverse Recovery Charge		Q _{rr}	–	756	–	μC
Peak Reverse Recovery Current		I _{RRM}	–	35	–	A
Peak Rate of Fall of Recovery Current		di/dt	–	750	–	A/μs
Reverse Recovery Energy		E _{rr}	–	104	–	μJ
Reverse Recovery Time	T _J = 125°C V _{CE} = 350 V, I _C = 28 A, V _{GE} = ±15 V, R _G = 16 Ω	t _{rr}	–	129	–	ns
Reverse Recovery Charge		Q _{rr}	–	2702	–	μC
Peak Reverse Recovery Current		I _{RRM}	–	45	–	A
Peak Rate of Fall of Recovery Current		di/dt	–	407	–	A/μs
Reverse Recovery Energy		E _{rr}	–	428	–	μJ
Thermal Resistance – chip–to–heatsink	Thermal grease, Thickness ≤ 2.25 Mil, λ = 2.9 W/mK	R _{thJH}	–	1.63	–	°C/W

NXH40T120L3Q1

ELECTRICAL CHARACTERISTICS (T_J = 25°C Unless Otherwise Noted) (continued)

Parameter	Test Conditions	Symbol	Min.	Typ.	Max.	Unit	
IGBT CHARACTERISTICS (Q2, Q3, Q6, Q7, Q10, Q11)							
Collector-Emitter Cutoff Current	V _{GE} = 0 V, V _{CE} = 650 V	ICES	–	–	250	μA	
Collector-Emitter Saturation Voltage	V _{GE} = 15 V, I _C = 50 A, T _J = 25°C	VCE(sat)	–	1.50	–	V	
	V _{GE} = 15 V, I _C = 50 A, T _J = 150°C		–	1.53	–		
Gate-Emitter Threshold Voltage	V _{GE} = V _{CE} , I _C = 1.65 mA	V _{GE} (TH)	2.60	4.40	6.40	V	
Gate Leakage Current	V _{GE} = 20 V, V _{CE} = 0 V	IGES	–	–	400	nA	
Turn-on Delay Time	T _J = 25°C V _{CE} = 350 V, I _C = 28 A, V _{GE} = ±15 V, R _G = 16 Ω	td(on)	–	54	–	ns	
Rise Time		t _r	–	15	–		
Turn-off Delay Time		td(off)	–	157	–		
Fall Time		t _f	–	12	–		
Turn-on Switching Loss per Pulse		E _{on}	–	416	–		μJ
Turn off Switching Loss per Pulse		E _{off}	–	321	–		
Turn-on Delay Time	T _J = 125°C V _{CE} = 350 V, I _C = 28 A, V _{GE} = ±15 V, R _G = 16 Ω	td(on)	–	52	–	ns	
Rise Time		t _r	–	16	–		
Turn-off Delay Time		td(off)	–	178	–		
Fall Time		t _f	–	18	–		
Turn – on Switching Loss per Pulse		E _{on}	–	671	–		μJ
Turn off Switching Loss per Pulse		E _{off}	–	444	–		
Input Capacitance	V _{CE} = 20 V V _{GE} = 0 V, f = 1 MHz	C _{ies}	–	3137	–	pF	
Output Capacitance		C _{oes}	–	146	–		
Reverse Transfer Capacitance		C _{res}	–	17	–		
Total Gate Charge	V _{CE} = 350 V, I _C = 40 A, V _{GE} = ±15 V	Q _g	–	180	–	nC	
Thermal Resistance – chip-to-heatsink	Thermal grease, Thickness ≤ 2.25 Mil, λ = 2.9 W/mK	R _{thJH}	–	0.995	–	°C/W	

DIODE CHARACTERISTICS (D2, D3, D6, D7, D10, D11)

Diode Forward Voltage	I _F = 20 A, T _J = 25°C	V _F	–	1.28	–	V
	I _F = 20 A, T _J = 150°C		–	1.18	–	
Combined IGBT + Diode Voltage Drop	I _F = 20 A, T _J = 25°C	V _F	–	3.05	3.4	V
Reverse Recovery Time	T _J = 25°C V _{CE} = 350 V, I _C = 28 A, V _{GE} = ±15 V, R _G = 8 Ω	t _{rr}	–	69	–	ns
Reverse Recovery Charge		Q _{rr}	–	1267	–	μC
Peak Reverse Recovery Current		I _{RRM}	–	41	–	A
Peak Rate of Fall of Recovery Current		di/dt	–	1599	–	A/μs
Reverse Recovery Energy		E _{rr}	–	244	–	μJ
Reverse Recovery Time	T _J = 125°C V _{CE} = 350 V, I _C = 28 A, V _{GE} = ±15 V, R _G = 8 Ω	t _{rr}	–	111	–	ns
Reverse Recovery Charge		Q _{rr}	–	2323	–	μC
Peak Reverse Recovery Current		I _{RRM}	–	40	–	A
Peak Rate of Fall of Recovery Current		di/dt	–	470	–	A/μs
Reverse Recovery Energy		E _{rr}	–	510	–	μJ

NXH40T120L3Q1

ELECTRICAL CHARACTERISTICS (T_J = 25°C Unless Otherwise Noted) (continued)

Parameter	Test Conditions	Symbol	Min.	Typ.	Max.	Unit
THERMISTOR CHARACTERISTICS						
Nominal resistance	T = 25°C	R ₂₅		22		kΩ
Nominal resistance	T = 100°C	R ₁₀₀		1468		Ω
Deviation of R ₂₅		R/R	-5		5	%
Power dissipation		P _D		200		mW
Power dissipation constant				2		mW/K
B-value	B(25/50), tolerance ±3%			3950		K
B-value	B(25/100), tolerance ±3%			3998		K

Product parametric performance is indicated in the Electrical Characteristics for the listed test conditions, unless otherwise noted. Product performance may not be indicated by the Electrical Characteristics if operated under different conditions.

ORDERING INFORMATION

Orderable Part Number	Marking	Package	Shipping
NXH40T120L3Q1PG	NXH40T120L3Q1PG	Q1 3-Phase TNPC – Case 180AS Press-fit Pins (Pb-Free)	21 Units / Blister Tray
NXH40T120L3Q1SG	NXH40T120L3Q1SG	Q1 3-Phase TNPC – Case 180BN Solder Pins (Pb-Free)	21 Units / Blister Tray
NXH40T120L3Q1PTG	NXH40T120L3Q1PTG	Q1 3-Phase TNPC – Case 180AS Press-fit Pins (Pb-Free)	21 Units / Blister Tray

NXH40T120L3Q1

TYPICAL CHARACTERISTICS – HALF BRIDGE IGBT (Q1, Q4, Q5, Q8, Q9, Q12) AND DIODE (D1, D4, D5, D8, D9, D12)

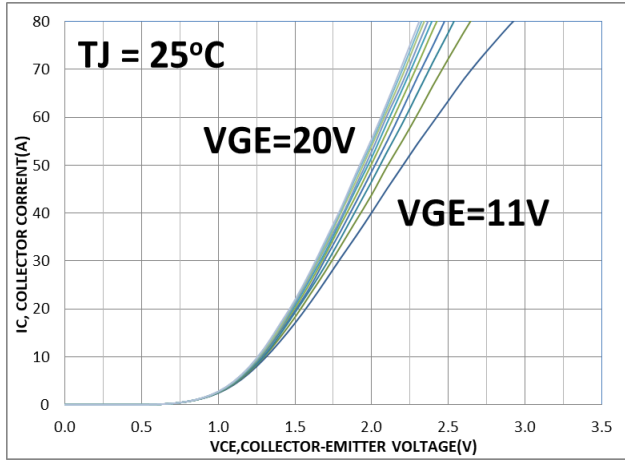

Figure 2. Typical Output Characteristics

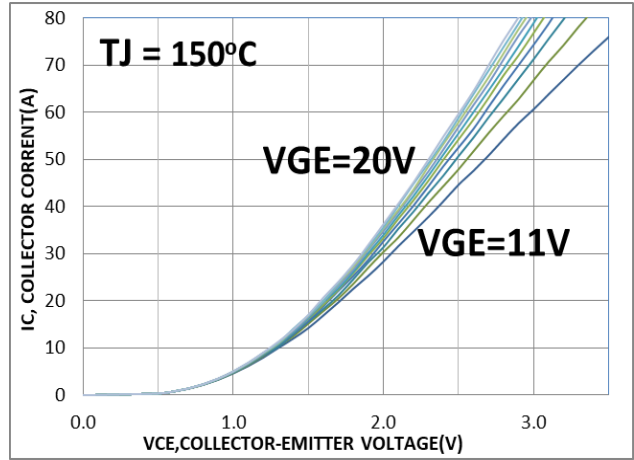

Figure 3. Typical Output Characteristics

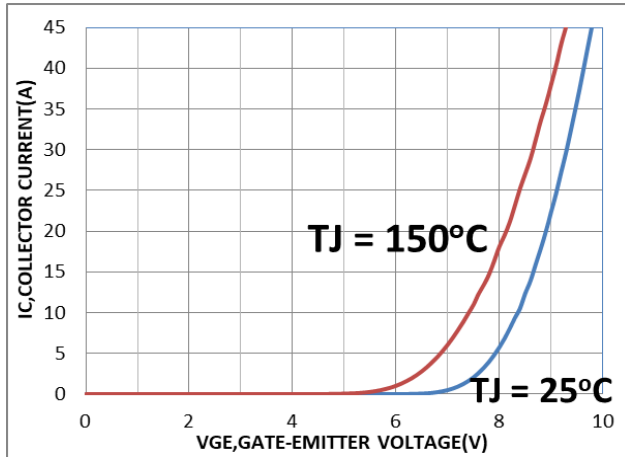

Figure 4. Typical Transfer Characteristics

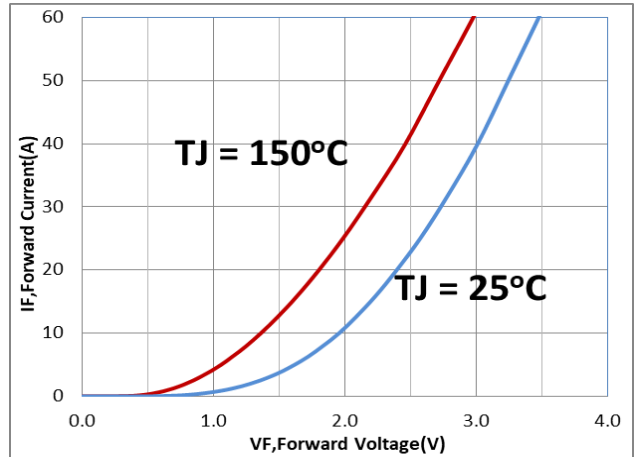

Figure 5. Diode Forward Characteristics

NXH40T120L3Q1

TYPICAL CHARACTERISTICS – HALF BRIDGE IGBT (Q1, Q4, Q5, Q8, Q9, Q12) AND DIODE (D1, D4, D5, D8, D9, D12)

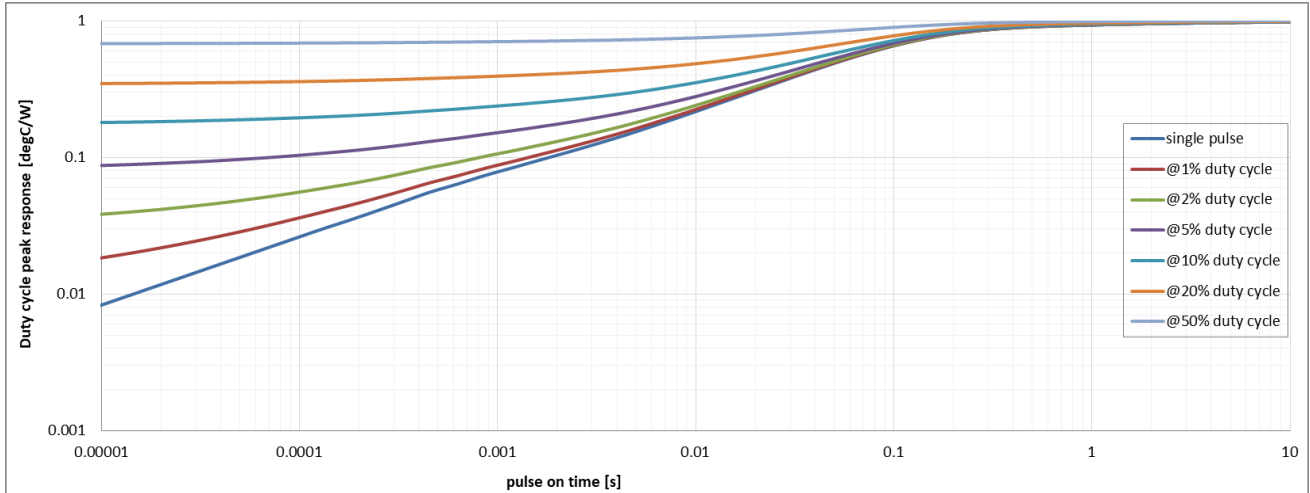

Figure 6. Transient Thermal Impedance (Half Bridge IGBT)

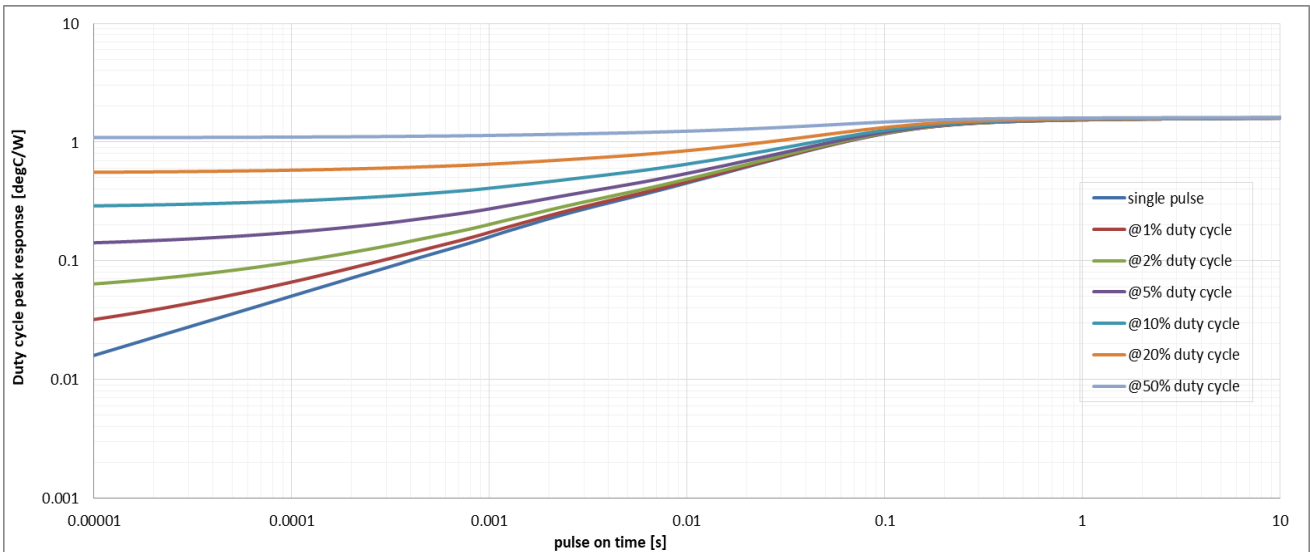

Figure 7. Transient Thermal Impedance (Half Bridge Diode)

NXH40T120L3Q1

TYPICAL CHARACTERISTICS – HALF BRIDGE IGBT (Q1, Q4, Q5, Q8, Q9, Q12) AND DIODE (D1, D4, D5, D8, D9, D12)

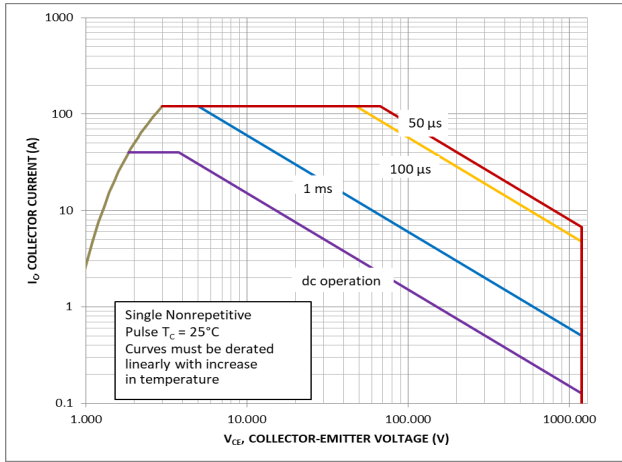

Figure 8. FBSOA

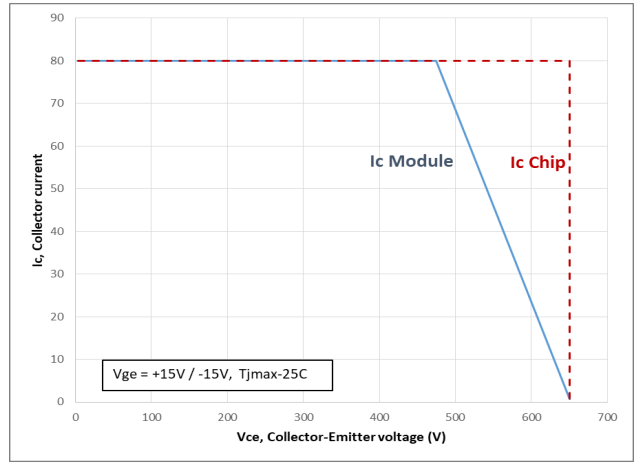

Figure 9. RBSOA

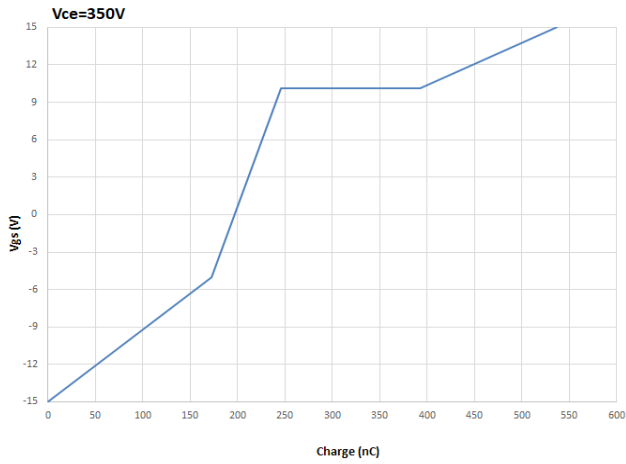

Figure 10. Gate Voltage vs. Gate Charge

NXH40T120L3Q1

TYPICAL CHARACTERISTICS – NP IGBT + DIODE (Q2+D2, Q3+D3, Q6+D6, Q7+D7, Q10+D10, Q11+D11)

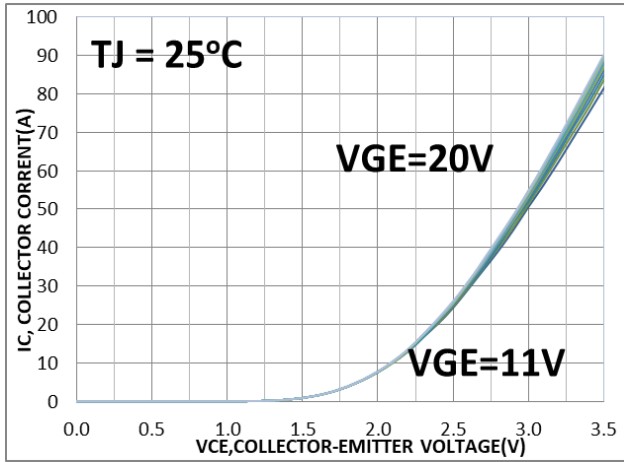

Figure 11. Typical Output Characteristics
(I_C versus V_{DT})

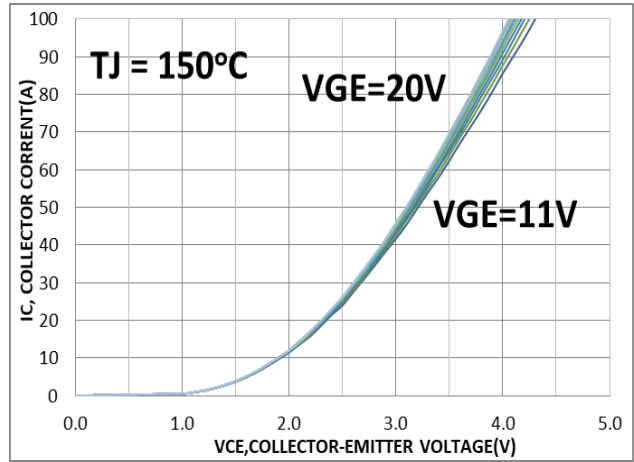

Figure 12. Typical Output Characteristics
(I_C versus V_{DT})

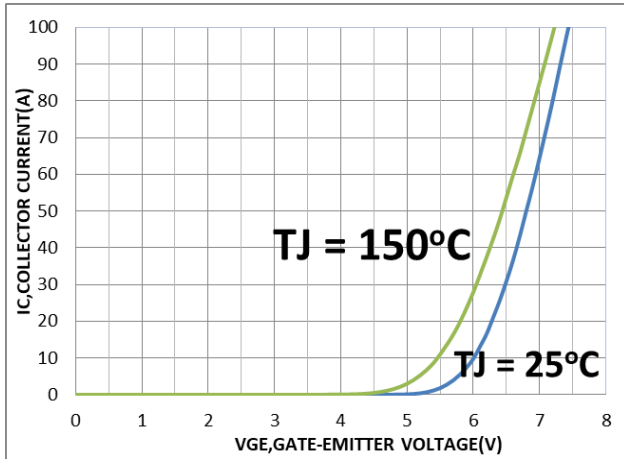

Figure 13. Typical Transfer Characteristics

NXH40T120L3Q1

TYPICAL CHARACTERISTICS – NP IGBT + DIODE (Q2+D2, Q3+D3, Q6+D6, Q7+D7, Q10+D10, Q11+D11)

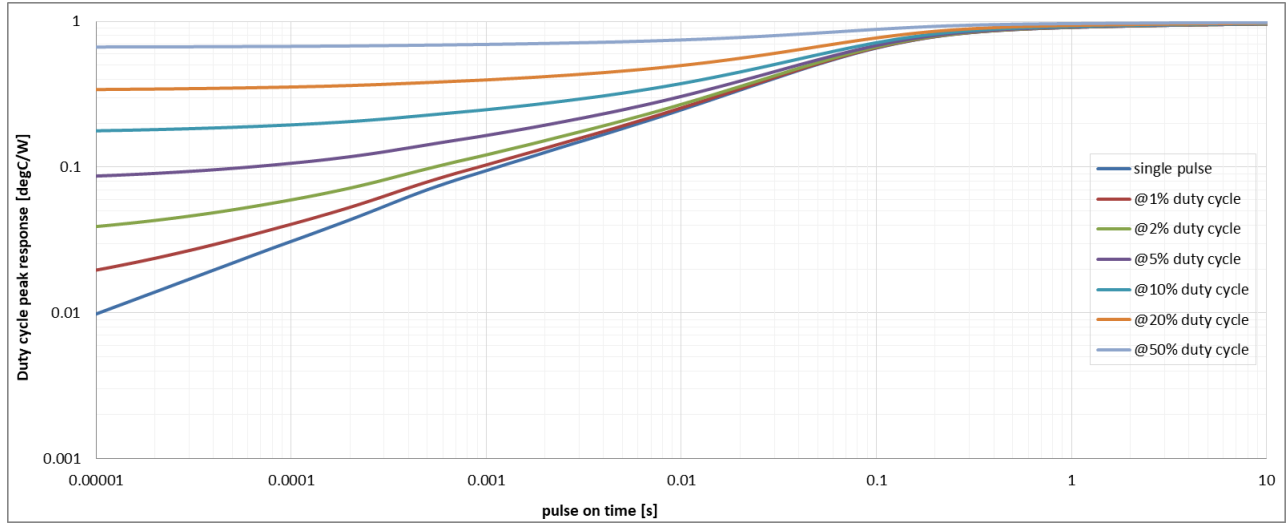

Figure 14. Transient Thermal Impedance (Neutral Point IGBT + Diode)

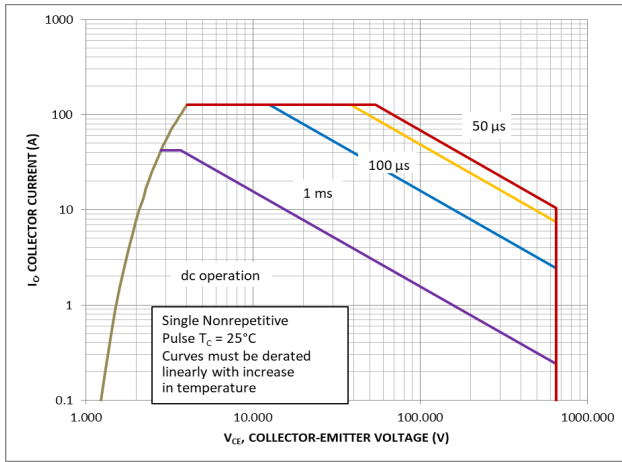

Figure 15. FBSOA (NP IGBT + Diode)

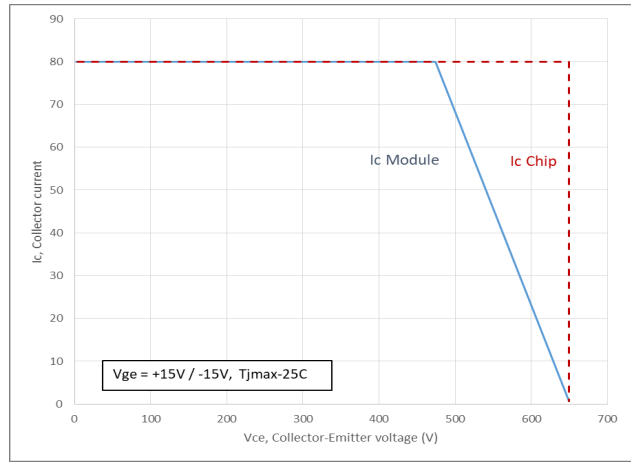

Figure 16. RBSOA (NP IGBT + Diode)

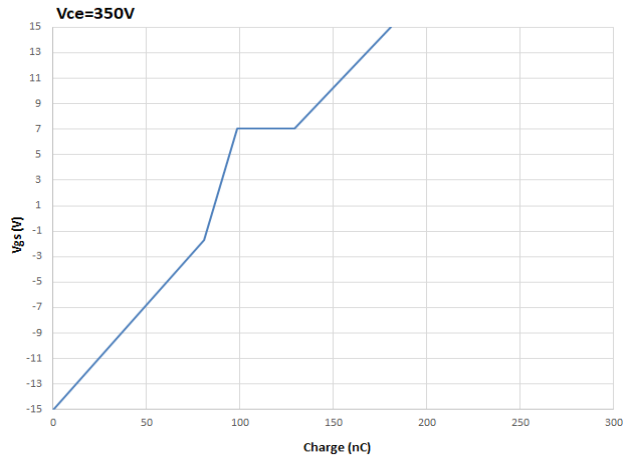

Figure 17. Gate Voltage vs. Gate Charge

NXH40T120L3Q1

TYPICAL CHARACTERISTICS – HALF BRIDGE IGBT COMMUTATES NEUTRAL POINT DIODE

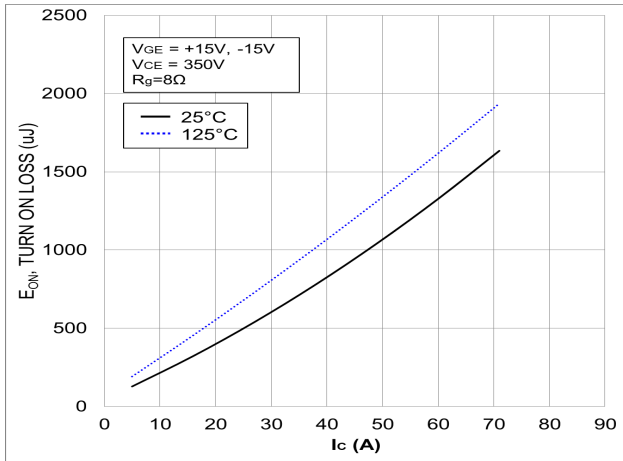

Figure 18. Typical Switching Loss E_{ON} vs. I_C

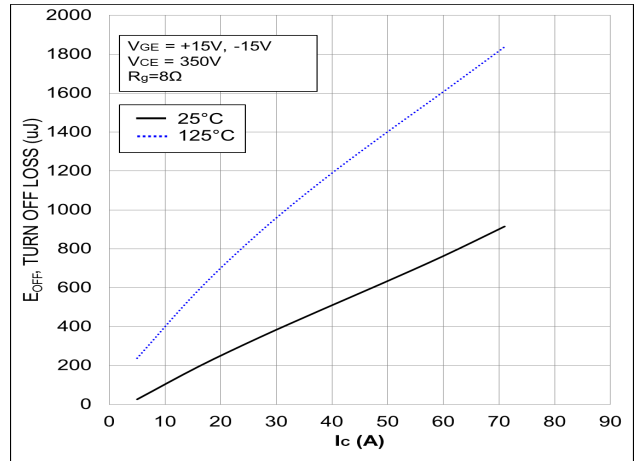

Figure 19. Typical Switching Loss E_{OFF} vs. I_C

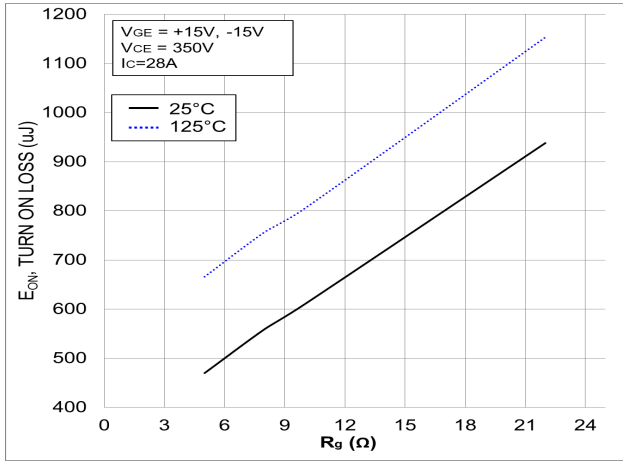

Figure 20. Typical Switching Loss E_{ON} vs. R_g

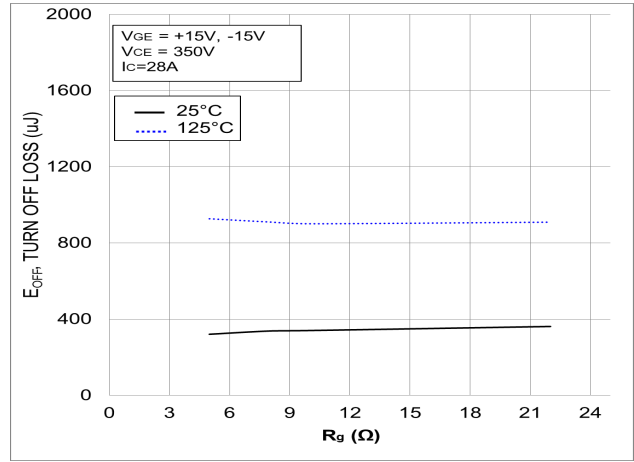

Figure 21. Typical Switching Loss E_{OFF} vs. R_g

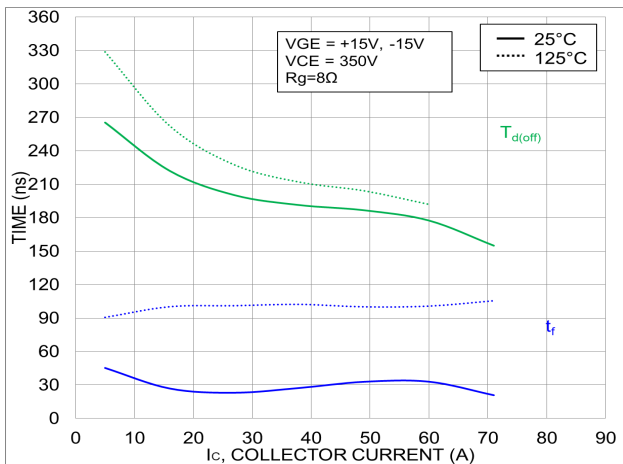

Figure 22. Typical Switching Time T_{DOFF} vs. I_C

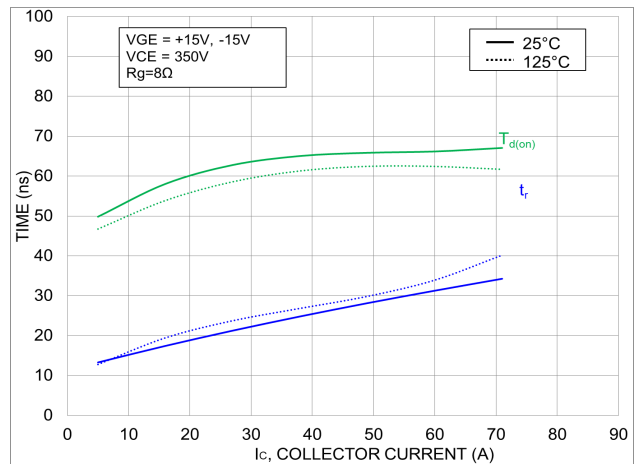

Figure 23. Typical Switching Time T_{DON} vs. I_C

NXH40T120L3Q1

TYPICAL CHARACTERISTICS – HALF BRIDGE IGBT COMMUTATES NEUTRAL POINT DIODE

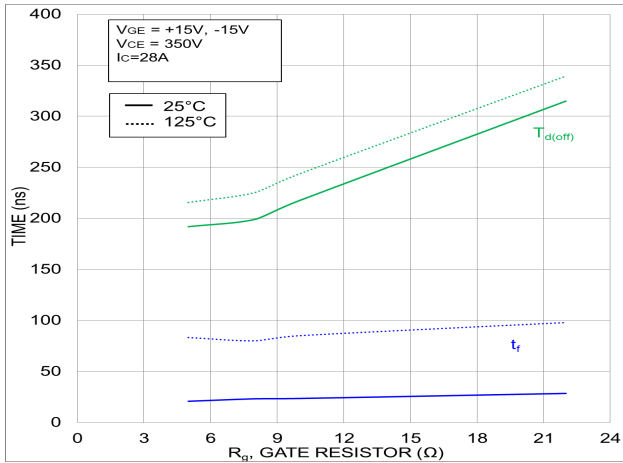

Figure 24. Typical Switching Time T_{DOFF} vs. R_G

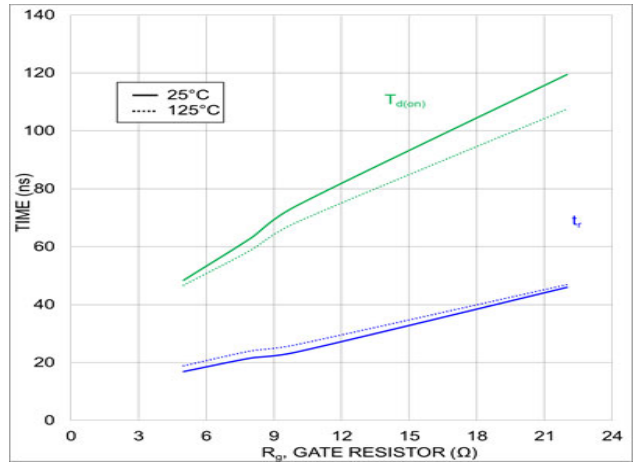

Figure 25. Typical Switching Time T_{DON} vs. R_G

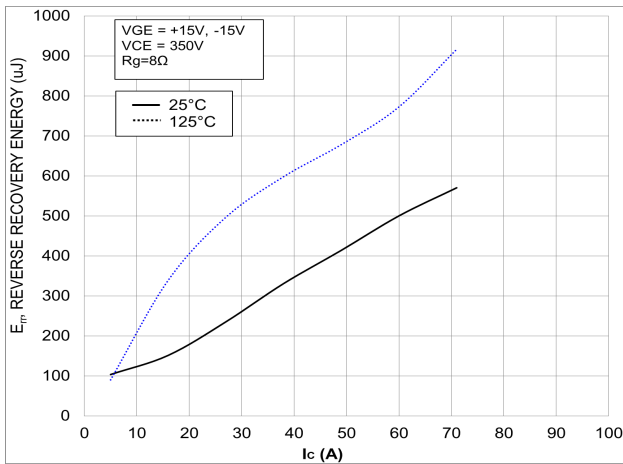

Figure 26. Typical Reverse Recovery Energy Loss vs. I_C

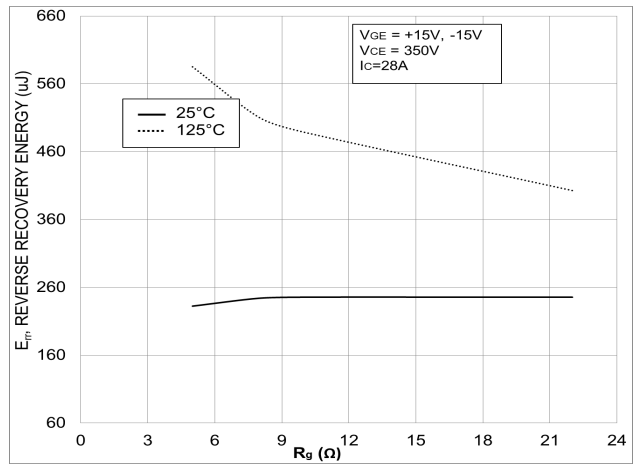

Figure 27. Typical Reverse Recovery Energy Loss vs. R_G

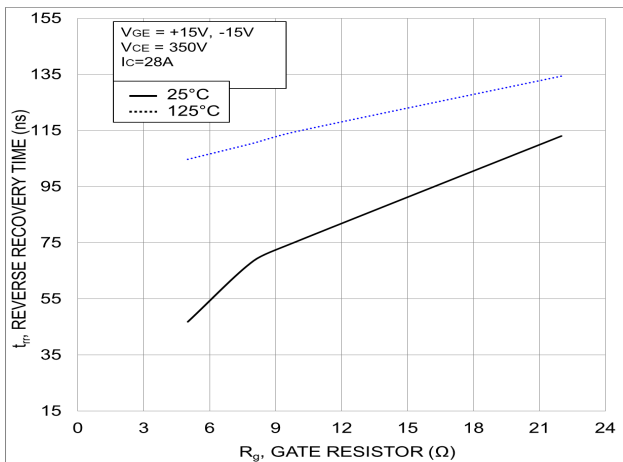

Figure 28. Typical Reverse Recovery Time vs. R_G

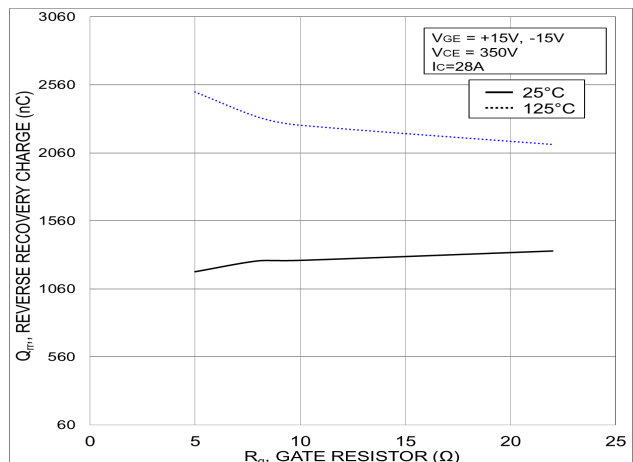

Figure 29. Typical Reverse Recovery Charge vs. R_G

TYPICAL CHARACTERISTICS – HALF BRIDGE IGBT COMMUTATES NEUTRAL POINT DIODE

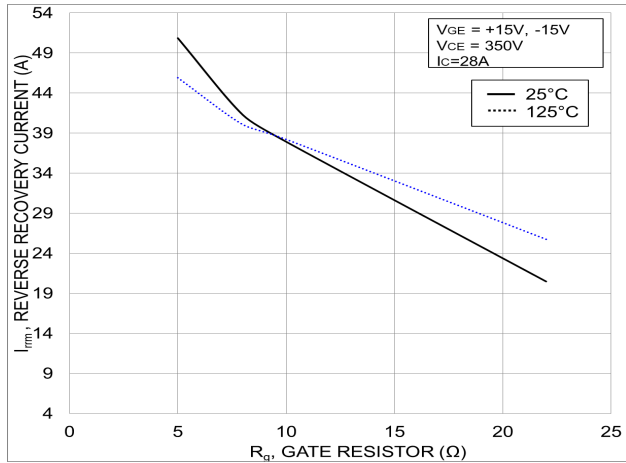

Figure 30. Typical Reverse Recovery Peak Current vs. R_G

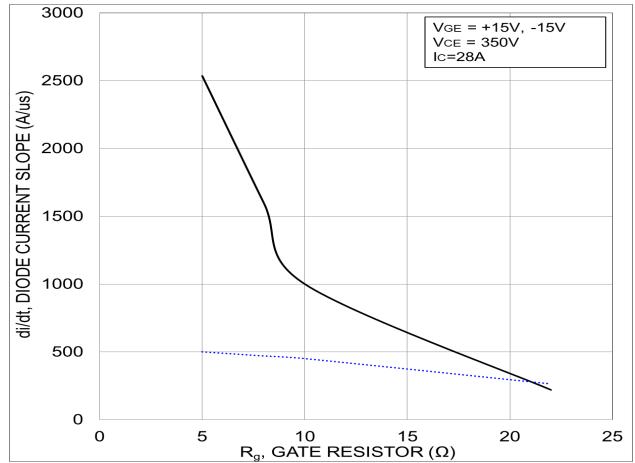

Figure 31. Typical di/dt vs. R_G

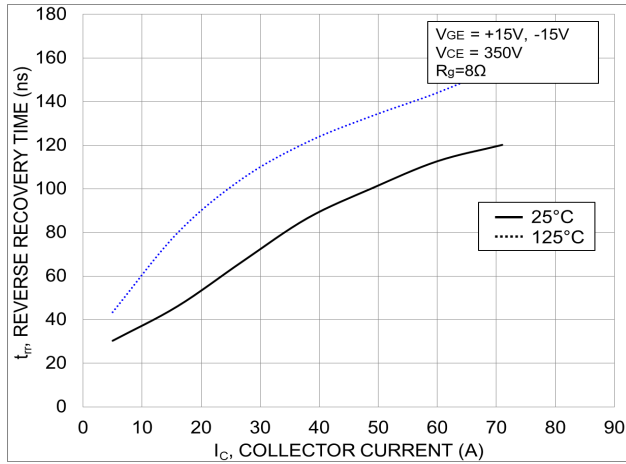

Figure 32. Typical Reverse Recovery Time vs. I_C

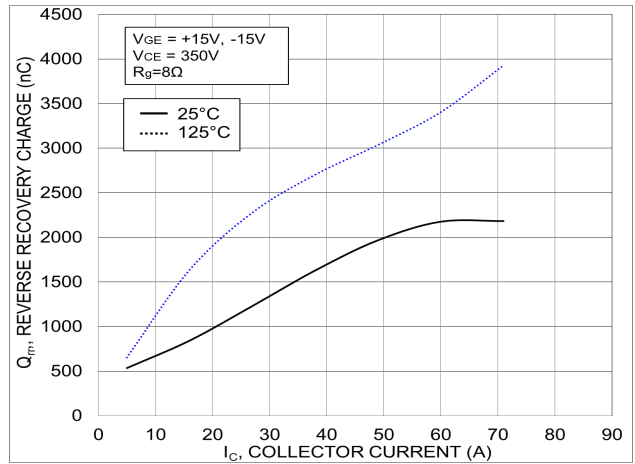

Figure 33. Typical Reverse Recovery Charge vs. I_C

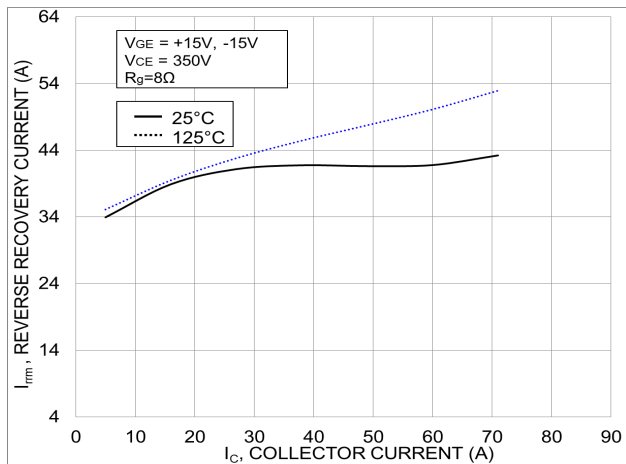

Figure 34. Typical Reverse Recovery Current vs. I_C

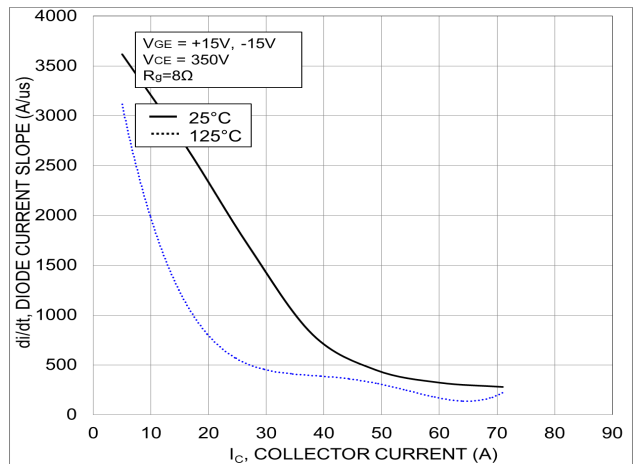

Figure 35. Typical di/dt Current Slope vs. I_C

NXH40T120L3Q1

TYPICAL CHARACTERISTICS – NEUTRAL POINT IGBT COMMUTATES HALF BRIDGE DIODE

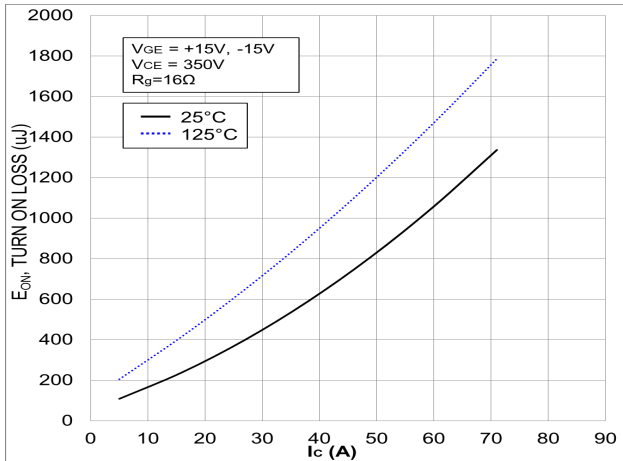

Figure 36. Typical Turn ON Loss vs. I_c

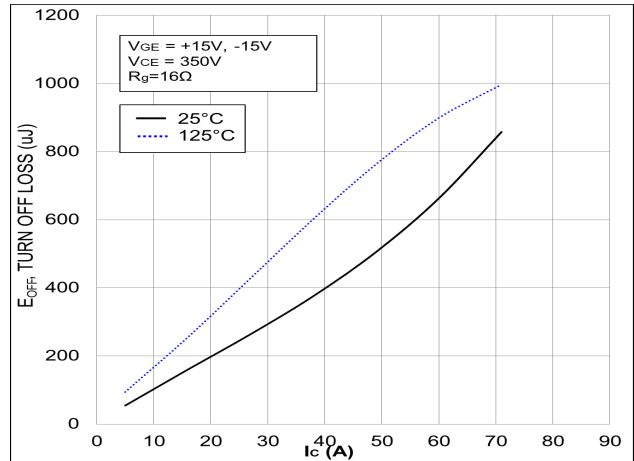

Figure 37. Typical Turn OFF Loss vs. I_c

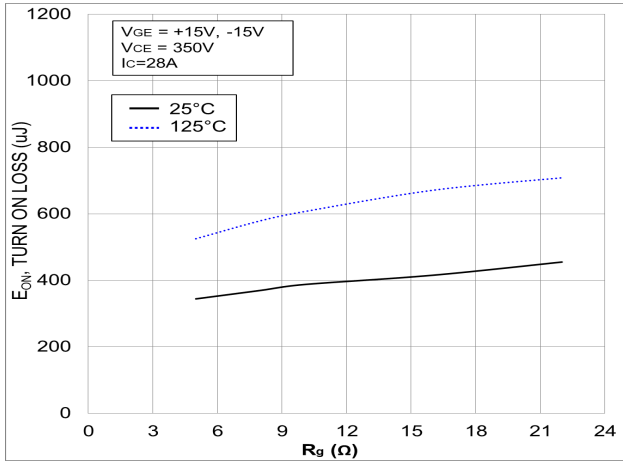

Figure 38. Typical Turn ON Loss vs. R_g

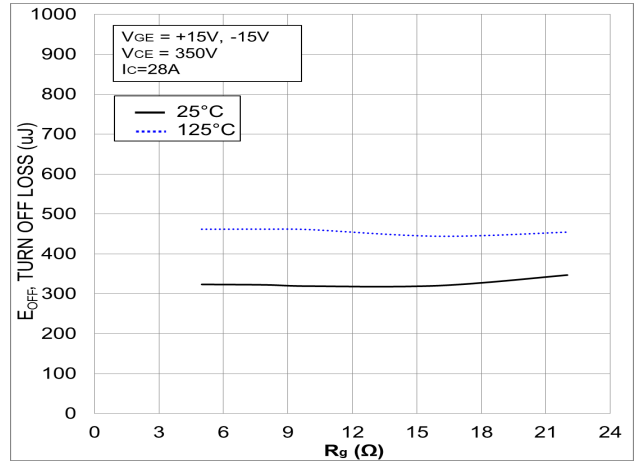

Figure 39. Typical Turn OFF Loss vs. R_g

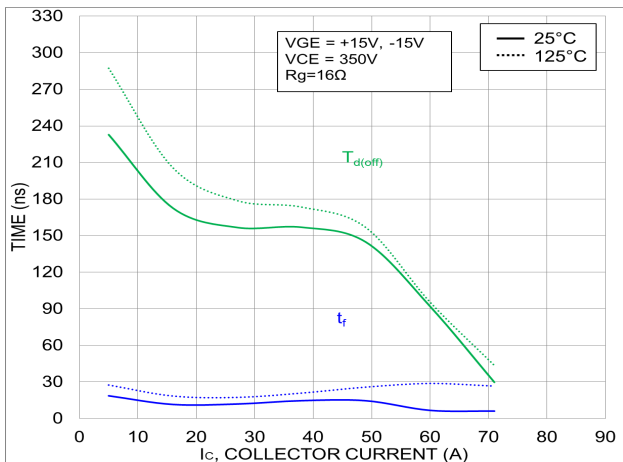

Figure 40. Typical Turn-Off Switching Time vs. I_c

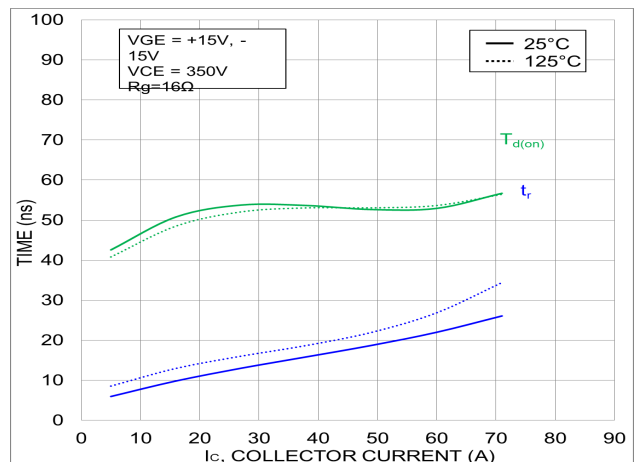

Figure 41. Typical Turn-On Switching Time vs. I_c

TYPICAL CHARACTERISTICS – NEUTRAL POINT IGBT COMMUTATES HALF BRIDGE DIODE

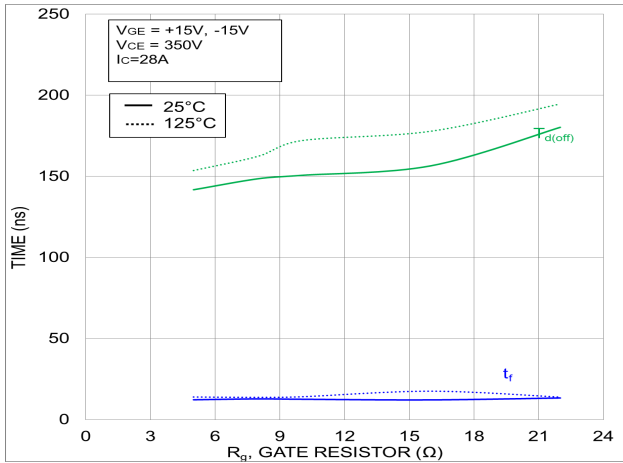

Figure 42. Typical Turn-Off Switching Time vs. R_G

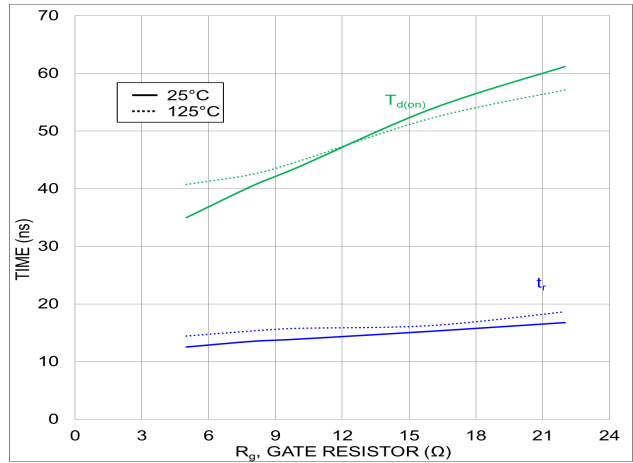

Figure 43. Typical Turn-On Switching Time vs. R_G

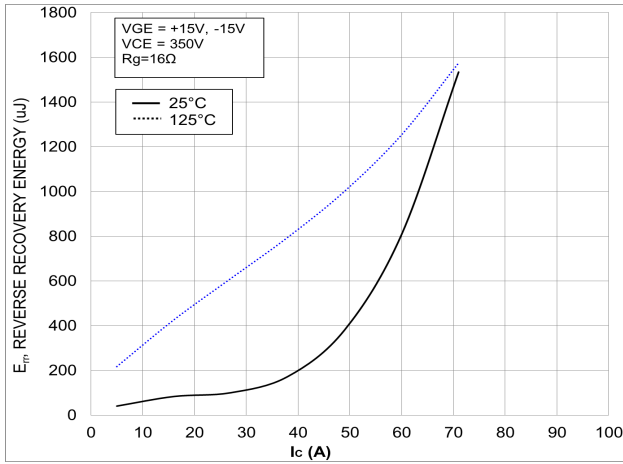

Figure 44. Typical Reverse Recovery Energy Loss vs. I_C

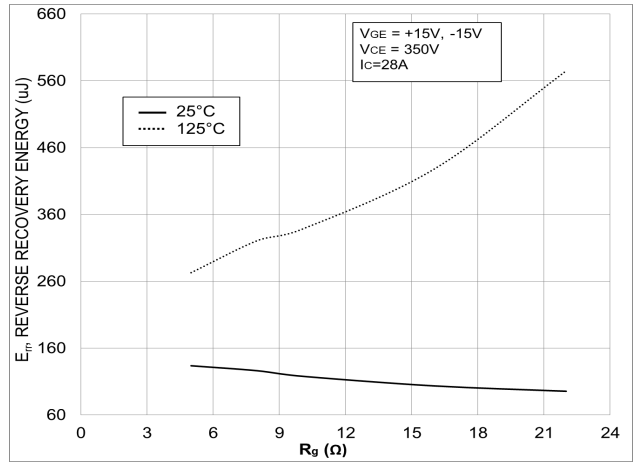

Figure 45. Typical Reverse Recovery Energy Loss vs. R_G

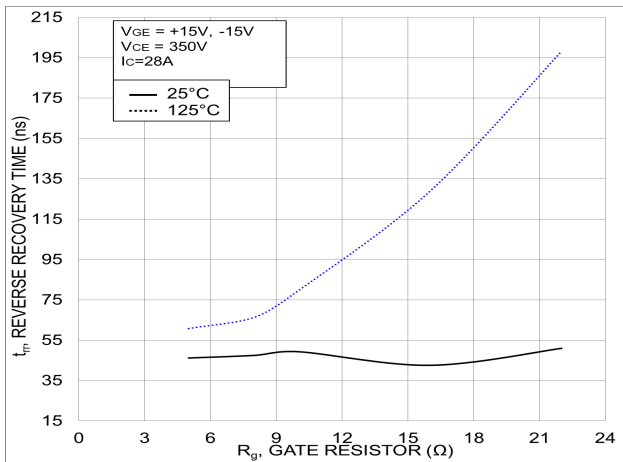

Figure 46. Typical Reverse Recovery Time vs. R_G

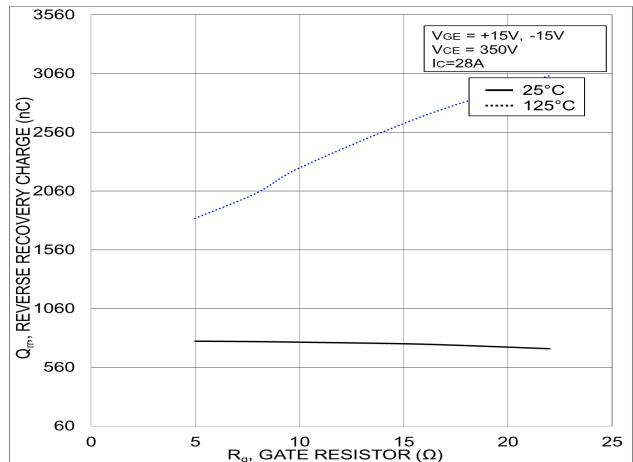

Figure 47. Typical Reverse Recovery Charge vs. R_G

NXH40T120L3Q1

TYPICAL CHARACTERISTICS – NEUTRAL POINT IGBT COMMUTATES HALF BRIDGE DIODE

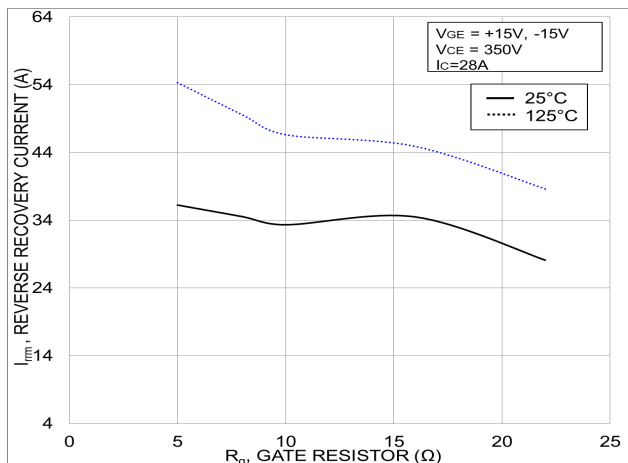

Figure 48. Typical Reverse Recovery Peak Current vs. R_G

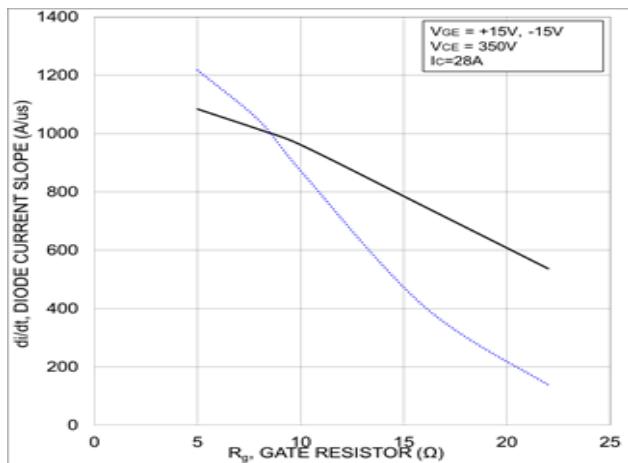

Figure 49. Typical di/dt vs. R_G

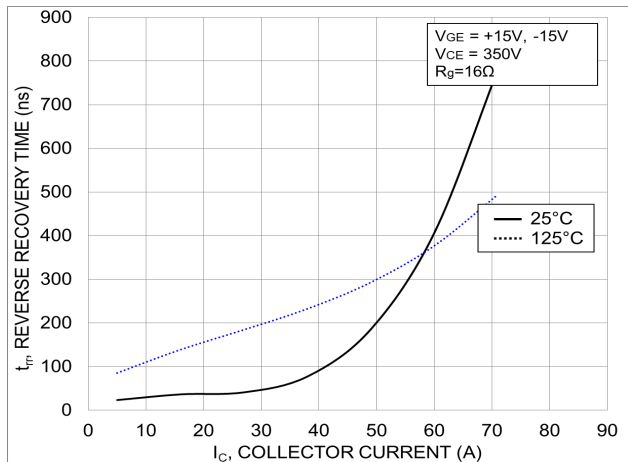

Figure 50. Typical Reverse Recovery Time vs. I_C

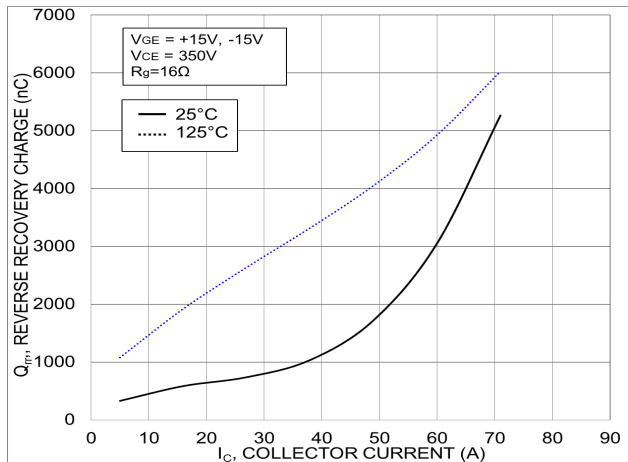

Figure 51. Typical Reverse Recovery Charge vs. I_C

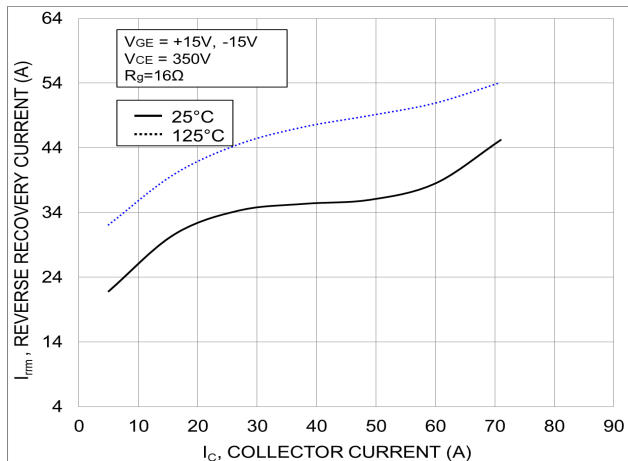

Figure 52. Typical Reverse Recovery Current vs. I_C

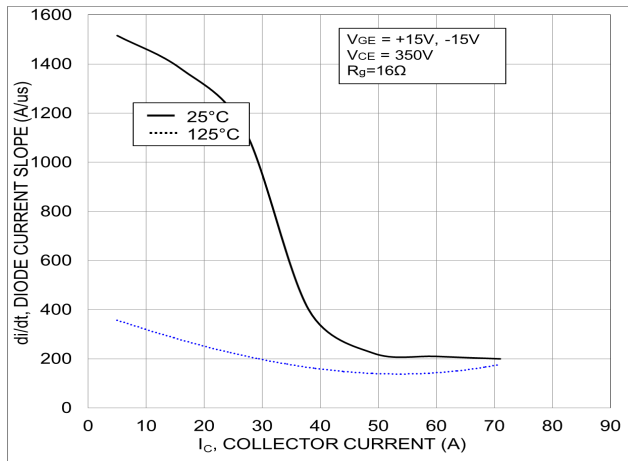

Figure 53. Typical di/dt Current Slope vs. I_C

MECHANICAL CASE OUTLINE PACKAGE DIMENSIONS

ON Semiconductor®



PIM44, 71x37.4
CASE 180AS
ISSUE O

DATE 25 JUN 2018

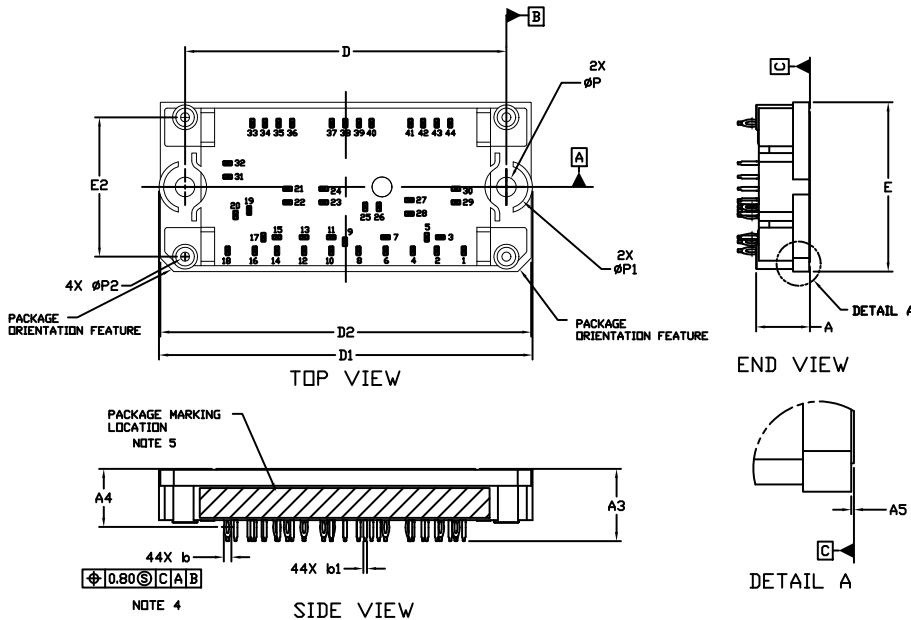

PIN	PIN POSITION		PIN	PIN POSITION	
	X	Y		X	Y
1	26.10	14.10	23	-4.85	3.40
2	20.10	14.10	24	-4.85	0.40
3	20.90	11.10	25	4.30	4.40
4	14.80	14.10	26	7.30	4.40
5	17.90	11.10	27	14.05	2.90
6	8.80	14.10	28	14.05	5.90
7	8.80	11.10	29	24.35	3.40
8	2.80	14.10	30	24.35	0.40
9	-0.20	12.10	31	-26.10	-2.25
10	-3.20	14.10	32	-26.10	-5.25
11	-3.20	11.10	33	-20.65	-14.10
12	-9.20	14.10	34	-17.85	-14.10
13	-9.20	11.10	35	-14.85	-14.10
14	-15.20	14.10	36	-11.85	-14.10
15	-15.20	11.10	37	-3.10	-14.10
16	-20.10	14.10	38	-0.10	-14.10
17	-18.20	11.10	39	2.90	-14.10
18	-26.10	14.10	40	5.70	-14.10
19	-21.35	5.20	41	14.30	-14.10
20	-24.35	6.20	42	17.10	-14.10
21	-12.85	0.40	43	20.10	-14.10
22	-12.85	3.40	44	23.10	-14.10

NOTE 4

PIN	PIN POSITION		PIN	PIN POSITION	
	X	Y		X	Y
1	26.10	-14.10	23	-4.85	-3.40
2	20.10	-14.10	24	-4.85	-0.40
3	20.90	-11.10	25	4.30	-4.40
4	14.80	-14.10	26	7.30	-4.40
5	17.90	-11.10	27	14.05	-2.90
6	8.80	-14.10	28	14.05	-5.90
7	8.80	-11.10	29	24.35	-3.40
8	2.80	-14.10	30	24.35	-0.40
9	-0.20	-12.10	31	-26.10	2.25
10	-3.20	-14.10	32	-26.10	5.25
11	-3.20	-11.10	33	-20.65	14.10
12	-9.20	-14.10	34	-17.85	14.10
13	-9.20	-11.10	35	-14.85	14.10
14	-15.20	-14.10	36	-11.85	14.10
15	-15.20	-11.10	37	-3.10	14.10
16	-20.10	-14.10	38	-0.10	14.10
17	-18.20	-11.10	39	2.90	14.10
18	-26.10	-14.10	40	5.70	14.10
19	-21.35	-5.20	41	14.30	14.10
20	-24.35	-6.20	42	17.10	14.10
21	-12.85	-0.40	43	20.10	14.10
22	-12.85	-3.40	44	23.10	14.10

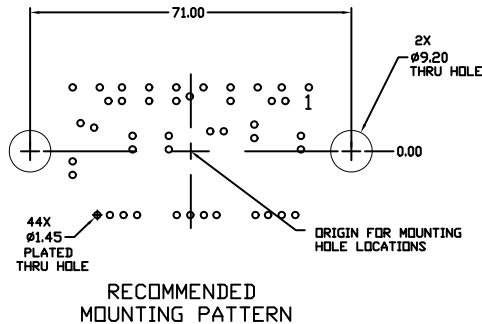

DIM	MILLIMETERS		
	MIN.	NDM.	MAX.
A	11.50	12.00	12.50
A3	15.50	16.00	16.50
A4	12.83 BSC		
A5	0.10	0.20	0.30
b	1.61	1.66	1.71
b1	0.75	0.80	0.85
D	70.50	71.00	71.50
D1	82.00	82.50	83.00
D2	81.50	82.00	82.50
E	36.90	37.40	37.90
E2	30.30	30.80	31.30
P	4.10	4.30	4.50
P1	9.30	9.50	9.70
P2	1.80	2.00	2.20

NOTES:

- DIMENSIONING AND TOLERANCING PER ASME Y14.5M, 2009.
- CONTROLLING DIMENSION: MILLIMETERS
- DIMENSIONS b AND b1 APPLY TO THE PLATED TERMINALS AND ARE MEASURED AT DIMENSION A4.
- POSITION OF THE CENTER OF THE TERMINALS IS DETERMINED FROM DATUM B THE CENTER OF DIMENSION D, X DIRECTION, AND FROM DATUM A, Y DIRECTION. POSITIONAL TOLERANCE, AS NOTED IN DRAWING, APPLIES TO EACH TERMINAL IN BOTH DIRECTIONS.
- PACKAGE MARKING IS LOCATED AS SHOWN ON THE SIDE OPPOSITE THE PACKAGE ORIENTATION FEATURES.

DOCUMENT NUMBER:	98AON92314G	Electronic versions are uncontrolled except when accessed directly from the Document Repository. Printed versions are uncontrolled except when stamped "CONTROLLED COPY" in red.
DESCRIPTION:	PIM44, 71x37.4	PAGE 1 OF 2

ON Semiconductor and are trademarks of Semiconductor Components Industries, LLC dba ON Semiconductor or its subsidiaries in the United States and/or other countries. ON Semiconductor reserves the right to make changes without further notice to any products herein. ON Semiconductor makes no warranty, representation or guarantee regarding the suitability of its products for any particular purpose, nor does ON Semiconductor assume any liability arising out of the application or use of any product or circuit, and specifically disclaims any and all liability, including without limitation special, consequential or incidental damages. ON Semiconductor does not convey any license under its patent rights nor the rights of others.

PIM44, 71x37.4
CASE 180AS
ISSUE O

DATE 15 JUN 2018

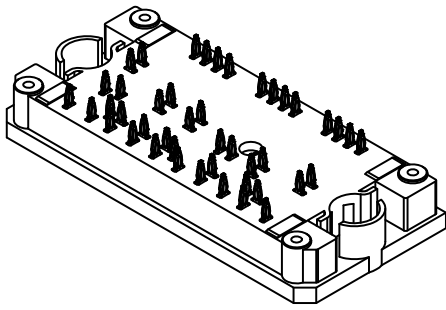

**GENERIC
MARKING DIAGRAM***

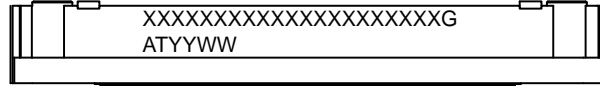

XXXXX = Specific Device Code
G = Pb-Free Package
AT = Assembly & Test Site Code
YYWW = Year and Work Week Code

*This information is generic. Please refer to device data sheet for actual part marking. Pb-Free indicator, "G" or microdot "•", may or may not be present. Some products may not follow the Generic Marking.

DOCUMENT NUMBER:	98AON92314G	Electronic versions are uncontrolled except when accessed directly from the Document Repository. Printed versions are uncontrolled except when stamped "CONTROLLED COPY" in red.
DESCRIPTION:	PIM44, 71x37.4	PAGE 2 OF 2

ON Semiconductor and  are trademarks of Semiconductor Components Industries, LLC dba ON Semiconductor or its subsidiaries in the United States and/or other countries. ON Semiconductor reserves the right to make changes without further notice to any products herein. ON Semiconductor makes no warranty, representation or guarantee regarding the suitability of its products for any particular purpose, nor does ON Semiconductor assume any liability arising out of the application or use of any product or circuit, and specifically disclaims any and all liability, including without limitation special, consequential or incidental damages. ON Semiconductor does not convey any license under its patent rights nor the rights of others.

www.onsemi.com

MECHANICAL CASE OUTLINE

PACKAGE DIMENSIONS

ON Semiconductor®



PIM44, 71x37.4 (SOLDER PINS) CASE 180BN ISSUE 0

DATE 08 OCT 2019

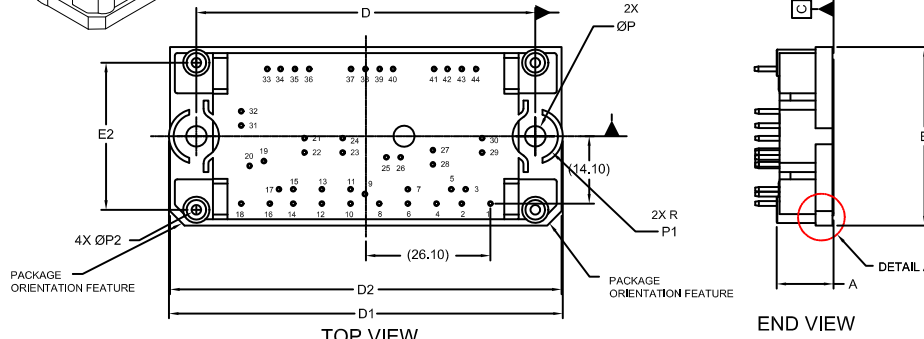
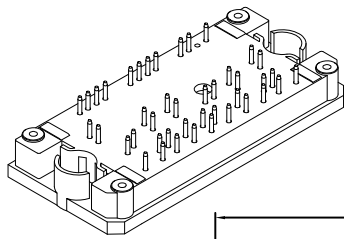

DIM	MILLIMETERS		
	MIN.	NOM.	MAX.
A	11.50	12.00	12.50
A2	10.90	11.40	11.90
A3	15.90	16.40	16.90
A5	0.00	0.30	0.60
b	0.90	1.00	1.10
D	70.50	71.00	71.50
D1	82.00	82.50	83.00
D2	81.50	82.00	82.50
E	36.90	37.40	37.90
E2	30.30	30.80	31.30
P	4.30	4.40	4.50
P1	4.55	4.75	4.95
P2	2.00 REF		

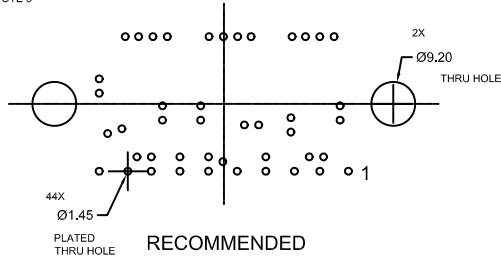
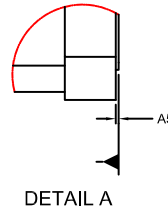
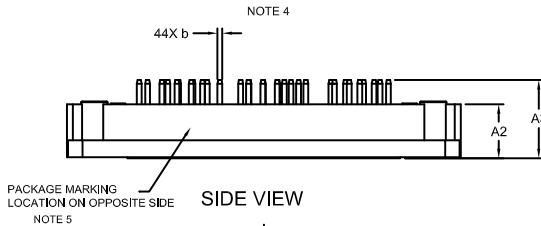

*FOR ADDITIONAL INFORMATION ON OUR Pb-FREE STRATEGY AND SOLDERING DETAILS, PLEASE DOWNLOAD THE ON SEMICONDUCTOR SOLDERING AND MOUNTING TECHNIQUES REFERENCE MANUAL, SOLDERRMD.

GENERIC MARKING DIAGRAM*

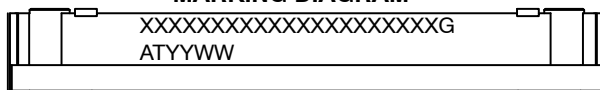

XXXXX = Specific Device Code
G = Pb-Free Package
AT = Assembly & Test Site Code
YYWW = Year and Work Week Code

*This information is generic. Please refer to device data sheet for actual part marking. Pb-Free indicator, "G" or microdot "▪", may or may not be present. Some products may not follow the Generic Marking.

NOTE 4

PIN	PIN POSITION		PIN	PIN POSITION	
	X	Y		X	Y
1	26.10	-14.10	23	-4.85	-3.40
2	20.10	-14.10	24	-4.85	-0.40
3	20.90	-11.10	25	4.30	-4.40
4	14.80	-14.10	26	7.30	-4.40
5	17.90	-11.10	27	14.05	-2.90
6	8.80	-14.10	28	14.05	-5.90
7	8.80	-11.10	29	24.35	-3.40
8	2.80	-14.10	30	24.35	-0.40
9	-0.20	-12.10	31	-26.10	2.25
10	-3.20	-14.10	32	-26.10	5.25
11	-3.20	-11.10	33	-20.65	14.10
12	-9.20	-14.10	34	-17.85	14.10
13	-9.20	-11.10	35	-14.85	14.10
14	-15.20	-14.10	36	-11.85	14.10
15	-15.20	-11.10	37	-3.10	14.10
16	-20.10	-14.10	38	-0.10	14.10
17	-18.20	-11.10	39	2.90	14.10
18	-26.10	-14.10	40	5.70	14.10
19	-21.35	-5.20	41	14.30	14.10
20	-24.35	-6.20	42	17.10	14.10
21	-12.85	-0.40	43	20.10	14.10
22	-12.85	-3.40	44	23.10	14.10

NOTES:

- DIMENSIONING AND TOLERANCING PER ASME Y14.5M, 2009.
- CONTROLLING DIMENSION: MILLIMETERS
- DIMENSIONS b APPLIES TO THE PLATED TERMINALS AND IS MEASURED BETWEEN 1.00 AND 3.00 FROM THE TERMINAL TIP.
- POSITION OF THE CENTER OF THE TERMINALS AND MOUNTING HOLES IS DETERMINED FROM DATUM B THE CENTER OF DIMENSION D, X DIRECTION, AND FROM DATUM A, Y DIRECTION. POSITIONAL TOLERANCE, AS NOTED IN THE DRAWING, APPLIES TO EACH TERMINAL IN BOTH DIRECTIONS.
- PACKAGE MARKING IS LOCATED AS SHOWN ON THE SIDE OPPOSITE THE PACKAGE ORIENTATION FEATURES.

DOCUMENT NUMBER:	98AON12615H	Electronic versions are uncontrolled except when accessed directly from the Document Repository. Printed versions are uncontrolled except when stamped "CONTROLLED COPY" in red.
DESCRIPTION:	PIM44, 71x37.4 (SOLDER PINS)	PAGE 1 OF 2

ON Semiconductor and ON are trademarks of Semiconductor Components Industries, LLC dba ON Semiconductor or its subsidiaries in the United States and/or other countries. ON Semiconductor reserves the right to make changes without further notice to any products herein. ON Semiconductor makes no warranty, representation or guarantee regarding the suitability of its products for any particular purpose, nor does ON Semiconductor assume any liability arising out of the application or use of any product or circuit, and specifically disclaims any and all liability, including without limitation special, consequential or incidental damages. ON Semiconductor does not convey any license under its patent rights nor the rights of others.

onsemi, **Onsemi**, and other names, marks, and brands are registered and/or common law trademarks of Semiconductor Components Industries, LLC dba "**onsemi**" or its affiliates and/or subsidiaries in the United States and/or other countries. **onsemi** owns the rights to a number of patents, trademarks, copyrights, trade secrets, and other intellectual property. A listing of **onsemi**'s product/patent coverage may be accessed at www.onsemi.com/site/pdf/Patent-Marking.pdf. **onsemi** reserves the right to make changes at any time to any products or information herein, without notice. The information herein is provided "as-is" and **onsemi** makes no warranty, representation or guarantee regarding the accuracy of the information, product features, availability, functionality, or suitability of its products for any particular purpose, nor does **onsemi** assume any liability arising out of the application or use of any product or circuit, and specifically disclaims any and all liability, including without limitation special, consequential or incidental damages. Buyer is responsible for its products and applications using **onsemi** products, including compliance with all laws, regulations and safety requirements or standards, regardless of any support or applications information provided by **onsemi**. "Typical" parameters which may be provided in **onsemi** data sheets and/or specifications can and do vary in different applications and actual performance may vary over time. All operating parameters, including "Typicals" must be validated for each customer application by customer's technical experts. **onsemi** does not convey any license under any of its intellectual property rights nor the rights of others. **onsemi** products are not designed, intended, or authorized for use as a critical component in life support systems or any FDA Class 3 medical devices or medical devices with a same or similar classification in a foreign jurisdiction or any devices intended for implantation in the human body. Should Buyer purchase or use **onsemi** products for any such unintended or unauthorized application, Buyer shall indemnify and hold **onsemi** and its officers, employees, subsidiaries, affiliates, and distributors harmless against all claims, costs, damages, and expenses, and reasonable attorney fees arising out of, directly or indirectly, any claim of personal injury or death associated with such unintended or unauthorized use, even if such claim alleges that **onsemi** was negligent regarding the design or manufacture of the part. **onsemi** is an Equal Opportunity/Affirmative Action Employer. This literature is subject to all applicable copyright laws and is not for resale in any manner.

ADDITIONAL INFORMATION

TECHNICAL PUBLICATIONS:

Technical Library: www.onsemi.com/design/resources/technical-documentation
onsemi Website: www.onsemi.com

ONLINE SUPPORT: www.onsemi.com/support

For additional information, please contact your local Sales Representative at www.onsemi.com/support/sales

