

Automotive 1200 V, 450 A Dual Side Cooling Half-Bridge Power Module VE-Trac™ Dual NVG450A120L5DSC



AHPM15-CEA
CASE 100DD

Product Description

The NVG450A120L5DSC is a member of the VE-Trac Dual power module family with dual side cooling and compact footprints for Hybrid (HEV) and Electric Vehicle (EV) traction inverter application.

The module consists of two latest 1200 V Ultra Field Stop (UFS) IGBTs in a half-bridge configuration. The chipset utilizes the proven Trench Ultra Field Stop IGBT technology in providing high current density while offering robust short circuit protection and increased blocking voltage. Additionally, UFS IGBT and copacked soft diode deliver a low power loss operation and soft switching simultaneously, which helps to improve overall system efficiency in HEV/EV traction applications.

Features

- Dual-Side Cooling
- Integrated Chip Level Temperature & Current Sensor
- $T_{vj\ max} = 175^{\circ}C$
- Low Stray Inductance
- Low Conduction and Switching Losses
- Automotive Grade
- 4.2 kV Isolated DBC Substrate
- This is a Pb-Free Device

Typical Applications

- Hybrid and Electric Vehicle Traction Inverter
- High Power DC-DC Converter

MARKING DIAGRAM



ZZZ = Assembly Lot Code
AT = Assembly & Test Site Code
Y = Year
WW = Work Week
XXXX = Specific Device Code
NNN = Serial Number

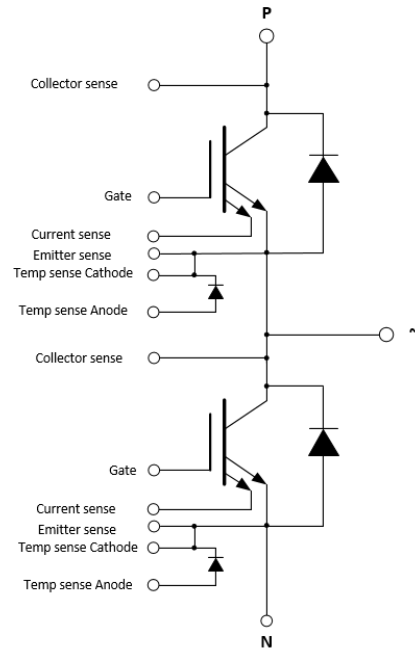

ORDERING INFORMATION

See detailed ordering and shipping information on page 9 of this data sheet.

VE-Trac™ Dual NVG450A120L5DSC

PIN DESCRIPTION

Pin No.	Pin	Description	Pin Arrangement
1	N	Low Side Emitter	
2	P	High Side Collector	
3	H/S COLLECTOR SENSE	High Side Collector Sense	
4	H/S CURRENT SENSE	High Side Current Sense	
5	H/S EMITTER SENSE	High Side Emitter Sense	
6	H/S GATE	High Side Gate	
7	H/S TEMP SENSE (CATHODE)	High Side Temp sense Diode Cathode	
8	H/S TEMP SENSE (ANODE)	High Side Temp sense Diode Anode	
9	~	Phase Output	
10	L/S CURRENT SENSE	Low Side Current Sense	
11	L/S EMITTER SENSE	Low Side Emitter Sense	
12	L/S GATE	Low Side Gate	
13	L/S TEMP SENSE (CATHODE)	Low Side Temp sense Diode Cathode	
14	L/S TEMP SENSE (ANODE)	Low Side Temp sense Diode Anode	
15	L/S COLLECTOR SENSE	Low Side Collector Sense	

DBC Substrate

Al₂O₃ isolated substrate, basic isolation, and copper on both sides

Lead frame

Copper, with tin electro-plating

Flammability Information

All Power Module packaging materials meet UL flammability rating class 94V-0

MODULE CHARACTERISTICS

Symbol	Parameter	Rating	Unit		
T _{vj}	Continuous Operating Junction Temperature Range	-40 to 150	°C		
T _{vj,op}	Continuous Operating Junction Temperature Under Switching Conditions	-40 to 175	°C		
T _{STG}	Storage Temperature Range	-40 to 125	°C		
V _{ISO}	Isolation Voltage, AC, f = 50 Hz, t = 1 s	4200	V		
Creepage	Terminal to Heatsink Terminal to Terminal	6.0	mm		
Clearance	Terminal to Heatsink Terminal to Terminal	3.2	mm		
CTI	Comparative Tracking Index	>600			
		Min.	Typ.	Max.	
L _{sCE}	Stray Inductance	-	-	8	nH
R _{CC'+EE'}	Module Lead Resistance, Terminals - Chip	-	-	0.15	mΩ
G	Module Weight	-	-	72	g
M	M4 Screws for Module Terminals	-	-	2.2	Nm

VE-Trac™ Dual NVG450A120L5DSC

ABSOLUTE MAXIMUM RATINGS ($T_{Vj} = 25^{\circ}\text{C}$, unless otherwise specified)

Symbol	Parameter	Rating	Unit
IGBT			
V_{CES}	Collector to Emitter Voltage	1200	V
V_{GES}	Gate to Emitter Voltage	-15/+20	V
$V_{GES\ transient}$	Gate to Emitter Voltage, Limits under switching conditions	± 20	V
I_{CN}	Implemented Collector Current	450	A
$I_{C\ nom}$	Continuous DC Collector Current, $T_{vjmax} = 175^{\circ}\text{C}$, $T_F = 65^{\circ}\text{C}$, Ref. Heatsink	410 (Note 1)	A
I_{CRM}	Pulsed Collector Current @ $V_{GE} = 15\text{ V}$, $t_p = 1\text{ ms}$	900	A

DIODE

V_{RRM}	Repetitive Peak Reverse Voltage	1200	V
I_{FN}	Implemented Forward Current	450	A
I_F	Continuous Forward Current, $T_{vjmax} = 175^{\circ}\text{C}$, $T_F = 65^{\circ}\text{C}$, Ref. Heatsink	360 (Note 1)	A
I_{FRM}	Repetitive Peak Forward Current, $t_p = 1\text{ ms}$	900	A
I^2t value	$V_R = 0\text{ V}$, $t_p = 10\text{ ms}$, $T_{Vj} = 150^{\circ}\text{C}$ $T_{Vj} = 175^{\circ}\text{C}$	14400 12960	A^2s

Stresses exceeding those listed in the Maximum Ratings table may damage the device. If any of these limits are exceeded, device functionality should not be assumed, damage may occur and reliability may be affected.

1. Verified by characterization, not test.

THERMAL CHARACTERISTICS (Verified by characterization, not test)

Symbol	Parameter	Min.	Typ.	Max.	Unit
IGBT. $R_{th,J-C}$	Effective R_{th} , Junction to Case (Note 2)	-	0.06	0.08	$^{\circ}\text{C}/\text{W}$
IGBT. $R_{th,J-F}$	Effective R_{th} , Junction to Fluid, $\lambda_{TIM} = 6\text{ W/m-K}$, $F = 660\text{ N}$ 10 L/min, 65°C , 50/50 EGW, Ref. Heatsink	-	0.15	-	$^{\circ}\text{C}/\text{W}$
Diode. $R_{th,J-C}$	Effective R_{th} , Junction to Case (Note 2)	-	0.08	0.10	$^{\circ}\text{C}/\text{W}$
Diode. $R_{th,J-F}$	Effective R_{th} , Junction to Fluid, $\lambda_{TIM} = 6\text{ W/m-K}$, $F = 660\text{ N}$ 10 L/min, 65°C , 50/50 EGW, Ref. Heatsink	-	0.21	-	$^{\circ}\text{C}/\text{W}$

2. For the measurement point of case temperature (T_c), DBC discoloration, picker circle print is allowed, please refer to the VE-Trac Dual assembly guide for additional details about acceptable DBC surface finish.

VE-Trac™ Dual NVG450A120L5DSC

CHARACTERISTICS OF IGBT ($T_{vj} = 25^{\circ}\text{C}$, unless otherwise specified)

Parameters		Conditions	Min	Typ	Max	unit
V_{CESAT}	Collector to Emitter Saturation Voltage (Terminal)	$V_{GE} = 15\text{ V}, I_C = 300\text{ A}, T_{vj} = 25^{\circ}\text{C}$	–	1.38	1.6	V
		$T_{vj} = 150^{\circ}\text{C}$	–	1.50	–	
		$T_{vj} = 175^{\circ}\text{C}$	–	1.53	–	
		$V_{GE} = 15\text{ V}, I_C = 450\text{ A}, T_{vj} = 25^{\circ}\text{C}$	–	1.59	–	
		$T_{vj} = 150^{\circ}\text{C}$	–	1.82	–	
		$T_{vj} = 175^{\circ}\text{C}$	–	1.87	–	
I_{CES}	Collector to Emitter Leakage Current	$V_{GE} = 0\text{ V}, V_{CE} = 1200\text{ V}, T_{vj} = 25^{\circ}\text{C}$	–	–	1	mA
		$T_{vj} = 175^{\circ}\text{C}$	–	7	–	
I_{GES}	Gate – Emitter Leakage Current	$V_{CE} = 0\text{ V}, V_{GE} = +20\text{ V}/-15\text{ V}$	–	–	± 400	nA
V_{th}	Threshold Voltage	$V_{CE} = V_{GE}, I_C = 500\text{ mA}$	5.8	6.8	7.6	V
Q_G	Total Gate Charge	$V_{GE} = -8\text{ to }15\text{ V}, V_{CE} = 600\text{ V}$	–	1.45	–	μC
R_{Gint}	Internal Gate Resistance		–	0	–	Ω
C_{ies}	Input Capacitance	$V_{CE} = 30\text{ V}, V_{GE} = 0\text{ V}, f = 1\text{ MHz}$	–	61	–	nF
C_{oes}	Output Capacitance	$V_{CE} = 30\text{ V}, V_{GE} = 0\text{ V}, f = 1\text{ MHz}$	–	1.5	–	nF
C_{res}	Reverse Transfer Capacitance	$V_{CE} = 30\text{ V}, V_{GE} = 0\text{ V}, f = 1\text{ MHz}$	–	0.7	–	nF
$T_{d,on}$	Turn On Delay, Inductive Load	$I_C = 300\text{ A}, V_{CE} = 600\text{ V}, T_{vj} = 25^{\circ}\text{C}$	–	128	–	ns
		$V_{GE} = +15/-8\text{ V}, T_{vj} = 150^{\circ}\text{C}$	–	121	–	
		$R_{g,on} = 3\ \Omega, T_{vj} = 175^{\circ}\text{C}$	–	118	–	
T_r	Rise Time, Inductive Load	$I_C = 300\text{ A}, V_{CE} = 600\text{ V}, T_{vj} = 25^{\circ}\text{C}$	–	59	–	ns
		$V_{GE} = +15/-8\text{ V}, T_{vj} = 150^{\circ}\text{C}$	–	66	–	
		$R_{g,on} = 3\ \Omega, T_{vj} = 175^{\circ}\text{C}$	–	68	–	
$T_{d,off}$	Turn Off Delay, Inductive Load	$I_C = 300\text{ A}, V_{CE} = 600\text{ V}, T_{vj} = 25^{\circ}\text{C}$	–	1070	–	ns
		$V_{GE} = +15/-8\text{ V}, T_{vj} = 150^{\circ}\text{C}$	–	1132	–	
		$R_{g,off} = 5\ \Omega, T_{vj} = 175^{\circ}\text{C}$	–	1157	–	
T_f	Fall Time, Inductive Load	$I_C = 300\text{ A}, V_{CE} = 600\text{ V}, T_{vj} = 25^{\circ}\text{C}$	–	103	–	ns
		$V_{GE} = +15/-8\text{ V}, T_{vj} = 150^{\circ}\text{C}$	–	250	–	
		$R_{g,off} = 5\ \Omega, T_{vj} = 175^{\circ}\text{C}$	–	281	–	
E_{ON}	Turn-On Switching Loss (Including Diode Reverse Recovery Loss)	$I_C = 300\text{ A}, V_{CE} = 600\text{ V}, T_{vj} = 25^{\circ}\text{C}$	–	18	–	mJ
		$V_{GE} = +15/-8\text{ V}, T_{vj} = 150^{\circ}\text{C}$	–	28	–	
		$R_{g,on} = 3\ \Omega, T_{vj} = 175^{\circ}\text{C}$	–	30	–	
		$L_s = 25\text{ nH}$ $di/dt (T_{vj}=25^{\circ}\text{C}) = 4.06\text{ A/ns}$ $di/dt (T_{vj}=175^{\circ}\text{C}) = 3.95\text{ A/ns}$				
E_{OFF}	Turn-Off Switching Loss	$I_C = 300\text{ A}, V_{CE} = 600\text{ V}, T_{vj} = 25^{\circ}\text{C}$	–	19	–	mJ
		$V_{GE} = +15/-8\text{ V}, T_{vj} = 150^{\circ}\text{C}$	–	34	–	
		$R_{g,off} = 5\ \Omega, T_{vj} = 175^{\circ}\text{C}$	–	37	–	
		$L_s = 25\text{ nH}$ $dv/dt (T_{vj}=25^{\circ}\text{C}) = 4.15\text{ V/ns}$ $dv/dt (T_{vj}=175^{\circ}\text{C}) = 3.21\text{ V/ns}$				
Esc	Minimum Short Circuit Energy Withstand	$V_{GE} = 15\text{ V}, V_{CC} = 600\text{ V}, T_{vj} = 25^{\circ}\text{C}$	16	–	–	J
		$T_{vj} = 175^{\circ}\text{C}$	8.8	–	–	

VE-Trac™ Dual NVG450A120L5DSC

CHARACTERISTICS OF INVERSE DIODE (T_{vj} = 25°C, unless otherwise specified)

Parameters		Conditions	Min	Typ	Max	unit	
V _F	Diode Forward Voltage (Terminal)	V _{GE} = 0 V, I _C = 300 A,	T _{vj} = 25°C	–	1.58	1.82	V
			T _{vj} = 150°C	–	1.56	–	
			T _{vj} = 175°C	–	1.54	–	
		V _{GE} = 0 V, I _C = 450 A,	T _{vj} = 25°C	–	1.80	–	
			T _{vj} = 150°C	–	1.81	–	
			T _{vj} = 175°C	–	1.78	–	
E _{rr}	Reverse Recovery Energy	V _R = 600 V, I _F = 300 A, R _{GON} = 3 Ω, –di/dt = 3.95 A/ns (175°C) V _{GE} = –8 V	T _{vj} = 25°C	–	10	–	mJ
			T _{vj} = 150°C	–	22	–	
			T _{vj} = 175°C	–	24	–	
				–	–	–	
Q _{RR}	Recovered Charge	V _R = 600 V, I _F = 300 A, R _{GON} = 3 Ω, –di/dt = 3.95 A/ns (175°C) V _{GE} = –8 V	T _{vj} = 25°C	–	25	–	μC
			T _{vj} = 150°C	–	53	–	
			T _{vj} = 175°C	–	59	–	
				–	–	–	
I _{rr}	Peak Reverse Recovery Current	V _R = 600 V, I _F = 300 A, R _{GON} = 3 Ω, –di/dt = 3.95 A/ns (175°C) V _{GE} = –8 V	T _{vj} = 25°C	–	250	–	A
			T _{vj} = 150°C	–	332	–	
			T _{vj} = 175°C	–	343	–	
				–	–	–	

SENSOR CHARACTERISTICS (T_{vj} = 25°C, unless otherwise specified)

Parameters		Conditions	Min	Typ	Max	unit		
T _{sense}	Temperature Sense	I _F = 250 μA,	T _{vj} = –40°C	–	3.40	–	V	
			T _{vj} = 25°C	2.95	3.01	3.086		
				(Note 3)	–	(Note 3)		–
			T _{vj} = 150°C	–	2.27	–		
I _{sense}	Current Sense	R _{shunt} = 10 Ω,	I _C = 600 A	–	392	–	mV	
			I _C = 300 A	–	254	–		
			I _C = 200 A	–	209	–		
		R _{shunt} = 20 Ω,	I _C = 600 A	–	566	–		
			I _C = 300 A	–	377	–		
			I _C = 200 A	–	314	–		

3. Measured at final test.

VE-Trac™ Dual NVG450A120L5DSC

TYPICAL CHARACTERISTICS

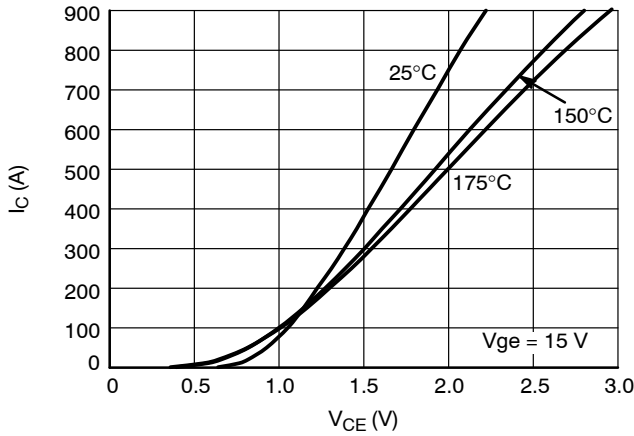

Figure 1. IGBT Output Characteristic

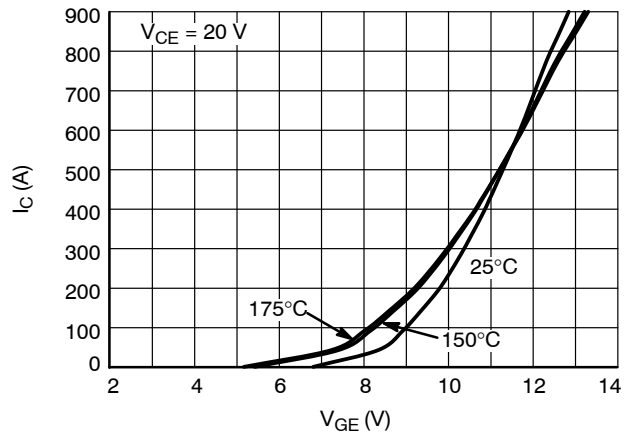

Figure 2. IGBT Transfer Characteristic

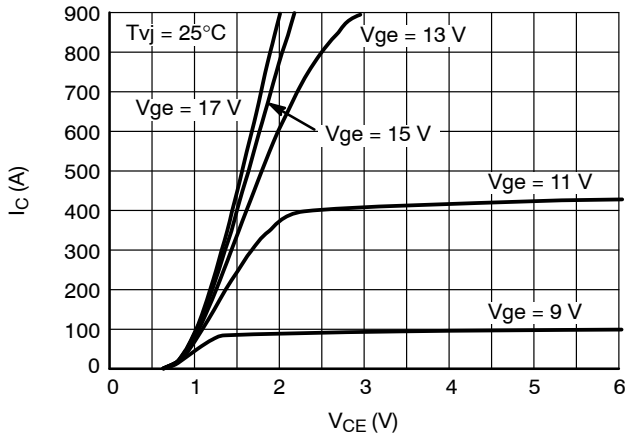

Figure 3. IGBT Output Characteristic

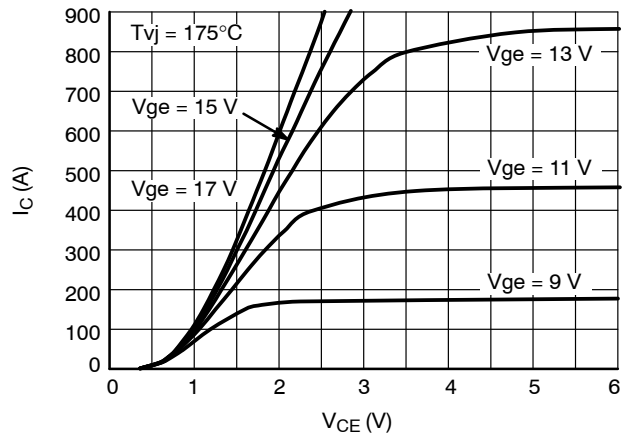

Figure 4. IGBT Output Characteristic

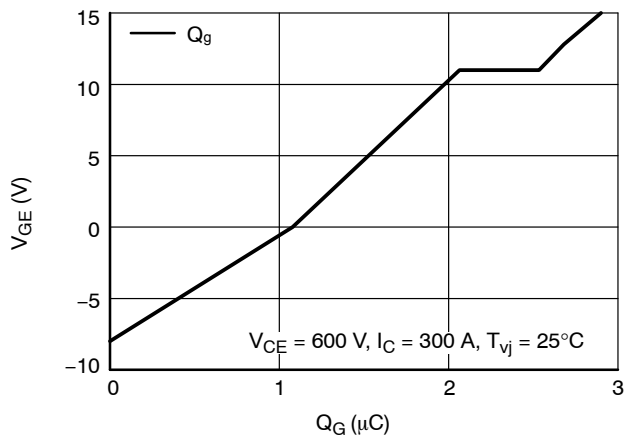

Figure 5. Gate Charge Characteristic

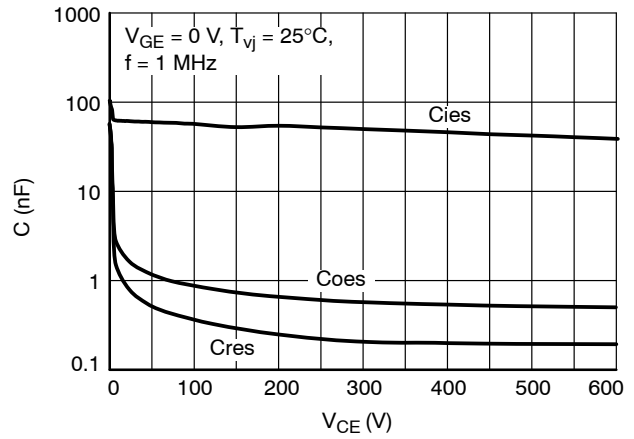

Figure 6. Capacitance Characteristic

VE-Trac™ Dual NVG450A120L5DSC

TYPICAL CHARACTERISTICS

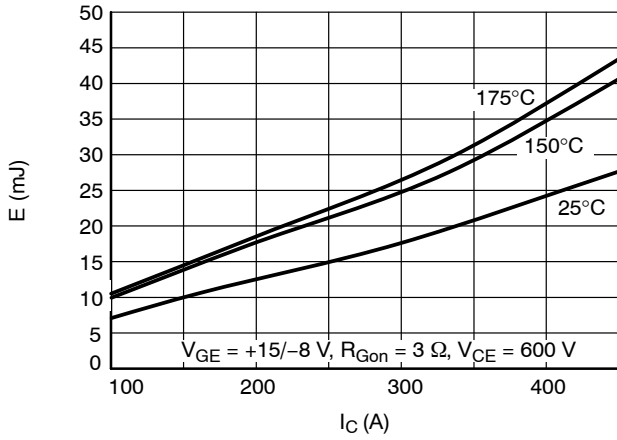

Figure 7. IGBT Turn-on Losses vs. I_C

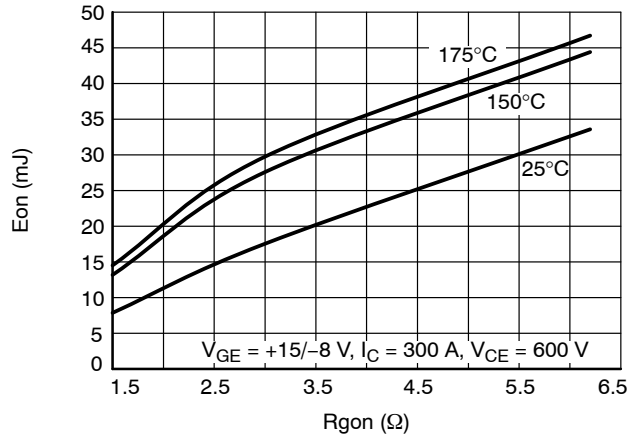

Figure 8. IGBT Turn-on Losses vs. R_{gon}

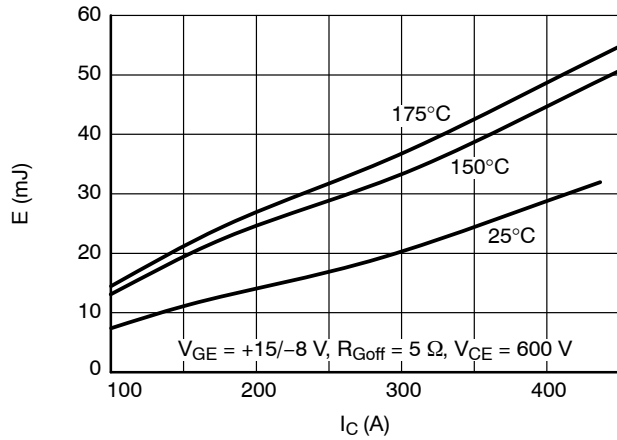

Figure 9. IGBT Turn-off Losses vs. I_C

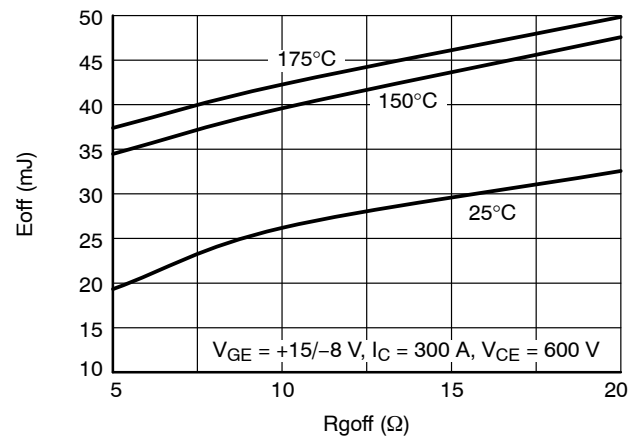

Figure 10. IGBT Turn-off Losses vs. R_{goff}

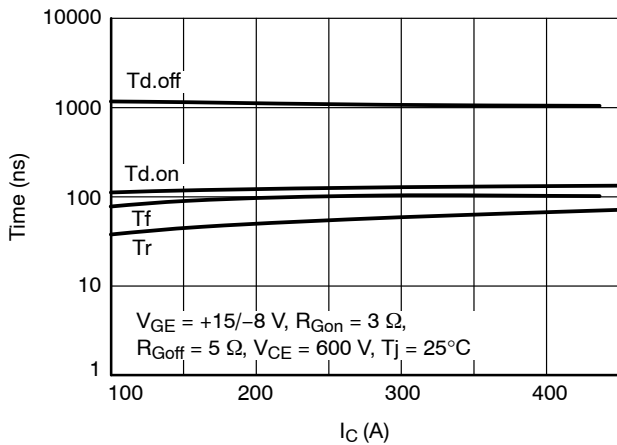

Figure 11. IGBT Switching Times vs. I_C , $T_{vj} = 25^\circ\text{C}$

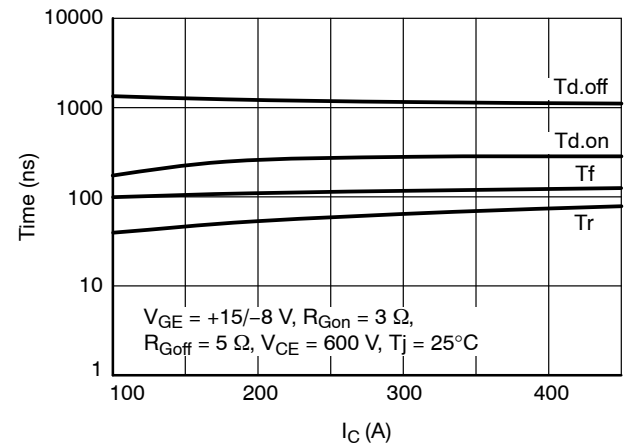

Figure 12. IGBT Switching Times vs. I_C , $T_{vj} = 175^\circ\text{C}$

VE-Trac™ Dual NVG450A120L5DSC

TYPICAL CHARACTERISTICS

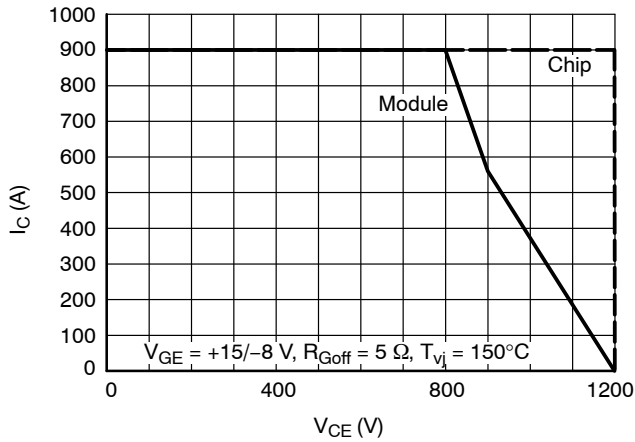

Figure 13. Reverse Bias Safe Operating Area

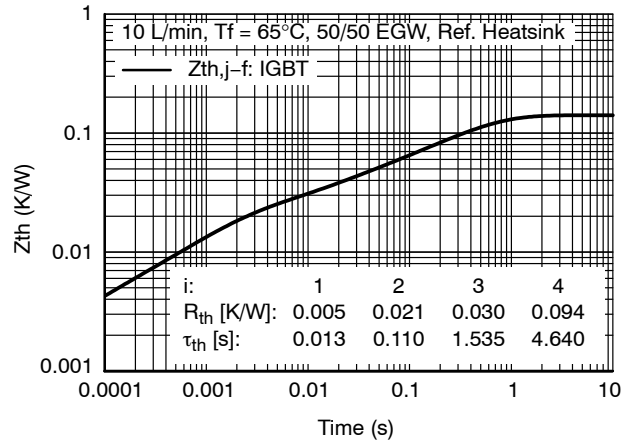

Figure 14. IGBT Transient Thermal Impedance

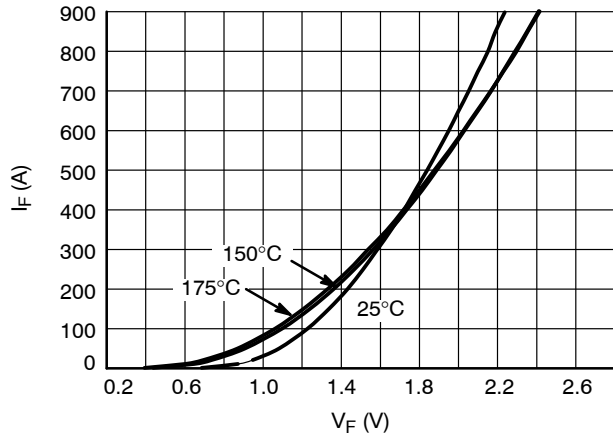

Figure 15. Diode Forward Characteristics

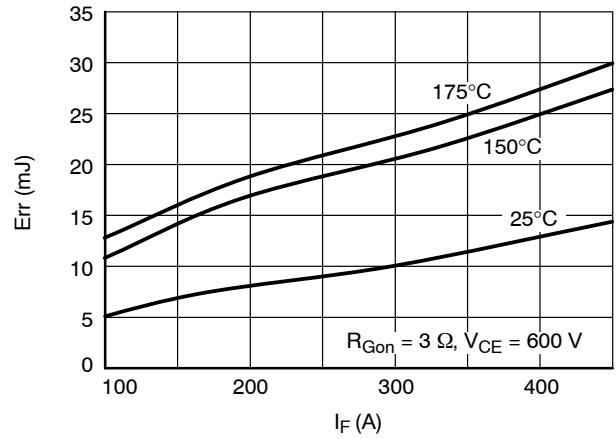

Figure 16. Diode Switching Losses vs. I_F

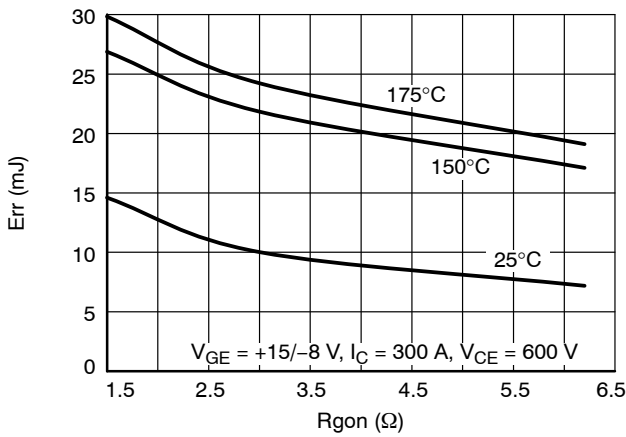

Figure 17. Diode Reverse Recovery Losses vs. R_{gon}

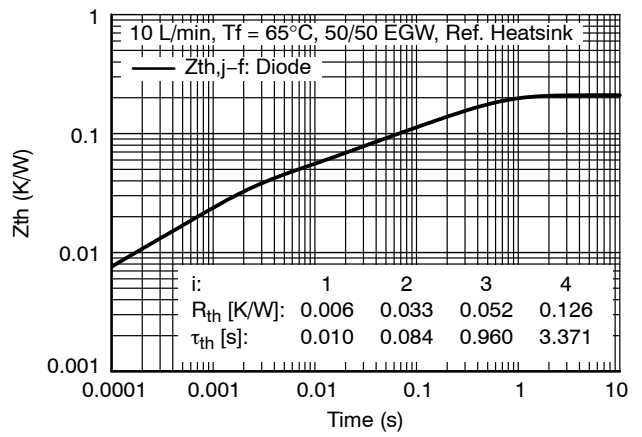

Figure 18. Diode Transient Thermal Impedance

VE-Trac™ Dual NVG450A120L5DSC

TYPICAL CHARACTERISTICS

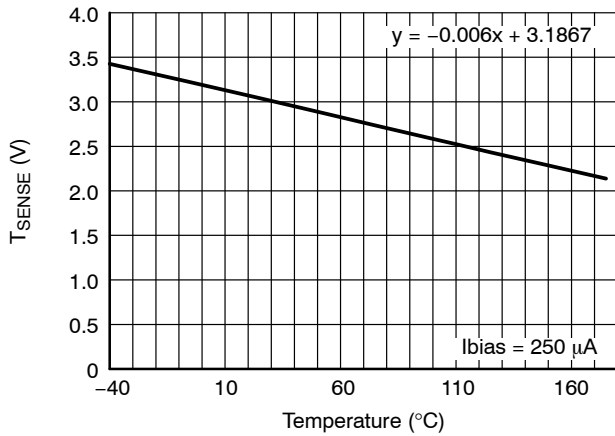

Figure 19. Temperature Sensor Characteristics

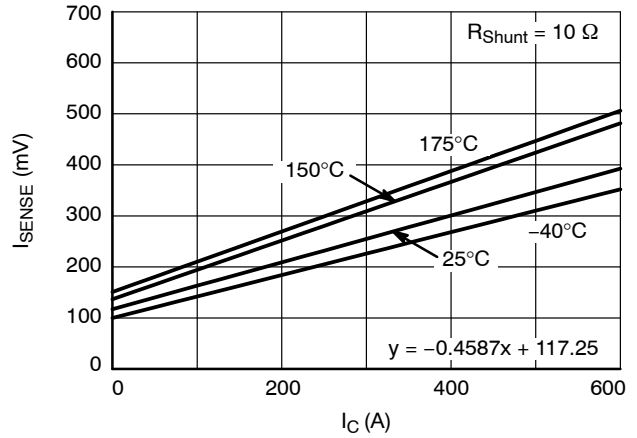

Figure 20. Current Sensor Characteristics

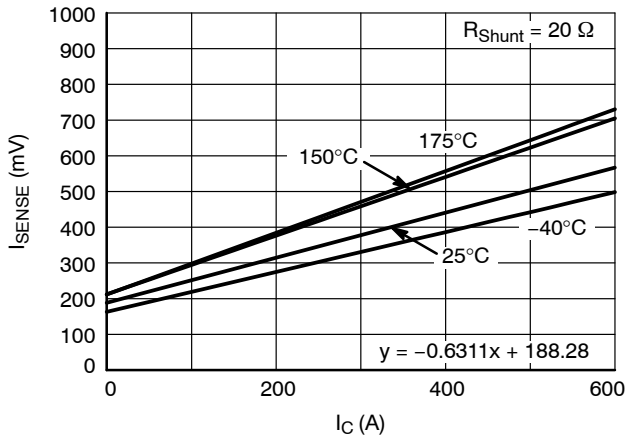
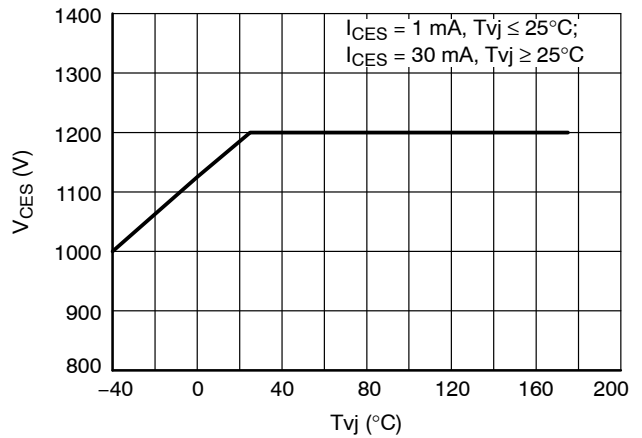

Figure 21. Current Sensor Characteristics



Verified by characterization/design, not by test.

Figure 22. Maximum Allowed V_{ce}

ORDERING INFORMATION

Device	Device Marking	Package	Shipping
NVG450A120L5DSC	N412DSC	AHPM15-CEA (Pb-Free)	6 Unit / Tube

VE-Trac is a trademark of Semiconductor Components Industries, LLC (SCILLC) or its subsidiaries in the United States and/or other countries.

MECHANICAL CASE OUTLINE PACKAGE DIMENSIONS



AHPM15-CEA CASE 100DD ISSUE B

DATE 28 SEP 2022

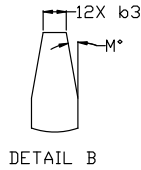
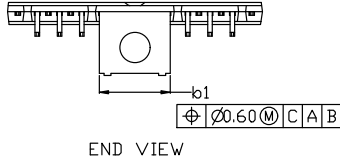

NOTES:

1. DIMENSIONING AND TOLERANCING PER ASME Y14.5M, 2009.
2. CONTROLLING DIMENSION: MILLIMETERS
3. DIMENSIONS D & E DO NOT INCLUDE MOLD PROTRUSIONS
4. DIMENSIONS b, b1, b2 DO NOT INCLUDE DAMBAR REMAIN.
5. MARKING AREA.
6. E4 IS FROM INNER LEAD TIP TO INNER LEAD TIP DISTANCE.

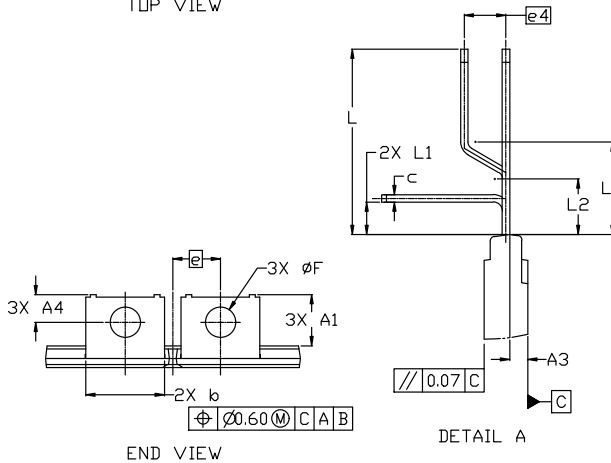
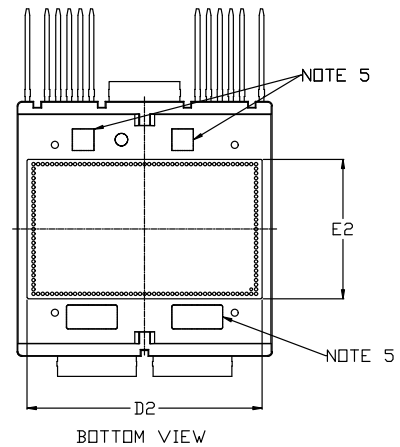
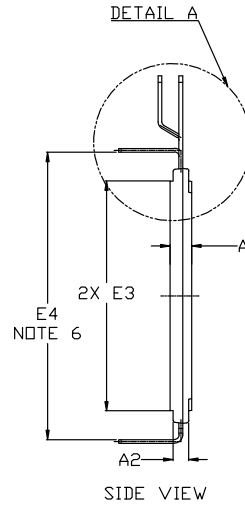
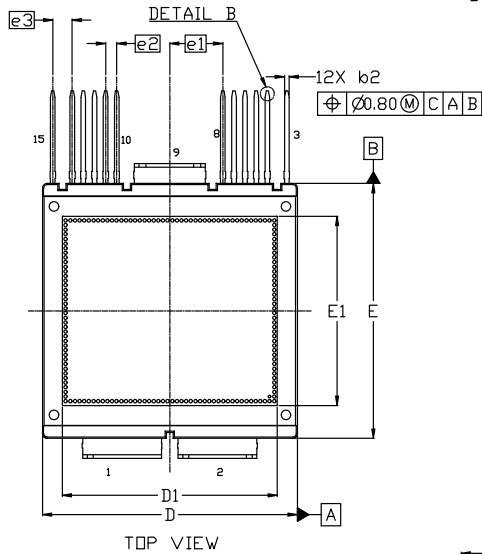

DIM	MILLIMETERS		
	MIN.	NOM.	MAX.
A	4.65	4.70	4.75
A1	10.75	11.05	11.35
A2	3.20	3.40	3.60
A3	1.60	1.95	2.30
A4	5.70	6.00	6.30
b	16.90	17.00	17.10
b1	15.20	15.30	15.40
b2	0.90	1.00	1.10
b3	0.50 REF		
c	0.70	0.80	0.90
D	54.80	55.00	55.20
D1	46.20	46.50	46.80
D2	50.70	51.00	51.30

DIM	MILLIMETERS		
	MIN.	NOM.	MAX.
E	54.80	55.00	55.20
E1	40.50	40.80	41.10
E2	29.80	30.10	30.40
E3	49.40	49.60	49.80
E4	61.75	62.00	62.25
e	10.30 BSC		
e1	11.45 BSC		
e2	2.40 BSC		
e3	4.20 BSC		
e4	4.50 BSC		
F	6.45	6.50	6.55
L	19.60	20.00	20.40
L1	3.10	3.50	3.90
L2	5.70	6.00	6.30
L3	9.70	10.00	10.30
M	10° REF		

GENERIC MARKING DIAGRAM*



- ZZZ = Assembly Lot Code
- AT = Assembly & Test Site Code
- Y = Year
- WW = Work Week
- XXXX = Specific Device Code
- NNN = Serial Number

*This information is generic. Please refer to device data sheet for actual part marking. Pb-Free indicator, "G" or microdot "µ", may or may not be present. Some products may not follow the Generic Marking.

DOCUMENT NUMBER:	98AON86580G	Electronic versions are uncontrolled except when accessed directly from the Document Repository. Printed versions are uncontrolled except when stamped "CONTROLLED COPY" in red.
DESCRIPTION:	AHPM15-CEA	PAGE 1 OF 1

onsemi and ONSEMI are trademarks of Semiconductor Components Industries, LLC dba onsemi or its subsidiaries in the United States and/or other countries. onsemi reserves the right to make changes without further notice to any products herein. onsemi makes no warranty, representation or guarantee regarding the suitability of its products for any particular purpose, nor does onsemi assume any liability arising out of the application or use of any product or circuit, and specifically disclaims any and all liability, including without limitation special, consequential or incidental damages. onsemi does not convey any license under its patent rights nor the rights of others.

onsemi, **Onsemi**, and other names, marks, and brands are registered and/or common law trademarks of Semiconductor Components Industries, LLC dba "**onsemi**" or its affiliates and/or subsidiaries in the United States and/or other countries. **onsemi** owns the rights to a number of patents, trademarks, copyrights, trade secrets, and other intellectual property. A listing of **onsemi**'s product/patent coverage may be accessed at www.onsemi.com/site/pdf/Patent-Marking.pdf. **onsemi** reserves the right to make changes at any time to any products or information herein, without notice. The information herein is provided "as-is" and **onsemi** makes no warranty, representation or guarantee regarding the accuracy of the information, product features, availability, functionality, or suitability of its products for any particular purpose, nor does **onsemi** assume any liability arising out of the application or use of any product or circuit, and specifically disclaims any and all liability, including without limitation special, consequential or incidental damages. Buyer is responsible for its products and applications using **onsemi** products, including compliance with all laws, regulations and safety requirements or standards, regardless of any support or applications information provided by **onsemi**. "Typical" parameters which may be provided in **onsemi** data sheets and/or specifications can and do vary in different applications and actual performance may vary over time. All operating parameters, including "Typicals" must be validated for each customer application by customer's technical experts. **onsemi** does not convey any license under any of its intellectual property rights nor the rights of others. **onsemi** products are not designed, intended, or authorized for use as a critical component in life support systems or any FDA Class 3 medical devices or medical devices with a same or similar classification in a foreign jurisdiction or any devices intended for implantation in the human body. Should Buyer purchase or use **onsemi** products for any such unintended or unauthorized application, Buyer shall indemnify and hold **onsemi** and its officers, employees, subsidiaries, affiliates, and distributors harmless against all claims, costs, damages, and expenses, and reasonable attorney fees arising out of, directly or indirectly, any claim of personal injury or death associated with such unintended or unauthorized use, even if such claim alleges that **onsemi** was negligent regarding the design or manufacture of the part. **onsemi** is an Equal Opportunity/Affirmative Action Employer. This literature is subject to all applicable copyright laws and is not for resale in any manner.

ADDITIONAL INFORMATION

TECHNICAL PUBLICATIONS:

Technical Library: www.onsemi.com/design/resources/technical-documentation
onsemi Website: www.onsemi.com

ONLINE SUPPORT: www.onsemi.com/support

For additional information, please contact your local Sales Representative at www.onsemi.com/support/sales

