

NCP51199, NCV51199

DDR 2-Amp Source / Sink V_{TT} Termination Regulator

The NCP/NCV51199 is a linear regulator designed to supply a regulated V_{TT} termination voltage for DDR-2 and DDR-3 memory applications. The regulator is capable of actively sourcing and sinking ± 2 A peak currents for DDR-2, and DDR-3 up to ± 1.5 A while regulating the V_{TT} output voltage to within ± 10 mV. The output termination voltage is regulated to track $V_{DDQ} / 2$ by two external voltage divider resistors connected to the PV_{CC} , GND, and V_{REF} pins.

The NCP/NCV51199 incorporates a high-speed differential amplifier to provide ultra-fast response to line and load transients. Other features include source/sink current limiting, soft-start and on-chip thermal shutdown protection.

Features

- Supports DDR-2 V_{TT} Termination to ± 2 A, DDR-3 to ± 1.5 A (peak)
- Stable with 10 μ F Ceramic Capacitance on V_{TT} Output
- Integrated Power MOSFETs
- High Accuracy V_{TT} Output at Full-Load
- Fast Transient Response
- Built-in Soft-Start
- Shutdown for Standby or Suspend Mode
- Integrated Thermal and Current-Limit Protection
- NCV Prefix for Automotive and Other Applications Requiring Unique Site and Control Change Requirements; AEC-Q100 Qualified and PPAP Capable
- These Devices are Pb-Free and are RoHS Compliant

Typical Applications

- SDRAM Termination Voltage for DDR-2 / DDR-3
- Motherboard, Notebook, and VGA Card Memory Termination
- Set Top Box, Digital TV, Printers



ON Semiconductor®

www.onsemi.com

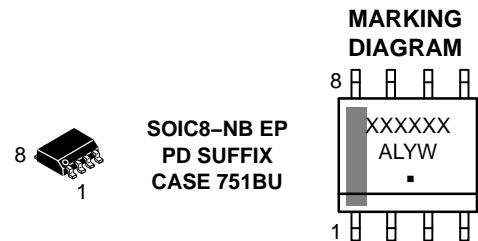

XXXXXX = Specific Device Code
A = Assembly Location
L = Wafer Lot
Y = Year
WW = Work Week
▪ = Pb-Free Package

PIN CONNECTION

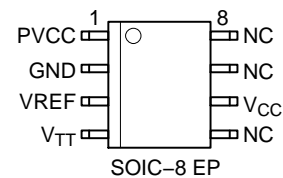

ORDERING INFORMATION

See detailed ordering, marking and shipping information in the package dimensions section on page 6 of this data sheet.

NCP51199, NCV51199

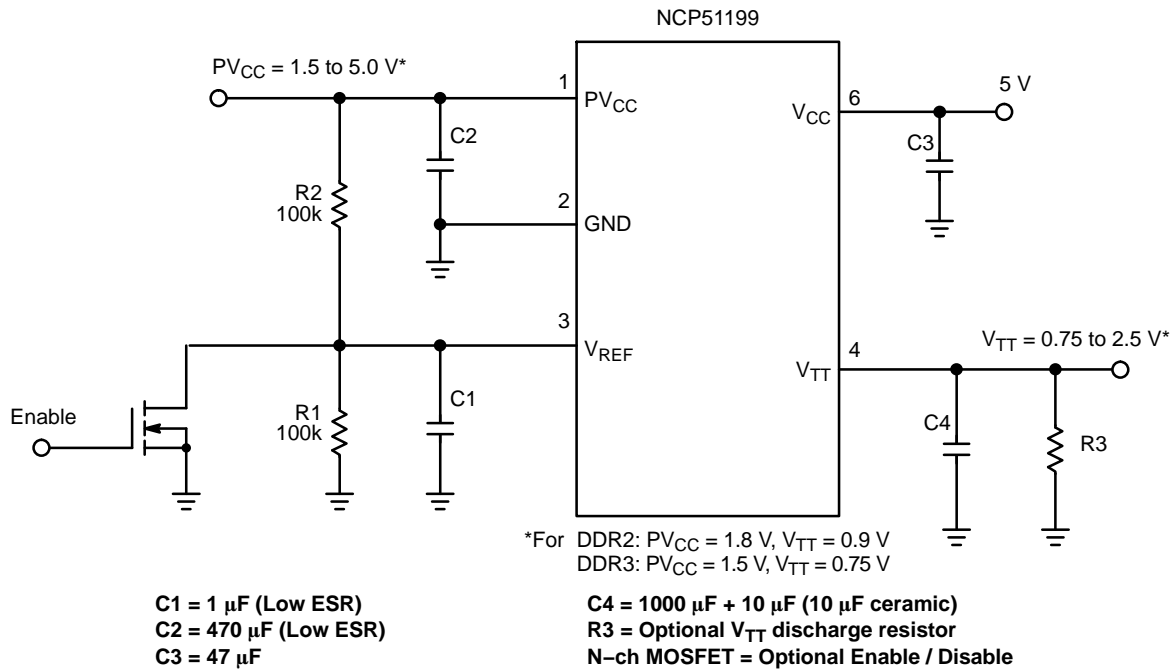

Figure 1. Application Diagram

PIN FUNCTION DESCRIPTION

Pin No.	Pin Name	Description
1	PV _{CC}	Input voltage which supplies current to the output pin. C _{IN} = 470 μF with low ESR.
2	GND	Common Ground
3	V _{REF}	Buffered reference voltage input equal to 1/2 of V _{DDQ} and active low shutdown pin. An external resistor divider dividing down the PV _{CC} voltage creates the regulated output voltage. Pulling the pin to ground (0.15 V maximum) turns the device off.
4	V _{TT}	Regulator output voltage capable of sourcing and sinking current while regulating the output rail. C _{OUT} = 1000 μF + 10 μF ceramic with low ESR.
5	NC	True No Connect
6	V _{CC}	The V _{CC} pin is a 5 V input pin that provides internal bias to the controller. PV _{CC} should always be kept lower or equal to V _{CC} .
7	NC	True No Connect
8	NC	True No Connect
EP	Thermal Pad	Pad for thermal connection. The exposed pad must be connected to the ground plane using multiple vias for maximum power dissipation performance.

NCP51199, NCV51199

ABSOLUTE MAXIMUM RATINGS

Rating	Symbol	Value	Unit
Input Supply Voltage Range ($V_{CC} \geq PV_{CC}$) (Note 1)	PV_{CC}, V_{CC}	-0.3 to 6	V
Output Voltage Range	V_{TT}	-0.3 to 6	V
Reference Input Range	V_{REF}	-0.3 to 6	V
Maximum Junction Temperature	$T_{J(max)}$	125	°C
Storage Temperature Range	TSTG	-65 to 150	°C
ESD Capability, Human Body Model (Note 2)	ESDHBM	2	kV
ESD Capability, Machine Model (Note 2)	ESDMM	150	V
Lead Temperature Soldering Reflow (SMD Styles Only), Pb-Free Versions (Note 3)	T_{SLD}	260	°C

Stresses exceeding those listed in the Maximum Ratings table may damage the device. If any of these limits are exceeded, device functionality should not be assumed, damage may occur and reliability may be affected.

1. Refer to ELECTRICAL CHARACTERISTICS and APPLICATION INFORMATION for Safe Operating Area.
2. This device series incorporates ESD protection and is tested by the following methods:
ESD Human Body Model tested per AEC-Q100-002 (EIA/JESD22-A114)
ESD Machine Model tested per AEC-Q100-003 (EIA/JESD22-A115)
Latchup Current Maximum Rating: ≤ 150 mA per JEDEC standard: JESD78
3. For information, please refer to our Soldering and Mounting Techniques Reference Manual, SOLDERRM/D

THERMAL CHARACTERISTICS

Rating	Symbol	Value	Unit
Thermal Characteristics, SO8-EP (Note 4) Thermal Resistance, Junction-to-Air (Note 5) Power Rating at 25°C Ambient = 1.19 W, derate 12 mW/°C Thermal Reference, Junction-to-Lead2 (Note 5)	$R_{\theta JA}$ $R_{\psi JL}$	84 20	°C/W

4. Refer to ELECTRICAL CHARACTERISTICS and APPLICATION INFORMATION for Safe Operating Area.
5. Values based on copper area of 645 mm² (or 1 in²) of 1 oz copper thickness and FR4 PCB substrate.

OPERATING RANGES (Note 6)

Rating	Symbol	Min	Max	Unit
Input Voltage	PV_{CC}	1.5	5.5	V
Bias Supply Voltage	V_{CC}	4.75	5.25	V
Ambient Temperature	T_A	-40	85	°C
Junction Temperature	T_J	-40	125	°C

6. Refer to ELECTRICAL CHARACTERISTICS and APPLICATION INFORMATION for Safe Operating Area.

NCP51199, NCV51199

ELECTRICAL CHARACTERISTICS

$PV_{CC} = 1.8\text{ V} / 1.5\text{ V}$; $V_{CC} = 5\text{ V}$; $V_{REF} = 0.9\text{ V} / 0.75\text{ V}$; $C_{OUT} = 10\text{ }\mu\text{F}$ (Ceramic); $T_A = +25^\circ\text{C}$, unless otherwise noted.

Parameter	Test Conditions	Symbol	Min	Typ	Max	Unit
-----------	-----------------	--------	-----	-----	-----	------

REGULATOR OUTPUT

Output Offset Voltage	$I_{out} = 0\text{ A}$	V_{OS}	-20	-	+20	mV
Load Regulation	$V_{REF} = 900\text{ mV}$, $I_{out} = \pm 1.8\text{ A}$, $PV_{CC} = 1.8\text{ V}$ $V_{REF} = 750\text{ mV}$, $I_{out} = \pm 1.4\text{ A}$, $PV_{CC} = 1.5\text{ V}$	Reg_{load}	-10	-	+10	mV

INPUT AND STANDBY CURRENTS

Bias Supply Current	$I_{out} = 0\text{ A}$	I_{BIAS}	-	0.8	2.5	mA
Standby Current	$V_{REF} < 0.2\text{ V}$ (Shutdown), $R_{LOAD} = 180\Omega$	I_{STB}	-	1	90	μA

CURRENT LIMIT PROTECTION

Current Limit	$PV_{CC} = 1.8\text{ V}$, $V_{REF} = 0.9\text{ V}$	I_{LIM}	2.0	-	3.5	A
	$PV_{CC} = 1.5\text{ V}$, $V_{REF} = 0.75\text{ V}$		1.5	-	3.5	

SHUTDOWN THRESHOLDS

Shutdown Threshold Voltage	Enable	V_{IH}	0.6	-	-	V
	Shutdown	V_{IL}	-	-	0.15	

THERMAL SHUTDOWN

Thermal Shutdown Temperature	$V_{CC} = 5\text{ V}$	T_{SD}	160	168	176	$^\circ\text{C}$
Thermal Shutdown Hysteresis	$V_{CC} = 5\text{ V}$	T_{SH}	35	35	40	$^\circ\text{C}$

TYPICAL CHARACTERISTICS

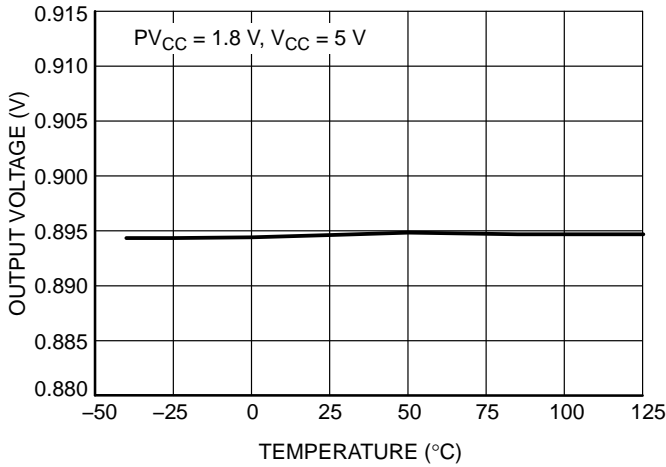

Figure 2. Output Voltage vs. Temperature

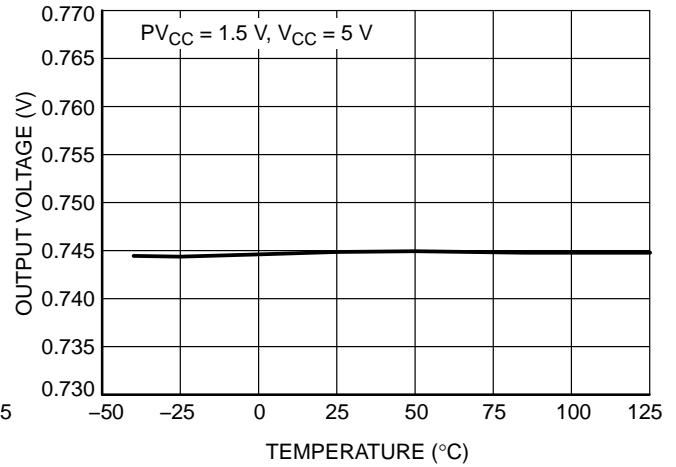

Figure 3. Output Voltage vs. Temperature

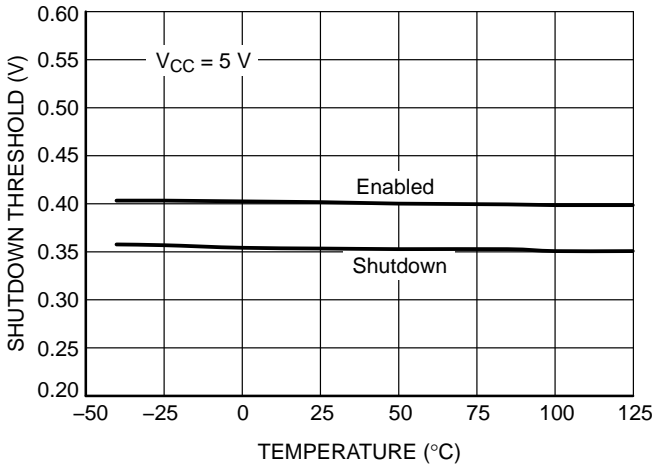

Figure 4. Shutdown Threshold vs. Temperature

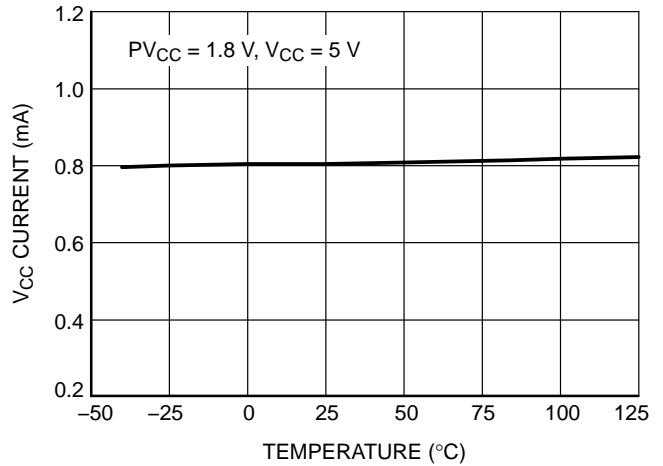

Figure 5. VCC Current vs. Temperature

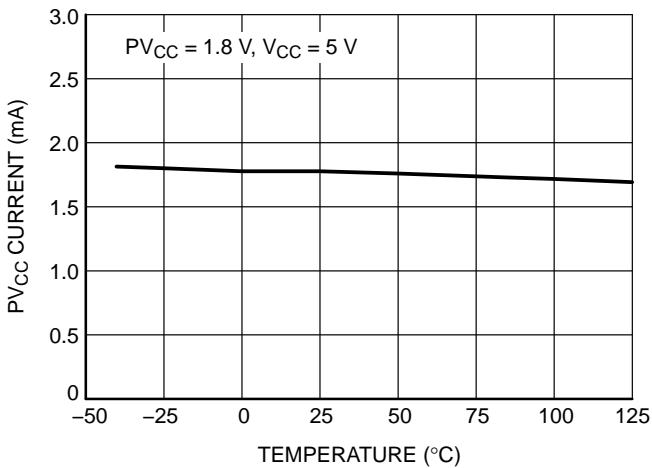

Figure 6. PVCC Current vs. Temperature

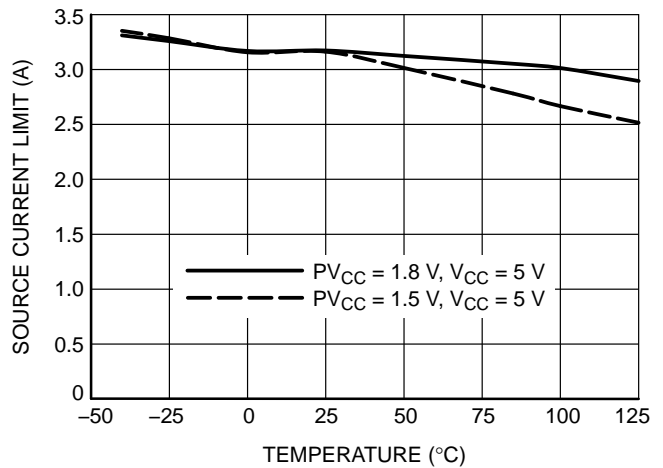

Figure 7. Source Current Limits vs. Temperature

NCP51199, NCV51199

TYPICAL CHARACTERISTICS

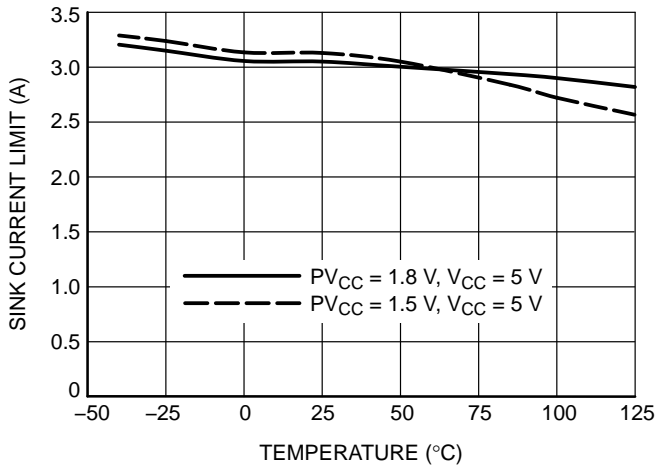

Figure 8. Sink Current Limits vs. Temperature

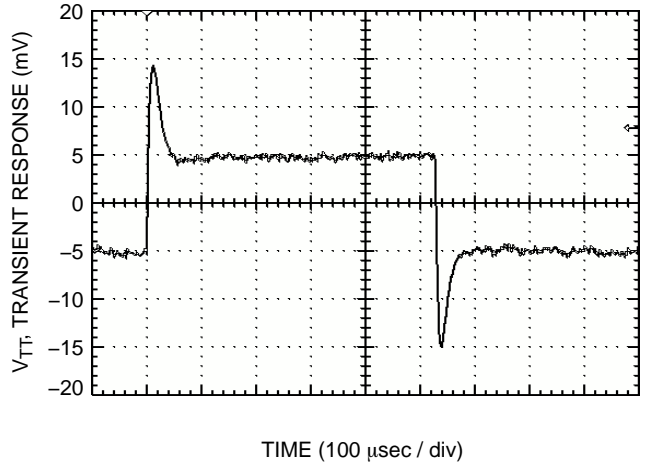

Figure 9. 1.25 V, ±1.6 A Transient Response

Table 1. ORDERING INFORMATION

Device	Marking	Package	Shipping †
NCP51199PDR2G	51199	SOIC-8 (Pb-Free)	2500 / Tape & Reel
NCV51199PDR2G*	V51199		

†For information on tape and reel specifications, including part orientation and tape sizes, please refer to our Tape and Reel Packaging Specifications Brochure, BRD8011/D.

*NCV Prefix for Automotive and Other Applications Requiring Unique Site and Control Change Requirements; AEC-Q100 Qualified and PPAP Capable.

MECHANICAL CASE OUTLINE PACKAGE DIMENSIONS

ON Semiconductor®



SCALE 1:1

SOIC8-NB EP CASE 751BU ISSUE E

DATE 01 APR 2015

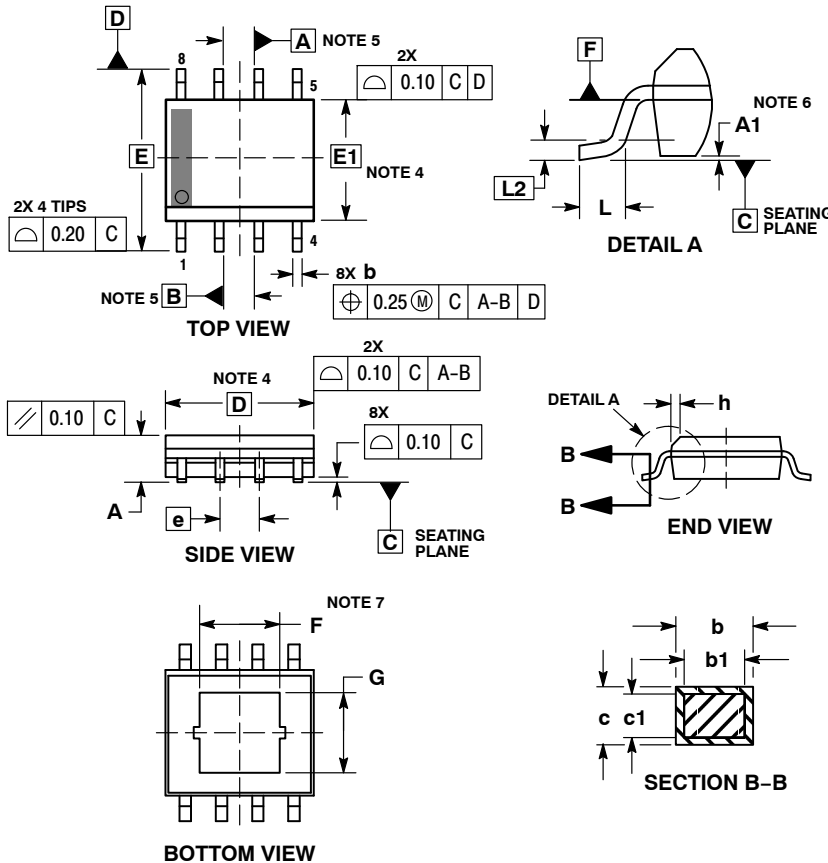

DIM	MILLIMETERS	
	MIN	MAX
A	1.35	1.75
A1	0.00	0.10
<i>b</i>	0.31	0.51
<i>b1</i>	0.28	0.48
<i>c</i>	0.17	0.25
<i>c1</i>	0.17	0.23
<i>D</i>	4.90 BSC	
<i>E</i>	6.00 BSC	
<i>E1</i>	3.90 BSC	
<i>e</i>	1.27 BSC	
<i>F</i>	1.55	2.39
<i>G</i>	1.55	2.39
<i>h</i>	0.25	0.50
<i>L</i>	0.40	1.27
<i>L2</i>	0.25 BSC	

GENERIC MARKING DIAGRAM*

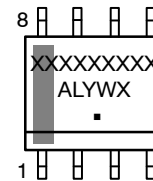

- XXXXX = Specific Device Code
- A = Assembly Location
- L = Wafer Lot
- Y = Year
- W = Work Week
- = Pb-Free Package

*This information is generic. Please refer to device data sheet for actual part marking. Pb-Free indicator, "G", may or not be present.

*For additional information on our Pb-Free strategy and soldering details, please download the ON Semiconductor Soldering and Mounting Techniques Reference Manual, SOLDERRM/D.

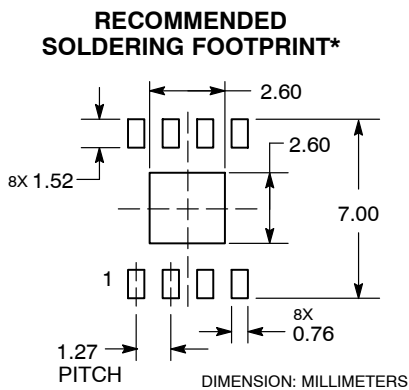

DOCUMENT NUMBER:	98AON66222E	Electronic versions are uncontrolled except when accessed directly from the Document Repository. Printed versions are uncontrolled except when stamped "CONTROLLED COPY" in red.
DESCRIPTION:	SOIC8-NB EP	PAGE 1 OF 1

ON Semiconductor and ON are trademarks of Semiconductor Components Industries, LLC dba ON Semiconductor or its subsidiaries in the United States and/or other countries. ON Semiconductor reserves the right to make changes without further notice to any products herein. ON Semiconductor makes no warranty, representation or guarantee regarding the suitability of its products for any particular purpose, nor does ON Semiconductor assume any liability arising out of the application or use of any product or circuit, and specifically disclaims any and all liability, including without limitation special, consequential or incidental damages. ON Semiconductor does not convey any license under its patent rights nor the rights of others.

onsemi, **Onsemi**, and other names, marks, and brands are registered and/or common law trademarks of Semiconductor Components Industries, LLC dba "**onsemi**" or its affiliates and/or subsidiaries in the United States and/or other countries. **onsemi** owns the rights to a number of patents, trademarks, copyrights, trade secrets, and other intellectual property. A listing of **onsemi**'s product/patent coverage may be accessed at www.onsemi.com/site/pdf/Patent-Marking.pdf. **onsemi** reserves the right to make changes at any time to any products or information herein, without notice. The information herein is provided "as-is" and **onsemi** makes no warranty, representation or guarantee regarding the accuracy of the information, product features, availability, functionality, or suitability of its products for any particular purpose, nor does **onsemi** assume any liability arising out of the application or use of any product or circuit, and specifically disclaims any and all liability, including without limitation special, consequential or incidental damages. Buyer is responsible for its products and applications using **onsemi** products, including compliance with all laws, regulations and safety requirements or standards, regardless of any support or applications information provided by **onsemi**. "Typical" parameters which may be provided in **onsemi** data sheets and/or specifications can and do vary in different applications and actual performance may vary over time. All operating parameters, including "Typicals" must be validated for each customer application by customer's technical experts. **onsemi** does not convey any license under any of its intellectual property rights nor the rights of others. **onsemi** products are not designed, intended, or authorized for use as a critical component in life support systems or any FDA Class 3 medical devices or medical devices with a same or similar classification in a foreign jurisdiction or any devices intended for implantation in the human body. Should Buyer purchase or use **onsemi** products for any such unintended or unauthorized application, Buyer shall indemnify and hold **onsemi** and its officers, employees, subsidiaries, affiliates, and distributors harmless against all claims, costs, damages, and expenses, and reasonable attorney fees arising out of, directly or indirectly, any claim of personal injury or death associated with such unintended or unauthorized use, even if such claim alleges that **onsemi** was negligent regarding the design or manufacture of the part. **onsemi** is an Equal Opportunity/Affirmative Action Employer. This literature is subject to all applicable copyright laws and is not for resale in any manner.

ADDITIONAL INFORMATION

TECHNICAL PUBLICATIONS:

Technical Library: www.onsemi.com/design/resources/technical-documentation
onsemi Website: www.onsemi.com

ONLINE SUPPORT: www.onsemi.com/support

For additional information, please contact your local Sales Representative at www.onsemi.com/support/sales