

4-Pin DIP Phototransistor Optocouplers

FOD814, FOD817

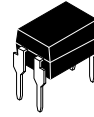

PDIP4
 CASE 646CD
 CASE 646CA

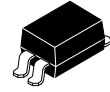

PDIP4 GW
 CASE 709AH

Introduction or Description

The FOD814 consists of two gallium arsenide infrared emitting diodes, connected in inverse parallel, driving a silicon phototransistor output in a 4-pin dual in-line package. The FOD817 Series consists of a gallium arsenide infrared emitting diode driving a silicon phototransistor in a 4-pin dual in-line package.

Features

- AC Input Response (FOD814)
 - ◆ FOD814: 20–300%
 - ◆ FOD814A: 50–150%
 - ◆ FOD817: 50–600%
 - ◆ FOD817A: 80–160%
 - ◆ FOD817B: 130–260%
 - ◆ FOD817C: 200–400%
 - ◆ FOD817D: 300–600%
- Minimum BV_{CEO} of 70 V Guaranteed
- Safety and Regulatory Approvals
 - ◆ UL1577, 5,000 VAC_{RMS} for 1 Minute
 - ◆ DIN EN/IEC60747–5–5
- This Device is Pb-Free

Typical Applications

- FOD814 Series
 - ◆ AC Line Monitor
 - ◆ Unknown Polarity DC Sensor
 - ◆ Telephone Line Interface
- FOD817 Series
 - ◆ Power Supply Regulators
 - ◆ Digital Logic Inputs
 - ◆ Microprocessor Inputs

MARKING DIAGRAM

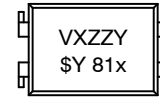

| | |
|-----|-------------------------|
| V | = VDE Mark |
| X | = One Digit Year Code |
| ZZ | = Two Digit Work Week |
| Y | = Assembly Package Code |
| \$Y | = Logo |
| 81x | = Specific Device Code |
| | x = 4 or 7 |

ORDERING INFORMATION

See detailed ordering and shipping information on page 8 of this data sheet.

FOD814, FOD817

FUNCTIONAL BLOCK DIAGRAM

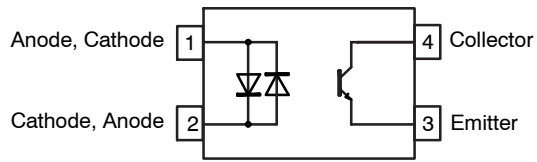

Figure 1. Schematic – FOD814

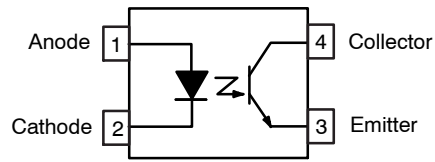

Figure 2. Schematic – FOD817

SAFETY AND INSULATION RATINGS

| Parameter | Characteristics | |
|---|------------------------|-------|
| Installation Classifications per DIN VDE 0110/1.89 Table 1, For Rated Mains Voltage | < 150 V _{RMS} | I–IV |
| | < 300 V _{RMS} | I–III |
| Climatic Classification | 30/110/21 | |
| Pollution Degree (DIN VDE 0110/1.89) | 2 | |
| Comparative Tracking Index | 175 | |

| Symbol | Parameter | Value | Unit |
|-----------------------|--|--------------------|-------------------|
| V _{PR} | Input-to-Output Test Voltage, Method A, V _{IORM} × 1.6 = V _{PR} , Type and Sample Test with t _m = 10 s, Partial Discharge < 5 pC | 1360 | V _{peak} |
| | Input-to-Output Test Voltage, Method B, V _{IORM} × 1.875 = V _{PR} , 100% Production Test with t _m = 1 s, Partial Discharge < 5 pC | 1594 | |
| V _{IORM} | Maximum Working Insulation Voltage | 850 | |
| V _{IOTM} | Highest Allowable Over-Voltage | 8000 | |
| | External Creepage | ≥ 7 | mm |
| | External Clearance | ≥ 7 | |
| | External Clearance (for Option W, 0.4" Lead Spacing) | ≥ 10 | |
| DTI | Distance Through Insulation (Insulation Thickness) | ≥ 0.4 | |
| T _S | Case Temperature (Note 1) | 175 | °C |
| I _{S,INPUT} | Input Current (Note 1) | 400 | mA |
| P _{S,OUTPUT} | Output Power (Note 1) | 700 | mW |
| R _{IO} | Insulation Resistance at T _S , V _{IO} = 500 V (Note 1) | > 10 ¹¹ | Ω |

As per DIN EN/IEC 60747–5–5, this optocoupler is suitable for “safe electrical insulation” only within the safety limit data. Compliance with the safety ratings shall be ensured by means of protective circuits.

1. Safety limit values – maximum values allowed in the event of a failure.

ABSOLUTE MAXIMUM RATINGS T_A = 25°C unless otherwise specified.

| Symbol | Parameter | Value | | Unit |
|--------|-----------|--------|--------|------|
| | | FOD814 | FOD817 | |

TOTAL DEVICE

| | | | | |
|------------------|-------------------------------------|--------------|-------------|------|
| T _{STG} | Storage Temperature | –55 to +150 | | °C |
| T _{OPR} | Operating Temperature | –55 to +105 | –55 to +110 | |
| T _J | Junction Temperature | –55 to +125 | | |
| T _{SOL} | Lead Solder Temperature | 260 for 10 s | | |
| θ _{JC} | Junction-to-Case Thermal Resistance | 210 | | °C/W |
| P _{TOT} | Total Device Power Dissipation | 200 | | mW |

FOD814, FOD817

ABSOLUTE MAXIMUM RATINGS $T_A = 25^\circ\text{C}$ unless otherwise specified. (continued)

| Symbol | Parameter | Value | | Unit |
|----------------|----------------------------------|----------|--------|----------------------|
| | | FOD814 | FOD817 | |
| EMITTER | | | | |
| I_F | Continuous Forward Current | ± 50 | 50 | mA |
| V_R | Reverse Voltage | | 6 | V |
| P_D | Power Dissipation | 70 | | mW |
| | Derate Above 100°C | 1.7 | | mW/ $^\circ\text{C}$ |

DETECTOR

| | | | | |
|-----------|---------------------------------|-----|--|----------------------|
| V_{CE0} | Collector–Emitter Voltage | 70 | | V |
| V_{EC0} | Emitter–Collector Voltage | 6 | | |
| I_C | Continuous Collector Current | 50 | | mA |
| P_C | Collector Power Dissipation | 150 | | mW |
| | Derate Above 90°C | 2.9 | | mW/ $^\circ\text{C}$ |

Stresses exceeding those listed in the Maximum Ratings table may damage the device. If any of these limits are exceeded, device functionality should not be assumed, damage may occur and reliability may be affected.

ELECTRICAL CHARACTERISTICS $T_A = 25^\circ\text{C}$ unless otherwise specified.

INDIVIDUAL COMPONENT CHARACTERISTICS

| Symbol | Parameter | Device | Test Conditions | Min | Typ | Max | Unit |
|----------------|----------------------|--------|---------------------------|-----|-----|-----|---------------|
| Emitter | | | | | | | |
| V_F | Forward Voltage | FOD814 | $I_F = \pm 20\text{ mA}$ | – | 1.2 | 1.4 | V |
| | | FOD817 | $I_F = 20\text{ mA}$ | – | 1.2 | 1.4 | |
| I_R | Reverse Current | FOD817 | $V_R = 4.0\text{ V}$ | – | – | 10 | μA |
| C_t | Terminal Capacitance | FOD814 | $V = 0, f = 1\text{ kHz}$ | – | 50 | 250 | pF |
| | | FOD817 | | – | 30 | 250 | |

Detector

| | | | | | | | |
|------------|-------------------------------------|--------|--|----|---|-----|----|
| I_{CE0} | Collector Dark Current | FOD814 | $V_{CE} = 20\text{ V}, I_F = 0$ | – | – | 100 | nA |
| | | FOD817 | | – | – | 100 | |
| BV_{CE0} | Collector–Emitter Breakdown Voltage | FOD814 | $I_C = 0.1\text{ mA}, I_F = 0$ | 70 | – | – | V |
| | | FOD817 | | 70 | – | – | |
| BV_{EC0} | Emitter–Collector Breakdown Voltage | FOD814 | $I_E = 10\text{ }\mu\text{A}, I_F = 0$ | 6 | – | – | V |
| | | FOD817 | | 6 | – | – | |

DC TRANSFER CHARACTERISTICS

| Symbol | Parameter | Device | Test Conditions | Min | Typ | Max | Unit |
|---------------|--------------------------------------|---------|--|-----|-----|-----|------|
| CTR | Current Transfer Ratio (Note 2) | FOD814 | $I_F = \pm 1\text{ mA}, V_{CE} = 5\text{ V}$ | 20 | – | 300 | % |
| | | FOD814A | | 50 | – | 150 | |
| | | FOD817 | $I_F = 5\text{ mA}, V_{CE} = 5\text{ V}$ | 50 | – | 600 | |
| | | FOD817A | | 80 | – | 160 | |
| | | FOD817B | | 130 | – | 260 | |
| | | FOD817C | | 200 | – | 400 | |
| | | FOD817D | | 300 | – | 600 | |
| $V_{CE(SAT)}$ | Collector–Emitter Saturation Voltage | FOD814 | $I_F = \pm 20\text{ mA}, I_C = 1\text{ mA}$ | – | 0.1 | 0.2 | V |
| | | FOD817 | $I_F = 20\text{ mA}, I_C = 1\text{ mA}$ | – | 0.1 | 0.2 | |

FOD814, FOD817

ELECTRICAL CHARACTERISTICS $T_A = 25^\circ\text{C}$ unless otherwise specified. (continued)

AC TRANSFER CHARACTERISTICS

| Symbol | Parameter | Device | Test Conditions | Min | Typ | Max | Unit |
|--------|----------------------|-------------------|---|-----|-----|-----|---------------|
| f_c | Cut-Off Frequency | FOD814 | $V_{CE} = 5\text{ V}$, $I_C = 2\text{ mA}$, $R_L = 100\ \Omega$, -3 dB | 15 | 80 | – | kHz |
| t_r | Response Time (Rise) | FOD814, FOD817 | $V_{CE} = 2\text{ V}$, $I_C = 2\text{ mA}$, $R_L = 100\ \Omega$ (Note 3) | – | 4 | 18 | μs |
| t_f | Response Time (Fall) | FOD814, FOD817 | | – | 3 | 18 | |

ISOLATION CHARACTERISTICS

| Symbol | Parameter | Device | Test Conditions | Min | Typ | Max | Unit |
|-----------|--|-------------------|--|--------------------|--------------------|-----|----------------|
| V_{ISO} | Input-Output Isolation Voltage (Note 4) | FOD814, FOD817 | $f = 60\text{ Hz}$, $t = 1\text{ min}$, $I_{I-O} \leq 2\ \mu\text{A}$ | 5000 | – | – | $V_{AC_{RMS}}$ |
| R_{ISO} | Isolation Resistance | FOD814, FOD817 | $V_{I-O} = 500\text{ V}_{DC}$ | 5×10^{10} | 1×10^{11} | – | Ω |
| C_{ISO} | Isolation Capacitance | FOD814, FOD817 | $V_{I-O} = 0$, $f = 1\text{ MHz}$ | – | 0.6 | 1.0 | pf |

Product parametric performance is indicated in the Electrical Characteristics for the listed test conditions, unless otherwise noted. Product performance may not be indicated by the Electrical Characteristics if operated under different conditions.

2. Current Transfer Ratio (CTR) = $I_C / I_F \times 100\%$
3. For test circuit setup and waveforms, refer to page 5.
4. For this test, Pins 1 and 2 are common, and Pins 3 and 4 are common.

TYPICAL ELECTRICAL/OPTICAL CHARACTERISTICS CURVES

$T_A = 25^\circ\text{C}$ unless otherwise specified.

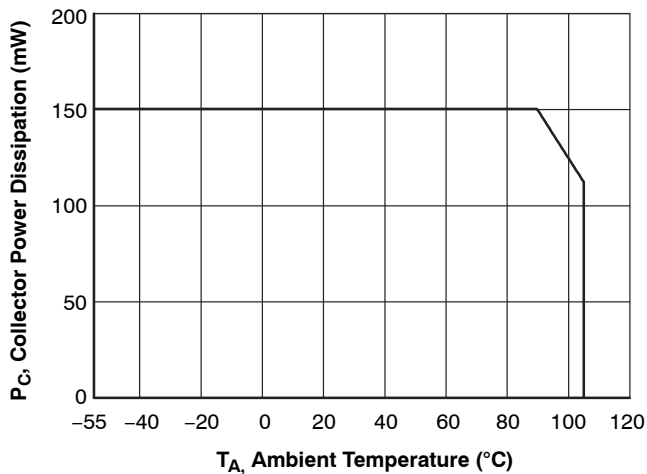

Figure 3. Collector Power Dissipation vs. Ambient Temperature (FOD814)

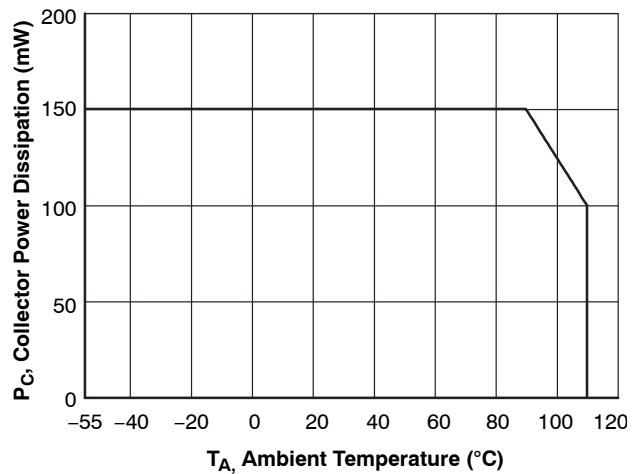

Figure 4. Collector Power Dissipation vs. Ambient Temperature (FOD817)

FOD814, FOD817

TYPICAL ELECTRICAL/OPTICAL CHARACTERISTICS CURVES

$T_A = 25^\circ\text{C}$ unless otherwise specified. (continued)

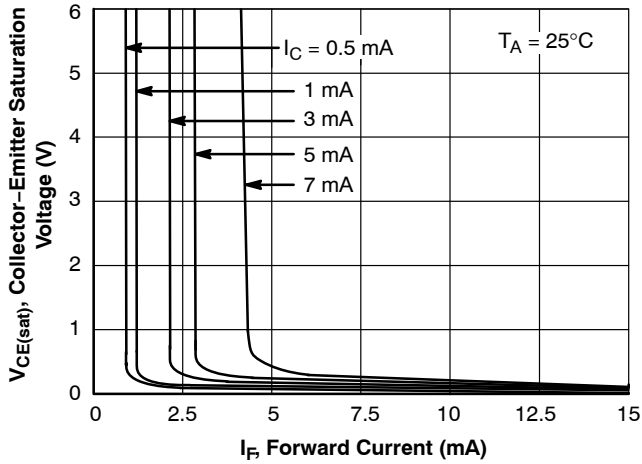

Figure 5. Collector-Emitter Saturation Voltage vs. Forward Current

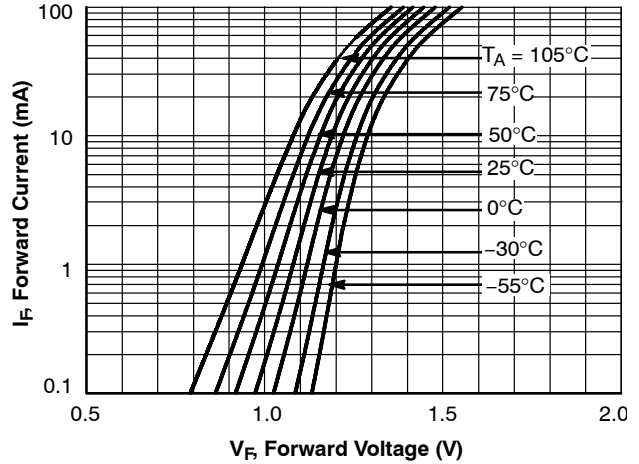

Figure 6. Forward Current vs. Forward Voltage (FOD814)

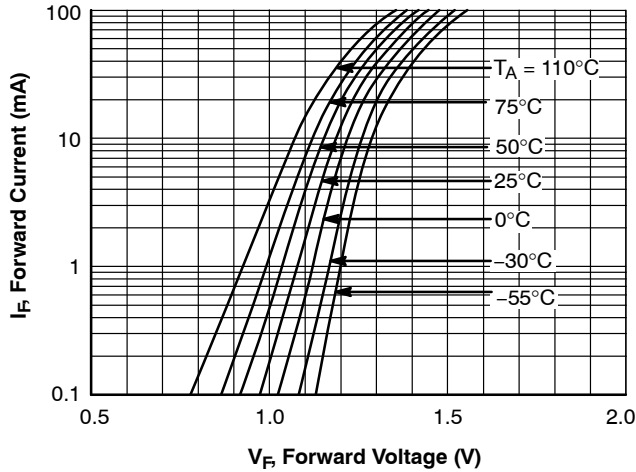

Figure 7. Forward Current vs. Forward Voltage (FOD817)

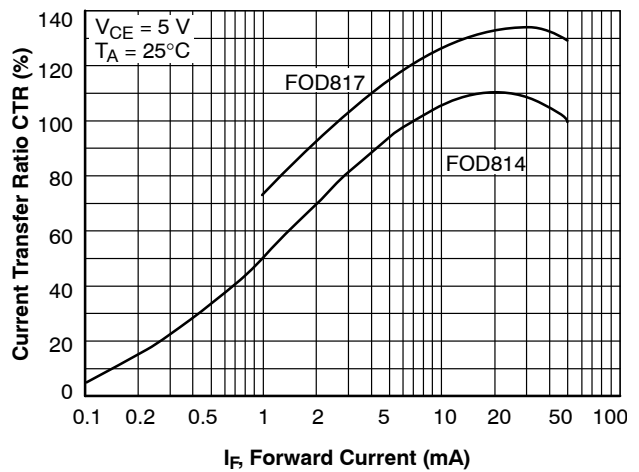

Figure 8. Current Transfer Ratio vs. Forward Current

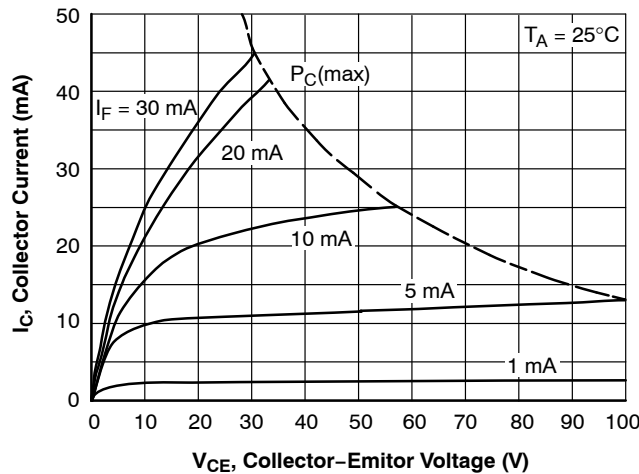

Figure 9. Collector Current vs. Collector-Emitter Voltage (FOD814)

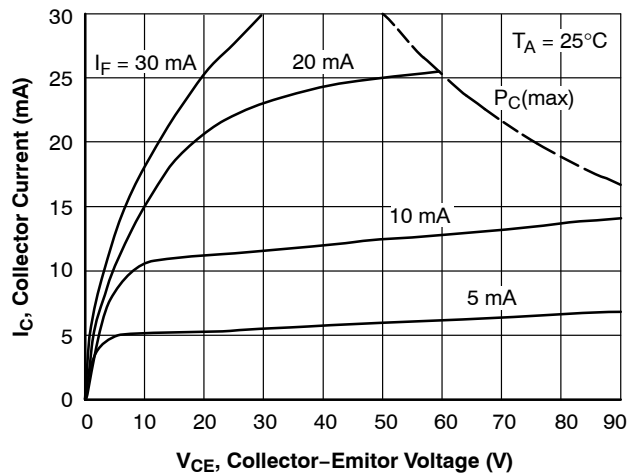

Figure 10. Collector Current vs. Collector-Emitter Voltage (FOD817)

FOD814, FOD817

TYPICAL ELECTRICAL/OPTICAL CHARACTERISTICS CURVES

$T_A = 25^\circ\text{C}$ unless otherwise specified. (continued)

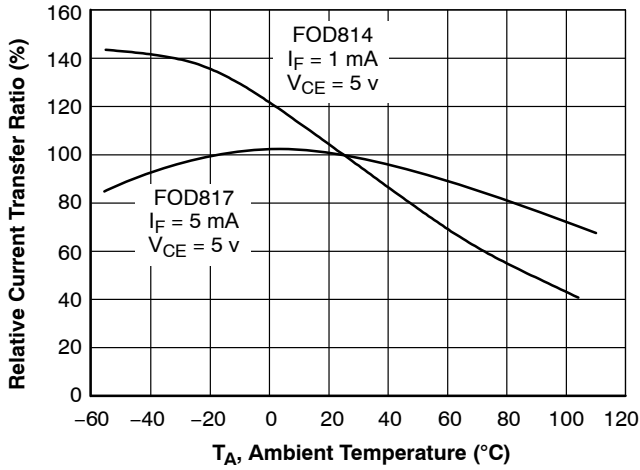

Figure 11. Relative Current Transfer Ratio vs. Ambient Temperature

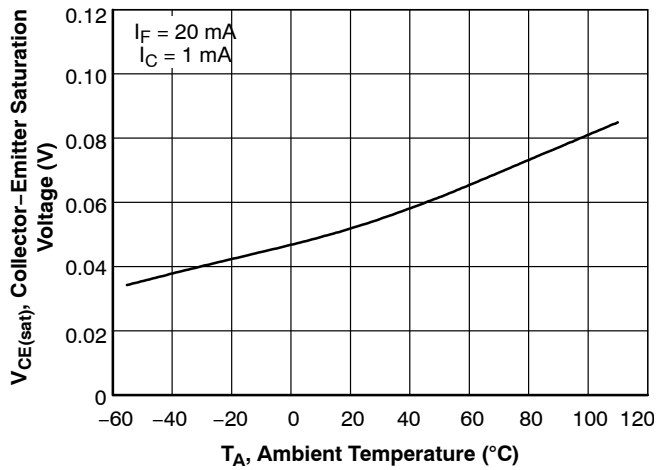

Figure 12. Collector-Emitter Saturation Voltage vs. Ambient Temperature

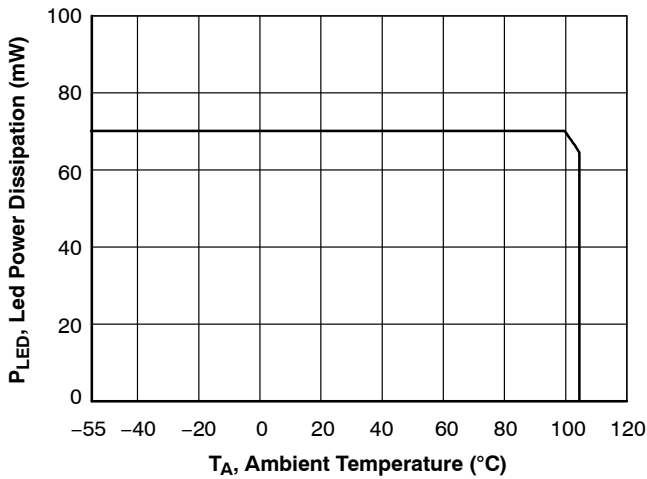

Figure 13. Led Power Dissipation vs. Ambient Temperature (FOD814)

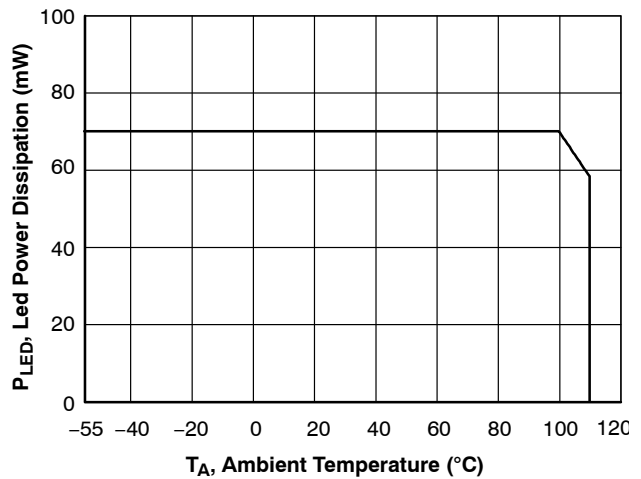

Figure 14. Led Power Dissipation vs. Ambient Temperature (FOD817)

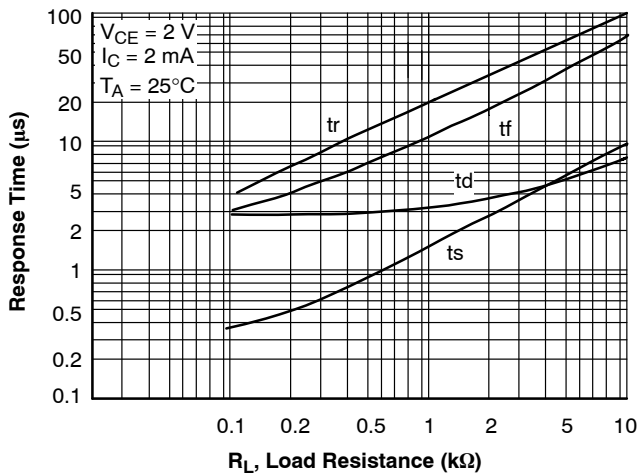

Figure 15. Response Time vs. Load Resistance

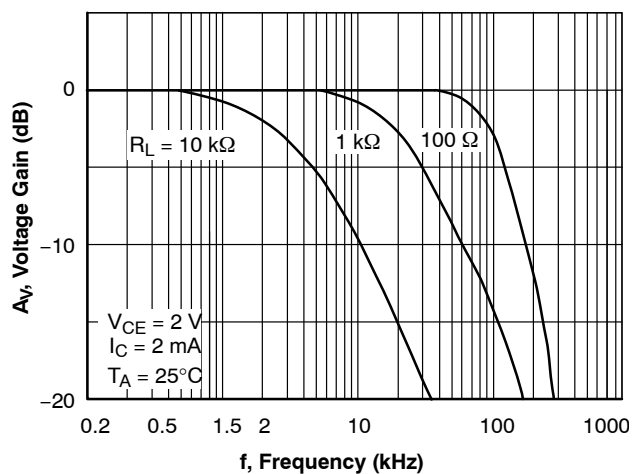

Figure 16. Frequency Response

FOD814, FOD817

TYPICAL ELECTRICAL/OPTICAL CHARACTERISTICS CURVES

$T_A = 25^\circ\text{C}$ unless otherwise specified. (continued)

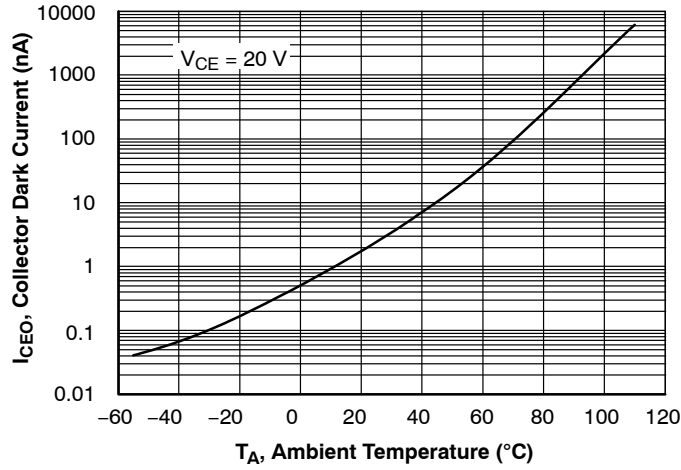

Figure 17. Collector Dark Current vs. Ambient Temperature

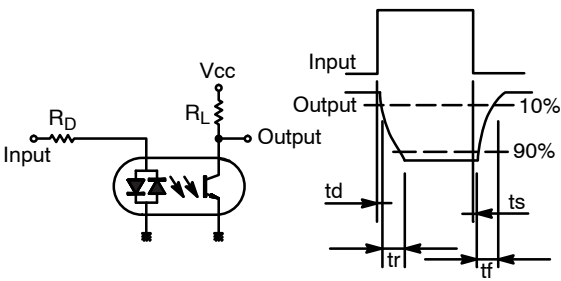

Figure 18. Test Circuit for Response Time

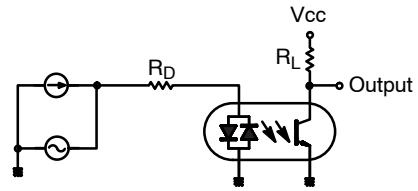

Figure 19. Test Circuit for Frequency Response

FOD814, FOD817

REFLOW PROFILE

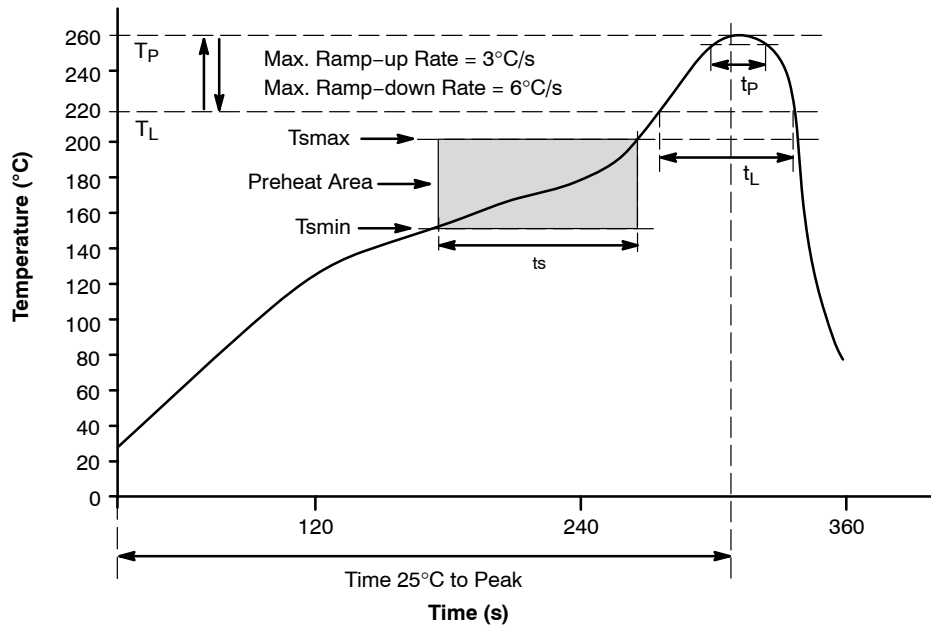

Figure 20. Reflow Profile

REFLOW PROFILE

| Profile Feature | Pb-Free Assembly Profile |
|--|--------------------------|
| Temperature Min. (T_{min}) | 150°C |
| Temperature Max. (T_{max}) | 200°C |
| Time (t_s) from (T_{min} to T_{max}) | 60–120 s |
| Ramp-up Rate (t_L to t_P) | 3°C/s max. |
| Liquidous Temperature (T_L) | 217°C |
| Time (t_L) Maintained Above (T_L) | 60–150 s |
| Peak Body Package Temperature | 260°C +0°C / -5°C |
| Time (t_P) within 5°C of 260°C | 30 s |
| Ramp-down Rate (T_P to T_L) | 6°C/s max. |
| Time 25°C to Peak Temperature | 8 min max. |

ORDERING INFORMATION

| Part Number | Package | Shipping [†] |
|-------------|--|--------------------------------------|
| FOD817X | DIP 4-Pin | Tube (100 units per tube) |
| FOD817XS | SMT 4-Pin (Lead Bend) | Tube (100 units per tube) |
| FOD817XSD | SMT 4-Pin (Lead Bend) | Tape and Reel (1,000 units per reel) |
| FOD817X300 | DIP 4-Pin, DIN EN/IEC60747-5-5 option | Tube (100 units per tube) |
| FOD817X3S | SMT 4-Pin (Lead Bend), DIN EN/IEC60747-5-5 option | Tube (100 units per tube) |
| FOD817X3SD | SMT 4-Pin (Lead Bend), DIN EN/IEC60747-5-5 option | Tape and Reel (1,000 units per reel) |
| FOD817X300W | DIP 4-Pin, 0.4" Lead Spacing, DIN EN/IEC60747-5-5 option | Tube (100 units per tube) |

[†]For information on tape and reel specifications, including part orientation and tape sizes, please refer to our Tape and Reel Packaging Specifications Brochure, BRD8011/D.

NOTE: The product orderable part number system listed in this table also applies to the FOD814 products. "X" denotes the Current Transfer Ratio (CTR) options.

MECHANICAL CASE OUTLINE
PACKAGE DIMENSIONS



PDIP4 4.6x6.5, 2.54P
CASE 646CA
ISSUE O

DATE 31 JUL 2016

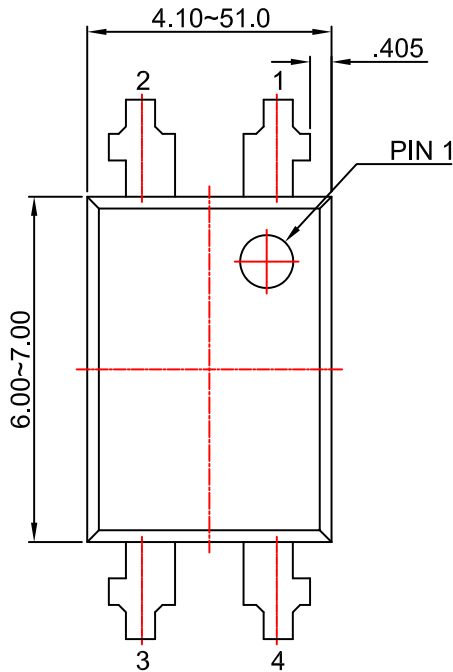

NOTES:

- A) NO STANDARD APPLIES TO THIS PACKAGE.
- B) ALL DIMENSIONS ARE IN MILLIMETERS.
- C) DIMENSIONS ARE EXCLUSIVE OF BURRS, MOLD FLASH, AND TIE BAR EXTRUSION

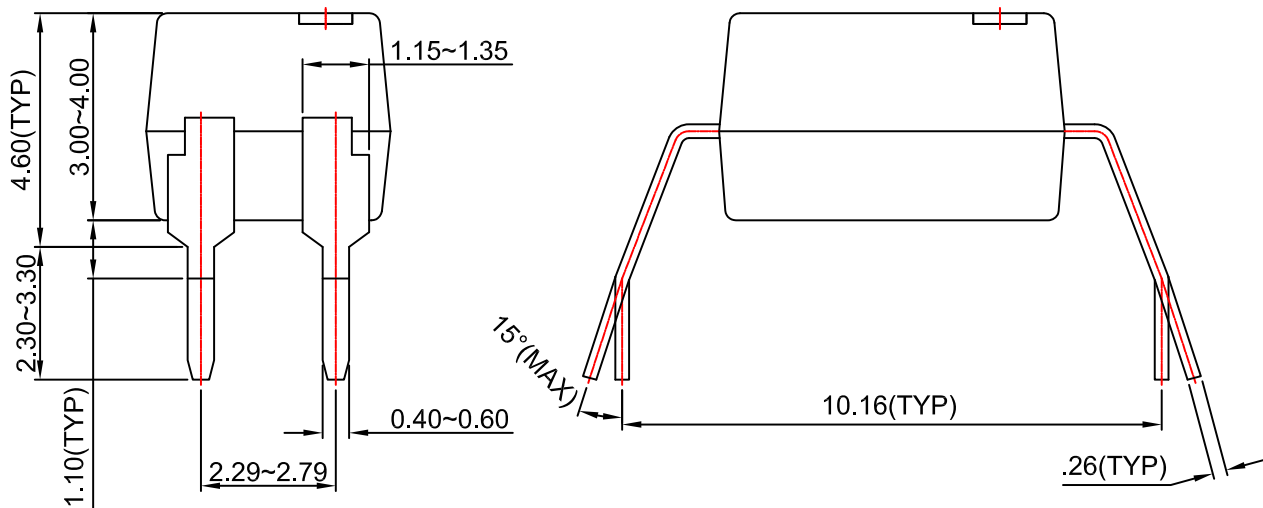

| | | |
|-------------------------|-----------------------------|---|
| DOCUMENT NUMBER: | 98AON13453G | Electronic versions are uncontrolled except when accessed directly from the Document Repository. Printed versions are uncontrolled except when stamped "CONTROLLED COPY" in red. |
| DESCRIPTION: | PDIP4 4.6X6.5, 2.54P | PAGE 1 OF 1 |

onsemi and **ONSEMI** are trademarks of Semiconductor Components Industries, LLC dba **onsemi** or its subsidiaries in the United States and/or other countries. **onsemi** reserves the right to make changes without further notice to any products herein. **onsemi** makes no warranty, representation or guarantee regarding the suitability of its products for any particular purpose, nor does **onsemi** assume any liability arising out of the application or use of any product or circuit, and specifically disclaims any and all liability, including without limitation special, consequential or incidental damages. **onsemi** does not convey any license under its patent rights nor the rights of others.

MECHANICAL CASE OUTLINE
PACKAGE DIMENSIONS



PDIP4 4.6x6.5, 2.54P
CASE 646CD
ISSUE O

DATE 31 JUL 2016

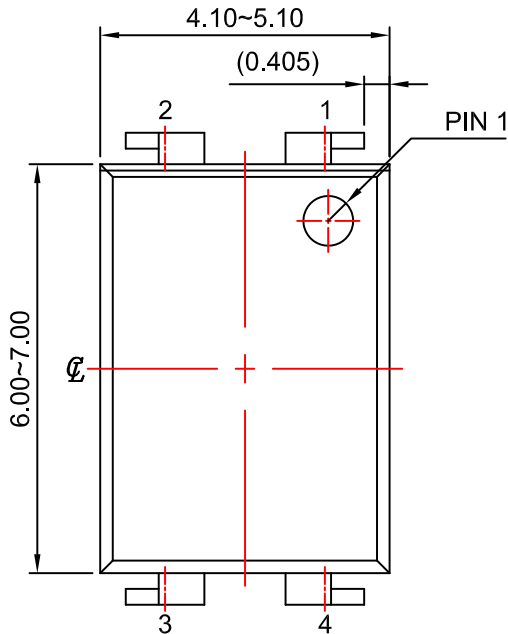

NOTES:

- A) NO STANDARD APPLIES TO THIS PACKAGE.
- B) ALL DIMENSIONS ARE IN MILLIMETERS.
- C) DIMENSIONS ARE EXCLUSIVE OF BURRS, MOLD FLASH, AND TIE BAR EXTRUSION

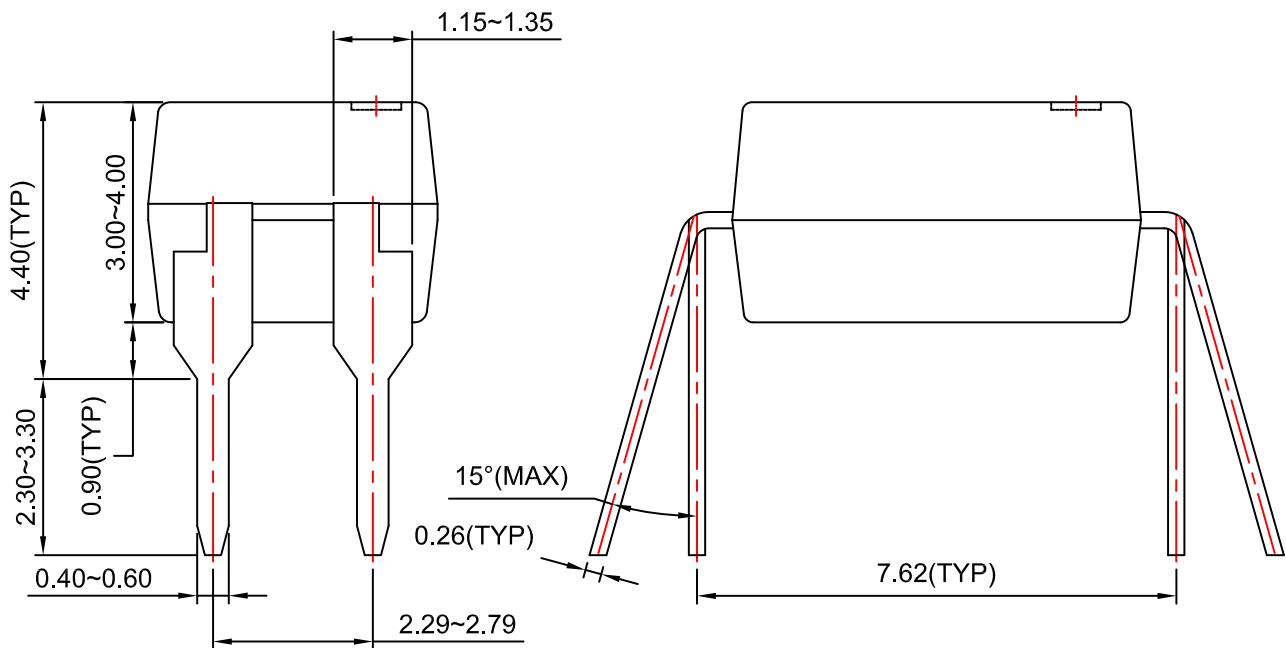

| | | |
|-------------------------|-----------------------------|---|
| DOCUMENT NUMBER: | 98AON13452G | Electronic versions are uncontrolled except when accessed directly from the Document Repository. Printed versions are uncontrolled except when stamped "CONTROLLED COPY" in red. |
| DESCRIPTION: | PDIP4 4.6X6.5, 2.54P | PAGE 1 OF 1 |

onsemi and ONSEMI are trademarks of Semiconductor Components Industries, LLC dba onsemi or its subsidiaries in the United States and/or other countries. onsemi reserves the right to make changes without further notice to any products herein. onsemi makes no warranty, representation or guarantee regarding the suitability of its products for any particular purpose, nor does onsemi assume any liability arising out of the application or use of any product or circuit, and specifically disclaims any and all liability, including without limitation special, consequential or incidental damages. onsemi does not convey any license under its patent rights nor the rights of others.

MECHANICAL CASE OUTLINE

PACKAGE DIMENSIONS

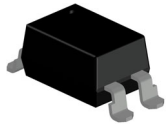

PDIP4 4.60x6.50x3.85, 2.54P
CASE 709AH
ISSUE B

DATE 06 JUL 2023

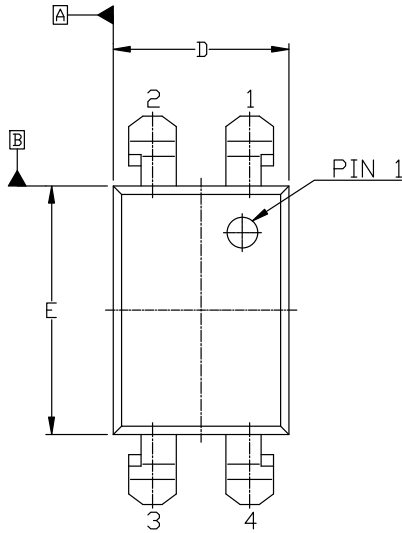

TOP VIEW

NOTES:

1. DIMENSIONING AND TOLERANCING PER ASME Y14.5M, 1994.
2. CONTROLLING DIMENSION: MILLIMETERS.
3. DIMENSIONS ARE EXCLUSIVE OF BURRS, MOLD FLASH, AND TIE BAR EXTRUSION.
4. DRAWING FILENAME AND REVISION: MKT-N04Crev2.

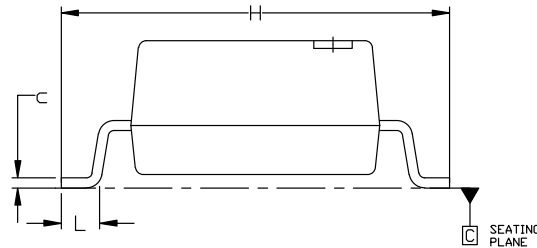

END VIEW

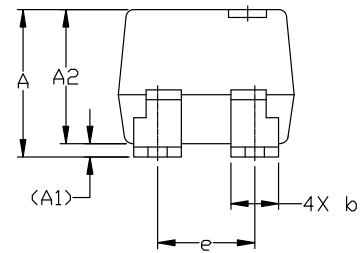

SIDE VIEW

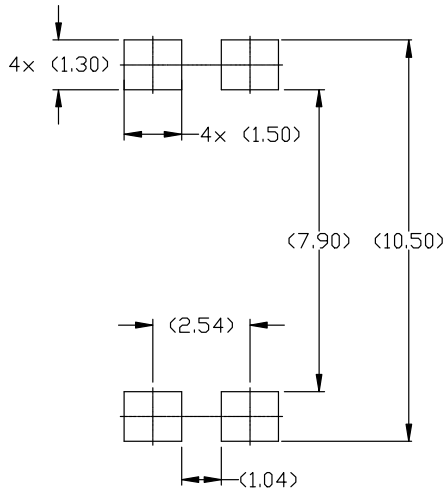

LAND PATTERN RECOMMENDATION

| DIM | MILLIMETERS | | |
|-----|-------------|-------|-------|
| | MIN. | NOM. | MAX. |
| A | 3.85 (TYP) | | |
| A1 | 0.35 (REF) | | |
| A2 | 3.00 | 3.50 | 4.00 |
| b | 1.15 | 1.25 | 1.35 |
| c | 0.26 (REF) | | |
| D | 4.10 | 4.60 | 5.10 |
| E | 6.00 | 6.50 | 7.00 |
| e | 2.29 | 2.54 | 2.79 |
| H | 9.86 | 10.16 | 10.46 |
| L | 0.75 | --- | 1.25 |

* For additional information on our Pb-Free strategy and soldering details, please download the ON Semiconductor Soldering and Mounting Techniques Reference Manual, SOLDERM/D.

| | | |
|-------------------------|------------------------------------|--|
| DOCUMENT NUMBER: | 98AON13454G | Electronic versions are uncontrolled except when accessed directly from the Document Repository. Printed versions are uncontrolled except when stamped "CONTROLLED COPY" in red. |
| DESCRIPTION: | PDIP4 4.60x6.50x3.85, 2.54P | PAGE 1 OF 1 |

onsemi and ONSEMI are trademarks of Semiconductor Components Industries, LLC dba onsemi or its subsidiaries in the United States and/or other countries. onsemi reserves the right to make changes without further notice to any products herein. onsemi makes no warranty, representation or guarantee regarding the suitability of its products for any particular purpose, nor does onsemi assume any liability arising out of the application or use of any product or circuit, and specifically disclaims any and all liability, including without limitation special, consequential or incidental damages. onsemi does not convey any license under its patent rights nor the rights of others.

onsemi, **Onsemi**, and other names, marks, and brands are registered and/or common law trademarks of Semiconductor Components Industries, LLC dba "**onsemi**" or its affiliates and/or subsidiaries in the United States and/or other countries. **onsemi** owns the rights to a number of patents, trademarks, copyrights, trade secrets, and other intellectual property. A listing of **onsemi**'s product/patent coverage may be accessed at www.onsemi.com/site/pdf/Patent-Marking.pdf. **onsemi** reserves the right to make changes at any time to any products or information herein, without notice. The information herein is provided "as-is" and **onsemi** makes no warranty, representation or guarantee regarding the accuracy of the information, product features, availability, functionality, or suitability of its products for any particular purpose, nor does **onsemi** assume any liability arising out of the application or use of any product or circuit, and specifically disclaims any and all liability, including without limitation special, consequential or incidental damages. Buyer is responsible for its products and applications using **onsemi** products, including compliance with all laws, regulations and safety requirements or standards, regardless of any support or applications information provided by **onsemi**. "Typical" parameters which may be provided in **onsemi** data sheets and/or specifications can and do vary in different applications and actual performance may vary over time. All operating parameters, including "Typicals" must be validated for each customer application by customer's technical experts. **onsemi** does not convey any license under any of its intellectual property rights nor the rights of others. **onsemi** products are not designed, intended, or authorized for use as a critical component in life support systems or any FDA Class 3 medical devices or medical devices with a same or similar classification in a foreign jurisdiction or any devices intended for implantation in the human body. Should Buyer purchase or use **onsemi** products for any such unintended or unauthorized application, Buyer shall indemnify and hold **onsemi** and its officers, employees, subsidiaries, affiliates, and distributors harmless against all claims, costs, damages, and expenses, and reasonable attorney fees arising out of, directly or indirectly, any claim of personal injury or death associated with such unintended or unauthorized use, even if such claim alleges that **onsemi** was negligent regarding the design or manufacture of the part. **onsemi** is an Equal Opportunity/Affirmative Action Employer. This literature is subject to all applicable copyright laws and is not for resale in any manner.

ADDITIONAL INFORMATION

TECHNICAL PUBLICATIONS:

Technical Library: www.onsemi.com/design/resources/technical-documentation
onsemi Website: www.onsemi.com

ONLINE SUPPORT: www.onsemi.com/support

For additional information, please contact your local Sales Representative at www.onsemi.com/support/sales