

# MOSFET - Power, Single N-Channel, D<sup>2</sup>PAK

**650 V, 82 mΩ, 40 A**

## NVB082N65S3F

### Description

SUPERFET<sup>®</sup> III MOSFET is ON Semiconductor’s brand–new high voltage super–junction (SJ) MOSFET family that is utilizing charge balance technology for outstanding low on–resistance and lower gate charge performance. This advanced technology is tailored to minimize conduction loss, provide superior switching performance, and withstand extreme dv/dt rate.

Consequently, SUPERFET III MOSFET is very suitable for the various power system for miniaturization and higher efficiency. SUPERFET III FRFET<sup>®</sup> MOSFET’s optimized reverse recovery performance of body diode can remove additional component and improve system reliability.

### Features

- 700 V @ T<sub>J</sub> = 150°C
- Typ. R<sub>DS(on)</sub> = 64 mΩ
- Ultra Low Gate Charge (Typ. Q<sub>g</sub> = 81 nC)
- Low Effective Output Capacitance (Typ. C<sub>oss(eff.)</sub> = 722 pF)
- 100% Avalanche Tested
- Qualified with AEC–Q101
- These Devices are Pb–Free and are RoHS Compliant

### Typical Applications

- Automotive On Board Charger
- Automotive DC/DC Converter for HEV

V <sub>(BR)DSS</sub>	R <sub>DS(ON)</sub> MAX	I <sub>D</sub> MAX
650 V	82 mΩ @ 10 V	40 A

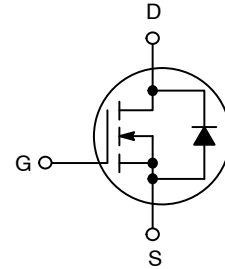

N-CHANNEL MOSFET

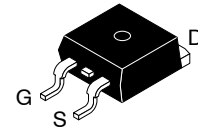

D<sup>2</sup>PAK–3  
 TO–263  
 CASE 418AJ

### MARKING DIAGRAM

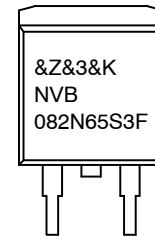

- &Z = Assembly Plant Code
- &3 = Data Code (Year & Week)
- &K = Lot
- NVB082N65S3F = Specific Device Code

### ORDERING INFORMATION

See detailed ordering and shipping information on page 7 of this data sheet.

# NVB082N65S3F

**Table 1. ABSOLUTE MAXIMUM RATINGS** ( $T_C = 25^\circ\text{C}$  unless otherwise stated)

Symbol	Parameter		Value	Unit
$V_{DSS}$	Drain-to-Source Voltage		650	V
$V_{GS}$	Gate-to-Source Voltage	- DC	$\pm 30$	V
		- AC ( $f > 1$ Hz)	$\pm 30$	
$I_D$	Drain Current	- Continuous ( $T_C = 25^\circ\text{C}$ )	40	A
		- Continuous ( $T_C = 100^\circ\text{C}$ )	25.5	
$I_{DM}$	Drain Current	- Pulsed (Note 1)	100	W
$E_{AS}$	Single Pulse Avalanche Energy (Note 2)		510	mJ
$I_{AS}$	Avalanche Current		4.8	A
$E_{AR}$	Repeated Avalanche Energy (Note 1)		3.13	mJ
dv/dt	MOSFET dv/dt		100	V/ns
	Peak Diode Recovery dv/dt (Note 3)		50	
$P_D$	Power Dissipation	$T_C = 25^\circ\text{C}$	313	W
		- Derate Above $25^\circ\text{C}$	2.5	W/ $^\circ\text{C}$
$T_J, T_{stg}$	Operating Junction and Storage Temperature		-55 to 150	$^\circ\text{C}$
$T_L$	Maximum Lead Temperature for Soldering, 1/8" from Case for 5 Seconds		300	$^\circ\text{C}$

Stresses exceeding those listed in the Maximum Ratings table may damage the device. If any of these limits are exceeded, device functionality should not be assumed, damage may occur and reliability may be affected.

1. Repetitive rating: pulse-width limited by maximum junction temperature.
2.  $I_{AS} = 4.8$  A,  $R_G = 25$   $\Omega$ , starting  $T_J = 25^\circ\text{C}$ .
3.  $ISD \leq 20$  A,  $di/dt \leq 200$  A/\_s,  $V_{DD} \leq 400$  V, starting  $T_C = 25^\circ\text{C}$ .

**Table 2. THERMAL RESISTANCE RATINGS**

Symbol	Parameter	Max	Unit
$R_{\theta JC}$	Thermal Resistance, Junction-to-Case, Max.	0.40	$^\circ\text{C}/\text{W}$
$R_{\theta JA}$	Thermal Resistance, Junction-to-Ambient, Max.	40	

# NVB082N65S3F

## ELECTRICAL CHARACTERISTICS ( $T_C = 25^\circ\text{C}$ unless otherwise noted)

Symbol	Parameter	Test Conditions	Min	Typ	Max	Unit
--------	-----------	-----------------	-----	-----	-----	------

### OFF CHARACTERISTICS

$BV_{DSS}$	Drain-to-Source Breakdown Voltage	$V_{GS} = 0\text{ V}, I_D = 1\text{ mA}, T_J = 25^\circ\text{C}$	650	-	-	V
		$V_{GS} = 0\text{ V}, I_D = 10\text{ mA}, T_J = 150^\circ\text{C}$	700	-	-	V
$\Delta BV_{DSS}/\Delta T_J$	Breakdown Voltage Temperature Coefficient	$I_D = 20\text{ mA}$ , Referenced to $25^\circ\text{C}$	-	0.7	-	V/ $^\circ\text{C}$
$I_{DSS}$	Zero Gate Voltage Drain Current	$V_{DS} = 650\text{ V}, V_{GS} = 0\text{ V}$	-	-	10	$\mu\text{A}$
		$V_{DS} = 520\text{ V}, T_C = 125^\circ\text{C}$	-	175	-	$\mu\text{A}$
$I_{GSS}$	Gate-to-Body Leakage Current	$V_{DS} = 0\text{ V}, V_{GS} = \pm 30\text{ V}$	-	-	$\pm 100$	nA

### ON CHARACTERISTICS

$V_{GS(th)}$	Gate Threshold Voltage	$V_{GS} = V_{DS}, I_D = 1\text{ mA}$	3.0	-	5.0	V
$R_{DS(on)}$	Static Drain-to-Source On Resistance	$V_{GS} = 10\text{ V}, I_D = 20\text{ A}$	-	64	82	m $\Omega$
$g_{FS}$	Forward Transconductance	$V_{GS} = 20\text{ V}, I_D = 20\text{ A}$	-	24	-	S

### DYNAMIC CHARACTERISTICS

$C_{iss}$	Input Capacitance	$V_{DS} = 400\text{ V}, V_{GS} = 0\text{ V}, f = 1\text{ MHz}$	-	3410	-	pF
$C_{oss}$	Output Capacitance		-	70	-	pF
$C_{oss(eff.)}$	Effective Output Capacitance	$V_{DS} = 0\text{ to }400\text{ V}, V_{GS} = 0\text{ V}$	-	722	-	pF
$C_{oss(er.)}$	Energy Related Output Capacitance	$V_{DS} = 0\text{ to }400\text{ V}, V_{GS} = 0\text{ V}$	-	126	-	pF
$Q_{g(total)}$	Total Gate Charge at 10 V	$V_{DS} = 400\text{ V}, I_D = 20\text{ A},$ $V_{GS} = 10\text{ V}$ (Note 4)	-	81	-	nC
$Q_{gs}$	Gate-to-Source Gate Charge		-	24	-	nC
$Q_{gd}$	Gate-to-Drain "Miller" Charge		-	32	-	nC
ESR	Equivalent Series Resistance	$F = 1\text{ MHz}$	-	1.9	-	$\Omega$

### SWITCHING CHARACTERISTICS, $V_{GS} = 10\text{ V}$

$t_{d(on)}$	Turn-On Delay Time	$V_{DD} = 400\text{ V}, I_D = 20\text{ A},$ $V_{GS} = 10\text{ V}, R_G = 4.7\text{ }\Omega$ (Note 4)	-	31	-	ns
$t_r$	Rise Time		-	29	-	ns
$t_{d(off)}$	Turn-Off Delay Time		-	76	-	ns
$t_f$	Fall Time		-	16	-	ns

### SOURCE-DRAIN DIODE CHARACTERISTICS

$I_S$	Maximum Continuous Source-to-Drain Diode Forward Current	-	-	40	A	
$I_{SM}$	Maximum Pulsed Source-to-Drain Diode Forward Current	-	-	100	A	
$V_{SD}$	Source-to-Drain Diode Forward Voltage	$V_{GS} = 0\text{ V}, I_{SD} = 20\text{ A}$	-	-	1.3	V
$t_{rr}$	Reverse-Recovery Time	$V_{GS} = 0\text{ V}, I_{SD} = 20\text{ A},$ $di_F/dt = 100\text{ A}/\mu\text{s}$	-	108	-	ns
$Q_{rr}$	Reverse-Recovery Charge		-	410	-	nC

Product parametric performance is indicated in the Electrical Characteristics for the listed test conditions, unless otherwise noted. Product performance may not be indicated by the Electrical Characteristics if operated under different conditions.

4. Essentially independent of operating temperature typical characteristics.

TYPICAL CHARACTERISTICS

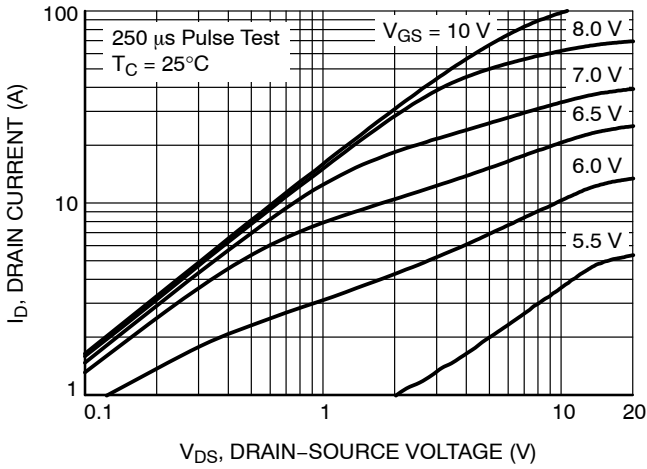

Figure 1. On-Region Characteristics  
25°C

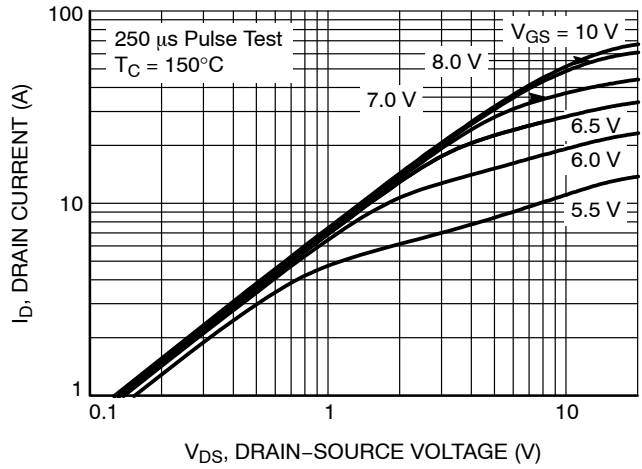

Figure 2. On-Region Characteristics  
150°C

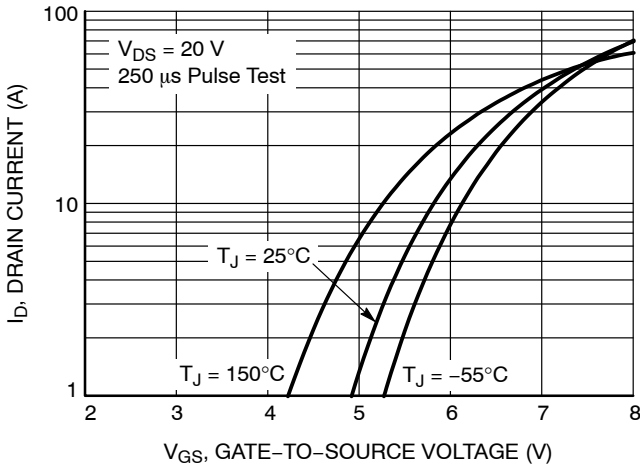

Figure 3. Transfer Characteristics

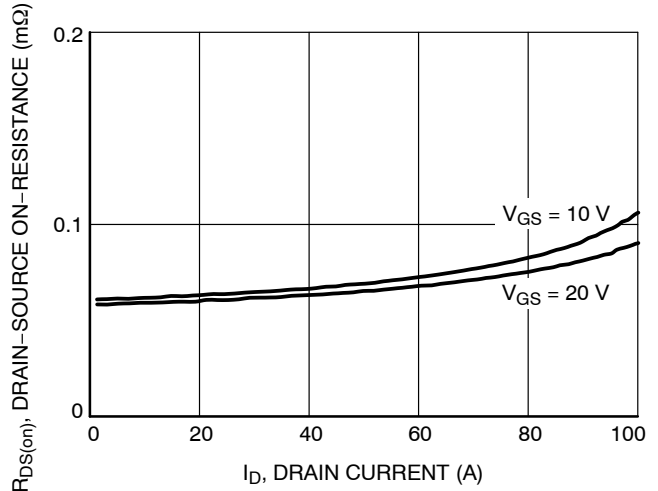

Figure 4. On-Resistance Variation vs. Drain Current and Gate Voltage

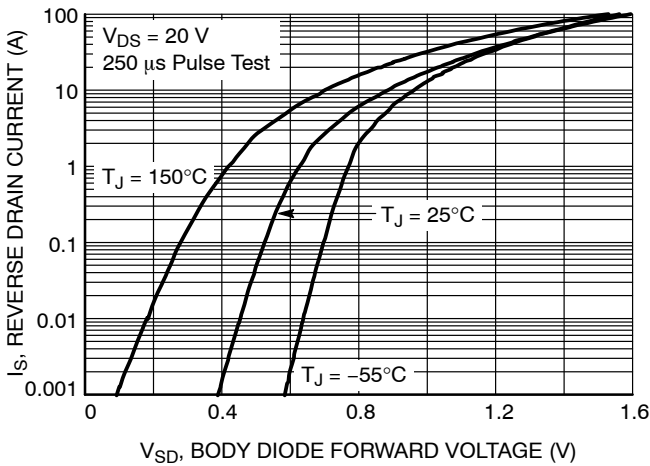

Figure 5. Body Diode Forward Voltage Variation vs. Source Current and Temperature

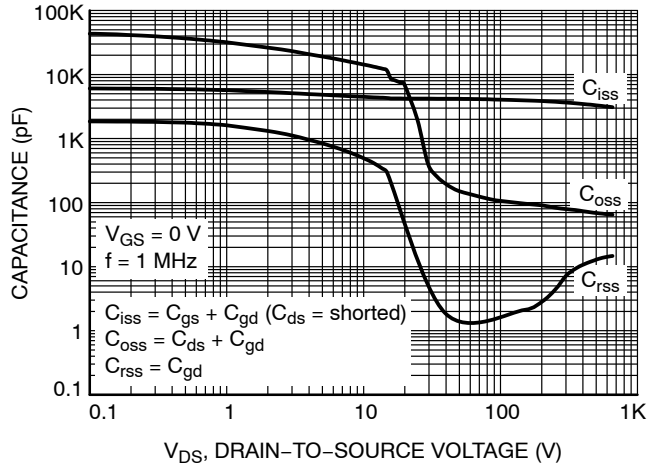

Figure 6. Capacitance Characteristics

TYPICAL CHARACTERISTICS

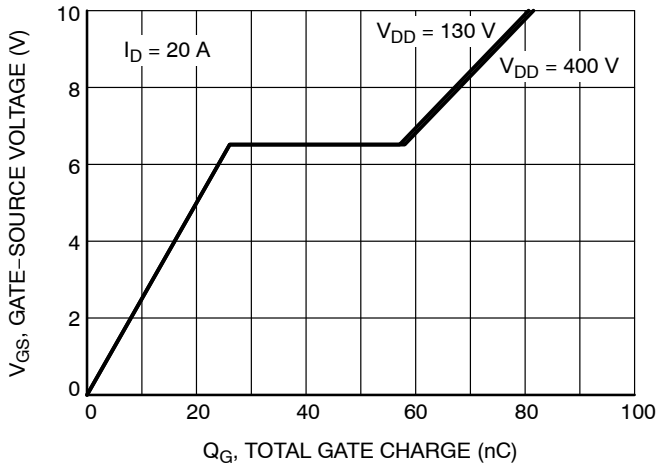

Figure 7. Gate Charge Characteristics

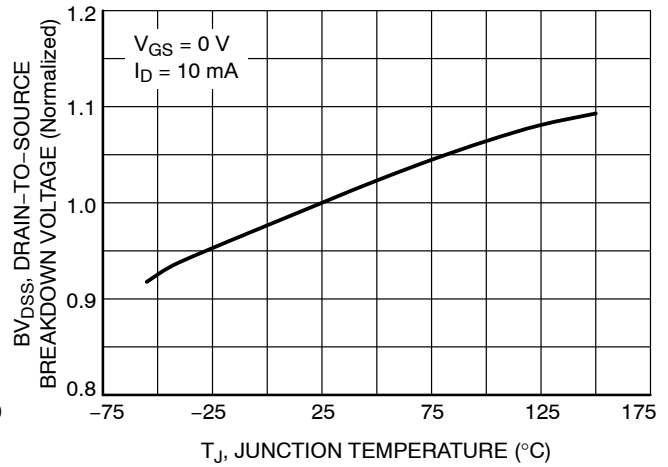

Figure 8. Breakdown Voltage Variation vs. Temperature

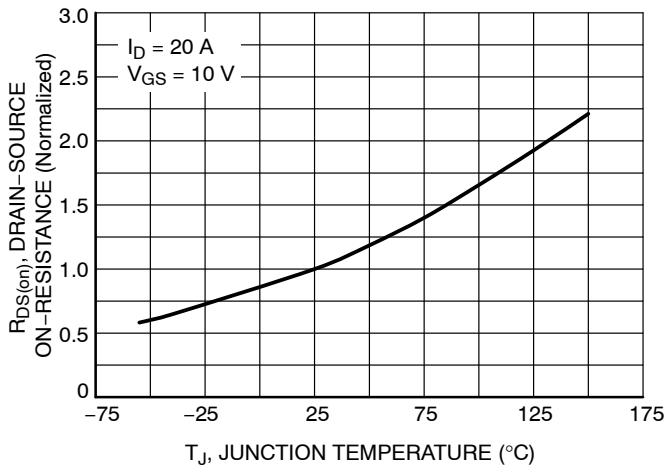

Figure 9. On-Resistance Variation vs. Temperature

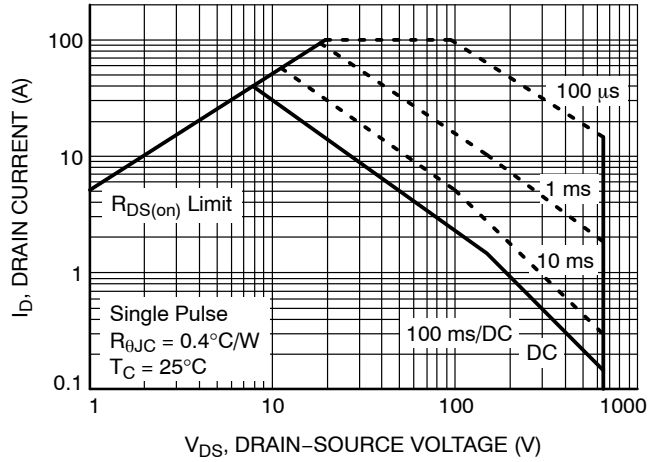

Figure 10. Maximum Safe Operating Area

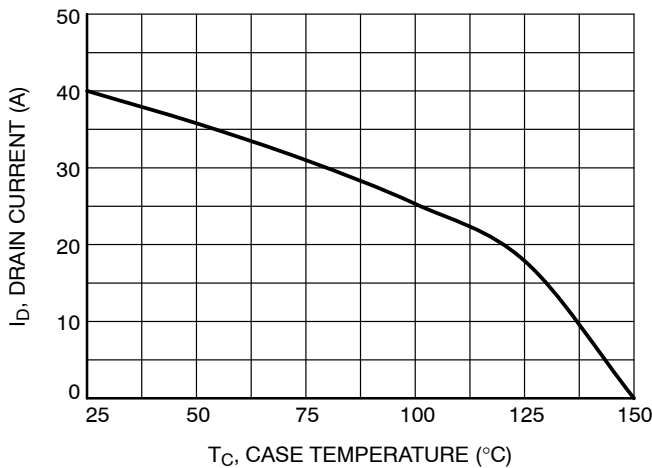

Figure 11. Maximum Drain Current vs. Case Temperature

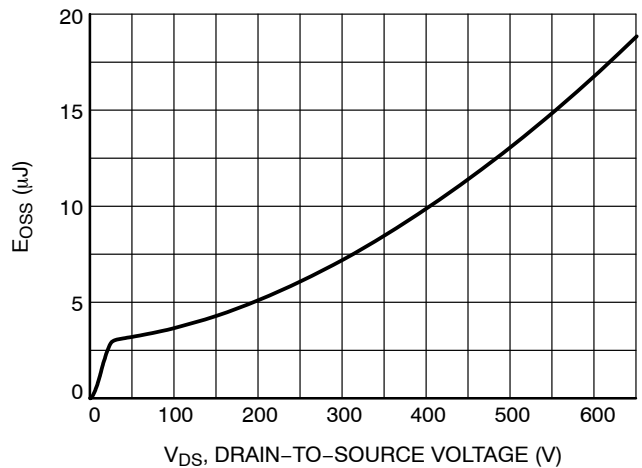
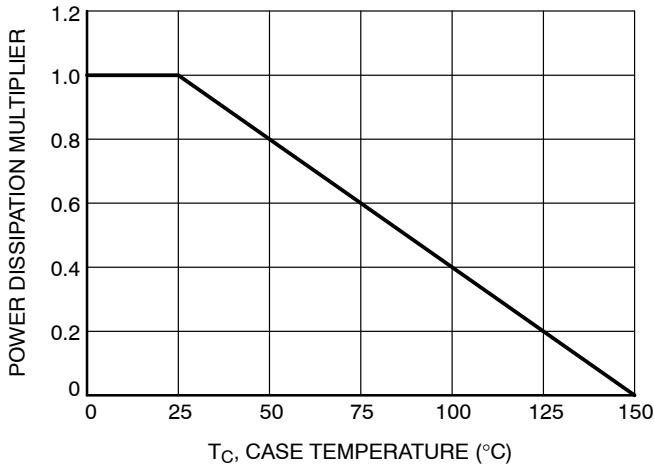

Figure 12. E<sub>OSS</sub> vs. Drain-to-Source Voltage

# NVB082N65S3F

## TYPICAL CHARACTERISTICS



**Figure 13. Normalized Power Dissipation vs. Case Temperature**

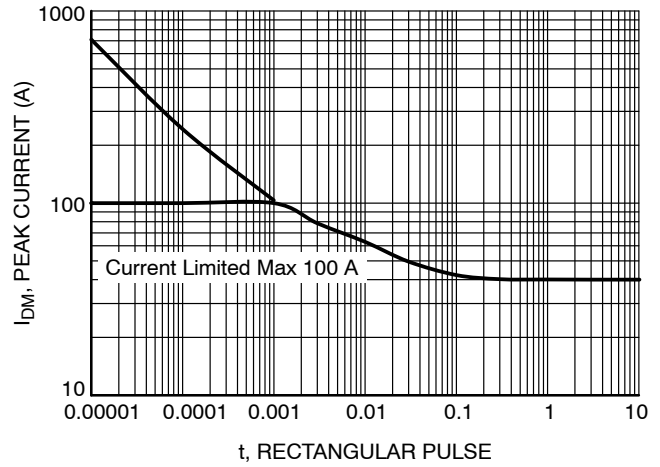

**Figure 14. Peak Current Capability**

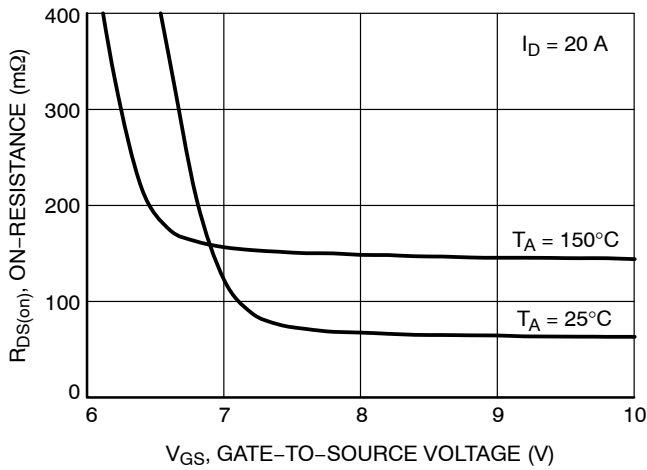

**Figure 15.  $R_{DS(on)}$  vs. Gate Voltage**

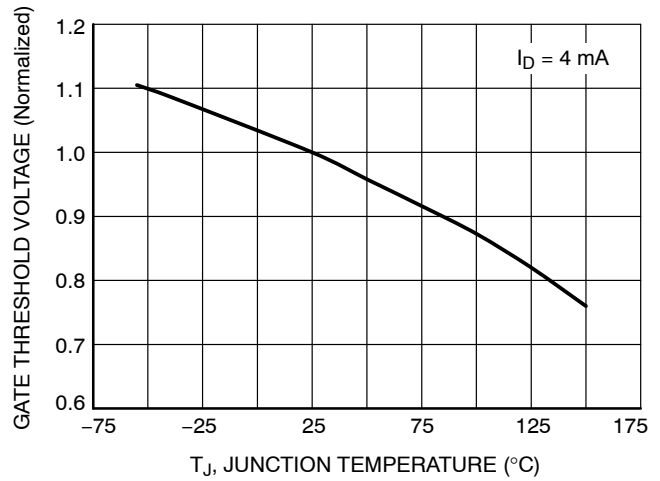

**Figure 16. Normalized Gate Threshold Voltage vs. Temperature**

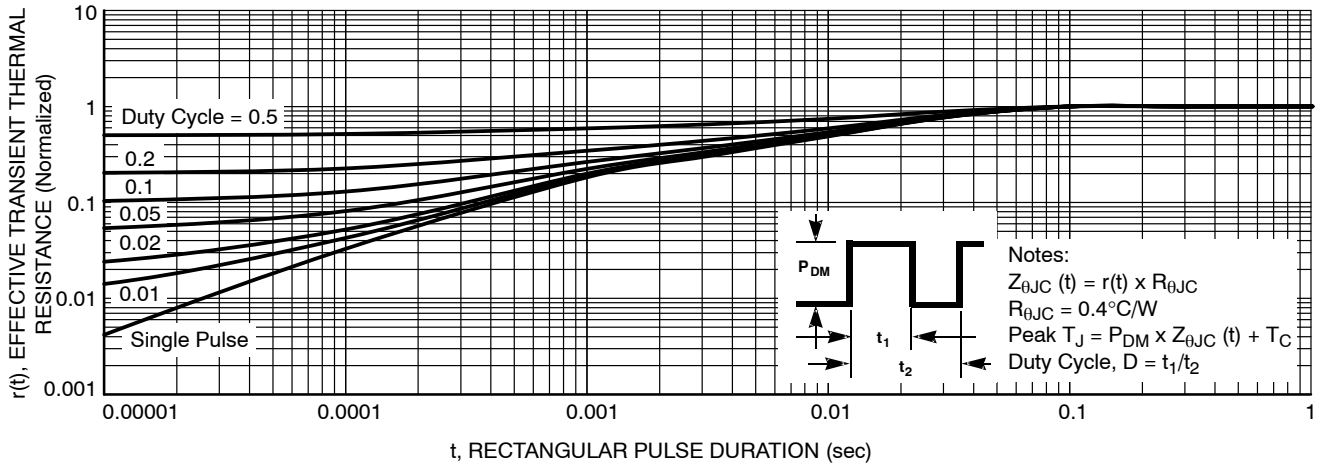

**Figure 17. Transient Thermal Response**

# NVB082N65S3F

## PACKAGE MARKING AND ORDERING INFORMATION

Part Number	Top Marking	Package	Packing Method	Reel Size	Tape Width	Quantity
NVB082N65S3F	NVB082N65S3F	D <sup>2</sup> PAK	Tape & Reel†	330 mm	24 mm	800 Units

†For information on tape and reel specifications, including part orientation and tape sizes, please refer to our Tape and Reel Packaging Specifications Brochure, [BRD8011/D](#).

SUPERFET and FRFET are registered trademarks of Semiconductor Components Industries, LLC.

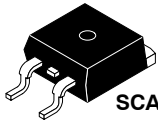

SCALE 1:1

D<sup>2</sup>PAK-3 (TO-263, 3-LEAD)  
CASE 418AJ  
ISSUE F

DATE 11 MAR 2021

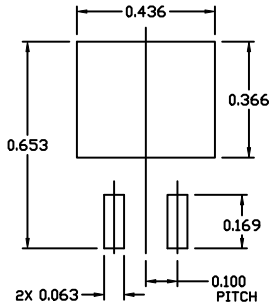

RECOMMENDED  
MOUNTING FOOTPRINT

For additional information on our Pb-free strategy and soldering details, please download the IN Semiconductor Soldering and Mounting Techniques Reference Manual, SOLDERM/D.

NOTES:

- DIMENSIONING AND TOLERANCING PER ASME Y14.5M, 2009.
- CONTROLLING DIMENSION: INCHES
- CHAMFER OPTIONAL.
- DIMENSIONS D AND E DO NOT INCLUDE MOLD FLASH. MOLD FLASH SHALL NOT EXCEED 0.005 PER SIDE. THESE DIMENSIONS ARE MEASURED AT THE OUTERMOST EXTREMES OF THE PLASTIC BODY AT DATUM H.
- THERMAL PAD CONTOUR IS OPTIONAL WITHIN DIMENSIONS E, L1, D1, AND E1.
- OPTIONAL MOLD FEATURE.
- ①, ② ... OPTIONAL CONSTRUCTION FEATURE CALL OUTS.

DIM	INCHES		MILLIMETERS	
	MIN.	MAX.	MIN.	MAX.
A	0.160	0.190	4.06	4.83
A1	0.000	0.010	0.00	0.25
b	0.020	0.039	0.51	0.99
c	0.012	0.029	0.30	0.74
c2	0.045	0.065	1.14	1.65
D	0.330	0.380	8.38	9.65
D1	0.260	---	6.60	---
E	0.380	0.420	9.65	10.67
E1	0.245	---	6.22	---
e	0.100 BSC	---	2.54 BSC	---
H	0.575	0.625	14.60	15.88
L	0.070	0.110	1.78	2.79
L1	---	0.066	---	1.68
L2	---	0.070	---	1.78
L3	0.010 BSC	---	0.25 BSC	---
M	0°	8°	0°	8°

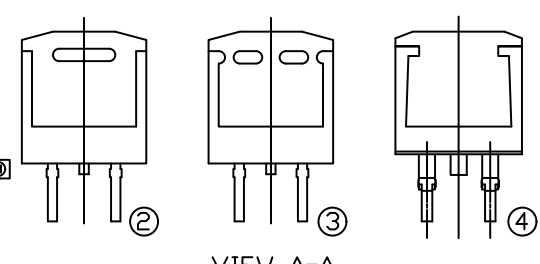
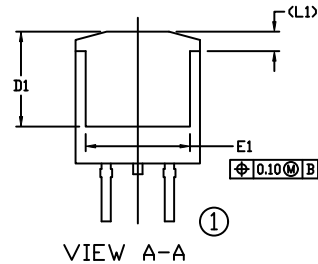
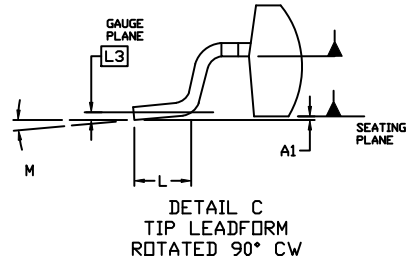
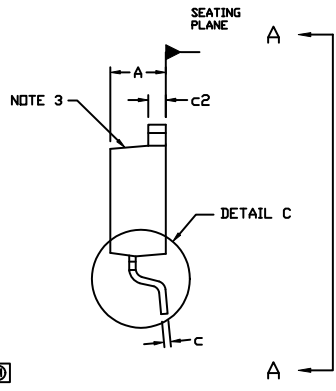
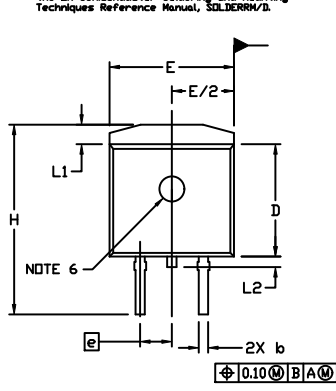

GENERIC MARKING DIAGRAMS\*

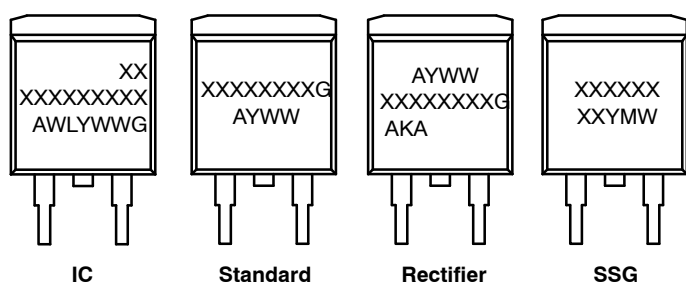

XXXXXX = Specific Device Code  
 A = Assembly Location  
 WL = Wafer Lot  
 Y = Year  
 WW = Work Week  
 W = Week Code (SSG)  
 M = Month Code (SSG)  
 G = Pb-Free Package  
 AKA = Polarity Indicator

\*This information is generic. Please refer to device data sheet for actual part marking. Pb-Free indicator, "G" or microdot "▪", may or may not be present. Some products may not follow the Generic Marking.

DOCUMENT NUMBER:	98AON56370E	Electronic versions are uncontrolled except when accessed directly from the Document Repository. Printed versions are uncontrolled except when stamped "CONTROLLED COPY" in red.
DESCRIPTION:	D <sup>2</sup> PAK-3 (TO-263, 3-LEAD)	PAGE 1 OF 1

onsemi and ONSEMI are trademarks of Semiconductor Components Industries, LLC dba onsemi or its subsidiaries in the United States and/or other countries. onsemi reserves the right to make changes without further notice to any products herein. onsemi makes no warranty, representation or guarantee regarding the suitability of its products for any particular purpose, nor does onsemi assume any liability arising out of the application or use of any product or circuit, and specifically disclaims any and all liability, including without limitation special, consequential or incidental damages. onsemi does not convey any license under its patent rights nor the rights of others.



**onsemi**, **Onsemi**, and other names, marks, and brands are registered and/or common law trademarks of Semiconductor Components Industries, LLC dba "**onsemi**" or its affiliates and/or subsidiaries in the United States and/or other countries. **onsemi** owns the rights to a number of patents, trademarks, copyrights, trade secrets, and other intellectual property. A listing of **onsemi**'s product/patent coverage may be accessed at [www.onsemi.com/site/pdf/Patent-Marking.pdf](http://www.onsemi.com/site/pdf/Patent-Marking.pdf). **onsemi** reserves the right to make changes at any time to any products or information herein, without notice. The information herein is provided "as-is" and **onsemi** makes no warranty, representation or guarantee regarding the accuracy of the information, product features, availability, functionality, or suitability of its products for any particular purpose, nor does **onsemi** assume any liability arising out of the application or use of any product or circuit, and specifically disclaims any and all liability, including without limitation special, consequential or incidental damages. Buyer is responsible for its products and applications using **onsemi** products, including compliance with all laws, regulations and safety requirements or standards, regardless of any support or applications information provided by **onsemi**. "Typical" parameters which may be provided in **onsemi** data sheets and/or specifications can and do vary in different applications and actual performance may vary over time. All operating parameters, including "Typicals" must be validated for each customer application by customer's technical experts. **onsemi** does not convey any license under any of its intellectual property rights nor the rights of others. **onsemi** products are not designed, intended, or authorized for use as a critical component in life support systems or any FDA Class 3 medical devices or medical devices with a same or similar classification in a foreign jurisdiction or any devices intended for implantation in the human body. Should Buyer purchase or use **onsemi** products for any such unintended or unauthorized application, Buyer shall indemnify and hold **onsemi** and its officers, employees, subsidiaries, affiliates, and distributors harmless against all claims, costs, damages, and expenses, and reasonable attorney fees arising out of, directly or indirectly, any claim of personal injury or death associated with such unintended or unauthorized use, even if such claim alleges that **onsemi** was negligent regarding the design or manufacture of the part. **onsemi** is an Equal Opportunity/Affirmative Action Employer. This literature is subject to all applicable copyright laws and is not for resale in any manner.

## ADDITIONAL INFORMATION

### TECHNICAL PUBLICATIONS:

Technical Library: [www.onsemi.com/design/resources/technical-documentation](http://www.onsemi.com/design/resources/technical-documentation)  
onsemi Website: [www.onsemi.com](http://www.onsemi.com)

### ONLINE SUPPORT: [www.onsemi.com/support](http://www.onsemi.com/support)

For additional information, please contact your local Sales Representative at [www.onsemi.com/support/sales](http://www.onsemi.com/support/sales)