

# NUS2401SNT1

## Integrated PNP/NPN Digital Transistors Array

This new option of integrated digital transistors is designed to replace a discrete solution array of three transistors and their external resistor bias network. BRTs (Bias Resistor Transistors) contain a single transistor with a monolithic bias network consisting of two resistors; a series base resistor and a base-emitter resistor. The BRT technology eliminates these individual components by integrating them into a single device, therefore the integration of three BRTs results in a significant reduction of both system cost and board space. This new device is packaged in the SC-74/Case 318F package which is designed for low power surface mount applications.

### Features

- Integrated Design
- Reduces Board Space and Components Count
- Simplifies Circuitry Design
- Offered in Surface Mount Package Technology (SC-74)
- Available in 3000 Unit Tape and Reel
- Pb-Free Package is Available

### Applications

- Audio Muting Applications
- Drive Circuits Applications
- Industrial: Small Appliances, Security Systems, Automated Test
- Consumer: TVs and VCRs, Stereo Receivers, CD Players, Cassette Recorders

**MAXIMUM RATINGS** (Maximum ratings are those values beyond which device damage can occur. Electrical Characteristics are not guaranteed over this range.)

Rating	Symbol	Value	Unit
Collector-Base Voltage	$V_{(BR)CBO}$	60	Vdc
Collector-Emitter Voltage	$V_{(BR)CEO}$	50	Vdc
Emitter-Base Voltage	$V_{(BR)EBO}$	7.0	Vdc
Collector Current - Continuous	$I_C$	200	mAdc

### THERMAL CHARACTERISTICS

Characteristic	Symbol	Max	Unit
Power Dissipation	$P_D$	350	mW
Junction Temperature	$T_J$	150	°C
Storage Temperature	$T_{stg}$	-55 to +150	°C

Stresses exceeding Maximum Ratings may damage the device. Maximum Ratings are stress ratings only. Functional operation above the Recommended Operating Conditions is not implied. Extended exposure to stresses above the Recommended Operating Conditions may affect device reliability.



**ON Semiconductor®**

<http://onsemi.com>

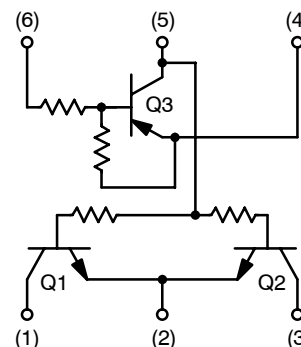

SC-74  
CASE 318F  
STYLE 4

### MARKING DIAGRAM

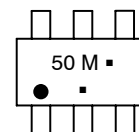

50 = Specific Device Code  
M = Date Code  
▪ = Pb-Free Package

(Note: Microdot may be in either location)

\*Date Code orientation may vary depending upon manufacturing location.

### ORDERING INFORMATION

Device	Package	Shipping†
NUS2401SNT1	SC-74	3000/Tape & Reel
NUS2401SNT1G	SC-74 (Pb-Free)	3000/Tape & Reel

†For information on tape and reel specifications, including part orientation and tape sizes, please refer to our Tape and Reel Packaging Specifications Brochure, BRD8011/D.

# NUS2401SNT1

## ELECTRICAL CHARACTERISTICS

(Unless otherwise noted:  $T_J = 25^\circ\text{C}$  for typical values, common for Q1, Q2, and Q3, – minus signed for Q3 (PNP) omitted.)

Characteristic	Symbol	Min	Typ	Max	Unit
<b>OFF CHARACTERISTICS</b>					
Collector–Base Cutoff Current ( $V_{CB} = 50\text{ V}$ , $I_E = 0$ )	$I_{CBO}$	–	–	100	nAdc
Collector–Emitter Cutoff Current ( $V_{CE} = 50\text{ V}$ , $I_B = 0$ )	$I_{CEO}$	–	–	500	nAdc
Emitter–Base Cutoff Current ( $V_{CE} = 6.0\text{ V}$ , $I_C = 0$ )	$I_{EBO}$	–	–	500	$\mu\text{A}$
	Q3	–	–	0.1	
	Q1, Q2	–	–		
Collector–Base Breakdown Voltage ( $I_C = 10\ \mu\text{A}$ , $I_E = 0$ )	$V_{(BR)CBO}$	50	–	–	V
Collector–Emitter Breakdown Voltage (Note 1) ( $I_C = 2.0\text{ mA}$ , $I_B = 0$ )	$V_{(BR)CEO}$	50	–	–	V

## ON CHARACTERISTICS (Note 1)

DC Current Gain	Q3	$h_{FE}$	35	60	–	
	Q1, Q2		150	350	–	
Collector–Emitter Saturation Voltage ( $I_C = 10\text{ mA}$ , $I_B = 0.3\text{ mA}$ )	Q3	$V_{CE(sat)}$	–	–	0.25	Vdc
( $I_C = 10\text{ mA}$ , $I_B = 1.0\text{ mA}$ )	Q1, Q2		–	–	0.25	
Output Voltage (on) ( $V_{CC} = 5.0\text{ V}$ , $V_B = 2.5\text{ V}$ , $R_L = 1.0\text{ k}\Omega$ )		$V_{OL}$	–	–	0.2	V
Output Voltage (off) ( $V_{CC} = 5.0\text{ V}$ , $V_B = 0.25\text{ V}$ , $R_L = 1.0\text{ k}\Omega$ )		$V_{OH}$	4.9	–	–	V
Input Resistor	Q3	R1	7.0	10	13	$\text{k}\Omega$
	Q1, Q2		0.13	0.175	0.22	
Resistor Ratio	Q3	R1/R2	–	1.0	–	
	Q1, Q2		–	$\infty$	–	

1. Pulse Test: Pulse Width < 300  $\mu\text{s}$ , Duty Cycle < 2%.

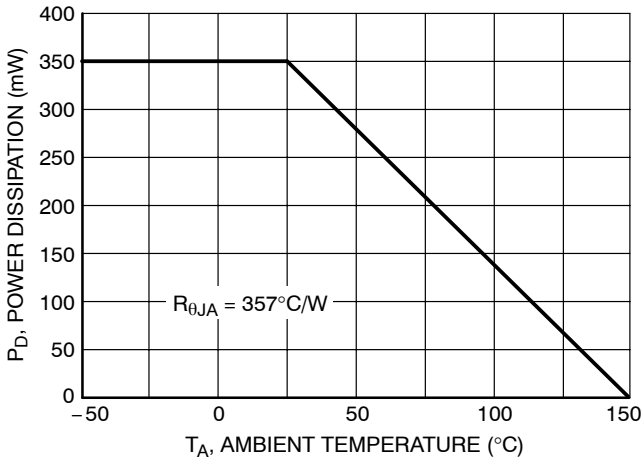

Figure 1. Derating Curve

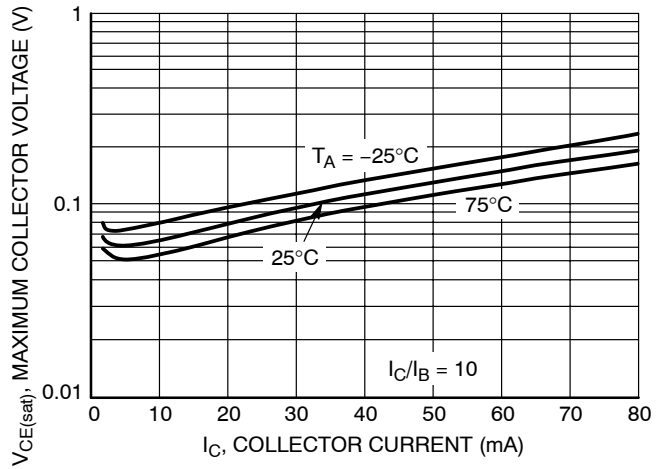

Figure 2. Maximum Collector Voltage versus Collector Current

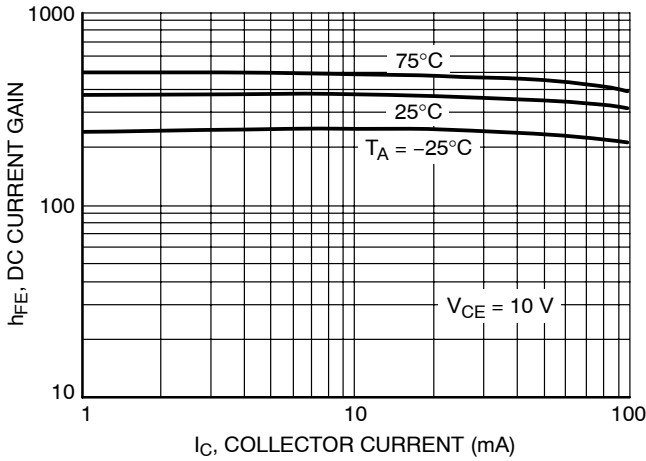

Figure 3. DC Current Gain

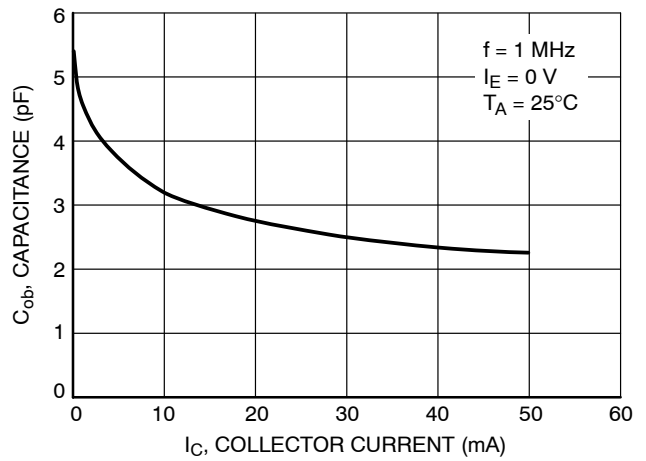

Figure 4. Output Capacitance

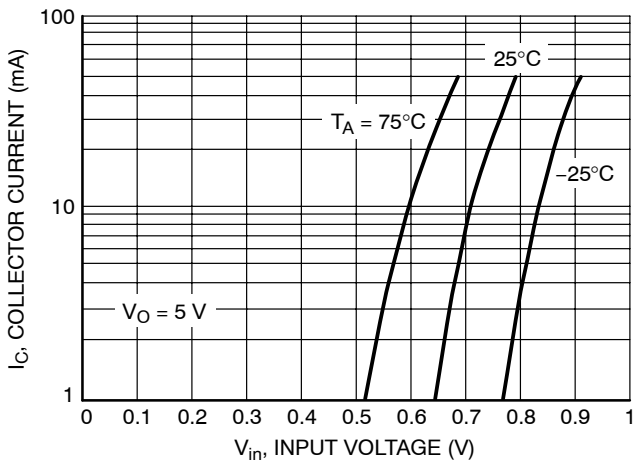

Figure 5. Output Current versus Input Voltage

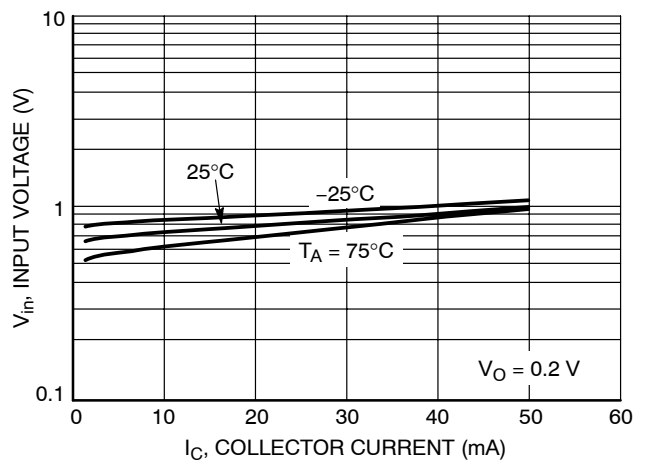

Figure 6. Input Voltage versus Output Current

# NUS2401SNT1

## TYPICAL ELECTRICAL CHARACTERISTICS – Q3 (PNP)

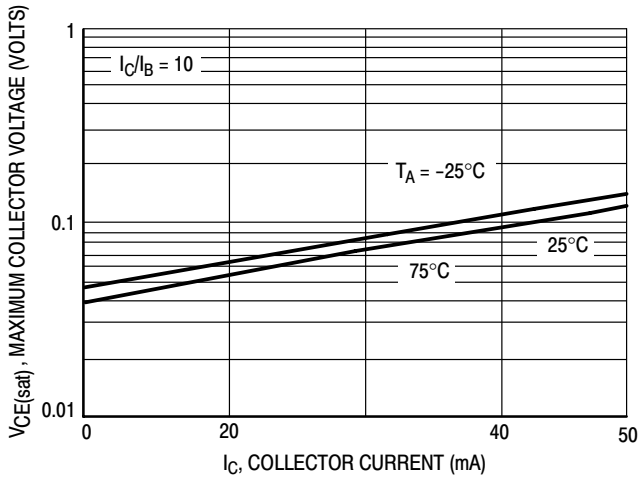

Figure 7.  $V_{CE(sat)}$  versus  $I_C$

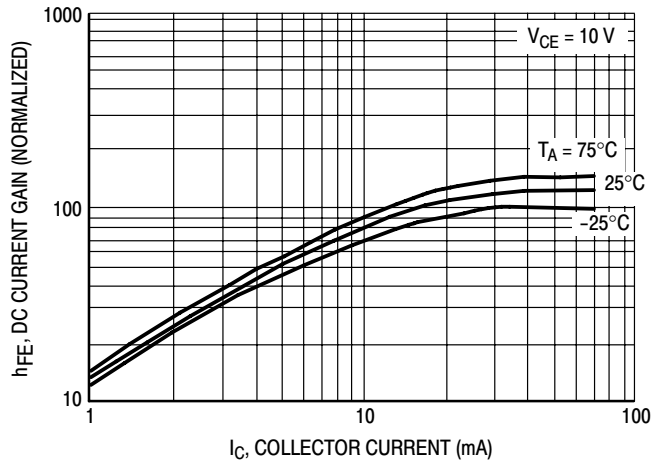

Figure 8. DC Current Gain

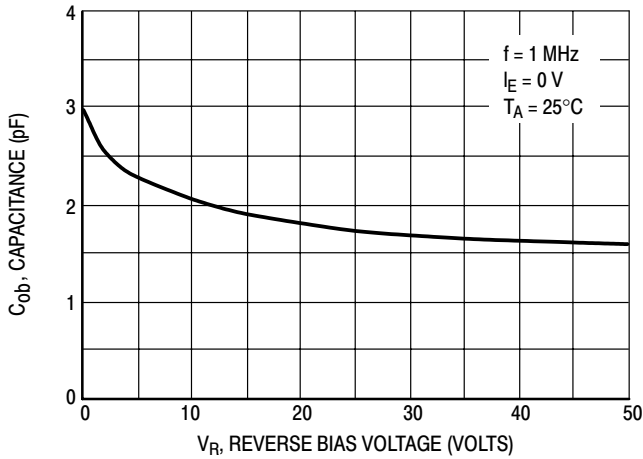

Figure 9. Output Capacitance

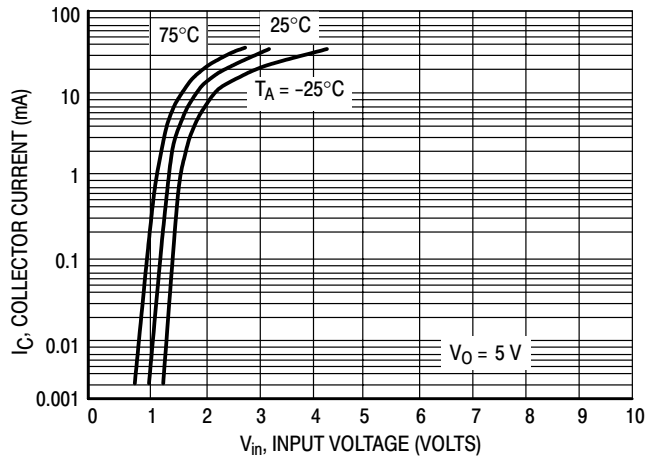

Figure 10. Output Current versus Input Voltage

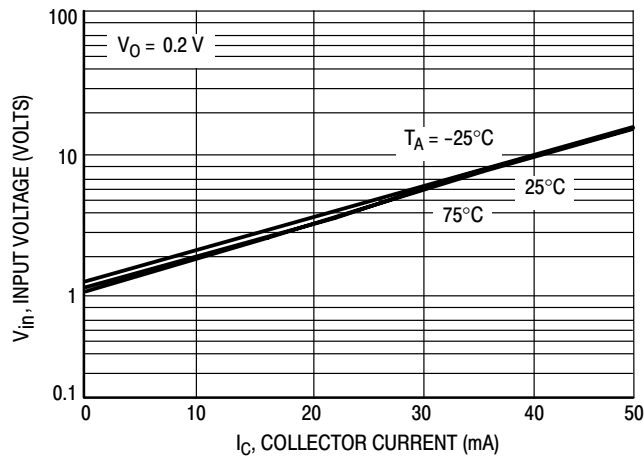

Figure 11. Input Voltage versus Output Current

# MECHANICAL CASE OUTLINE PACKAGE DIMENSIONS



SCALE 2:1

SC-74  
CASE 318F  
ISSUE P

DATE 07 OCT 2021

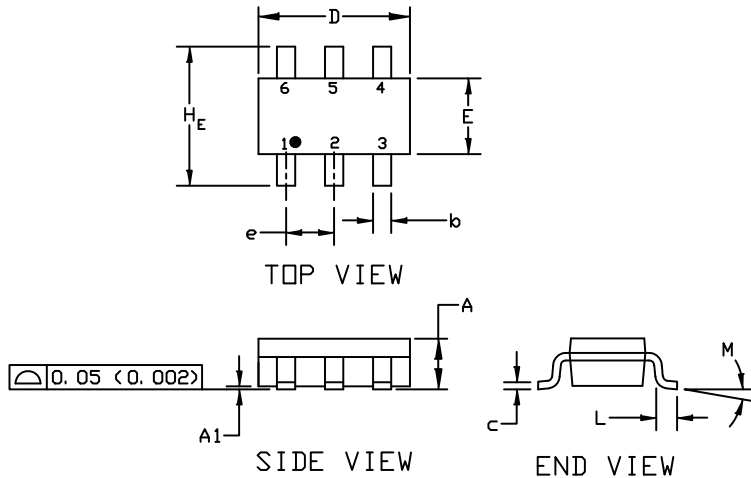

NOTES:

1. DIMENSIONING AND TOLERANCING PER ASME Y14.5M, 1994
2. CONTROLLING DIMENSION: INCHES
3. MAXIMUM LEAD THICKNESS INCLUDES LEAD FINISH THICKNESS. MINIMUM LEAD THICKNESS IS THE MINIMUM THICKNESS OF THE BASE MATERIAL.

DIM	MILLIMETERS			INCHES		
	MIN.	NOM.	MAX.	MIN.	NOM.	MAX.
A	0.90	1.00	1.10	0.035	0.039	0.043
A1	0.01	0.06	0.10	0.001	0.002	0.004
b	0.25	0.37	0.50	0.010	0.015	0.020
c	0.10	0.18	0.26	0.004	0.007	0.010
D	2.90	3.00	3.10	0.114	0.118	0.122
E	1.30	1.50	1.70	0.051	0.059	0.067
e	0.85	0.95	1.05	0.034	0.037	0.041
HE	2.50	2.75	3.00	0.099	0.108	0.118
L	0.20	0.40	0.60	0.008	0.016	0.024
M	0*	---	10*	0*	---	10*

GENERIC MARKING DIAGRAM\*

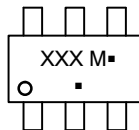

- XXX = Specific Device Code
- M = Date Code
- = Pb-Free Package

(Note: Microdot may be in either location)

\*This information is generic. Please refer to device data sheet for actual part marking. Pb-Free indicator, "G" or microdot "▪", may or may not be present. Some products may not follow the Generic Marking.

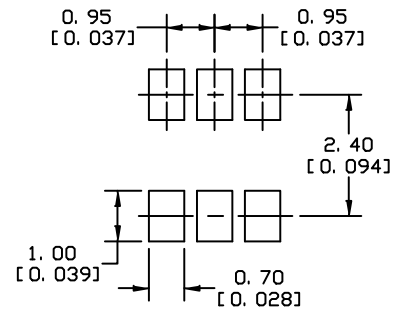

\* For additional information on our Pb-Free strategy and soldering details, please download the DN Semiconductor Soldering and Mounting Techniques Reference Manual, SOLDERM/D.

SOLDERING FOOTPRINT

- |   |  |   |  |   |   |
|---|--|---|--|---|---|
| <p>STYLE 1:<br/>PIN 1. CATHODE<br/>2. ANODE<br/>3. CATHODE<br/>4. CATHODE<br/>5. ANODE<br/>6. CATHODE</p>     | <p>STYLE 2:<br/>PIN 1. NO CONNECTION<br/>2. COLLECTOR<br/>3. EMITTER<br/>4. NO CONNECTION<br/>5. COLLECTOR<br/>6. BASE</p> | <p>STYLE 3:<br/>PIN 1. EMITTER 1<br/>2. BASE 1<br/>3. COLLECTOR 2<br/>4. EMITTER 2<br/>5. BASE 2<br/>6. COLLECTOR 1</p> | <p>STYLE 4:<br/>PIN 1. COLLECTOR 2<br/>2. EMITTER 1/EMITTER 2<br/>3. COLLECTOR 1<br/>4. EMITTER 3<br/>5. BASE 1/BASE 2/COLLECTOR 3<br/>6. BASE 3</p> | <p>STYLE 5:<br/>PIN 1. CHANNEL 1<br/>2. ANODE<br/>3. CHANNEL 2<br/>4. CHANNEL 3<br/>5. CATHODE<br/>6. CHANNEL 4</p> | <p>STYLE 6:<br/>PIN 1. CATHODE<br/>2. ANODE<br/>3. CATHODE<br/>4. CATHODE<br/>5. CATHODE<br/>6. CATHODE</p> |
| <p>STYLE 7:<br/>PIN 1. SOURCE 1<br/>2. GATE 1<br/>3. DRAIN 2<br/>4. SOURCE 2<br/>5. GATE 2<br/>6. DRAIN 1</p> | <p>STYLE 8:<br/>PIN 1. EMITTER 1<br/>2. BASE 2<br/>3. COLLECTOR 2<br/>4. EMITTER 2<br/>5. BASE 1<br/>6. COLLECTOR 1</p>    | <p>STYLE 9:<br/>PIN 1. EMITTER 2<br/>2. BASE 2<br/>3. COLLECTOR 1<br/>4. EMITTER 1<br/>5. BASE 1<br/>6. COLLECTOR 2</p> | <p>STYLE 10:<br/>PIN 1. ANODE/CATHODE<br/>2. BASE<br/>3. EMITTER<br/>4. COLLECTOR<br/>5. ANODE<br/>6. CATHODE</p>                                    | <p>STYLE 11:<br/>PIN 1. EMITTER<br/>2. BASE<br/>3. ANODE/CATHODE<br/>4. ANODE<br/>5. CATHODE<br/>6. COLLECTOR</p>   |   |

DOCUMENT NUMBER:	98ASB42973B	Electronic versions are uncontrolled except when accessed directly from the Document Repository. Printed versions are uncontrolled except when stamped "CONTROLLED COPY" in red.
DESCRIPTION:	SC-74	PAGE 1 OF 1

onsemi and ONSEMI are trademarks of Semiconductor Components Industries, LLC dba onsemi or its subsidiaries in the United States and/or other countries. onsemi reserves the right to make changes without further notice to any products herein. onsemi makes no warranty, representation or guarantee regarding the suitability of its products for any particular purpose, nor does onsemi assume any liability arising out of the application or use of any product or circuit, and specifically disclaims any and all liability, including without limitation special, consequential or incidental damages. onsemi does not convey any license under its patent rights nor the rights of others.

**onsemi**, **Onsemi**, and other names, marks, and brands are registered and/or common law trademarks of Semiconductor Components Industries, LLC dba "**onsemi**" or its affiliates and/or subsidiaries in the United States and/or other countries. **onsemi** owns the rights to a number of patents, trademarks, copyrights, trade secrets, and other intellectual property. A listing of **onsemi**'s product/patent coverage may be accessed at [www.onsemi.com/site/pdf/Patent-Marking.pdf](http://www.onsemi.com/site/pdf/Patent-Marking.pdf). **onsemi** reserves the right to make changes at any time to any products or information herein, without notice. The information herein is provided "as-is" and **onsemi** makes no warranty, representation or guarantee regarding the accuracy of the information, product features, availability, functionality, or suitability of its products for any particular purpose, nor does **onsemi** assume any liability arising out of the application or use of any product or circuit, and specifically disclaims any and all liability, including without limitation special, consequential or incidental damages. Buyer is responsible for its products and applications using **onsemi** products, including compliance with all laws, regulations and safety requirements or standards, regardless of any support or applications information provided by **onsemi**. "Typical" parameters which may be provided in **onsemi** data sheets and/or specifications can and do vary in different applications and actual performance may vary over time. All operating parameters, including "Typicals" must be validated for each customer application by customer's technical experts. **onsemi** does not convey any license under any of its intellectual property rights nor the rights of others. **onsemi** products are not designed, intended, or authorized for use as a critical component in life support systems or any FDA Class 3 medical devices or medical devices with a same or similar classification in a foreign jurisdiction or any devices intended for implantation in the human body. Should Buyer purchase or use **onsemi** products for any such unintended or unauthorized application, Buyer shall indemnify and hold **onsemi** and its officers, employees, subsidiaries, affiliates, and distributors harmless against all claims, costs, damages, and expenses, and reasonable attorney fees arising out of, directly or indirectly, any claim of personal injury or death associated with such unintended or unauthorized use, even if such claim alleges that **onsemi** was negligent regarding the design or manufacture of the part. **onsemi** is an Equal Opportunity/Affirmative Action Employer. This literature is subject to all applicable copyright laws and is not for resale in any manner.

---

## ADDITIONAL INFORMATION

### TECHNICAL PUBLICATIONS:

Technical Library: [www.onsemi.com/design/resources/technical-documentation](http://www.onsemi.com/design/resources/technical-documentation)  
onsemi Website: [www.onsemi.com](http://www.onsemi.com)

### ONLINE SUPPORT: [www.onsemi.com/support](http://www.onsemi.com/support)

For additional information, please contact your local Sales Representative at [www.onsemi.com/support/sales](http://www.onsemi.com/support/sales)