

NUF4220MN

Audio EMI Filter, 4 Line, with ESD Protection

NUF4220MN is a 4 line LC EMI filter array designed for audio applications. It offers greater than -30 dB attenuation at frequencies from 800 MHz to 5.0 GHz, with no line loss. This part is a single chip solution for audio interface applications, 2 speaker lines with a microphone line. This device also offers ESD protection—clamping transients from static discharges and ESD protection is provided across all capacitors.

Features

- Provides EMI Filtering and ESD Protection
- Integration of 20 Discretes
- Compliance with IEC61000-4-2 (Level 4)
18 kV (Contact)
- DFN8, 2x2 mm Package
- Moisture Sensitivity Level 1
- ESD Ratings: Machine Model = C
Human Body Model = 3B
- Excellent Line Efficiency with Low Line Resistance < 1.1 Ω max
- This is a Pb-Free Device*

Applications

- Headset
- MP3s
- PDAs
- Digital Cameras
- Portable DVDs
- Handfree Interface



ON Semiconductor®

<http://onsemi.com>

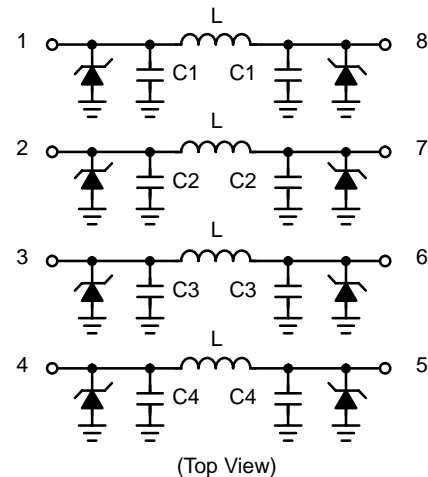

MARKING DIAGRAM

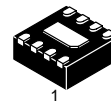

**DFN8
CASE 506AA
PLASTIC**

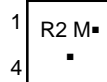

R2 = Specific Device Code
M = Date Code
▪ = Pb-Free Package

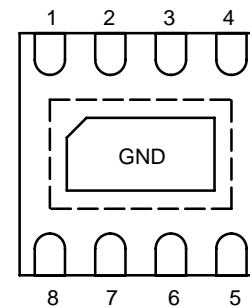

(Bottom View)

ORDERING INFORMATION

Device	Package	Shipping†
NUF4220MNT1G	DFN8 (Pb-Free)	3000 / Tape & Reel

*For additional information on our Pb-Free strategy and soldering details, please download the ON Semiconductor Soldering and Mounting Techniques Reference Manual, SOLDERRM/D.

†For information on tape and reel specifications, including part orientation and tape sizes, please refer to our Tape and Reel Packaging Specification Brochure, BRD8011/D.

NUF4220MN

MAXIMUM RATINGS

Parameter	Symbol	Value	Unit
ESD Discharge IEC61000-4-2 Contact Discharge	V_{PP}	18	kV
Steady-State Power per Inductor	P_L	90	mW
Steady-State Power per Package	P_T	360	mW
Operating Temperature Range	T_{OP}	-40 to 85	°C
Storage Temperature Range	T_{stg}	-55 to 150	°C
Maximum Lead Temperature for Soldering Purposes (1.8 in from case for 10 s)	T_L	260	°C

Stresses exceeding Maximum Ratings may damage the device. Maximum Ratings are stress ratings only. Functional operation above the Recommended Operating Conditions is not implied. Extended exposure to stresses above the Recommended Operating Conditions may affect device reliability.

ELECTRICAL CHARACTERISTICS ($T_J = 25^\circ\text{C}$ unless otherwise noted)

Parameter	Test Conditions	Symbol	Min	Typ	Max	Unit
Maximum Reverse Working Voltage		V_{RWM}			5.0	V
Breakdown Voltage	$I_R = 1.0 \text{ mA}$	V_{BR}	6.0	7.0	8.0	V
Leakage Current	$V_{RWM} = 3.3 \text{ V}$	I_R			0.1	μA
Inductance		L		4.9		nH
Series Resistance		R_S	0.6	0.85	1.1	Ω
Capacitance (Note 1, 3)		C_d		205		pF
Cut-Off Frequency (Note 2)	Above this frequency, appreciable attenuation occurs	f_{3dB}		16		MHz

1. Measured at 25°C , $V_R = 0 \text{ V}$, $f = 1.0 \text{ MHz}$.
2. 50Ω source and 50Ω load termination.
3. Total line capacitance is 2 times the diode capacitance (C_d).

NUF4220MN

TYPICAL PERFORMANCE CURVES

($T_A = 25^\circ\text{C}$ unless otherwise specified)

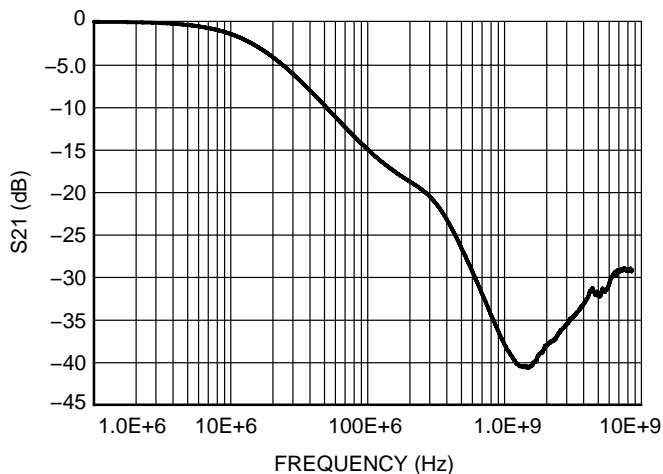

Figure 1. Typical Insertion Loss Characteristics

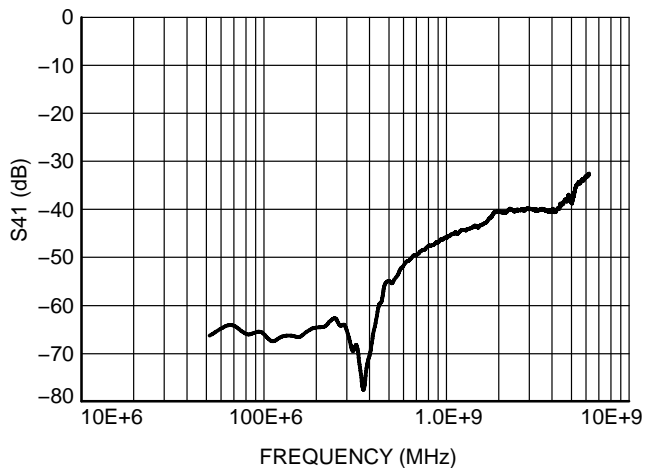

Figure 2. Typical Analog Crosstalk

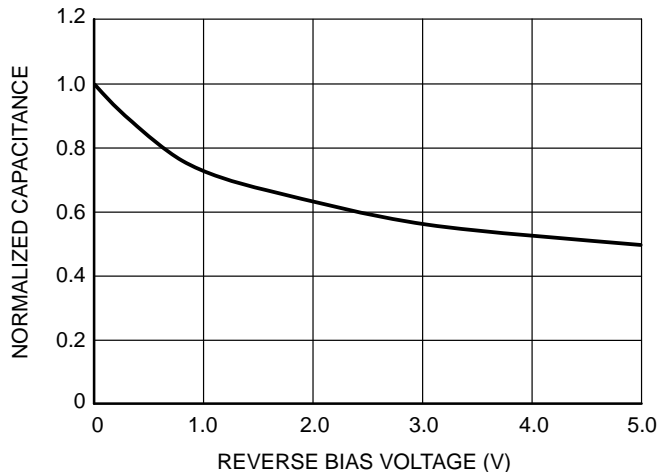

Figure 3. Typical Line Capacitance vs. Reverse Bias Voltage (Normalized to Capacitance @ 0 V)

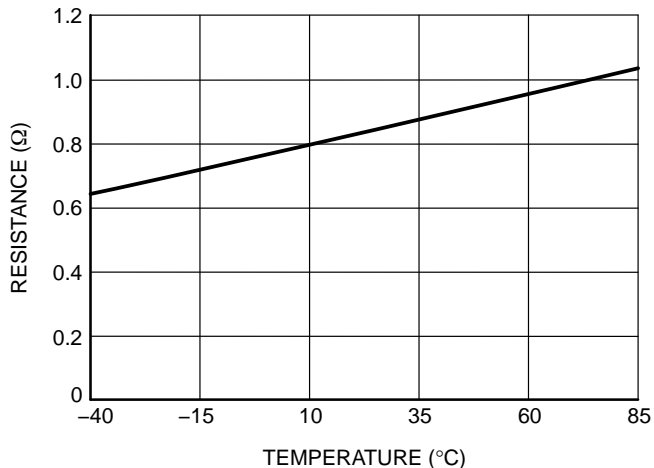
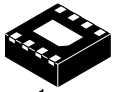

Figure 4. Typical Resistance Over Temperature



SCALE 4:1

DFN8 2x2, 0.5P
CASE 506AA
ISSUE F

DATE 04 MAY 2016

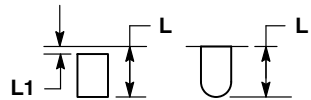
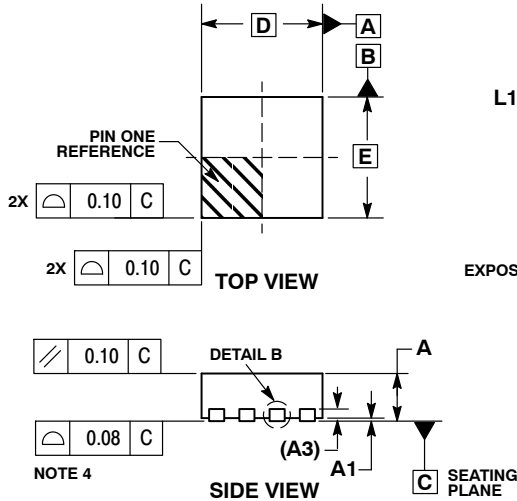

- NOTES:
1. DIMENSIONING AND TOLERANCING PER ASME Y14.5M, 1994 .
 2. CONTROLLING DIMENSION: MILLIMETERS.
 3. DIMENSION b APPLIES TO PLATED TERMINAL AND IS MEASURED BETWEEN 0.15 AND 0.20 MM FROM TERMINAL TIP.
 4. COPLANARITY APPLIES TO THE EXPOSED PAD AS WELL AS THE TERMINALS.

DIM	MILLIMETERS	
	MIN	MAX
A	0.80	1.00
A1	0.00	0.05
A3	0.20 REF	
b	0.20	0.30
D	2.00 BSC	
D2	1.10	1.30
E	2.00 BSC	
E2	0.70	0.90
e	0.50 BSC	
K	0.30 REF	
L	0.25	0.35
L1	---	0.10

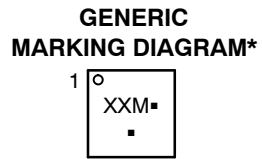
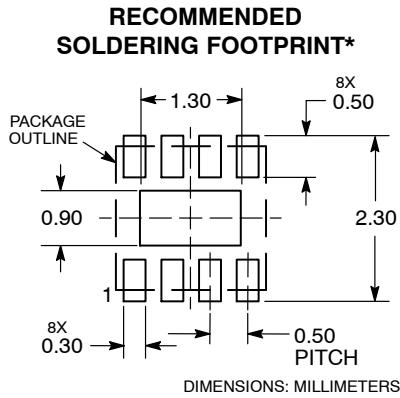
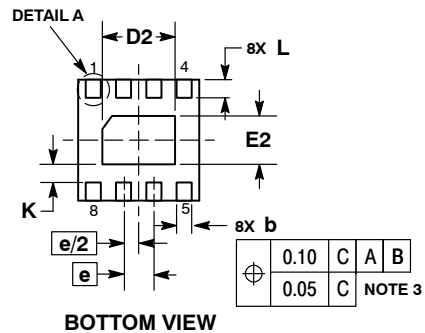

- XX = Specific Device Code
- M = Date Code
- = Pb-Free Device

*This information is generic. Please refer to device data sheet for actual part marking. Pb-Free indicator, "G" or microdot "▪", may or may not be present. Some products may not follow the Generic Marking.

*For additional information on our Pb-Free strategy and soldering details, please download the onsemi Soldering and Mounting Techniques Reference Manual, SOLDERRM/D.

DOCUMENT NUMBER:	98AON18658D	Electronic versions are uncontrolled except when accessed directly from the Document Repository. Printed versions are uncontrolled except when stamped "CONTROLLED COPY" in red.
DESCRIPTION:	DFN8, 2.0X2.0, 0.5MM PITCH	PAGE 1 OF 1

onsemi and onsemi are trademarks of Semiconductor Components Industries, LLC dba onsemi or its subsidiaries in the United States and/or other countries. onsemi reserves the right to make changes without further notice to any products herein. onsemi makes no warranty, representation or guarantee regarding the suitability of its products for any particular purpose, nor does onsemi assume any liability arising out of the application or use of any product or circuit, and specifically disclaims any and all liability, including without limitation special, consequential or incidental damages. onsemi does not convey any license under its patent rights nor the rights of others.

onsemi, **Onsemi**, and other names, marks, and brands are registered and/or common law trademarks of Semiconductor Components Industries, LLC dba "**onsemi**" or its affiliates and/or subsidiaries in the United States and/or other countries. **onsemi** owns the rights to a number of patents, trademarks, copyrights, trade secrets, and other intellectual property. A listing of **onsemi**'s product/patent coverage may be accessed at www.onsemi.com/site/pdf/Patent-Marking.pdf. **onsemi** reserves the right to make changes at any time to any products or information herein, without notice. The information herein is provided "as-is" and **onsemi** makes no warranty, representation or guarantee regarding the accuracy of the information, product features, availability, functionality, or suitability of its products for any particular purpose, nor does **onsemi** assume any liability arising out of the application or use of any product or circuit, and specifically disclaims any and all liability, including without limitation special, consequential or incidental damages. Buyer is responsible for its products and applications using **onsemi** products, including compliance with all laws, regulations and safety requirements or standards, regardless of any support or applications information provided by **onsemi**. "Typical" parameters which may be provided in **onsemi** data sheets and/or specifications can and do vary in different applications and actual performance may vary over time. All operating parameters, including "Typicals" must be validated for each customer application by customer's technical experts. **onsemi** does not convey any license under any of its intellectual property rights nor the rights of others. **onsemi** products are not designed, intended, or authorized for use as a critical component in life support systems or any FDA Class 3 medical devices or medical devices with a same or similar classification in a foreign jurisdiction or any devices intended for implantation in the human body. Should Buyer purchase or use **onsemi** products for any such unintended or unauthorized application, Buyer shall indemnify and hold **onsemi** and its officers, employees, subsidiaries, affiliates, and distributors harmless against all claims, costs, damages, and expenses, and reasonable attorney fees arising out of, directly or indirectly, any claim of personal injury or death associated with such unintended or unauthorized use, even if such claim alleges that **onsemi** was negligent regarding the design or manufacture of the part. **onsemi** is an Equal Opportunity/Affirmative Action Employer. This literature is subject to all applicable copyright laws and is not for resale in any manner.

ADDITIONAL INFORMATION

TECHNICAL PUBLICATIONS:

Technical Library: www.onsemi.com/design/resources/technical-documentation
onsemi Website: www.onsemi.com

ONLINE SUPPORT: www.onsemi.com/support

For additional information, please contact your local Sales Representative at www.onsemi.com/support/sales