

# NTUD3127C

## Small Signal MOSFET

20 V, 200 mA / -180 mA, Complementary,  
1.0 x 1.0 mm SOT-963 Package



ON Semiconductor®

<http://onsemi.com>

### Features

- Complementary MOSFET Device
- 1.5 V Gate Voltage Rating
- Ultra Thin Profile (< 0.5 mm) Allows It to Fit Easily into Extremely Thin Environments such as Portable Electronics.
- These are Pb-Free Devices

### Applications

- Load Switch with Level Shift
- Optimized for Power Management in Ultra Portable Equipment

### MAXIMUM RATINGS ( $T_J = 25^\circ\text{C}$ unless otherwise specified)

Parameter			Symbol	Value	Unit
Drain-to-Source Voltage			$V_{DSS}$	20	V
Gate-to-Source Voltage			$V_{GS}$	$\pm 8$	V
N-Channel Continuous Drain Current (Note 1)	Steady State	$T_A = 25^\circ\text{C}$	$I_D$	160	mA
		$T_A = 85^\circ\text{C}$		115	
	$t \leq 5$ s	$T_A = 25^\circ\text{C}$		200	
P-Channel Continuous Drain Current (Note 1)	Steady State	$T_A = 25^\circ\text{C}$		-140	
		$T_A = 85^\circ\text{C}$		-100	
	$t \leq 5$ s	$T_A = 25^\circ\text{C}$		-180	
Power Dissipation (Note 1)	Steady State	$T_A = 25^\circ\text{C}$	$P_D$	125	mW
				$t \leq 5$ s	
Pulsed Drain Current	N-Channel	$t_p = 10 \mu\text{s}$	$I_{DM}$	800	mA
	P-Channel			-600	
Operating Junction and Storage Temperature			$T_J$ , $T_{STG}$	-55 to 150	$^\circ\text{C}$
Source Current (Body Diode) (Note 2)			$I_S$	200	mA
Lead Temperature for Soldering Purposes (1/8" from case for 10 s)			$T_L$	260	$^\circ\text{C}$

Stresses exceeding Maximum Ratings may damage the device. Maximum Ratings are stress ratings only. Functional operation above the Recommended Operating Conditions is not implied. Extended exposure to stresses above the Recommended Operating Conditions may affect device reliability.

1. Surface-mounted on FR4 board using the minimum recommended pad size, 1 oz. Cu.
2. Pulse Test: pulse width  $\leq 300 \mu\text{s}$ , duty cycle  $\leq 2\%$

$V_{(BR)DSS}$	$R_{DS(on)}$ Max	$I_D$ Max
P-Channel -20 V	5.0 $\Omega$ @ -4.5 V	-0.18 A
	7.0 $\Omega$ @ -2.5 V	
	10 $\Omega$ @ -1.8 V	
	14 $\Omega$ @ -1.5 V	
N-Channel 20 V	3.0 $\Omega$ @ 4.5 V	0.20 A
	4.0 $\Omega$ @ 2.5 V	
	6.0 $\Omega$ @ 1.8 V	
	10 $\Omega$ @ 1.5 V	

### PINOUT: SOT-963

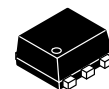
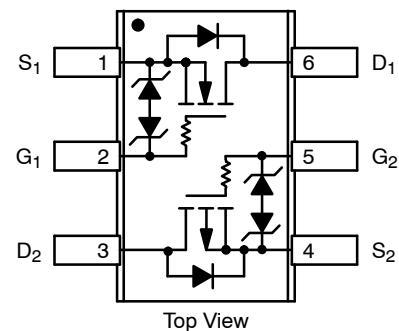

SOT-963  
CASE 527AA

### MARKING DIAGRAM

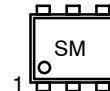

S = Specific Device Code  
M = Date Code

### ORDERING INFORMATION

Device	Package	Shipping†
NTUD3127CT5G	SOT-963 (Pb-Free)	8000 / Tape & Reel

†For information on tape and reel specifications, including part orientation and tape sizes, please refer to our Tape and Reel Packaging Specifications Brochure, BRD8011/D.

# NTUD3127C

## THERMAL RESISTANCE RATINGS

Parameter	Symbol	Max	Unit
Junction-to-Ambient – Steady State, Minimum Pad (Note 3)	$R_{\theta JA}$	1000	°C/W
Junction-to-Ambient – $t \leq 5$ s (Note 3)		600	

3. Surface-mounted on FR4 board using the minimum recommended pad size, 1 oz. Cu.

## ELECTRICAL CHARACTERISTICS ( $T_J = 25^\circ\text{C}$ unless otherwise specified)

Parameter	Symbol	N/P	Test Condition	Min	Typ	Max	Unit
<b>OFF CHARACTERISTICS</b>							
Drain-to-Source Breakdown Voltage	$V_{(BR)DSS}$	N	$V_{GS} = 0\text{ V}$	$I_D = 250\ \mu\text{A}$	20		V
		P		$I_D = -250\ \mu\text{A}$	-20		
Zero Gate Voltage Drain Current	$I_{DSS}$	N	$V_{GS} = 0\text{ V}, V_{DS} = 5.0\text{ V}$	$T_J = 25^\circ\text{C}$		50	nA
				$T_J = 85^\circ\text{C}$		200	
		P		$T_J = 25^\circ\text{C}$		-50	
				$T_J = 85^\circ\text{C}$		-200	
Zero Gate Voltage Drain Current	$I_{DSS}$	N	$V_{GS} = 0\text{ V}, V_{DS} = 16\text{ V}$	$T_J = 25^\circ\text{C}$		100	nA
		P	$V_{GS} = 0\text{ V}, V_{DS} = -16\text{ V}$			-100	
Gate-to-Source Leakage Current	$I_{GSS}$	N	$V_{DS} = 0\text{ V}, V_{GS} = \pm 5.0\text{ V}$			100	nA
		P				-100	

## ON CHARACTERISTICS (Note 4)

Gate Threshold Voltage	$V_{GS(TH)}$	N	$V_{GS} = V_{DS}$	$I_D = 250\ \mu\text{A}$	0.4	1.0	V
		P		$I_D = -250\ \mu\text{A}$	-0.4	-1.0	
Drain-to-Source On Resistance	$R_{DS(on)}$	N	$V_{GS} = 4.5\text{ V}, I_D = 100\text{ mA}$		1.5	3.0	$\Omega$
		P	$V_{GS} = -4.5\text{ V}, I_D = -100\text{ mA}$		4.0	5.0	
		N	$V_{GS} = 2.5\text{ V}, I_D = 50\text{ mA}$		2.0	4.0	
		P	$V_{GS} = -2.5\text{ V}, I_D = -50\text{ mA}$		5.0	7.0	
		N	$V_{GS} = 1.8\text{ V}, I_D = 20\text{ mA}$		3.0	6.0	
		P	$V_{GS} = -1.8\text{ V}, I_D = -20\text{ mA}$		6.5	10	
		N	$V_{GS} = 1.5\text{ V}, I_D = 10\text{ mA}$		4.0	10	
		P	$V_{GS} = -1.5\text{ V}, I_D = -10\text{ mA}$		7.5	14	
		N	$V_{GS} = 1.2\text{ V}, I_D = 1.0\text{ mA}$		5.5		
		P	$V_{GS} = -1.2\text{ V}, I_D = -1.0\text{ mA}$		11.5		
Forward Transconductance	$g_{FS}$	N	$V_{DS} = 5.0\text{ V}, I_D = 125\text{ mA}$		0.35		S
		P	$V_{DS} = -5.0\text{ V}, I_D = -125\text{ mA}$		0.26		

## CHARGES, CAPACITANCES AND GATE RESISTANCE

Input Capacitance	$C_{ISS}$	N	$f = 1\text{ MHz}, V_{GS} = 0\text{ V}$ $V_{DS} = 15\text{ V}$		9.0		pF
Output Capacitance	$C_{OSS}$				3.0		
Reverse Transfer Capacitance	$C_{RSS}$				2.2		
Input Capacitance	$C_{ISS}$	P	$f = 1\text{ MHz}, V_{GS} = 0\text{ V}$ $V_{DS} = -15\text{ V}$		12		
Output Capacitance	$C_{OSS}$				2.7		
Reverse Transfer Capacitance	$C_{RSS}$				1.0		

4. Switching characteristics are independent of operating junction temperatures

# NTUD3127C

## ELECTRICAL CHARACTERISTICS ( $T_J = 25^\circ\text{C}$ unless otherwise specified)

Parameter	Symbol	N/P	Test Condition	Min	Typ	Max	Unit
-----------	--------	-----	----------------	-----	-----	-----	------

### SWITCHING CHARACTERISTICS, $V_{GS} = 4.5\text{ V}$ (Note 4)

Turn-On Delay Time	$t_{d(ON)}$	N	$V_{GS} = 4.5\text{ V}, V_{DD} = 10\text{ V}, I_D = 200\text{ mA}, R_G = 2.0\ \Omega$		15		ns
Rise Time	$t_r$				24		
Turn-Off Delay Time	$t_{d(OFF)}$				90		
Fall Time	$t_f$				60		
Turn-On Delay Time	$t_{d(ON)}$	P	$V_{GS} = -4.5\text{ V}, V_{DD} = -15\text{ V}, I_D = -180\text{ mA}, R_G = 2.0\ \Omega$		20		
Rise Time	$t_r$				37		
Turn-Off Delay Time	$t_{d(OFF)}$				112		
Fall Time	$t_f$				97		

### DRAIN-SOURCE DIODE CHARACTERISTICS

Forward Diode Voltage	$V_{SD}$	N	$V_{GS} = 0\text{ V}, I_S = 10\text{ mA}$	$T_J = 25^\circ\text{C}$		0.60	1.0	V
		P	$V_{GS} = 0\text{ V}, I_S = -10\text{ mA}$			-0.65	-1.0	

4. Switching characteristics are independent of operating junction temperatures

TYPICAL PERFORMANCE CURVES – N-CANNEL

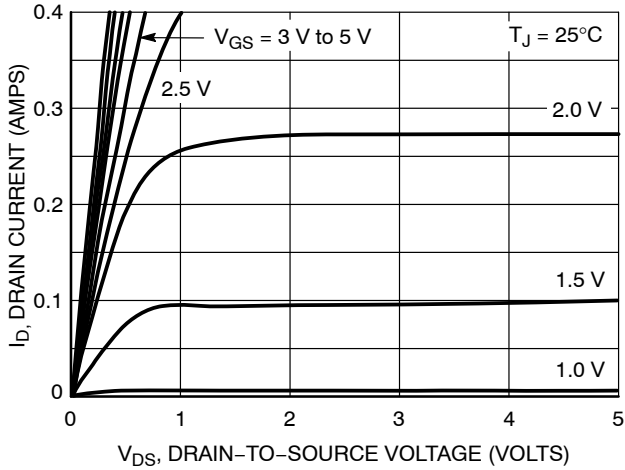

Figure 1. On-Region Characteristics

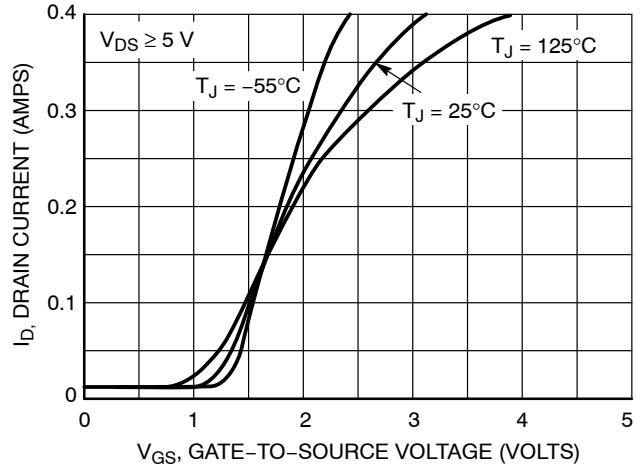

Figure 2. Transfer Characteristics

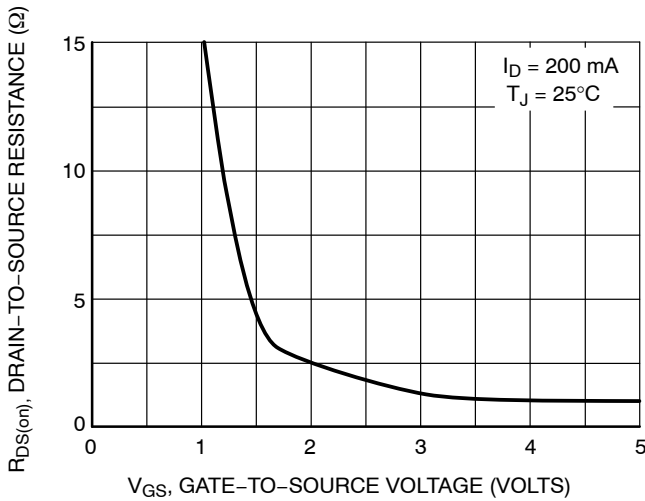

Figure 3. On-Resistance vs. Gate Voltage

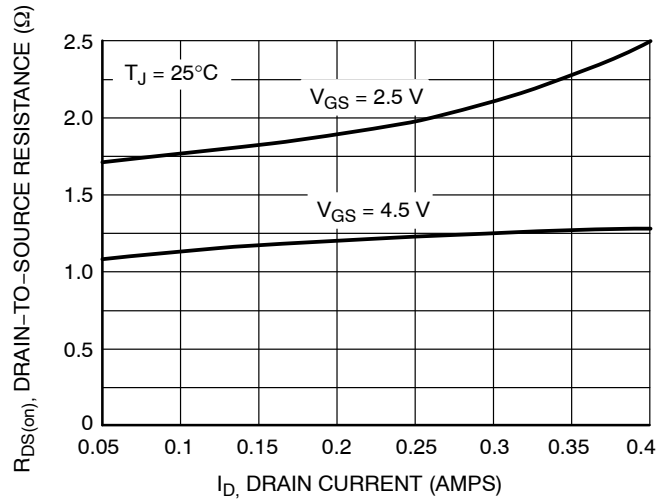

Figure 4. On-Resistance vs. Drain Current and Gate Voltage

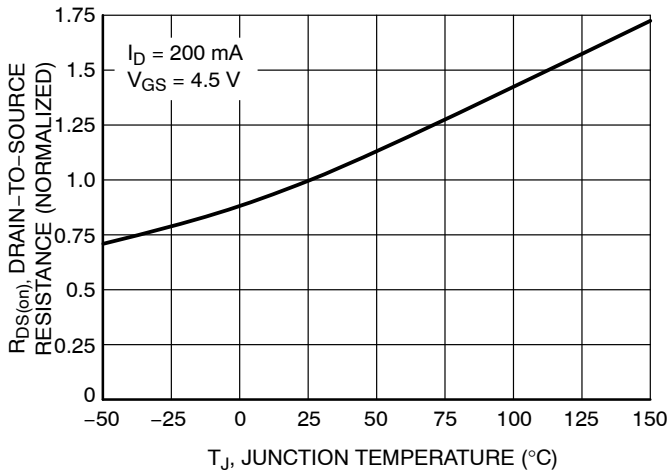

Figure 5. On-Resistance Variation with Temperature

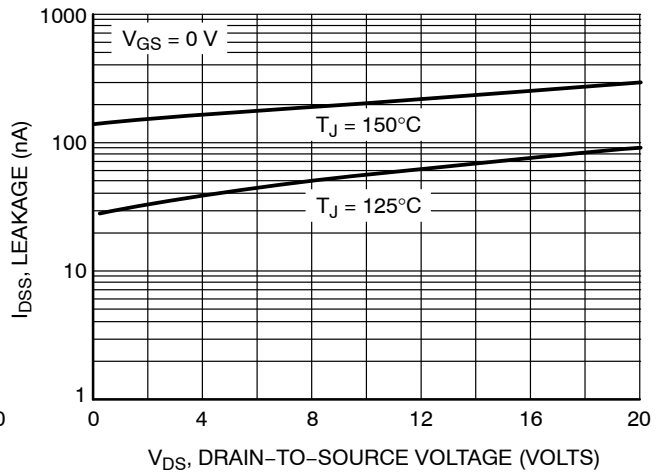

Figure 6. Drain-to-Source Leakage Current vs. Voltage

TYPICAL PERFORMANCE CURVES - N-CHANNEL

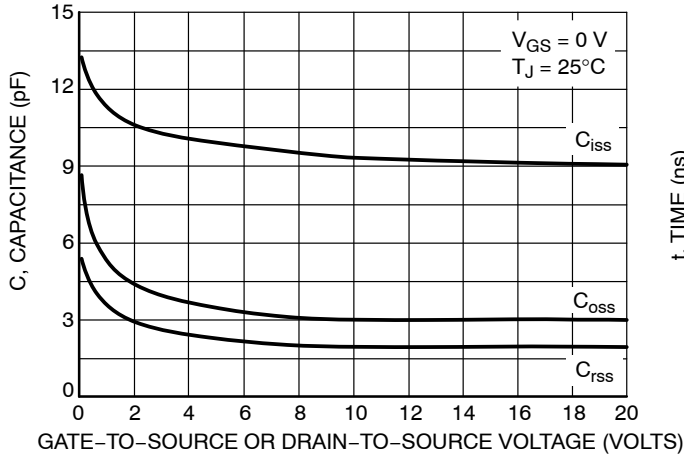

Figure 7. Capacitance Variation

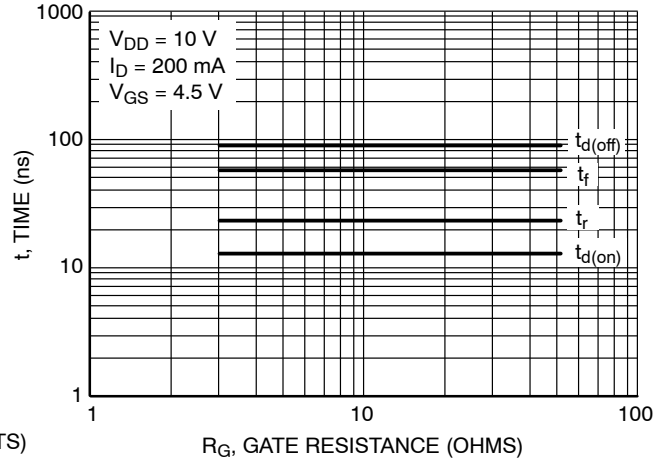

Figure 8. Resistive Switching Time Variation vs. Gate Resistance

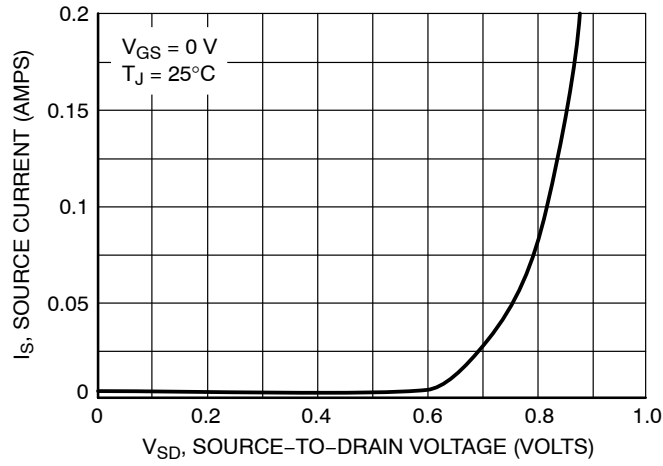

Figure 9. Diode Forward Voltage vs. Current

TYPICAL PERFORMANCE CURVES – P-CHANNEL

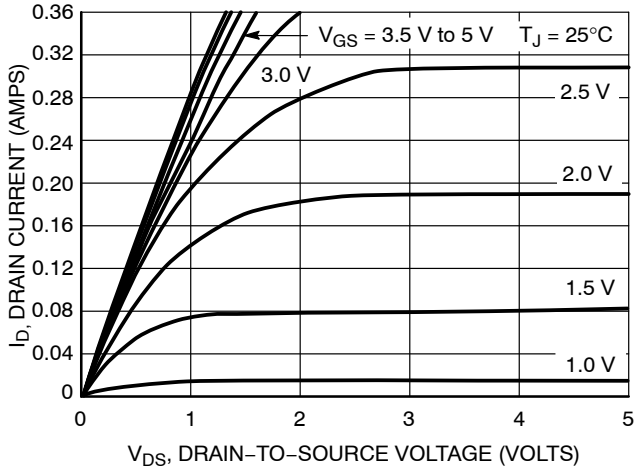

Figure 10. On-Region Characteristics

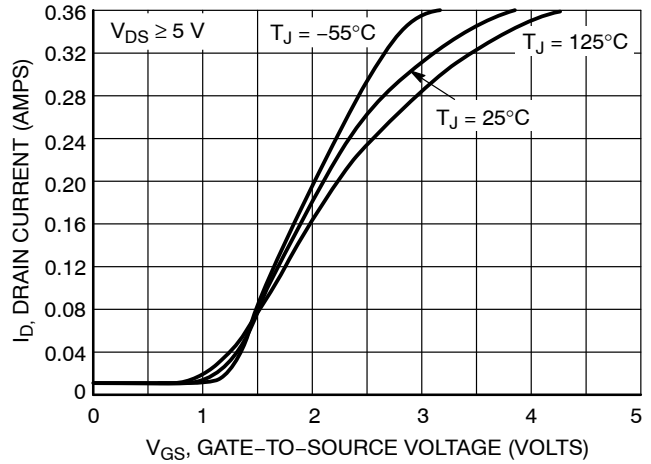

Figure 11. Transfer Characteristics

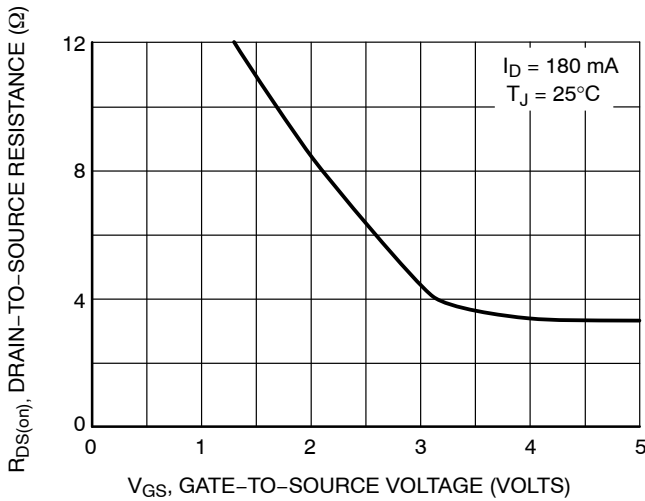

Figure 12. On-Resistance vs. Gate Voltage

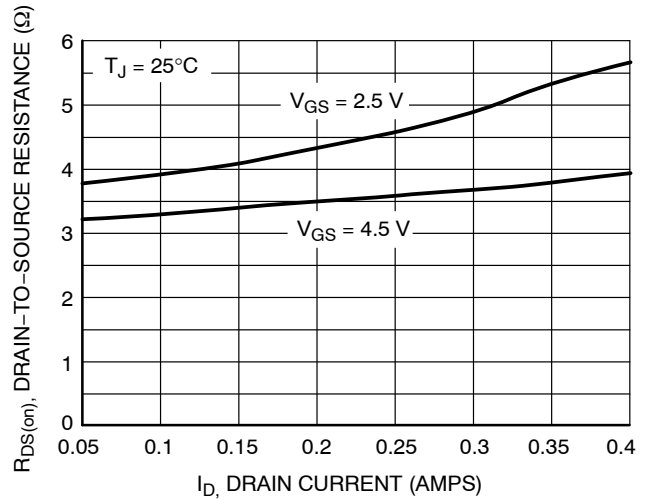

Figure 13. On-Resistance vs. Drain Current and Gate Voltage

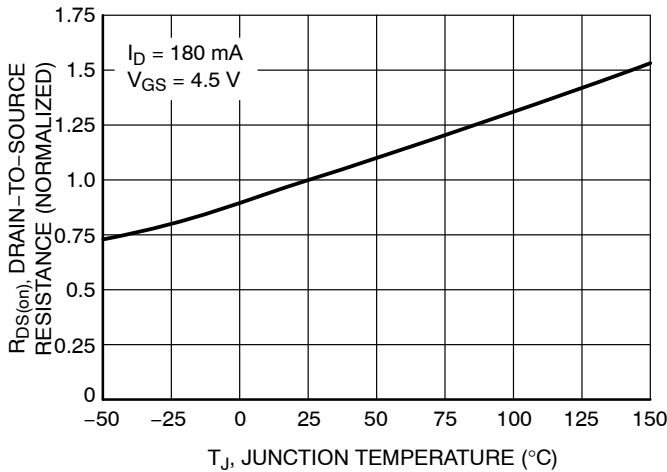

Figure 14. On-Resistance Variation with Temperature

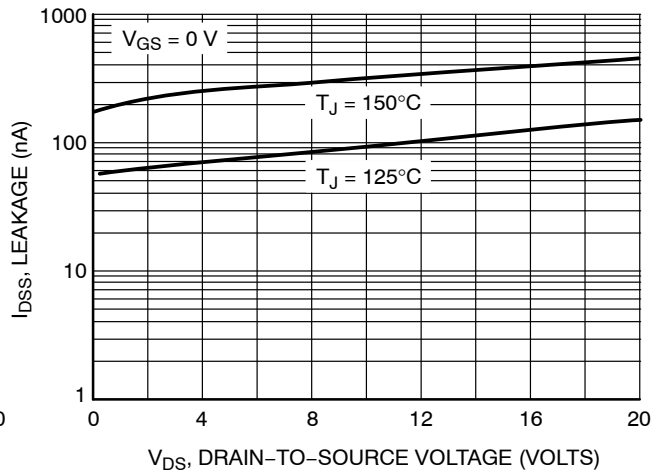

Figure 15. Drain-to-Source Leakage Current vs. Voltage

TYPICAL PERFORMANCE CURVES - P-CHANNEL

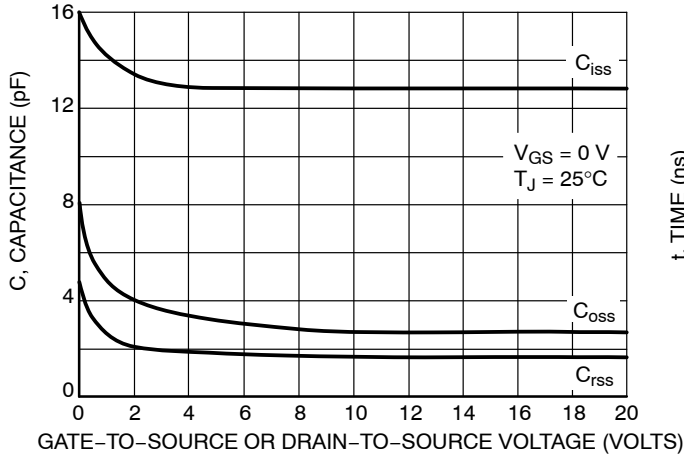

Figure 16. Capacitance Variation

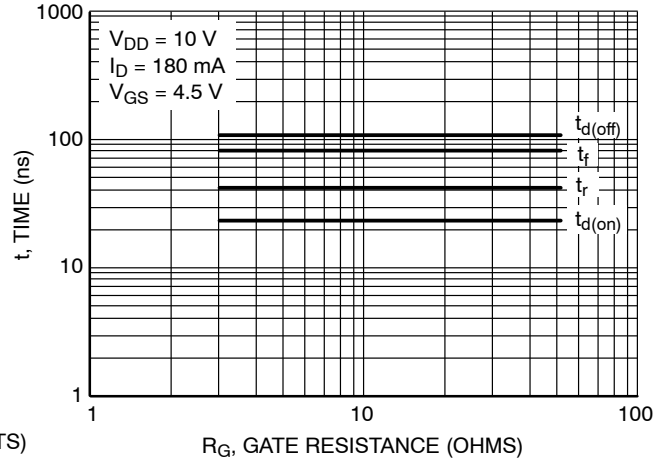

Figure 17. Resistive Switching Time Variation vs. Gate Resistance

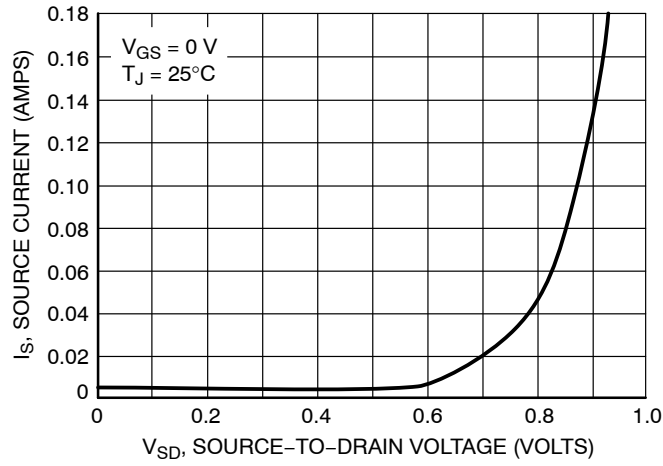

Figure 18. Diode Forward Voltage vs. Current

# MECHANICAL CASE OUTLINE

## PACKAGE DIMENSIONS

ON Semiconductor®



**SOT-963**  
CASE 527AA-01  
ISSUE D

DATE 30 JUL 2008

  
SCALE 4:1

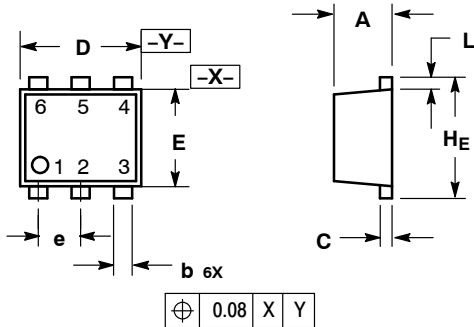

**NOTES:**

1. DIMENSIONING AND TOLERANCING PER ANSI Y14.5M, 1982.
2. CONTROLLING DIMENSION: MILLIMETERS
3. MAXIMUM LEAD THICKNESS INCLUDES LEAD FINISH THICKNESS. MINIMUM LEAD THICKNESS IS THE MINIMUM THICKNESS OF BASE MATERIAL

DIM	MILLIMETERS			INCHES		
	MIN	NOM	MAX	MIN	NOM	MAX
A	0.40	0.45	0.50	0.016	0.018	0.020
b	0.10	0.15	0.20	0.004	0.006	0.008
C	0.05	0.10	0.15	0.002	0.004	0.006
D	0.95	1.00	1.05	0.037	0.039	0.041
E	0.75	0.80	0.85	0.03	0.032	0.034
e	0.35 BSC			0.014 BSC		
L	0.05	0.10	0.15	0.002	0.004	0.006
H <sub>E</sub>	0.95	1.00	1.05	0.037	0.039	0.041

- |  |   |  |
|--|---|--|
| <p><b>STYLE 1:</b><br/>PIN 1. EMITTER 1<br/>2. BASE 1<br/>3. COLLECTOR 2<br/>4. EMITTER 2<br/>5. BASE 2<br/>6. COLLECTOR 1</p> | <p><b>STYLE 2:</b><br/>PIN 1. EMITTER 1<br/>2. EMITTER2<br/>3. BASE 2<br/>4. COLLECTOR 2<br/>5. BASE 1<br/>6. COLLECTOR 1</p> | <p><b>STYLE 3:</b><br/>PIN 1. CATHODE 1<br/>2. CATHODE 1<br/>3. ANODE/ANODE 2<br/>4. CATHODE 2<br/>5. CATHODE 2<br/>6. ANODE/ANODE 1</p> |
| <p><b>STYLE 4:</b><br/>PIN 1. COLLECTOR<br/>2. COLLECTOR<br/>3. BASE<br/>4. EMITTER<br/>5. COLLECTOR<br/>6. COLLECTOR</p>      | <p><b>STYLE 5:</b><br/>PIN 1. CATHODE<br/>2. CATHODE<br/>3. ANODE<br/>4. ANODE<br/>5. CATHODE<br/>6. CATHODE</p>              | <p><b>STYLE 6:</b><br/>PIN 1. CATHODE<br/>2. ANODE<br/>3. CATHODE<br/>4. CATHODE<br/>5. CATHODE<br/>6. CATHODE</p>                       |
| <p><b>STYLE 7:</b><br/>PIN 1. CATHODE<br/>2. ANODE<br/>3. CATHODE<br/>4. CATHODE<br/>5. ANODE<br/>6. CATHODE</p>               | <p><b>STYLE 8:</b><br/>PIN 1. DRAIN<br/>2. DRAIN<br/>3. GATE<br/>4. SOURCE<br/>5. DRAIN<br/>6. DRAIN</p>                      | <p><b>STYLE 9:</b><br/>PIN 1. SOURCE 1<br/>2. GATE 1<br/>3. DRAIN 2<br/>4. SOURCE 2<br/>5. GATE 2<br/>6. DRAIN 1</p>                     |
| <p><b>STYLE 10:</b><br/>PIN 1. CATHODE 1<br/>2. N/C<br/>3. CATHODE 2<br/>4. ANODE 2<br/>5. N/C<br/>6. ANODE 1</p>              |   |  |

**GENERIC MARKING DIAGRAM\***

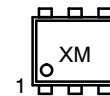

X = Specific Device Code  
M = Month Code

\*This information is generic. Please refer to device data sheet for actual part marking.  
Pb-Free indicator, "G" or microdot "▪", may or may not be present.

**SOLDERING FOOTPRINT\***

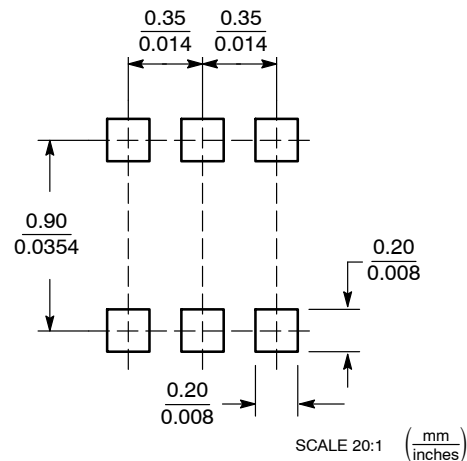

\*For additional information on our Pb-Free strategy and soldering details, please download the ON Semiconductor Soldering and Mounting Techniques Reference Manual, SOLDERRM/D.

<b>DOCUMENT NUMBER:</b>	<b>98AON18698D</b>	Electronic versions are uncontrolled except when accessed directly from the Document Repository. Printed versions are uncontrolled except when stamped "CONTROLLED COPY" in red.
<b>DESCRIPTION:</b>	<b>SOT-963, 1X1, 0.35P</b>	<b>PAGE 1 OF 1</b>

ON Semiconductor and  are trademarks of Semiconductor Components Industries, LLC dba ON Semiconductor or its subsidiaries in the United States and/or other countries. ON Semiconductor reserves the right to make changes without further notice to any products herein. ON Semiconductor makes no warranty, representation or guarantee regarding the suitability of its products for any particular purpose, nor does ON Semiconductor assume any liability arising out of the application or use of any product or circuit, and specifically disclaims any and all liability, including without limitation special, consequential or incidental damages. ON Semiconductor does not convey any license under its patent rights nor the rights of others.



**onsemi**, **Onsemi**, and other names, marks, and brands are registered and/or common law trademarks of Semiconductor Components Industries, LLC dba "**onsemi**" or its affiliates and/or subsidiaries in the United States and/or other countries. **onsemi** owns the rights to a number of patents, trademarks, copyrights, trade secrets, and other intellectual property. A listing of **onsemi**'s product/patent coverage may be accessed at [www.onsemi.com/site/pdf/Patent-Marking.pdf](http://www.onsemi.com/site/pdf/Patent-Marking.pdf). **onsemi** reserves the right to make changes at any time to any products or information herein, without notice. The information herein is provided "as-is" and **onsemi** makes no warranty, representation or guarantee regarding the accuracy of the information, product features, availability, functionality, or suitability of its products for any particular purpose, nor does **onsemi** assume any liability arising out of the application or use of any product or circuit, and specifically disclaims any and all liability, including without limitation special, consequential or incidental damages. Buyer is responsible for its products and applications using **onsemi** products, including compliance with all laws, regulations and safety requirements or standards, regardless of any support or applications information provided by **onsemi**. "Typical" parameters which may be provided in **onsemi** data sheets and/or specifications can and do vary in different applications and actual performance may vary over time. All operating parameters, including "Typicals" must be validated for each customer application by customer's technical experts. **onsemi** does not convey any license under any of its intellectual property rights nor the rights of others. **onsemi** products are not designed, intended, or authorized for use as a critical component in life support systems or any FDA Class 3 medical devices or medical devices with a same or similar classification in a foreign jurisdiction or any devices intended for implantation in the human body. Should Buyer purchase or use **onsemi** products for any such unintended or unauthorized application, Buyer shall indemnify and hold **onsemi** and its officers, employees, subsidiaries, affiliates, and distributors harmless against all claims, costs, damages, and expenses, and reasonable attorney fees arising out of, directly or indirectly, any claim of personal injury or death associated with such unintended or unauthorized use, even if such claim alleges that **onsemi** was negligent regarding the design or manufacture of the part. **onsemi** is an Equal Opportunity/Affirmative Action Employer. This literature is subject to all applicable copyright laws and is not for resale in any manner.

---

## ADDITIONAL INFORMATION

### TECHNICAL PUBLICATIONS:

Technical Library: [www.onsemi.com/design/resources/technical-documentation](http://www.onsemi.com/design/resources/technical-documentation)  
onsemi Website: [www.onsemi.com](http://www.onsemi.com)

### ONLINE SUPPORT: [www.onsemi.com/support](http://www.onsemi.com/support)

For additional information, please contact your local Sales Representative at [www.onsemi.com/support/sales](http://www.onsemi.com/support/sales)