

NTLJS1102P

Power MOSFET

-8 V, -8.1 A, μ COOL™ Single P-Channel, 2x2 mm, WDFN package

Features

- WDFN Package with Exposed Drain Pad for Excellent Thermal Conduction
- Lowest $R_{DS(on)}$ in 2 x 2 mm Package
- 1.2 V $R_{DS(on)}$ Rating for Operation at Low Voltage Logic Level Gate Drive
- 2 x 2 mm Footprint Same as SC-88 Package
- Low Profile (<0.8 mm) for Easy Fit in Thin Environments
- This is a Halide-Free Device
- This is a Pb-Free Device

Applications

- High Side Load Switch
- Li Ion Battery Linear Mode Charging
- Optimized for Battery and Load Management Applications in Portable Equipment

MAXIMUM RATINGS ($T_J = 25^\circ\text{C}$ unless otherwise stated)

Parameter		Symbol	Value	Unit	
Drain-to-Source Voltage		V_{DSS}	-8	V	
Gate-to-Source Voltage		V_{GS}	± 6	V	
Continuous Drain Current (Note 1)	Steady State	I_D	$T_A = 25^\circ\text{C}$	-6.2	A
			$T_A = 85^\circ\text{C}$	-4.5	
	$t \leq 5 \text{ s}$	$T_A = 25^\circ\text{C}$	-8.1		
Power Dissipation (Note 1)	Steady State	P_D	$T_A = 25^\circ\text{C}$	1.9	W
	$t \leq 5 \text{ s}$		3.3		
Continuous Drain Current (Note 2)	Steady State	I_D	$T_A = 25^\circ\text{C}$	-3.7	A
			$T_A = 85^\circ\text{C}$	-2.7	
Power Dissipation (Note 2)	Steady State	P_D	$T_A = 25^\circ\text{C}$	0.7	W
Pulsed Drain Current		I_{DM}	-30	A	
Operating Junction and Storage Temperature		T_J, T_{STG}	-55 to 150	$^\circ\text{C}$	
Source Current (Body Diode) (Note 2)		I_S	-5.5	A	
Lead Temperature for Soldering Purposes (1/8" from case for 10 s)		T_L	260	$^\circ\text{C}$	

1. Surface-mounted on FR4 board using 1 in sq pad size (Cu area = 1.127 in sq [2 oz] including traces).
2. Surface-mounted on FR4 board using the minimum recommended pad size (Cu area = 30 mm² [2 oz] including traces).



ON Semiconductor®

<http://onsemi.com>

$V_{(BR)DSS}$	$R_{DS(on)}$ MAX	I_D MAX
-8.0 V	36 m Ω @ -4.5 V	-6.2 A
	45 m Ω @ -2.5 V	-5.5 A
	68 m Ω @ -1.8 V	-3.0 A
	90 m Ω @ -1.5 V	-1.0 A
	300 m Ω @ -1.2 V	-0.2 A

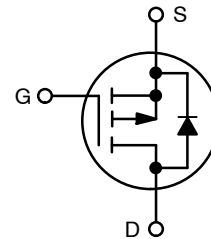

P-CHANNEL MOSFET

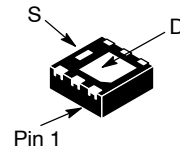

MARKING DIAGRAM

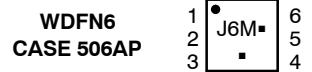

- J6 = Specific Device Code
 - M = Date Code
 - = Pb-Free Package
- (Note: Microdot may be in either location)

PIN CONNECTIONS

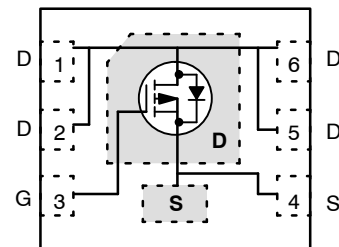

(Top View)

ORDERING INFORMATION

See detailed ordering and shipping information in the package dimensions section on page 3 of this data sheet.

NTLJS1102P

THERMAL RESISTANCE RATINGS

Parameter	Symbol	Max	Unit
Junction-to-Ambient – Steady State (Note 3)	$R_{\theta JA}$	65	°C/W
Junction-to-Ambient – $t \leq 5$ s (Note 3)	$R_{\theta JA}$	38	
Junction-to-Ambient – Steady State min Pad (Note 4)	$R_{\theta JA}$	180	

3. Surface-mounted on FR4 board using 1 in sq pad size (Cu area = 1.127 in sq [2 oz] including traces).
 4. Surface-mounted on FR4 board using the minimum recommended pad size (Cu area = 30 mm² [2 oz] including traces).

MOSFET ELECTRICAL CHARACTERISTICS ($T_J = 25^\circ\text{C}$ unless otherwise specified)

Parameter	Symbol	Test Condition	Min	Typ	Max	Unit
-----------	--------	----------------	-----	-----	-----	------

OFF CHARACTERISTICS

Drain-to-Source Breakdown Voltage	$V_{(BR)DSS}$	$V_{GS} = 0$ V, $I_D = -250$ μ A	-8.0			V
Drain-to-Source Breakdown Voltage Temperature Coefficient	$V_{(BR)DSS}/T_J$	$I_D = -250$ μ A, Ref to 25°C		-7.2		mV/°C
Zero Gate Voltage Drain Current	I_{DSS}	$V_{GS} = 0$ V, $V_{DS} = -8$ V	$T_J = 25^\circ\text{C}$ $T_J = 85^\circ\text{C}$		-1.0 -10	μ A
Gate-to-Source Leakage Current	I_{GSS}	$V_{DS} = 0$ V, $V_{GS} = \pm 6$ V			± 0.1	μ A

ON CHARACTERISTICS (Note 5)

Gate Threshold Voltage	$V_{GS(TH)}$	$V_{GS} = V_{DS}$, $I_D = -250$ μ A	-0.29		-0.72	V
Negative Threshold Temperature Coefficient	$V_{GS(TH)}/T_J$			2.7		mV/°C
Drain-to-Source On Resistance	$R_{DS(on)}$	$V_{GS} = -4.5$ V, $I_D = -6.2$ A		25	36	m Ω
		$V_{GS} = -4.5$ V, $I_D = -3.0$ A		25	36	
		$V_{GS} = -2.5$ V, $I_D = -5.5$ A		34	45	
		$V_{GS} = -2.5$ V, $I_D = -3.0$ A		34	45	
		$V_{GS} = -1.8$ V, $I_D = -3.0$ A		45	68	
		$V_{GS} = -1.5$ V, $I_D = -1.0$ A		55	90	
		$V_{GS} = -1.2$ V, $I_D = -0.2$ A		80	300	
Forward Transconductance	g_{FS}	$V_{DS} = -4$ V, $I_D = -6.2$ A		14.3		S

CHARGES, CAPACITANCES AND GATE RESISTANCE

Input Capacitance	C_{ISS}	$V_{GS} = 0$ V, $f = 1$ MHz, $V_{DS} = -4$ V		1585		pF
Output Capacitance	C_{OSS}			350		
Reverse Transfer Capacitance	C_{RSS}			185		
Total Gate Charge	$Q_{G(TOT)}$	$V_{GS} = -4.5$ V, $V_{DS} = -4$ V; $I_D = -6.2$ A		15.7	25	nC
Threshold Gate Charge	$Q_{G(TH)}$			0.8		
Gate-to-Source Charge	Q_{GS}			1.9		
Gate-to-Drain Charge	Q_{GD}			3.3		

SWITCHING CHARACTERISTICS, $V_{GS} = 4.5$ V (Note 6)

Turn-On Delay Time	$t_{D(ON)}$	$V_{GS} = -4.5$ V, $V_{DS} = -4$ V, $I_D = -6.2$ A, $R_G = 1$ Ω		8.0		ns
Rise Time	t_r			41		
Turn-Off Delay Time	$t_{d(OFF)}$			80		
Fall Time	t_f			70		

5. Pulse Test: pulse width ≤ 300 μ s, duty cycle $\leq 2\%$
 6. Switching characteristics are independent of operating junction temperatures

NTLJS1102P

MOSFET ELECTRICAL CHARACTERISTICS ($T_J = 25^\circ\text{C}$ unless otherwise specified)

Parameter	Symbol	Test Condition	Min	Typ	Max	Unit
SWITCHING CHARACTERISTICS, $V_{GS} = 4.5\text{ V}$ (Note 6)						
Turn-On Delay Time	$t_{D(ON)}$	$V_{GS} = -4.5\text{ V}, V_{DS} = -4\text{ V},$ $I_D = -8.1\text{ A}, R_G = 1\ \Omega$		8.0		ns
Rise Time	t_r			19		
Turn-Off Delay Time	$t_{d(OFF)}$			78		
Fall Time	t_f			50		

DRAIN-SOURCE DIODE CHARACTERISTICS

Forward Diode Voltage	V_{SD}	$V_{GS} = 0\text{ V},$ $I_S = -1.0\text{ A}$	$T_J = 25^\circ\text{C}$		-0.6	-1.0	V
			$T_J = 85^\circ\text{C}$		-0.58		
Reverse Recovery Time	t_{RR}	$V_{GS} = 0\text{ V}, d_{ISD}/d_t = 100\text{ A}/\mu\text{s},$ $I_S = -1.0\text{ A}$		55	85	ns	
Charge Time	t_a			18			
Discharge Time	t_b			37			
Reverse Recovery Charge	Q_{RR}			39			nC

5. Pulse Test: pulse width $\leq 300\ \mu\text{s}$, duty cycle $\leq 2\%$

6. Switching characteristics are independent of operating junction temperatures

ORDERING INFORMATION

Device	Package	Shipping [†]
NTLJS1102PTBG	WDFN6 (Pb-Free)	3000 / Tape & Reel
NTLJS1102PTAG	WDFN6 (Pb-Free)	3000 / Tape & Reel

[†]For information on tape and reel specifications, including part orientation and tape sizes, please refer to our Tape and Reel Packaging Specifications Brochure, BRD8011/D.

TYPICAL CHARACTERISTICS

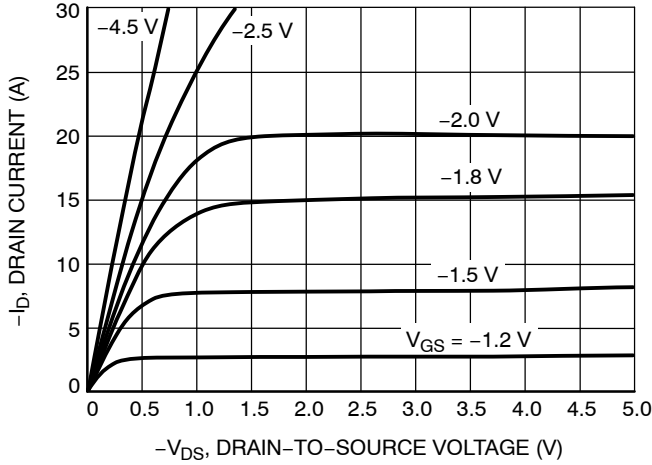

Figure 1. On-Region Characteristics

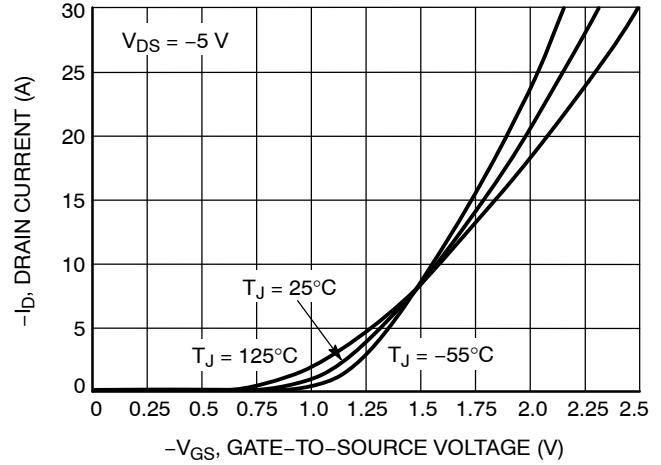

Figure 2. Transfer Characteristics

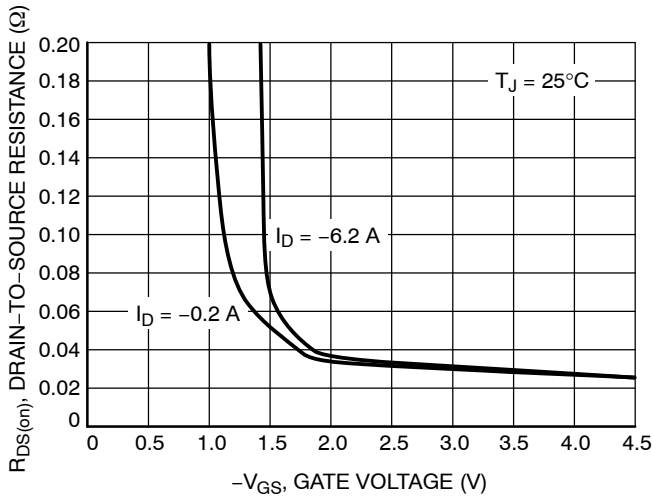

Figure 3. On-Resistance vs. Gate-to-Source Voltage

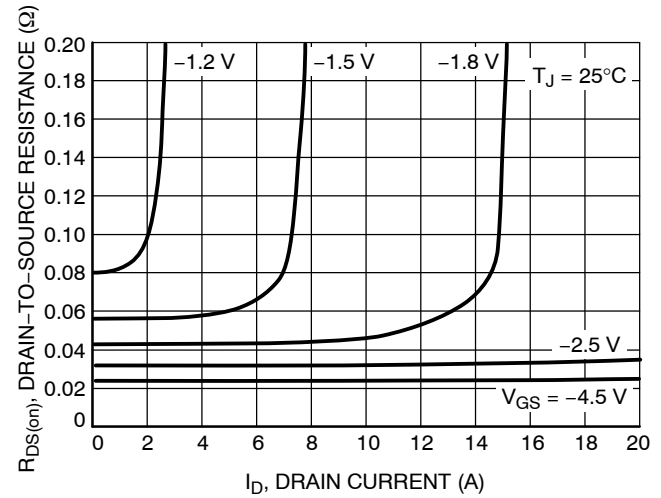

Figure 4. On-Resistance vs. Drain Current and Gate Voltage

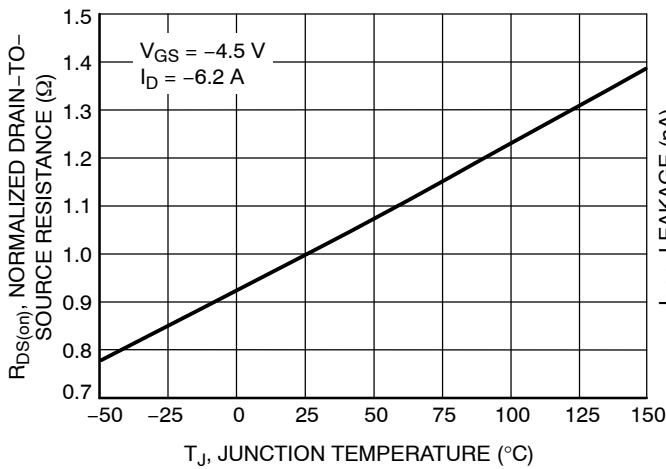

Figure 5. On-Resistance Variation with Temperature

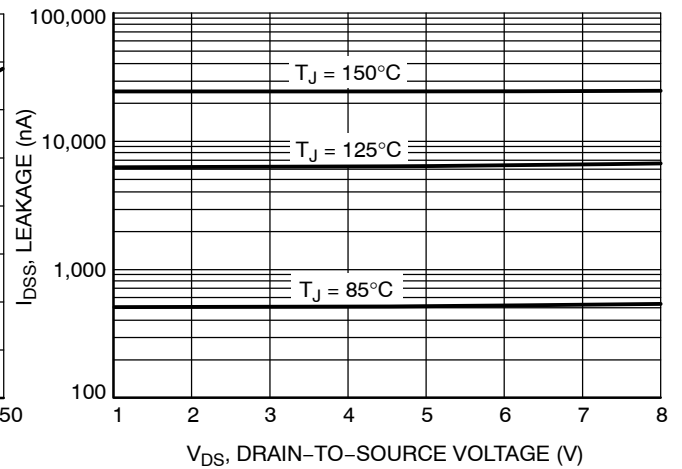

Figure 6. Drain-to-Source Leakage Current vs. Voltage

TYPICAL CHARACTERISTICS

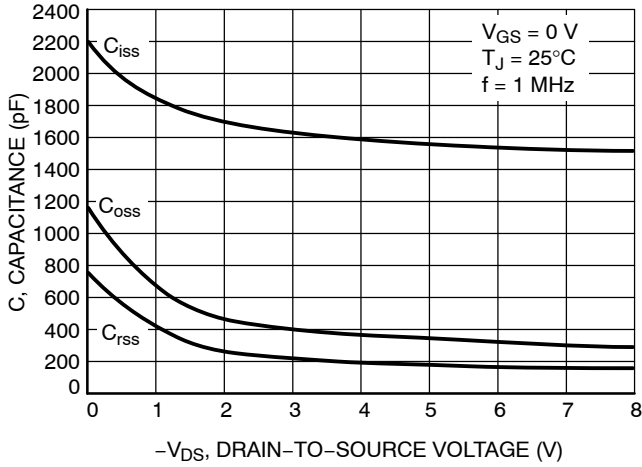

Figure 7. Capacitance Variation

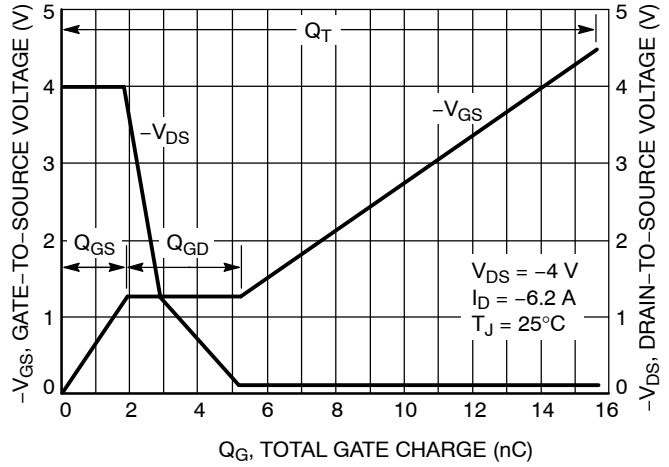

Figure 8. Gate-to-Source and Drain-to-Source Voltage vs. Total Charge

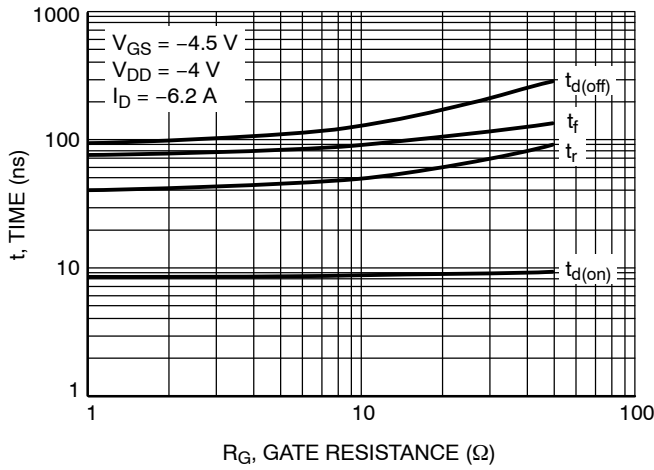

Figure 9. Resistive Switching Time Variation vs. Gate Resistance

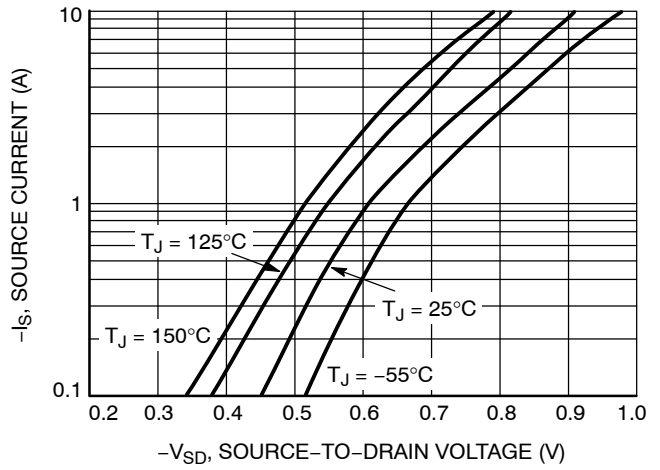

Figure 10. Diode Forward Voltage vs. Current

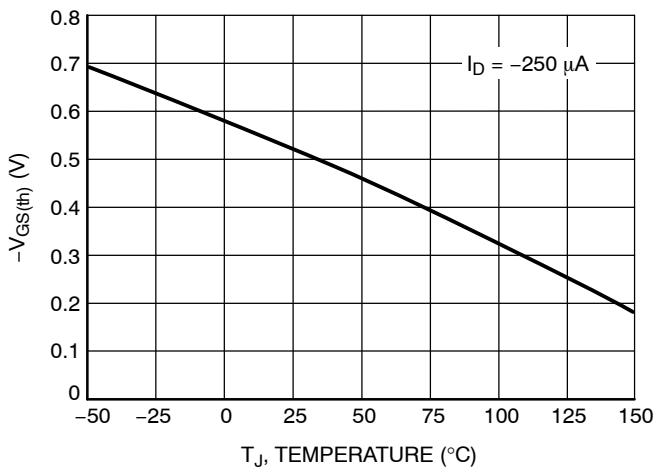

Figure 11. Threshold Voltage

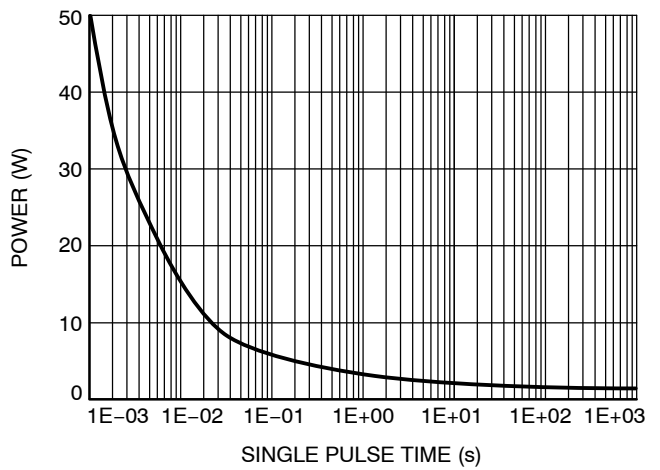

Figure 12. Single Pulse Maximum Power Dissipation

NTLJS1102P

TYPICAL CHARACTERISTICS

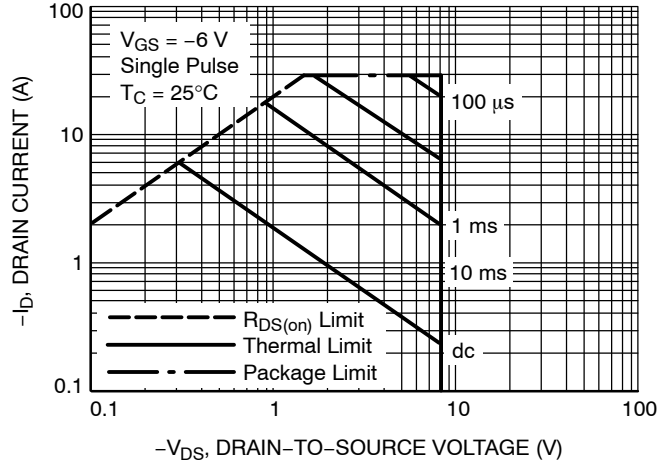

Figure 13. Maximum Rated Forward Biased Safe Operating Area

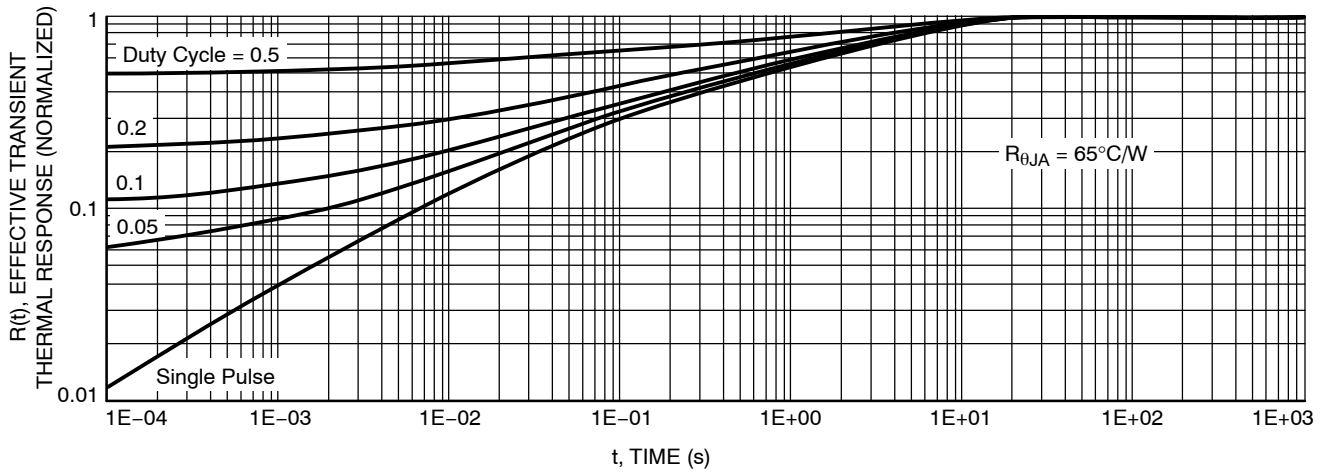

Figure 14. FET Thermal Response

MECHANICAL CASE OUTLINE

PACKAGE DIMENSIONS

ON Semiconductor®



WDFN6 2x2 CASE 506AP-01 ISSUE B

DATE 26 APR 2006

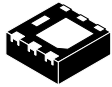

SCALE 4:1

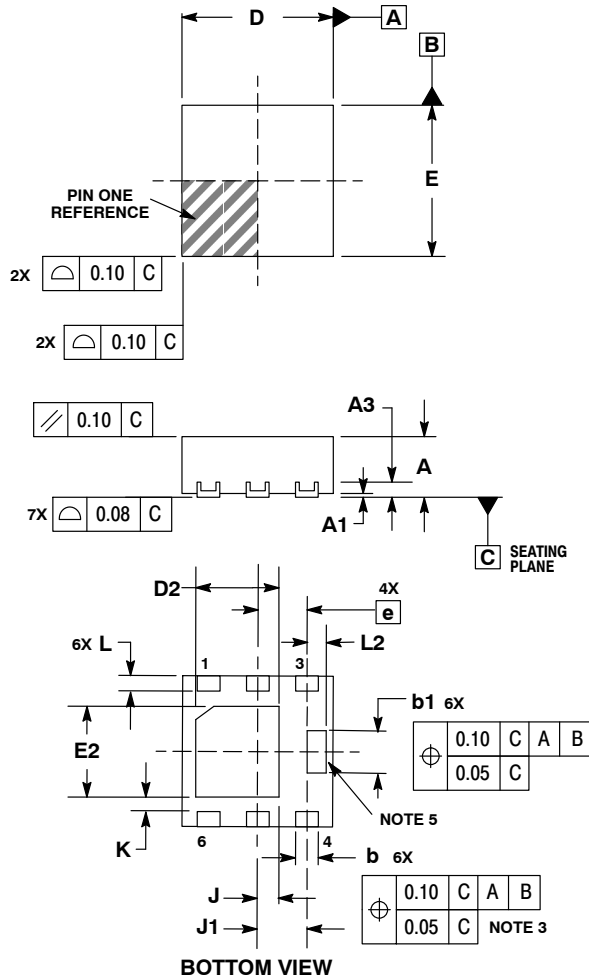

STYLE 1:
PIN 1. DRAIN
2. DRAIN
3. GATE
4. SOURCE
5. DRAIN
6. DRAIN

STYLE 2:
PIN 1. COLLECTOR
2. COLLECTOR
3. BASE
4. EMITTER
5. COLLECTOR
6. COLLECTOR

NOTES:

1. DIMENSIONING AND TOLERANCING PER ASME Y14.5M, 1994.
2. CONTROLLING DIMENSION: MILLIMETERS.
3. DIMENSION b APPLIES TO PLATED TERMINAL AND IS MEASURED BETWEEN 0.15 AND 0.20mm FROM TERMINAL.
4. COPLANARITY APPLIES TO THE EXPOSED PAD AS WELL AS THE TERMINALS.
1. CENTER TERMINAL LEAD IS OPTIONAL. TERMINAL LEAD IS CONNECTED TO TERMINAL LEAD # 4.
2. PINS 1, 2, 5 AND 6 ARE TIED TO THE FLAG.

DIM	MILLIMETERS	
	MIN	MAX
A	0.70	0.80
A1	0.00	0.05
A3	0.20 REF	
b	0.25	0.35
b1	0.51	0.61
D	2.00 BSC	
D2	1.00	1.20
E	2.00 BSC	
E2	1.10	1.30
e	0.65 BSC	
K	0.15 REF	
L	0.20	0.30
L2	0.20	0.30
J	0.27 REF	
J1	0.65 REF	

GENERIC MARKING DIAGRAM*

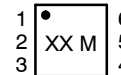

XX = Specific Device Code
M = Date Code

*This information is generic. Please refer to device data sheet for actual part marking. Pb-Free indicator, "G" or microdot "•", may or may not be present.

SOLDERMASK DEFINED MOUNTING FOOTPRINT

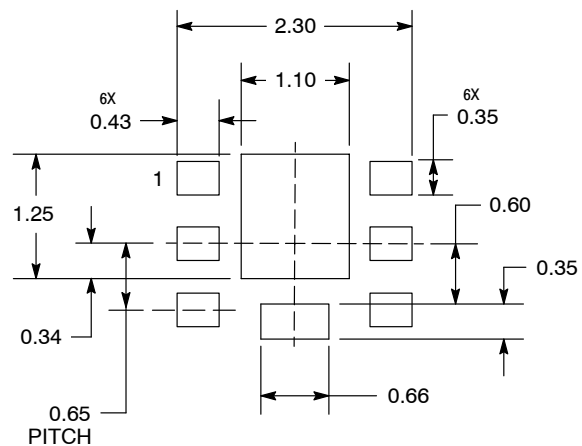

DIMENSIONS: MILLIMETERS

DOCUMENT NUMBER:	98AON20860D	Electronic versions are uncontrolled except when accessed directly from the Document Repository. Printed versions are uncontrolled except when stamped "CONTROLLED COPY" in red.
DESCRIPTION:	6 PIN WDFN 2X2, 0.65P	PAGE 1 OF 1

ON Semiconductor and ON are trademarks of Semiconductor Components Industries, LLC dba ON Semiconductor or its subsidiaries in the United States and/or other countries. ON Semiconductor reserves the right to make changes without further notice to any products herein. ON Semiconductor makes no warranty, representation or guarantee regarding the suitability of its products for any particular purpose, nor does ON Semiconductor assume any liability arising out of the application or use of any product or circuit, and specifically disclaims any and all liability, including without limitation special, consequential or incidental damages. ON Semiconductor does not convey any license under its patent rights nor the rights of others.

onsemi, **Onsemi**, and other names, marks, and brands are registered and/or common law trademarks of Semiconductor Components Industries, LLC dba "**onsemi**" or its affiliates and/or subsidiaries in the United States and/or other countries. **onsemi** owns the rights to a number of patents, trademarks, copyrights, trade secrets, and other intellectual property. A listing of **onsemi**'s product/patent coverage may be accessed at www.onsemi.com/site/pdf/Patent-Marking.pdf. **onsemi** reserves the right to make changes at any time to any products or information herein, without notice. The information herein is provided "as-is" and **onsemi** makes no warranty, representation or guarantee regarding the accuracy of the information, product features, availability, functionality, or suitability of its products for any particular purpose, nor does **onsemi** assume any liability arising out of the application or use of any product or circuit, and specifically disclaims any and all liability, including without limitation special, consequential or incidental damages. Buyer is responsible for its products and applications using **onsemi** products, including compliance with all laws, regulations and safety requirements or standards, regardless of any support or applications information provided by **onsemi**. "Typical" parameters which may be provided in **onsemi** data sheets and/or specifications can and do vary in different applications and actual performance may vary over time. All operating parameters, including "Typicals" must be validated for each customer application by customer's technical experts. **onsemi** does not convey any license under any of its intellectual property rights nor the rights of others. **onsemi** products are not designed, intended, or authorized for use as a critical component in life support systems or any FDA Class 3 medical devices or medical devices with a same or similar classification in a foreign jurisdiction or any devices intended for implantation in the human body. Should Buyer purchase or use **onsemi** products for any such unintended or unauthorized application, Buyer shall indemnify and hold **onsemi** and its officers, employees, subsidiaries, affiliates, and distributors harmless against all claims, costs, damages, and expenses, and reasonable attorney fees arising out of, directly or indirectly, any claim of personal injury or death associated with such unintended or unauthorized use, even if such claim alleges that **onsemi** was negligent regarding the design or manufacture of the part. **onsemi** is an Equal Opportunity/Affirmative Action Employer. This literature is subject to all applicable copyright laws and is not for resale in any manner.

ADDITIONAL INFORMATION

TECHNICAL PUBLICATIONS:

Technical Library: www.onsemi.com/design/resources/technical-documentation
onsemi Website: www.onsemi.com

ONLINE SUPPORT: www.onsemi.com/support

For additional information, please contact your local Sales Representative at www.onsemi.com/support/sales