

# NTGS4111P, NVGS4111P

## MOSFET – Power, Single, P-Channel, TSOP-6

**-30 V, -4.7 A**

### Features

- Leading -30 V Trench Process for Low  $R_{DS(on)}$
- Low Profile Package Suitable for Portable Applications
- Surface Mount TSOP-6 Package Saves Board Space
- Improved Efficiency for Battery Applications
- NV Prefix for Automotive and Other Applications Requiring Unique Site and Control Change Requirements; AEC-Q101 Qualified and PPAP Capable
- Pb-Free Package is Available

### Applications

- Battery Management and Switching
- Load Switching
- Battery Protection

### MAXIMUM RATINGS ( $T_J = 25^\circ\text{C}$ unless otherwise noted)

| Rating  |                         | Symbol                   | Value                    | Unit             |   |
|---|-------------------------|--------------------------|--------------------------|------------------|---|
| Drain-to-Source Voltage   |                         | $V_{DS}$                 | -30                      | V                |   |
| Gate-to-Source Voltage  |                         | $V_{GS}$                 | $\pm 20$                 | V                |   |
| Continuous Drain Current (Note 1)                                 | Steady State            | $T_A = 25^\circ\text{C}$ | $I_D$                    | -3.7             | A |
|   |                         |                          | $T_A = 85^\circ\text{C}$ | -2.7             |   |
|   | $t \leq 5\text{ s}$     | $T_A = 25^\circ\text{C}$ | -4.7                     |                  |   |
| Power Dissipation (Note 1)  | Steady State            | $T_A = 25^\circ\text{C}$ | $P_D$                    | 1.25             | W |
|   | $t \leq 5\text{ s}$     |                          | 2.0                      |                  |   |
| Continuous Drain Current (Note 2)                                 | Steady State            | $T_A = 25^\circ\text{C}$ | $I_D$                    | -2.6             | A |
|   |                         | $T_A = 85^\circ\text{C}$ | -1.9                     |                  |   |
|   |                         | $T_A = 25^\circ\text{C}$ | $P_D$                    | 0.63             |   |
| Power Dissipation (Note 2)  |                         |                          |                          |                  |   |
| Pulsed Drain Current  | $t_p = 10\ \mu\text{s}$ | $I_{DM}$                 | -15                      | A                |   |
| Operating Junction and Storage Temperature                        |                         | $T_J, T_{STG}$           | -55 to 150               | $^\circ\text{C}$ |   |
| Source Current (Body Diode)                                       |                         | $I_S$                    | -1.7                     | A                |   |
| Lead Temperature for Soldering Purposes (1/8" from case for 10 s) |                         | $T_L$                    | 260                      | $^\circ\text{C}$ |   |

### THERMAL RESISTANCE RATINGS

| Rating   | Symbol          | Max  | Unit                      |
|--|-----------------|------|---------------------------|
| Junction-to-Ambient – Steady State (Note 1)        | $R_{\theta JA}$ | 100  | $^\circ\text{C}/\text{W}$ |
| Junction-to-Ambient – $t \leq 5\text{ s}$ (Note 1) | $R_{\theta JA}$ | 62.5 |                           |
| Junction-to-Ambient – Steady State (Note 2)        | $R_{\theta JA}$ | 200  |                           |

Stresses exceeding those listed in the Maximum Ratings table may damage the device. If any of these limits are exceeded, device functionality should not be assumed, damage may occur and reliability may be affected.

1. Surface-mounted on FR4 board using 1 in sq pad size (Cu area = 1.127 in sq [1 oz] including traces).



**ON Semiconductor®**

<http://onsemi.com>

| $V_{(BR)DSS}$ | $R_{DS(on)}$ TYP       | $I_D$ MAX |
|---------------|------------------------|-----------|
| -30 V         | 38 m $\Omega$ @ -10 V  | -4.7 A    |
|               | 68 m $\Omega$ @ -4.5 V |           |

### P-Channel

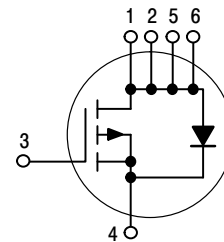

### MARKING DIAGRAM & PIN ASSIGNMENT



**TSOP-6  
CASE 318G  
STYLE 1**

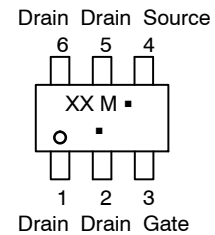

- XX = Specific Device Code
- M = Date Code\*
- = Pb-Free Package

(Note: Microdot may be in either location)

\*Date Code orientation may vary depending upon manufacturing location.

### ORDERING INFORMATION

See detailed ordering and shipping information on page 6 of this data sheet.

## NTGS4111P, NVGS4111P

2. Surface-mounted on FR4 board using the minimum recommended pad size (Cu area = 0.006 in sq).

# NTGS4111P, NVGS4111P

## ELECTRICAL CHARACTERISTICS (T<sub>J</sub> = 25°C unless otherwise noted)

| Characteristic  | Symbol                               | Test Condition                                    | Min                    | Typ | Max  | Unit  |
|---|--------------------------------------|---|------------------------|-----|------|-------|
| <b>OFF CHARACTERISTICS</b>                                |                                      |   |                        |     |      |       |
| Drain-to-Source Breakdown Voltage                         | V <sub>(BR)DSS</sub>                 | V <sub>GS</sub> = 0 V, I <sub>D</sub> = -250 μA   | -30                    |     |      | V     |
| Drain-to-Source Breakdown Voltage Temperature Coefficient | V <sub>(BR)DSS</sub> /T <sub>J</sub> |   |                        | -17 |      | mV/°C |
| Zero Gate Voltage Drain Current                           | I <sub>DSS</sub>                     | V <sub>GS</sub> = 0 V,<br>V <sub>DS</sub> = -24 V | T <sub>J</sub> = 25°C  |     | -1.0 | μA    |
|   |                                      |   | T <sub>J</sub> = 125°C |     | -100 |       |
| Gate-to-Source Leakage Current                            | I <sub>GSS</sub>                     | V <sub>DS</sub> = 0 V, V <sub>GS</sub> = ±20 V    |                        |     | ±100 | nA    |

## ON CHARACTERISTICS (Note 3)

|  |                                     |  |      |     |      |       |
|--|-------------------------------------|--|------|-----|------|-------|
| Gate Threshold Voltage                     | V <sub>GS(TH)</sub>                 | V <sub>GS</sub> = V <sub>DS</sub> , I <sub>D</sub> = -250 μA | -1.0 |     | -3.0 | V     |
| Negative Threshold Temperature Coefficient | V <sub>GS(TH)</sub> /T <sub>J</sub> |  |      | 5.0 |      | mV/°C |
| Drain-to-Source On Resistance              | R <sub>DS(on)</sub>                 | V <sub>GS</sub> = -10 V, I <sub>D</sub> = -3.7 A             |      | 38  | 60   | mΩ    |
|  |                                     | V <sub>GS</sub> = -4.5 V, I <sub>D</sub> = -2.7 A            |      | 68  | 110  |       |
| Forward Transconductance                   | g <sub>FS</sub>                     | V <sub>DS</sub> = -10 V, I <sub>D</sub> = -3.7 A             |      | 6.0 |      | S     |

## CHARGES, CAPACITANCES AND GATE RESISTANCE

|                              |                     |  |  |       |    |    |
|------------------------------|---------------------|--|--|-------|----|----|
| Input Capacitance            | C <sub>ISS</sub>    | V <sub>GS</sub> = 0 V, f = 1.0 MHz,<br>V <sub>DS</sub> = -15 V               |  | 750   |    | pF |
| Output Capacitance           | C <sub>OSS</sub>    |  |  | 140   |    |    |
| Reverse Transfer Capacitance | C <sub>RSS</sub>    |  |  | 105   |    |    |
| Total Gate Charge            | Q <sub>G(TOT)</sub> | V <sub>GS</sub> = -10 V, V <sub>DD</sub> = -15 V,<br>I <sub>D</sub> = -3.7 A |  | 15.25 | 32 | nC |
| Threshold Gate Charge        | Q <sub>G(TH)</sub>  |  |  | 0.8   |    |    |
| Gate-to-Source Charge        | Q <sub>GS</sub>     |  |  | 2.6   |    |    |
| Gate-to-Drain Charge         | Q <sub>GD</sub>     |  |  | 3.4   |    |    |

## SWITCHING CHARACTERISTICS, V<sub>GS</sub> = -10 V (Note 4)

|                     |                     |  |  |     |    |    |
|---------------------|---------------------|--|--|-----|----|----|
| Turn-On Delay Time  | t <sub>d(ON)</sub>  | V <sub>GS</sub> = -10 V, V <sub>DD</sub> = -15 V,<br>I <sub>D</sub> = -1.0 A, R <sub>G</sub> = 6.0 Ω |  | 9.0 | 17 | ns |
| Rise Time           | t <sub>r</sub>      |  |  | 9.0 | 18 |    |
| Turn-Off Delay Time | t <sub>d(OFF)</sub> |  |  | 38  | 85 |    |
| Fall Time           | t <sub>f</sub>      |  |  | 22  | 45 |    |

## SWITCHING CHARACTERISTICS, V<sub>GS</sub> = -4.5 V (Note 4)

|                     |                     |   |  |    |    |    |
|---------------------|---------------------|---|--|----|----|----|
| Turn-On Delay Time  | t <sub>d(ON)</sub>  | V <sub>GS</sub> = -4.5 V, V <sub>DD</sub> = -15 V,<br>I <sub>D</sub> = -1.0 A, R <sub>G</sub> = 6.0 Ω |  | 11 | 20 | ns |
| Rise Time           | t <sub>r</sub>      |   |  | 15 | 28 |    |
| Turn-Off Delay Time | t <sub>d(OFF)</sub> |   |  | 28 | 56 |    |
| Fall Time           | t <sub>f</sub>      |   |  | 22 | 50 |    |

## DRAIN - SOURCE DIODE CHARACTERISTICS

| Characteristic          | Symbol          | Test Condition   | Min                    | Typ   | Max  | Unit |
|-------------------------|-----------------|--|------------------------|-------|------|------|
| Forward Diode Voltage   | V <sub>DS</sub> | V <sub>GS</sub> = 0 V,<br>I <sub>S</sub> = -1.0 A                                | T <sub>J</sub> = 25°C  | -0.76 | -1.2 | V    |
|                         |                 |  | T <sub>J</sub> = 125°C | -0.60 |      |      |
| Reverse Recovery Time   | t <sub>RR</sub> | V <sub>GS</sub> = 0 V<br>dI <sub>S</sub> /dt = 100 A/μs, I <sub>S</sub> = -1.0 A |                        | 17    | 40   | ns   |
| Charge Time             | t <sub>a</sub>  |  |                        | 9.0   |      |      |
| Discharge Time          | t <sub>b</sub>  |  |                        | 8.0   |      |      |
| Reverse Recovery Charge | Q <sub>RR</sub> |  |                        | 8.0   |      | nC   |

Product parametric performance is indicated in the Electrical Characteristics for the listed test conditions, unless otherwise noted. Product performance may not be indicated by the Electrical Characteristics if operated under different conditions.

3. Pulse Test: pulse width ≤ 300 μs, duty cycle ≤ 2%.

4. Switching characteristics are independent of operating junction temperatures.

# NTGS4111P, NVGS4111P

## TYPICAL PERFORMANCE CURVES ( $T_J = 25^\circ\text{C}$ unless otherwise noted)

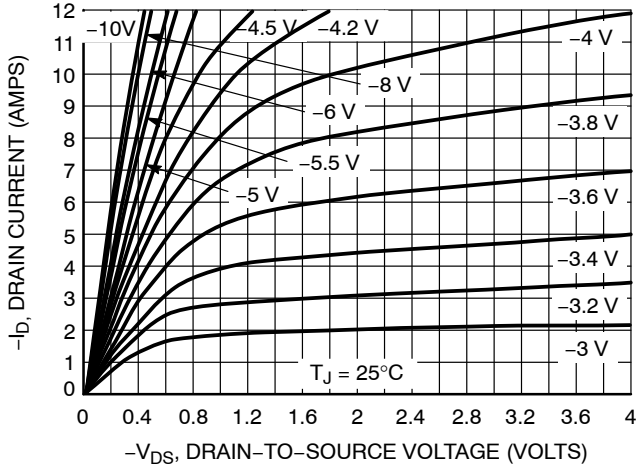

Figure 1. On-Region Characteristics

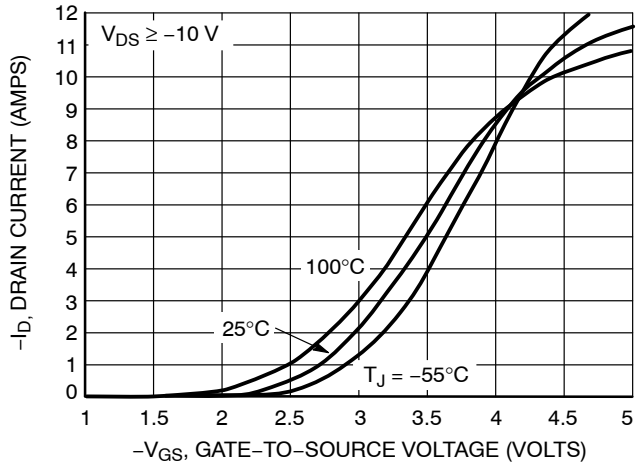

Figure 2. Transfer Characteristics

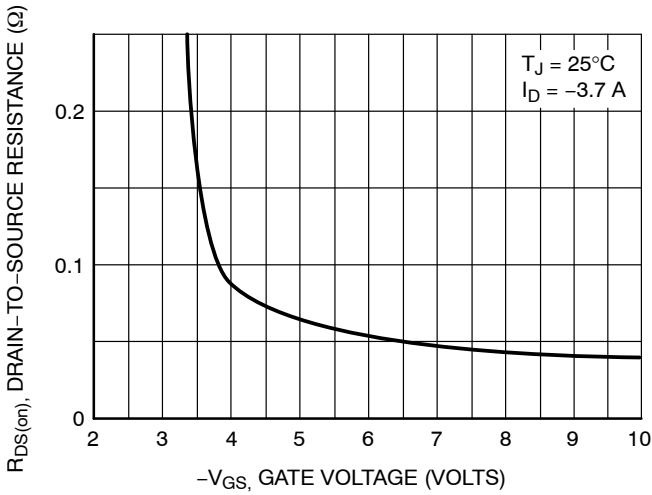

Figure 3. On-Resistance vs. Gate-to-Source Voltage

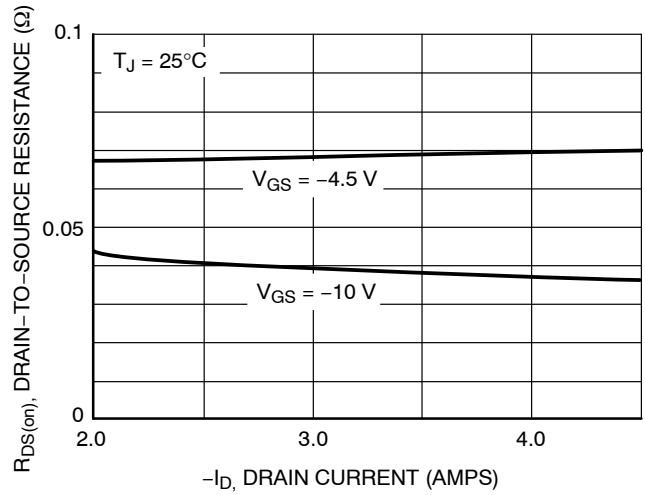

Figure 4. On-Resistance vs. Drain Current and Gate Voltage

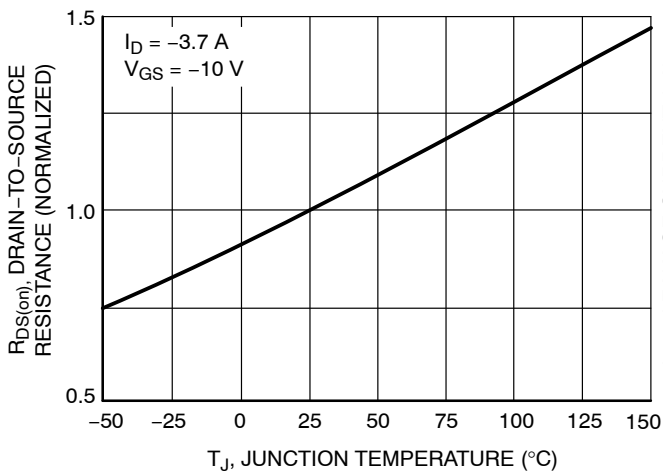

Figure 5. On-Resistance Variation with Temperature

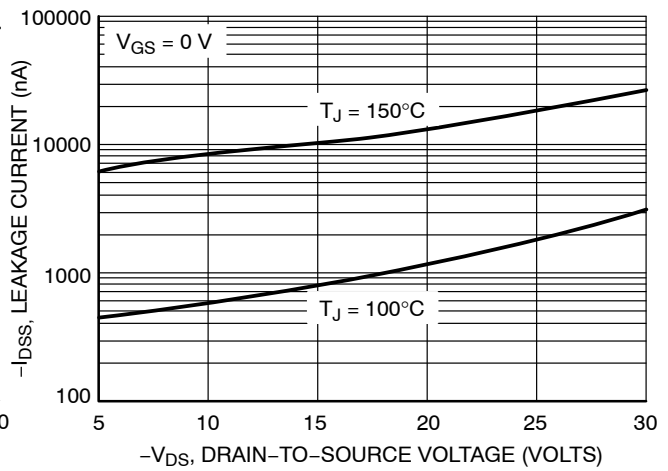

Figure 6. Drain-to-Source Leakage Current vs. Voltage

# NTGS4111P, NVGS4111P

## TYPICAL PERFORMANCE CURVES ( $T_J = 25^\circ\text{C}$ unless otherwise noted)

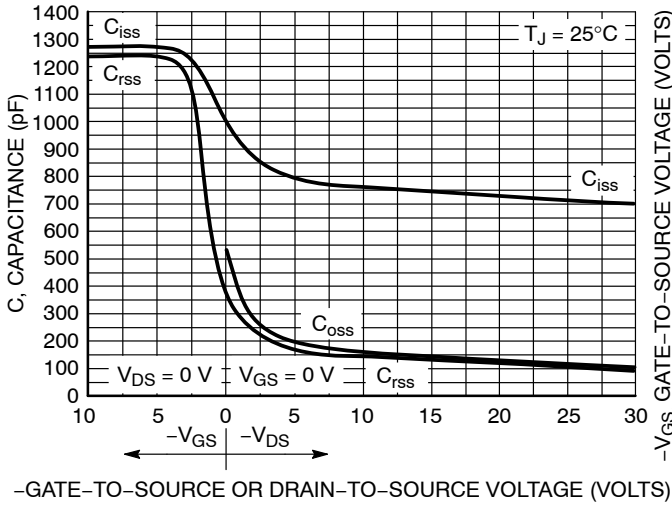

Figure 7. Capacitance Variation

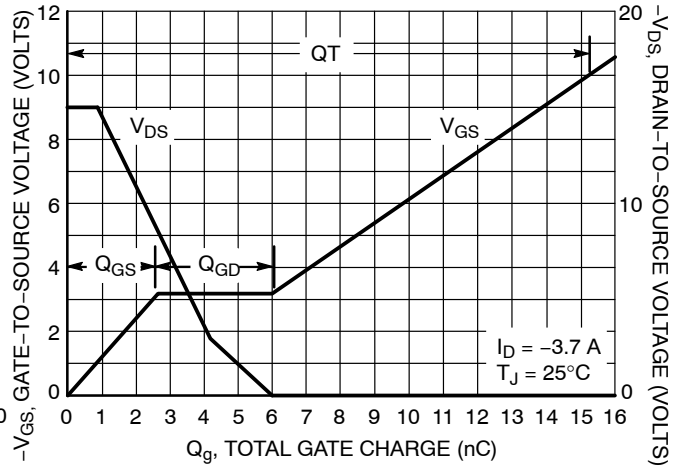

Figure 8. Gate-to-Source Voltage vs. Total Gate Charge

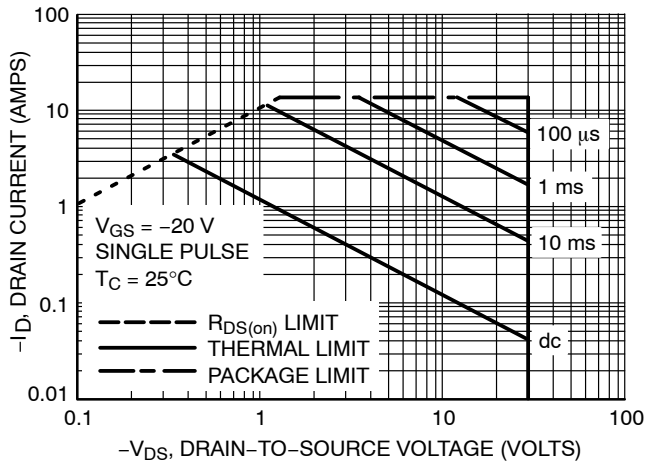

Figure 9. Maximum Rated Forward Biased Safe Operating Area

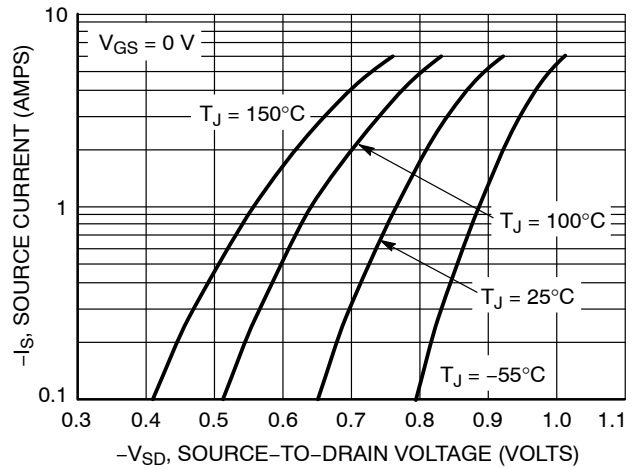

Figure 10. Diode Forward Voltage vs. Current

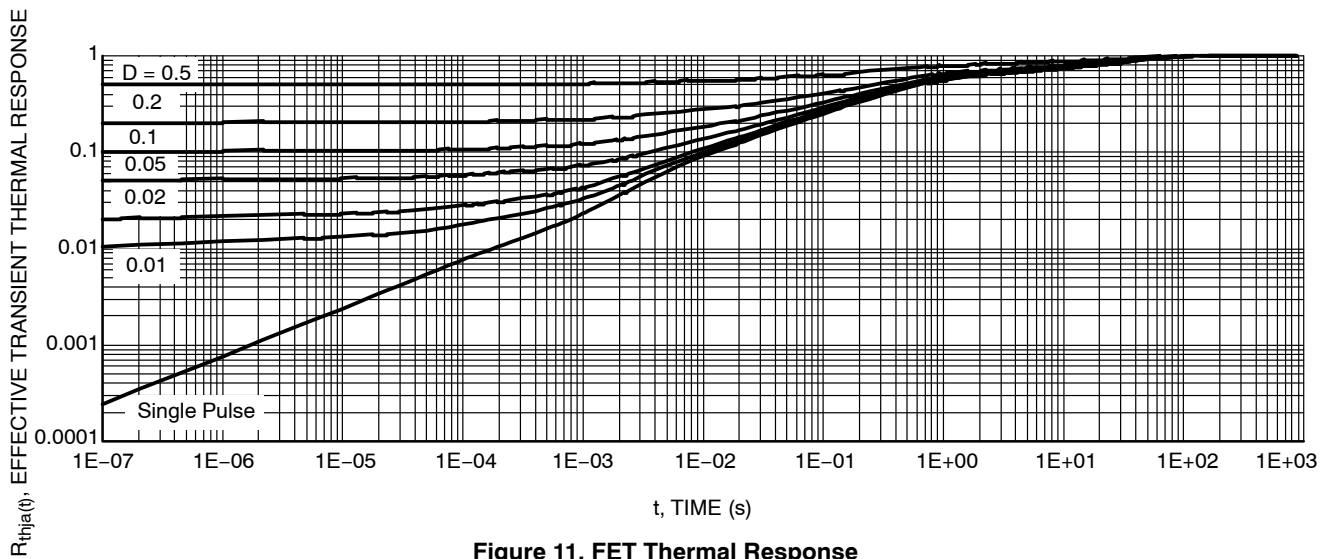

Figure 11. FET Thermal Response

# NTGS4111P, NVGS4111P

**Table 1. ORDERING INFORMATION**

| <b>Part Number</b> | <b>Marking<br/>(XX)</b> | <b>Package</b>     | <b>Shipping<sup>†</sup></b> |
|--------------------|-------------------------|--------------------|-----------------------------|
| NTGS4111PT1        | TG                      | SC-88              | 3000 / Tape & Reel          |
| NTGS4111PT1G       | TG                      | SC-88<br>(Pb-Free) | 3000 / Tape & Reel          |
| NVGS4111PT1G       | VTG                     | SC-88<br>(Pb-Free) | 3000 / Tape & Reel          |

<sup>†</sup>For information on tape and reel specifications, including part orientation and tape sizes, please refer to our Tape and Reel Packaging Specifications Brochure, BRD8011/D.

# MECHANICAL CASE OUTLINE PACKAGE DIMENSIONS

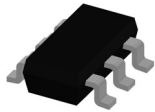

**TSOP-6 3.00x1.50x0.90, 0.95P**  
**CASE 318G**  
**ISSUE W**

DATE 26 FEB 2024

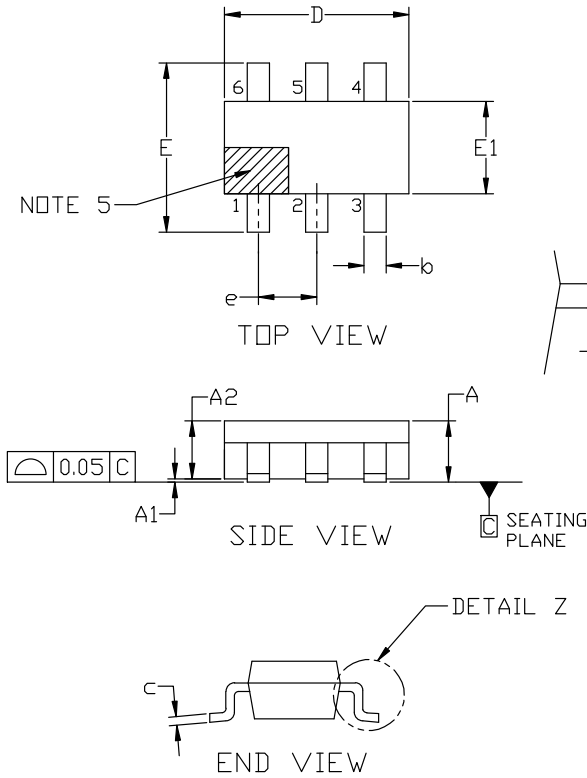

**NOTES:**

1. DIMENSIONING AND TOLERANCING PER ASME Y14.5M, 2018.
2. CONTROLLING DIMENSION: MILLIMETERS.
3. MAXIMUM LEAD THICKNESS INCLUDES LEAD FINISH. MINIMUM LEAD THICKNESS IS THE MINIMUM THICKNESS OF BASE MATERIAL.
4. DIMENSIONS D AND E1 DO NOT INCLUDE MOLD FLASH, PROTRUSIONS, OR GATE BURRS. MOLD FLASH, PROTRUSIONS, OR GATE BURRS SHALL NOT EXCEED 0.15 PER SIDE. DIMENSIONS D AND E1 ARE DETERMINED AT DATUM H.
5. PIN 1 INDICATOR MUST BE LOCATED IN THE INDICATED ZONE

| MILLIMETERS |          |      |      |
|-------------|----------|------|------|
| DIM         | MIN      | NOM  | MAX  |
| A           | 0.90     | 1.00 | 1.10 |
| A1          | 0.01     | 0.06 | 0.10 |
| A2          | 0.80     | 0.90 | 1.00 |
| b           | 0.25     | 0.38 | 0.50 |
| c           | 0.10     | 0.18 | 0.26 |
| D           | 2.90     | 3.00 | 3.10 |
| E           | 2.50     | 2.75 | 3.00 |
| E1          | 1.30     | 1.50 | 1.70 |
| e           | 0.85     | 0.95 | 1.05 |
| L           | 0.20     | 0.40 | 0.60 |
| L2          | 0.25 BSC |      |      |
| M           | 0°       | ---  | 10°  |

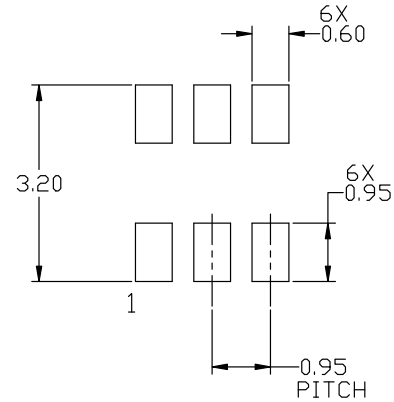

**RECOMMENDED MOUNTING FOOTPRINT**

\*For additional information on our Pb-Free strategy and soldering details, please download the ON Semiconductor Soldering and Mounting Techniques Reference manual, SOLDERRM/D.

|                         |                                     |  |
|-------------------------|-------------------------------------|--|
| <b>DOCUMENT NUMBER:</b> | <b>98ASB14888C</b>                  | Electronic versions are uncontrolled except when accessed directly from the Document Repository. Printed versions are uncontrolled except when stamped "CONTROLLED COPY" in red. |
| <b>DESCRIPTION:</b>     | <b>TSOP-6 3.00x1.50x0.90, 0.95P</b> | <b>PAGE 1 OF 2</b>   |

onsemi and ONSEMI are trademarks of Semiconductor Components Industries, LLC dba onsemi or its subsidiaries in the United States and/or other countries. onsemi reserves the right to make changes without further notice to any products herein. onsemi makes no warranty, representation or guarantee regarding the suitability of its products for any particular purpose, nor does onsemi assume any liability arising out of the application or use of any product or circuit, and specifically disclaims any and all liability, including without limitation special, consequential or incidental damages. onsemi does not convey any license under its patent rights nor the rights of others.

# MECHANICAL CASE OUTLINE

## PACKAGE DIMENSIONS



TSOP-6 3.00x1.50x0.90, 0.95P  
CASE 318G  
ISSUE W

DATE 26 FEB 2024

### GENERIC MARKING DIAGRAM\*

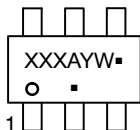

IC

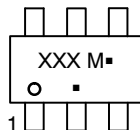

STANDARD

XXX = Specific Device Code  
A = Assembly Location  
Y = Year  
W = Work Week  
▪ = Pb-Free Package

XXX = Specific Device Code  
M = Date Code  
▪ = Pb-Free Package

\*This information is generic. Please refer to device data sheet for actual part marking. Pb-Free indicator, "G" or microdot "▪", may or may not be present. Some products may not follow the Generic Marking.

- |  |  |   |   |   |  |
|--|--|---|---|---|--|
| <p>STYLE 1:<br/>PIN 1. DRAIN<br/>2. DRAIN<br/>3. GATE<br/>4. SOURCE<br/>5. DRAIN<br/>6. DRAIN</p>              | <p>STYLE 2:<br/>PIN 1. EMITTER 2<br/>2. BASE 1<br/>3. COLLECTOR 1<br/>4. EMITTER 1<br/>5. BASE 2<br/>6. COLLECTOR 2</p>    | <p>STYLE 3:<br/>PIN 1. ENABLE<br/>2. N/C<br/>3. R BOOST<br/>4. Vz<br/>5. V in<br/>6. V out</p>                            | <p>STYLE 4:<br/>PIN 1. N/C<br/>2. V in<br/>3. NOT USED<br/>4. GROUND<br/>5. ENABLE<br/>6. LOAD</p>                | <p>STYLE 5:<br/>PIN 1. EMITTER 2<br/>2. BASE 2<br/>3. COLLECTOR 1<br/>4. EMITTER 1<br/>5. BASE 1<br/>6. COLLECTOR 2</p> | <p>STYLE 6:<br/>PIN 1. COLLECTOR<br/>2. COLLECTOR<br/>3. BASE<br/>4. EMITTER<br/>5. COLLECTOR<br/>6. COLLECTOR</p> |
| <p>STYLE 7:<br/>PIN 1. COLLECTOR<br/>2. COLLECTOR<br/>3. BASE<br/>4. N/C<br/>5. COLLECTOR<br/>6. EMITTER</p>   | <p>STYLE 8:<br/>PIN 1. Vbus<br/>2. D(in)<br/>3. D(in)+<br/>4. D(out)+<br/>5. D(out)<br/>6. GND</p>                         | <p>STYLE 9:<br/>PIN 1. LOW VOLTAGE GATE<br/>2. DRAIN<br/>3. SOURCE<br/>4. DRAIN<br/>5. DRAIN<br/>6. HIGH VOLTAGE GATE</p> | <p>STYLE 10:<br/>PIN 1. D(OUT)+<br/>2. GND<br/>3. D(OUT)-<br/>4. D(IN)-<br/>5. VBUS<br/>6. D(IN)+</p>             | <p>STYLE 11:<br/>PIN 1. SOURCE 1<br/>2. DRAIN 2<br/>3. DRAIN 2<br/>4. SOURCE 2<br/>5. GATE 1<br/>6. DRAIN 1/GATE 2</p>  | <p>STYLE 12:<br/>PIN 1. I/O<br/>2. GROUND<br/>3. I/O<br/>4. I/O<br/>5. VCC<br/>6. I/O</p>                          |
| <p>STYLE 13:<br/>PIN 1. GATE 1<br/>2. SOURCE 2<br/>3. GATE 2<br/>4. DRAIN 2<br/>5. SOURCE 1<br/>6. DRAIN 1</p> | <p>STYLE 14:<br/>PIN 1. ANODE<br/>2. SOURCE<br/>3. GATE<br/>4. CATHODE/DRAIN<br/>5. CATHODE/DRAIN<br/>6. CATHODE/DRAIN</p> | <p>STYLE 15:<br/>PIN 1. ANODE<br/>2. SOURCE<br/>3. GATE<br/>4. DRAIN<br/>5. N/C<br/>6. CATHODE</p>                        | <p>STYLE 16:<br/>PIN 1. ANODE/CATHODE<br/>2. BASE<br/>3. EMITTER<br/>4. COLLECTOR<br/>5. ANODE<br/>6. CATHODE</p> | <p>STYLE 17:<br/>PIN 1. EMITTER<br/>2. BASE<br/>3. ANODE/CATHODE<br/>4. ANODE<br/>5. CATHODE<br/>6. COLLECTOR</p>       |  |

|                         |                                     |   |
|-------------------------|-------------------------------------|---|
| <b>DOCUMENT NUMBER:</b> | <b>98ASB14888C</b>                  | Electronic versions are uncontrolled except when accessed directly from the Document Repository.<br>Printed versions are uncontrolled except when stamped "CONTROLLED COPY" in red. |
| <b>DESCRIPTION:</b>     | <b>TSOP-6 3.00x1.50x0.90, 0.95P</b> | <b>PAGE 2 OF 2</b>  |

onsemi and onsemi are trademarks of Semiconductor Components Industries, LLC dba onsemi or its subsidiaries in the United States and/or other countries. onsemi reserves the right to make changes without further notice to any products herein. onsemi makes no warranty, representation or guarantee regarding the suitability of its products for any particular purpose, nor does onsemi assume any liability arising out of the application or use of any product or circuit, and specifically disclaims any and all liability, including without limitation special, consequential or incidental damages. onsemi does not convey any license under its patent rights nor the rights of others.



**onsemi**, **Onsemi**, and other names, marks, and brands are registered and/or common law trademarks of Semiconductor Components Industries, LLC dba "**onsemi**" or its affiliates and/or subsidiaries in the United States and/or other countries. **onsemi** owns the rights to a number of patents, trademarks, copyrights, trade secrets, and other intellectual property. A listing of **onsemi**'s product/patent coverage may be accessed at [www.onsemi.com/site/pdf/Patent-Marking.pdf](http://www.onsemi.com/site/pdf/Patent-Marking.pdf). **onsemi** reserves the right to make changes at any time to any products or information herein, without notice. The information herein is provided "as-is" and **onsemi** makes no warranty, representation or guarantee regarding the accuracy of the information, product features, availability, functionality, or suitability of its products for any particular purpose, nor does **onsemi** assume any liability arising out of the application or use of any product or circuit, and specifically disclaims any and all liability, including without limitation special, consequential or incidental damages. Buyer is responsible for its products and applications using **onsemi** products, including compliance with all laws, regulations and safety requirements or standards, regardless of any support or applications information provided by **onsemi**. "Typical" parameters which may be provided in **onsemi** data sheets and/or specifications can and do vary in different applications and actual performance may vary over time. All operating parameters, including "Typicals" must be validated for each customer application by customer's technical experts. **onsemi** does not convey any license under any of its intellectual property rights nor the rights of others. **onsemi** products are not designed, intended, or authorized for use as a critical component in life support systems or any FDA Class 3 medical devices or medical devices with a same or similar classification in a foreign jurisdiction or any devices intended for implantation in the human body. Should Buyer purchase or use **onsemi** products for any such unintended or unauthorized application, Buyer shall indemnify and hold **onsemi** and its officers, employees, subsidiaries, affiliates, and distributors harmless against all claims, costs, damages, and expenses, and reasonable attorney fees arising out of, directly or indirectly, any claim of personal injury or death associated with such unintended or unauthorized use, even if such claim alleges that **onsemi** was negligent regarding the design or manufacture of the part. **onsemi** is an Equal Opportunity/Affirmative Action Employer. This literature is subject to all applicable copyright laws and is not for resale in any manner.

## ADDITIONAL INFORMATION

### TECHNICAL PUBLICATIONS:

Technical Library: [www.onsemi.com/design/resources/technical-documentation](http://www.onsemi.com/design/resources/technical-documentation)  
onsemi Website: [www.onsemi.com](http://www.onsemi.com)

### ONLINE SUPPORT: [www.onsemi.com/support](http://www.onsemi.com/support)

For additional information, please contact your local Sales Representative at [www.onsemi.com/support/sales](http://www.onsemi.com/support/sales)