

# NJD35N04G, NJVNJD35N04G, NJVNJD35N04T4G

## NPN Darlington Power Transistor

This high voltage power Darlington has been specifically designed for inductive applications such as Electronic Ignition, Switching Regulators and Motor Control.

### Features

- Exceptional Safe Operating Area
- High  $V_{CE}$ ; High Current Gain
- NJV Prefix for Automotive and Other Applications Requiring Unique Site and Control Change Requirements; AEC-Q101 Qualified and PPAP Capable
- These are Pb-Free Devices\*

### Benefits

- Reliable Performance at Higher Powers
- Designed for Inductive Loads
- Very Low Current Requirements

### Applications

- Internal Combustion Engine Ignition Control
- Switching Regulators
- Motor Controls
- Light Ballast
- Photo Flash

### MAXIMUM RATINGS

Rating	Symbol	Value	Unit
Collector-Emitter Sustaining Voltage	$V_{CEO}$	350	Vdc
Collector-Base Breakdown Voltage	$V_{CBO}$	700	Vdc
Collector-Emitter Breakdown Voltage	$V_{CES}$	700	Vdc
Emitter-Base Voltage	$V_{EBO}$	5.0	Vdc
Collector Current Continuous Peak	$I_C$ $I_{CM}$	4.0 8.0	Adc
Base Current	$I_B$	0.5	Adc
Total Power Dissipation @ $T_C = 25^\circ\text{C}$ Derate above $25^\circ\text{C}$	$P_D$	45 0.36	W W/ $^\circ\text{C}$
Operating and Storage Junction Temperature Range	$T_J, T_{stg}$	-65 to +150	$^\circ\text{C}$

Stresses exceeding Maximum Ratings may damage the device. Maximum Ratings are stress ratings only. Functional operation above the Recommended Operating Conditions is not implied. Extended exposure to stresses above the Recommended Operating Conditions may affect device reliability.

\*For additional information on our Pb-Free strategy and soldering details, please download the ON Semiconductor Soldering and Mounting Techniques Reference Manual, SOLDERRM/D.



ON Semiconductor®

<http://onsemi.com>

**DARLINGTON  
POWER TRANSISTORS**  
**4 AMPERES**  
**350 VOLTS**  
**45 WATTS**

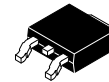

**DPAK  
CASE 369C  
STYLE 1**

### MARKING DIAGRAM

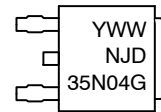

Y = Year  
WW = Work Week  
NJD35N04 = Device Code  
G = Pb-Free Device

### ORDERING INFORMATION

Device	Package	Shipping†
NJD35N04G	DPAK (Pb-Free)	75 Units / Rail
NJVNJD35N04G	DPAK (Pb-Free)	75 Units / Rail
NJD35N04T4G	DPAK (Pb-Free)	2,500 / Tape & Reel
NJVNJD35N04T4G	DPAK (Pb-Free)	2,500 / Tape & Reel

†For information on tape and reel specifications, including part orientation and tape sizes, please refer to our Tape and Reel Packaging Specification Brochure, BRD8011/D.

# NJD35N04G, NJVNJD35N04G, NJVNJD35N04T4G

## THERMAL CHARACTERISTICS

Characteristic	Symbol	Value	Unit
Thermal Resistance Junction-to-Case	$R_{\theta JC}$	2.78	$^{\circ}\text{C}/\text{W}$
Junction-to-Ambient	$R_{\theta JA}$	71.4	

## ELECTRICAL CHARACTERISTICS ( $T_C = 25^{\circ}\text{C}$ unless otherwise noted)

Characteristic	Symbol	Min	Typ	Max	Unit
----------------	--------	-----	-----	-----	------

### OFF CHARACTERISTICS

Collector-Emitter Sustaining Voltage ( $I_C = 10\text{ mA}$ , $L = 10\text{ mH}$ )	$V_{CEO(sus)}$	350	-	-	V
Collector Cutoff Current ( $V_{CE} = 500\text{ V}$ ) ( $I_B = 0$ ) ( $V_{CE} = 500\text{ V}$ , $T_C = 125^{\circ}\text{C}$ )	$I_{CES}$	-	-	50 250	$\mu\text{A}$
Collector Cutoff Current ( $V_{CE} = 250\text{ V}$ ) ( $I_B = 0$ ) ( $V_{CE} = 200\text{ V}$ , $T_C = 125^{\circ}\text{C}$ )	$I_{CEO}$	-	-	50 250	$\mu\text{A}$
Emitter Cutoff Current ( $V_{BE} = 5.0\text{ Vdc}$ )	$I_{EBO}$	-	-	5.0	$\mu\text{A}$

### ON CHARACTERISTICS

Collector-Emitter Saturation Voltage ( $I_C = 2.0\text{ A}$ , $I_B = 20\text{ mA}$ ) ( $I_C = 2.0\text{ A}$ , $I_B = 20\text{ mA}$ $125^{\circ}\text{C}$ )	$V_{CE(sat)}$	-	-	1.5 1.5	V
Base-Emitter Saturation Voltage ( $I_C = 2.0\text{ A}$ , $I_B = 20\text{ mA}$ ) ( $I_C = 2.0\text{ A}$ , $I_B = 20\text{ mA}$ $125^{\circ}\text{C}$ )	$V_{BE(sat)}$	-	-	2.0 2.0	V
Base-Emitter On Voltage ( $I_C = 2.0\text{ A}$ , $V_{CE} = 2.0\text{ V}$ ) ( $I_C = 2.0\text{ A}$ , $V_{CE} = 2.0\text{ V}$ ] $25^{\circ}\text{C}$ )	$V_{BE(on)}$	-	-	2.0 2.0	V
DC Current Gain ( $I_C = 2.0\text{ A}$ , $V_{CE} = 2.0\text{ V}$ ) ( $I_C = 4.0\text{ A}$ , $V_{CE} = 2.0\text{ Vdc}$ )	$h_{FE}$	2000 300	-	-	-

### DYNAMIC CHARACTERISTICS

Current-Gain - Bandwidth Product ( $I_C = 2.0\text{ A}$ , $V_{CE} = 10\text{ V}$ , $f = 1.0\text{ MHz}$ )	$f_T$	90	-	-	MHz
Output Capacitance ( $V_{CB} = 10\text{ V}$ , $I_E = 0$ , $f = 0.1\text{ MHz}$ )	$C_{ob}$	-	60	-	pF

### SWITCHING CHARACTERISTICS

$V_{CC} = 12\text{ V}$ , $V_{clamp} = 250\text{ V}$ , $L = 4\text{ mH}$ $I_C = 2\text{ A}$ , $I_{B1} = 20\text{ mA}$ , $I_{B2} = -20\text{ mA}$	$t_s$ $t_f$	-	18 0.8	-	$\mu\text{Sec}$
--	----------------	---	-----------	---	-----------------

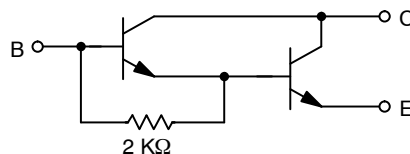

Figure 1. Darlington Circuit Schematic

TYPICAL CHARACTERISTICS

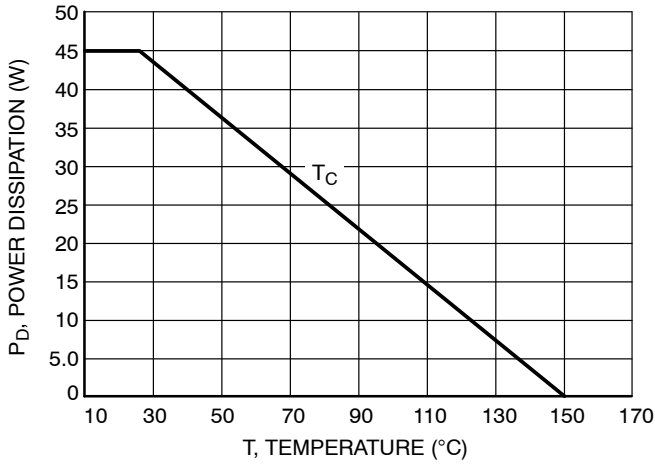

Figure 2. Power Derating

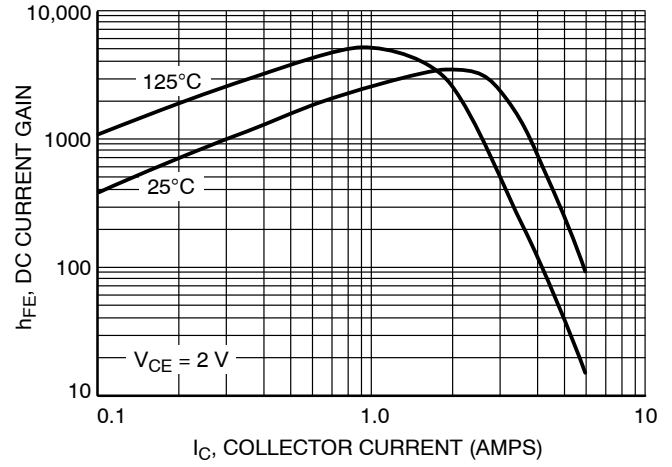

Figure 3. DC Current Gain

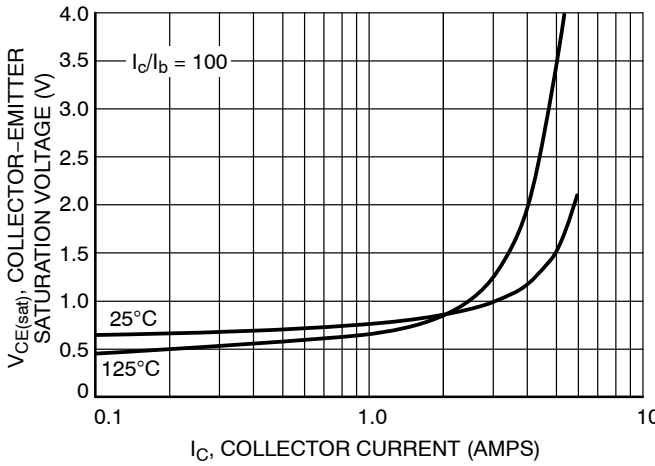

Figure 4. Collector-Emitter Saturation Voltage

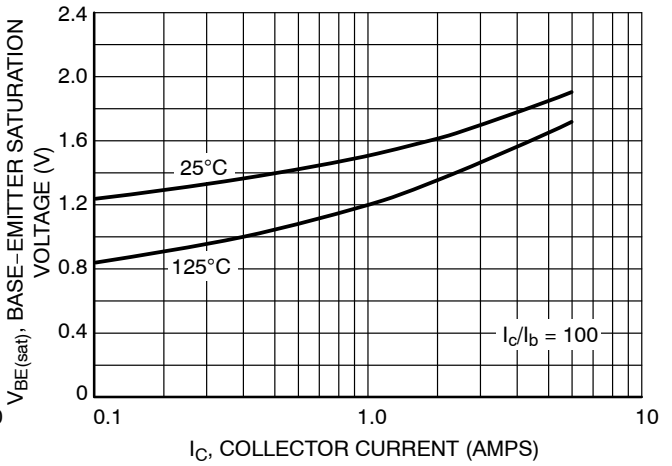

Figure 5. Base-Emitter Saturation Voltage

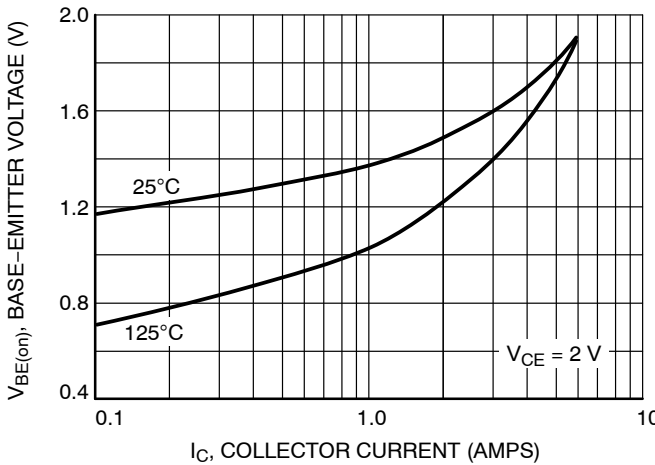

Figure 6. Base-Emitter Voltage

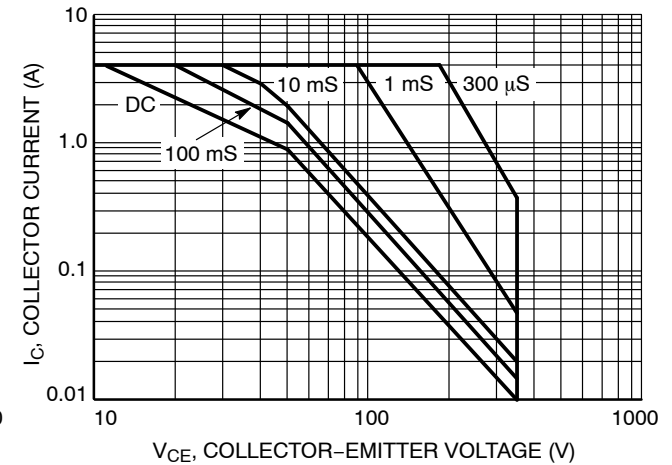
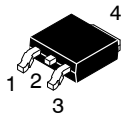

Figure 7. Forward Bias Safe Operating Area (FBSOA)

# MECHANICAL CASE OUTLINE PACKAGE DIMENSIONS



## DPAK (SINGLE GAUGE) CASE 369C ISSUE G

DATE 31 MAY 2023

SCALE 1:1

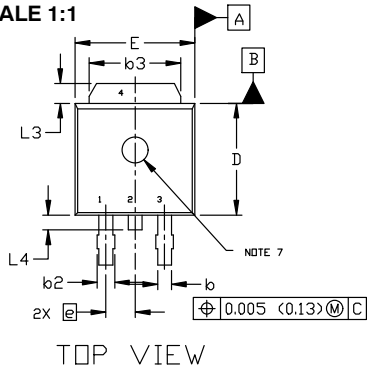

TOP VIEW

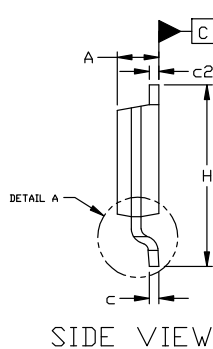

SIDE VIEW

NOTES:

1. DIMENSIONING AND TOLERANCING ASME Y14.5M, 1994.
2. CONTROLLING DIMENSION: INCHES
3. THERMAL PAD CONTOUR OPTIONAL WITHIN DIMENSIONS b3, L3, AND Z.
4. DIMENSIONS D AND E DO NOT INCLUDE MOLD FLASH, PROTRUSIONS, OR BURRS. MOLD FLASH, PROTRUSIONS, OR GATE BURRS SHALL NOT EXCEED 0.006 INCHES PER SIDE.
5. DIMENSIONS D AND E ARE DETERMINED AT THE OUTERMOST EXTREMES OF THE PLASTIC BODY.
6. DATUMS A AND B ARE DETERMINED AT DATUM PLANE H.
7. OPTIONAL MOLD FEATURE.

DIM	INCHES		MILLIMETERS	
	MIN.	MAX.	MIN.	MAX.
A	0.086	0.094	2.18	2.38
A1	0.000	0.005	0.00	0.13
b	0.025	0.035	0.63	0.89
b2	0.028	0.045	0.72	1.14
b3	0.180	0.215	4.57	5.46
c	0.018	0.024	0.46	0.61
c2	0.018	0.024	0.46	0.61
D	0.235	0.245	5.97	6.22
E	0.250	0.265	6.35	6.73
e	0.090	BSC	2.29	BSC
H	0.370	0.410	9.40	10.41
L	0.055	0.070	1.40	1.78
L1	0.114	REF	2.90	REF
L2	0.020	BSC	0.51	BSC
L3	0.035	0.050	0.89	1.27
L4	----	0.040	---	1.01
Z	0.155	----	3.93	---

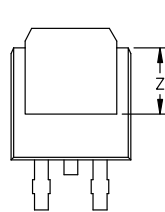

BOTTOM VIEW

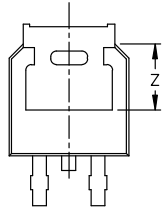

BOTTOM VIEW

ALTERNATE CONSTRUCTIONS

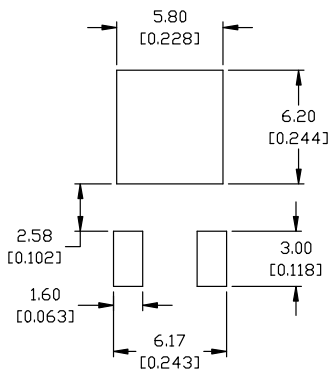

### RECOMMENDED MOUNTING FOOTPRINT\*

\*FOR ADDITIONAL INFORMATION ON OUR Pb-FREE STRATEGY AND SOLDERING DETAILS, PLEASE DOWNLOAD THE ON SEMICONDUCTOR SOLDERING AND MOUNTING TECHNIQUES REFERENCE MANUAL, SOLDERM/D.

- |  |  |   |   |  |
|--|--|---|---|--|
| <b>STYLE 1:</b><br>PIN 1. BASE<br>2. COLLECTOR<br>3. EMITTER<br>4. COLLECTOR | <b>STYLE 2:</b><br>PIN 1. GATE<br>2. DRAIN<br>3. SOURCE<br>4. DRAIN          | <b>STYLE 3:</b><br>PIN 1. ANODE<br>2. CATHODE<br>3. ANODE<br>4. CATHODE | <b>STYLE 4:</b><br>PIN 1. CATHODE<br>2. ANODE<br>3. GATE<br>4. ANODE              | <b>STYLE 5:</b><br>PIN 1. GATE<br>2. ANODE<br>3. CATHODE<br>4. ANODE     |
| <b>STYLE 6:</b><br>PIN 1. MT1<br>2. MT2<br>3. GATE<br>4. MT2                 | <b>STYLE 7:</b><br>PIN 1. GATE<br>2. COLLECTOR<br>3. EMITTER<br>4. COLLECTOR | <b>STYLE 8:</b><br>PIN 1. N/C<br>2. CATHODE<br>3. ANODE<br>4. CATHODE   | <b>STYLE 9:</b><br>PIN 1. ANODE<br>2. CATHODE<br>3. RESISTOR ADJUST<br>4. CATHODE | <b>STYLE 10:</b><br>PIN 1. CATHODE<br>2. ANODE<br>3. CATHODE<br>4. ANODE |

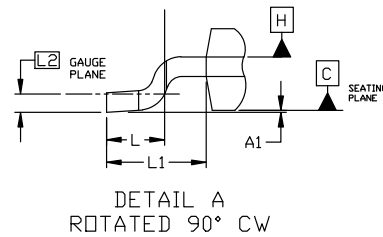

DETAIL A  
ROTATED 90° CW

### GENERIC MARKING DIAGRAM\*

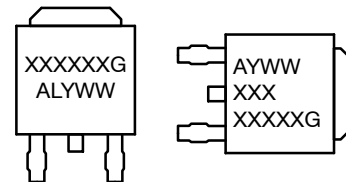

- IC**  
 XXXXXX = Device Code  
 A = Assembly Location  
 L = Wafer Lot  
 Y = Year  
 WW = Work Week  
 G = Pb-Free Package
- Discrete**  
 AYWW = Device Code  
 XXX = Assembly Location  
 XXXXXG = Package Code

\*This information is generic. Please refer to device data sheet for actual part marking. Pb-Free indicator, "G" or microdot "•", may or may not be present. Some products may not follow the Generic Marking.

<b>DOCUMENT NUMBER:</b>	<b>98AON10527D</b>	Electronic versions are uncontrolled except when accessed directly from the Document Repository. Printed versions are uncontrolled except when stamped "CONTROLLED COPY" in red.
<b>DESCRIPTION:</b>	<b>DPAK (SINGLE GAUGE)</b>	<b>PAGE 1 OF 1</b>

onsemi and onsemi are trademarks of Semiconductor Components Industries, LLC dba onsemi or its subsidiaries in the United States and/or other countries. onsemi reserves the right to make changes without further notice to any products herein. onsemi makes no warranty, representation or guarantee regarding the suitability of its products for any particular purpose, nor does onsemi assume any liability arising out of the application or use of any product or circuit, and specifically disclaims any and all liability, including without limitation special, consequential or incidental damages. onsemi does not convey any license under its patent rights nor the rights of others.

**onsemi**, **Onsemi**, and other names, marks, and brands are registered and/or common law trademarks of Semiconductor Components Industries, LLC dba "**onsemi**" or its affiliates and/or subsidiaries in the United States and/or other countries. **onsemi** owns the rights to a number of patents, trademarks, copyrights, trade secrets, and other intellectual property. A listing of **onsemi**'s product/patent coverage may be accessed at [www.onsemi.com/site/pdf/Patent-Marking.pdf](http://www.onsemi.com/site/pdf/Patent-Marking.pdf). **onsemi** reserves the right to make changes at any time to any products or information herein, without notice. The information herein is provided "as-is" and **onsemi** makes no warranty, representation or guarantee regarding the accuracy of the information, product features, availability, functionality, or suitability of its products for any particular purpose, nor does **onsemi** assume any liability arising out of the application or use of any product or circuit, and specifically disclaims any and all liability, including without limitation special, consequential or incidental damages. Buyer is responsible for its products and applications using **onsemi** products, including compliance with all laws, regulations and safety requirements or standards, regardless of any support or applications information provided by **onsemi**. "Typical" parameters which may be provided in **onsemi** data sheets and/or specifications can and do vary in different applications and actual performance may vary over time. All operating parameters, including "Typicals" must be validated for each customer application by customer's technical experts. **onsemi** does not convey any license under any of its intellectual property rights nor the rights of others. **onsemi** products are not designed, intended, or authorized for use as a critical component in life support systems or any FDA Class 3 medical devices or medical devices with a same or similar classification in a foreign jurisdiction or any devices intended for implantation in the human body. Should Buyer purchase or use **onsemi** products for any such unintended or unauthorized application, Buyer shall indemnify and hold **onsemi** and its officers, employees, subsidiaries, affiliates, and distributors harmless against all claims, costs, damages, and expenses, and reasonable attorney fees arising out of, directly or indirectly, any claim of personal injury or death associated with such unintended or unauthorized use, even if such claim alleges that **onsemi** was negligent regarding the design or manufacture of the part. **onsemi** is an Equal Opportunity/Affirmative Action Employer. This literature is subject to all applicable copyright laws and is not for resale in any manner.

---

## ADDITIONAL INFORMATION

### TECHNICAL PUBLICATIONS:

Technical Library: [www.onsemi.com/design/resources/technical-documentation](http://www.onsemi.com/design/resources/technical-documentation)  
onsemi Website: [www.onsemi.com](http://www.onsemi.com)

### ONLINE SUPPORT: [www.onsemi.com/support](http://www.onsemi.com/support)

For additional information, please contact your local Sales Representative at [www.onsemi.com/support/sales](http://www.onsemi.com/support/sales)