

NGTG30N60FLWG

IGBT

This Insulated Gate Bipolar Transistor (IGBT) features a robust and cost effective Trench construction, and provides superior performance in demanding switching applications, offering both low on state voltage and minimal switching loss.

Features

- Low Saturation Voltage using Trench with Field Stop Technology
- Low Switching Loss Reduces System Power Dissipation
- Optimized for High Speed Switching
- 5 μ s Short-Circuit Capability
- These are Pb-Free Devices

Typical Applications

- Power Factor Correction
- Solar Inverters
- Uninterruptable Power Supply (UPS)

ABSOLUTE MAXIMUM RATINGS

| Rating | Symbol | Value | Unit |
|---|------------------|----------------------|------------------|
| Collector-emitter voltage | V_{CES} | 600 | V |
| Collector current @ $T_C = 25^\circ\text{C}$ @ $T_C = 100^\circ\text{C}$ | I_C | 60 30 | A |
| Pulsed collector current, T_{pulse} limited by $T_{J\text{max}}$ | I_{CM} | 120 | A |
| Diode Forward Current @ $T_C = 25^\circ\text{C}$ @ $T_C = 100^\circ\text{C}$ | I_F | 60 30 | A |
| Diode Pulsed Current T_{pulse} Limited by $T_{J\text{max}}$ | I_{FM} | 120 | A |
| Short-circuit withstand time $V_{GE} = 15\text{ V}$, $V_{CE} = 300\text{ V}$, $T_J \leq +150^\circ\text{C}$ | t_{SC} | 5 | μs |
| Gate-emitter voltage Transient Gate Emitter Voltage ($t_p = 5\ \mu\text{s}$, $D < 0.010$) | V_{GE} | ± 20 ± 30 | V |
| Power Dissipation @ $T_C = 25^\circ\text{C}$ @ $T_C = 100^\circ\text{C}$ | P_D | 250 67 | W |
| Operating junction temperature range | T_J | -55 to +150 | $^\circ\text{C}$ |
| Storage temperature range | T_{stg} | -55 to +150 | $^\circ\text{C}$ |
| Lead temperature for soldering, 1/8" from case for 5 seconds | T_{SLD} | 260 | $^\circ\text{C}$ |

Stresses exceeding Maximum Ratings may damage the device. Maximum Ratings are stress ratings only. Functional operation above the Recommended Operating Conditions is not implied. Extended exposure to stresses above the Recommended Operating Conditions may affect device reliability.



ON Semiconductor[®]

<http://onsemi.com>

30 A, 600 V
 $V_{CE\text{sat}} = 1.65\text{ V}$

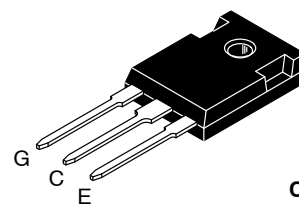
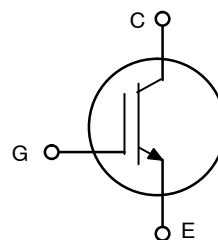

**TO-247
CASE 340L
STYLE 4**

MARKING DIAGRAM



A = Assembly Location
Y = Year
WW = Work Week
G = Pb-Free Package

ORDERING INFORMATION

| Device | Package | Shipping |
|---------------|---------------------|-----------------|
| NGTG30N60FLWG | TO-247 (Pb-Free) | 30 Units / Rail |

NGTG30N60FLWG

THERMAL CHARACTERISTICS

| Rating | Symbol | Value | Unit |
|---|-----------------|-------|-----------------------------|
| Thermal resistance junction-to-case, for IGBT | $R_{\theta JC}$ | 0.486 | $^{\circ}\text{C}/\text{W}$ |
| Thermal resistance junction-to-ambient | $R_{\theta JA}$ | 40 | $^{\circ}\text{C}/\text{W}$ |

ELECTRICAL CHARACTERISTICS ($T_J = 25^{\circ}\text{C}$ unless otherwise specified)

| Parameter | Test Conditions | Symbol | Min | Typ | Max | Unit |
|-----------|-----------------|--------|-----|-----|-----|------|
|-----------|-----------------|--------|-----|-----|-----|------|

STATIC CHARACTERISTIC

| | | | | | | |
|---|---|---------------|----------|-------------|----------|----|
| Collector-emitter breakdown voltage, gate-emitter short-circuited | $V_{GE} = 0\text{ V}, I_C = 500\ \mu\text{A}$ | $V_{(BR)CES}$ | 600 | - | - | V |
| Collector-emitter saturation voltage | $V_{GE} = 15\text{ V}, I_C = 30\text{ A}$ $V_{GE} = 15\text{ V}, I_C = 30\text{ A}, T_J = 150^{\circ}\text{C}$ | V_{CEsat} | 1.4 - | 1.65 2.0 | 1.9 - | V |
| Gate-emitter threshold voltage | $V_{GE} = V_{CE}, I_C = 200\ \mu\text{A}$ | $V_{GE(th)}$ | 4.5 | 5.5 | 6.5 | V |
| Collector-emitter cut-off current, gate-emitter short-circuited | $V_{GE} = 0\text{ V}, V_{CE} = 600\text{ V}$ $V_{GE} = 0\text{ V}, V_{CE} = 600\text{ V}, T_J = 150^{\circ}\text{C}$ | I_{CES} | - - | - - | 0.2 2 | mA |
| Gate leakage current, collector-emitter short-circuited | $V_{GE} = 20\text{ V}, V_{CE} = 0\text{ V}$ | I_{GES} | - | - | 100 | nA |

DYNAMIC CHARACTERISTIC

| | | | | | | |
|------------------------------|--|-----------|---|------|---|----|
| Input capacitance | $V_{CE} = 20\text{ V}, V_{GE} = 0\text{ V}, f = 1\text{ MHz}$ | C_{ies} | - | 4200 | - | pF |
| Output capacitance | | C_{oes} | - | 130 | - | |
| Reverse transfer capacitance | | C_{res} | - | 110 | - | |
| Gate charge total | $V_{CE} = 480\text{ V}, I_C = 30\text{ A}, V_{GE} = 15\text{ V}$ | Q_g | - | 170 | - | nC |
| Gate to emitter charge | | Q_{ge} | - | 34 | - | |
| Gate to collector charge | | Q_{gc} | - | 83 | - | |

SWITCHING CHARACTERISTIC, INDUCTIVE LOAD

| | | | | | | |
|-------------------------|--|--------------|---|------|---|----|
| Turn-on delay time | $T_J = 25^{\circ}\text{C}$ $V_{CC} = 400\text{ V}, I_C = 30\text{ A}$ $R_g = 10\ \Omega$ $V_{GE} = 0\text{ V}/15\text{ V}$ | $t_{d(on)}$ | - | 83 | - | ns |
| Rise time | | t_r | - | 31 | - | |
| Turn-off delay time | | $t_{d(off)}$ | - | 170 | - | |
| Fall time | | t_f | - | 80 | - | |
| Turn-on switching loss | | E_{on} | - | 0.7 | - | mJ |
| Turn-off switching loss | | E_{off} | - | 0.28 | - | |
| Total switching loss | | E_{ts} | - | 0.98 | - | |
| Turn-on delay time | $T_J = 150^{\circ}\text{C}$ $V_{CC} = 400\text{ V}, I_C = 30\text{ A}$ $R_g = 10\ \Omega$ $V_{GE} = 0\text{ V}/15\text{ V}$ | $t_{d(on)}$ | - | 81 | - | ns |
| Rise time | | t_r | - | 32 | - | |
| Turn-off delay time | | $t_{d(off)}$ | - | 180 | - | |
| Fall time | | t_f | - | 110 | - | |
| Turn-on switching loss | | E_{on} | - | 0.82 | - | mJ |
| Turn-off switching loss | | E_{off} | - | 0.63 | - | |
| Total switching loss | | E_{ts} | - | 1.45 | - | |

NGTG30N60FLWG

TYPICAL CHARACTERISTICS

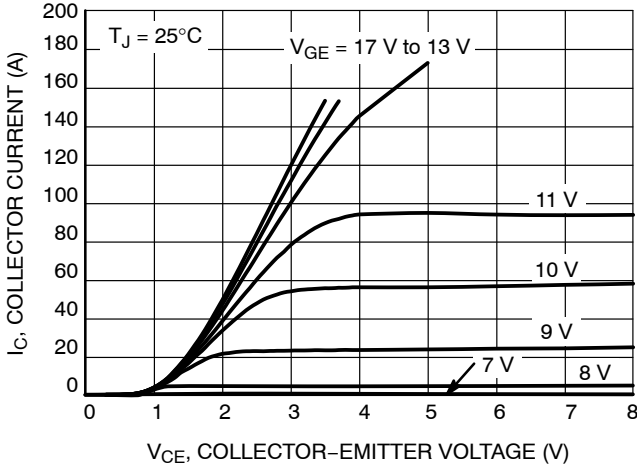

Figure 1. Output Characteristics

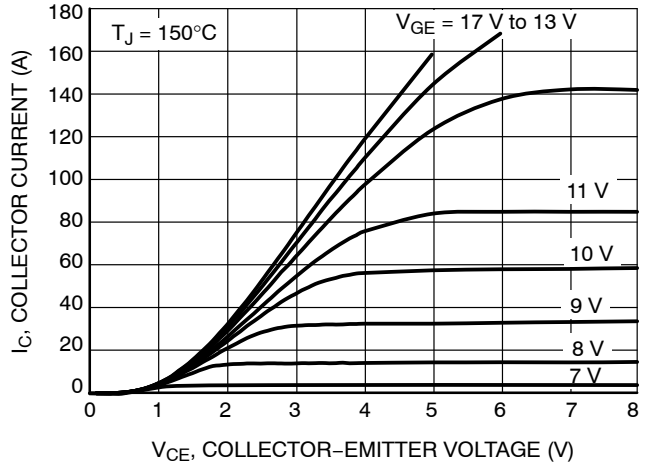

Figure 2. Output Characteristics

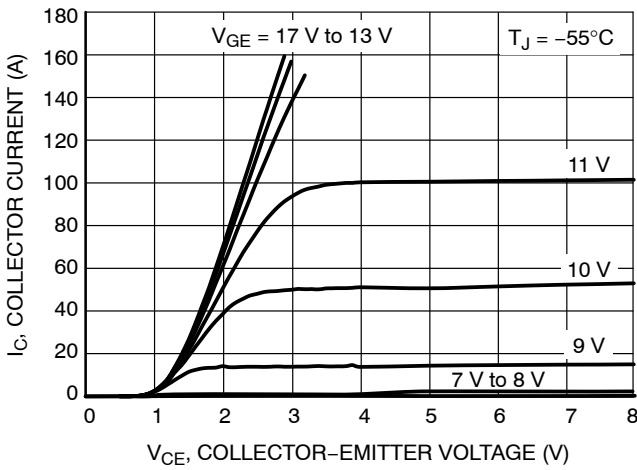

Figure 3. Output Characteristics

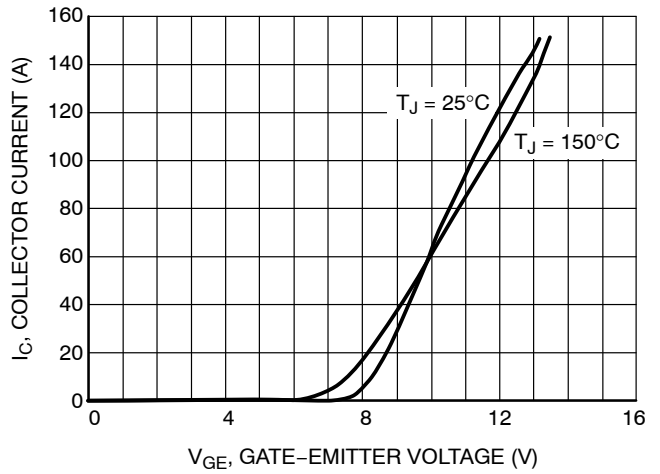

Figure 4. Typical Transfer Characteristics

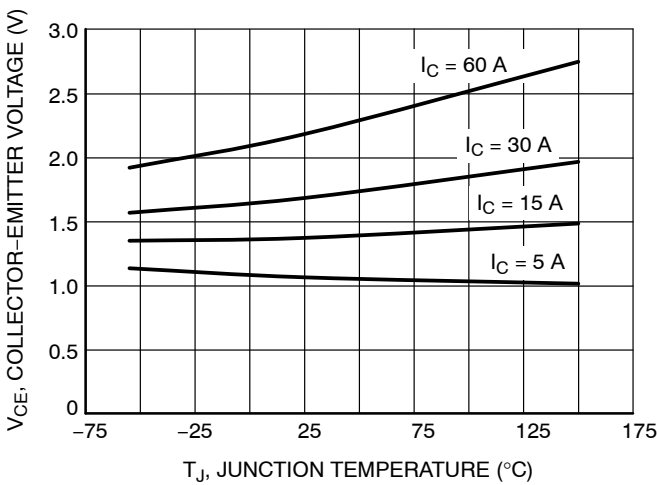

Figure 5. $V_{CE(sat)}$ vs. T_J

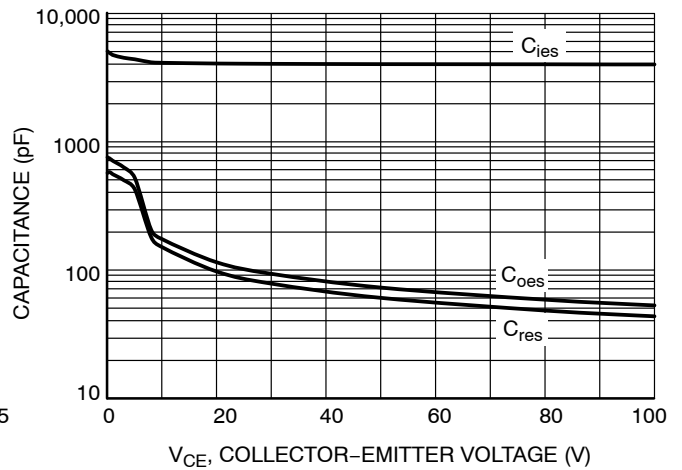

Figure 6. Typical Capacitance

NGTG30N60FLWG

TYPICAL CHARACTERISTICS

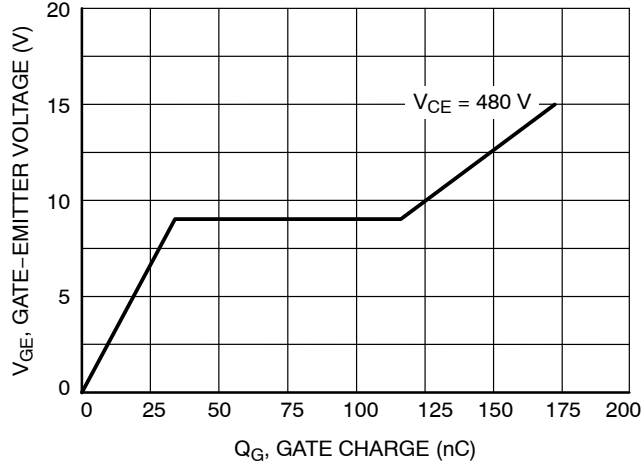

Figure 7. Typical Gate Charge

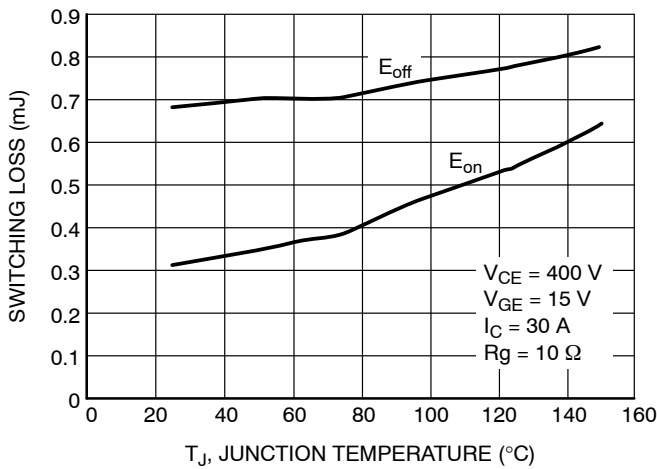

Figure 8. Switching Loss vs. Temperature

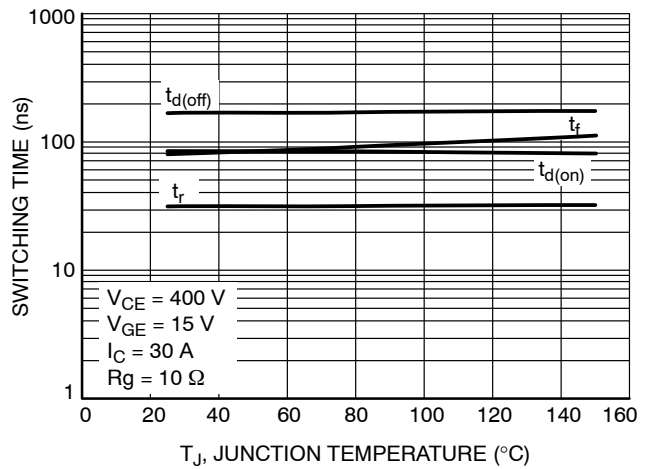

Figure 9. Switching Time vs. Temperature

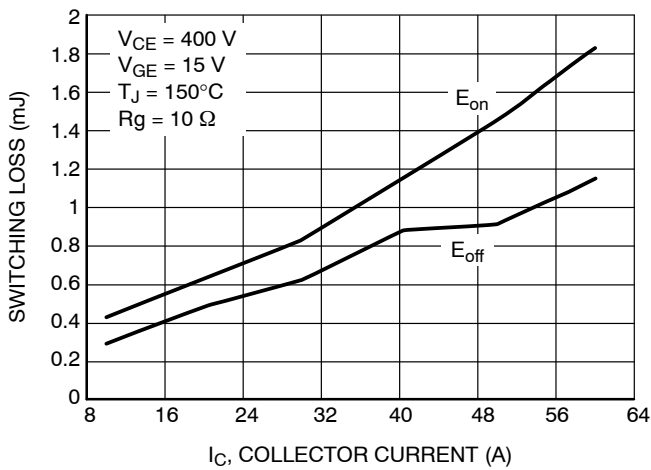

Figure 10. Switching Loss vs. I_C

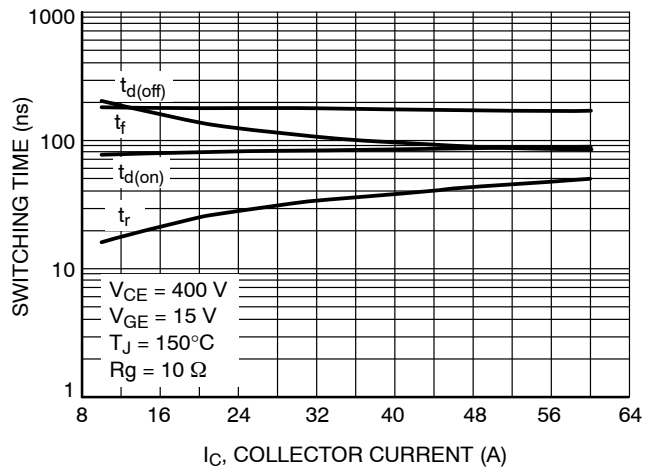

Figure 11. Switching Time vs. I_C

NGTG30N60FLWG

TYPICAL CHARACTERISTICS

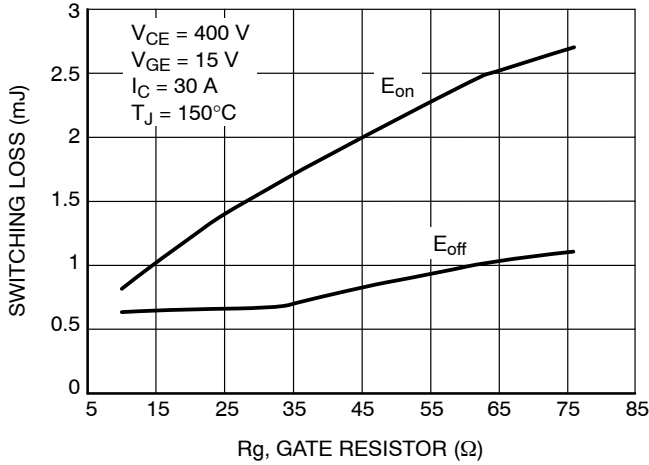

Figure 12. Switching Loss vs. Rg

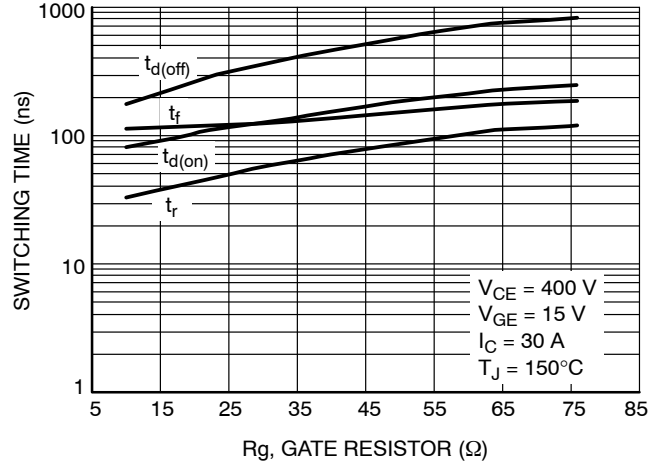

Figure 13. Switching Time vs. Rg

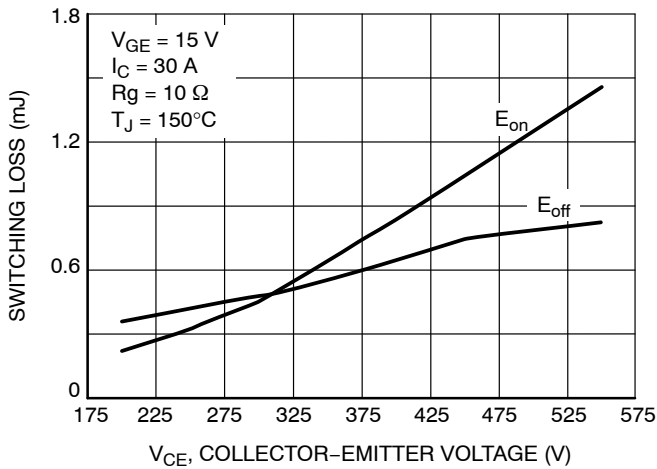

Figure 14. Switching Loss vs. VCE

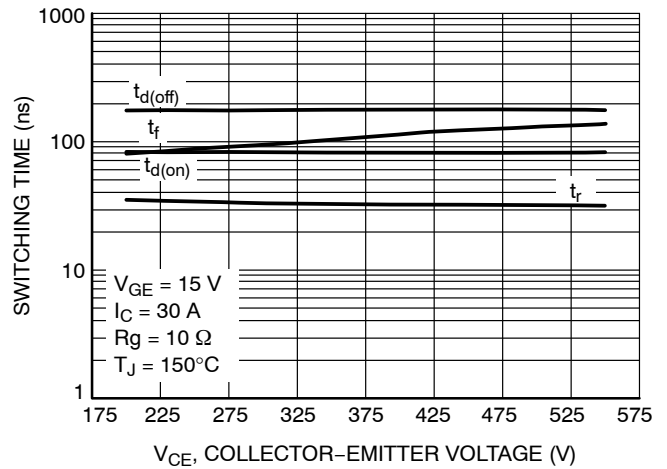

Figure 15. Switching Time vs. VCE

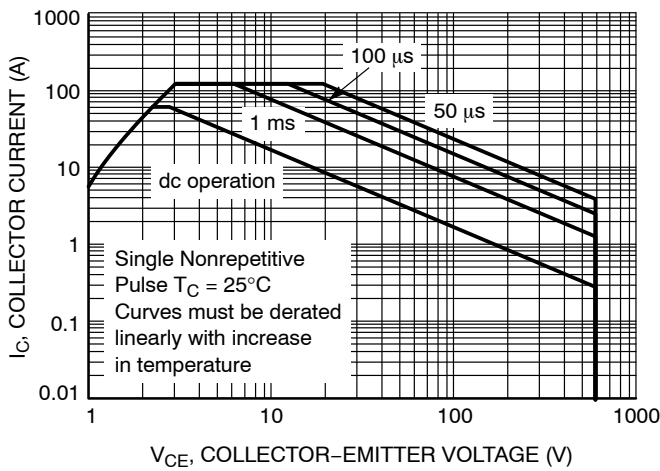

Figure 16. Safe Operating Area

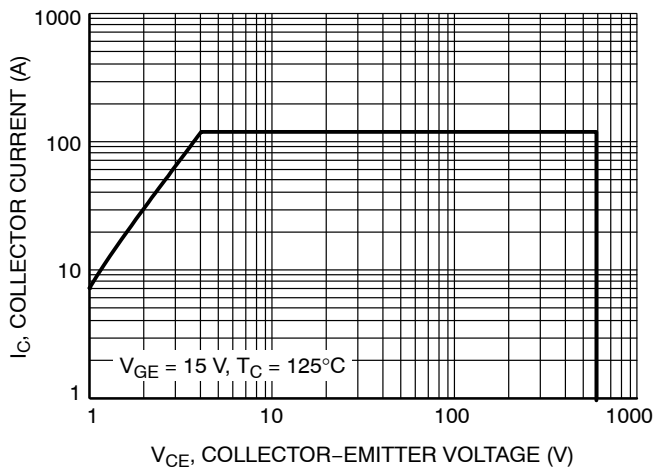

Figure 17. Reverse Bias Safe Operating Area

NGTG30N60FLWG

TYPICAL CHARACTERISTICS

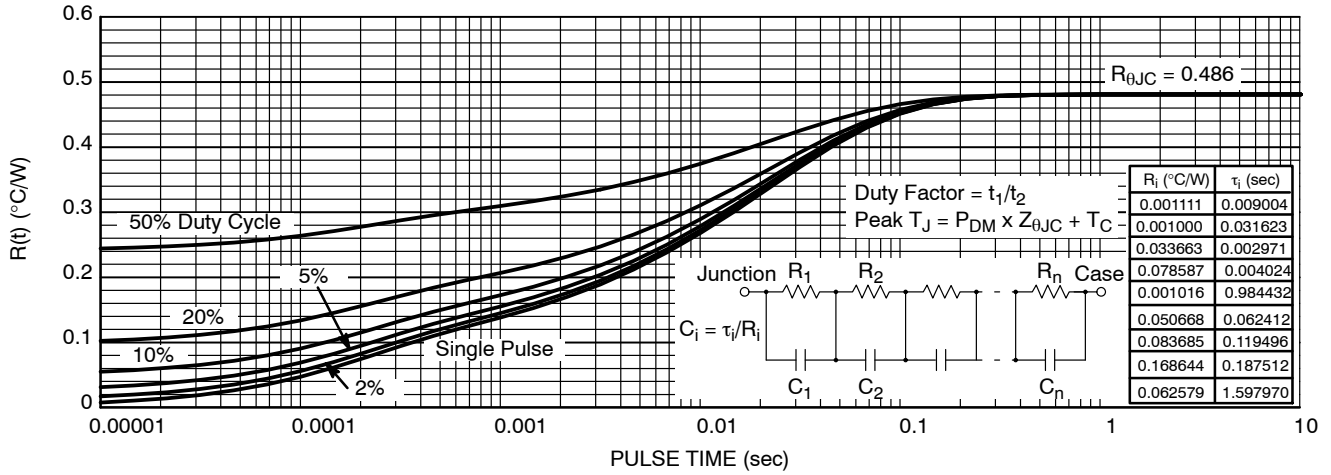

Figure 18. IGBT Transient Thermal Impedance

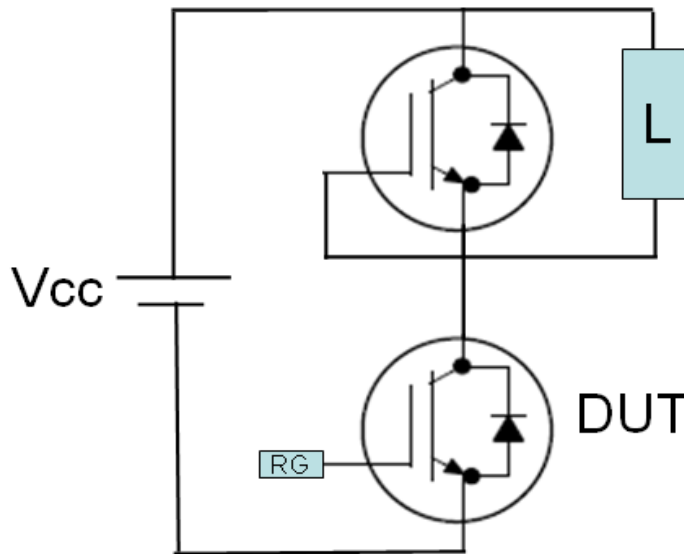

Figure 19. Test Circuit for Switching Characteristics

NGTG30N60FLWG

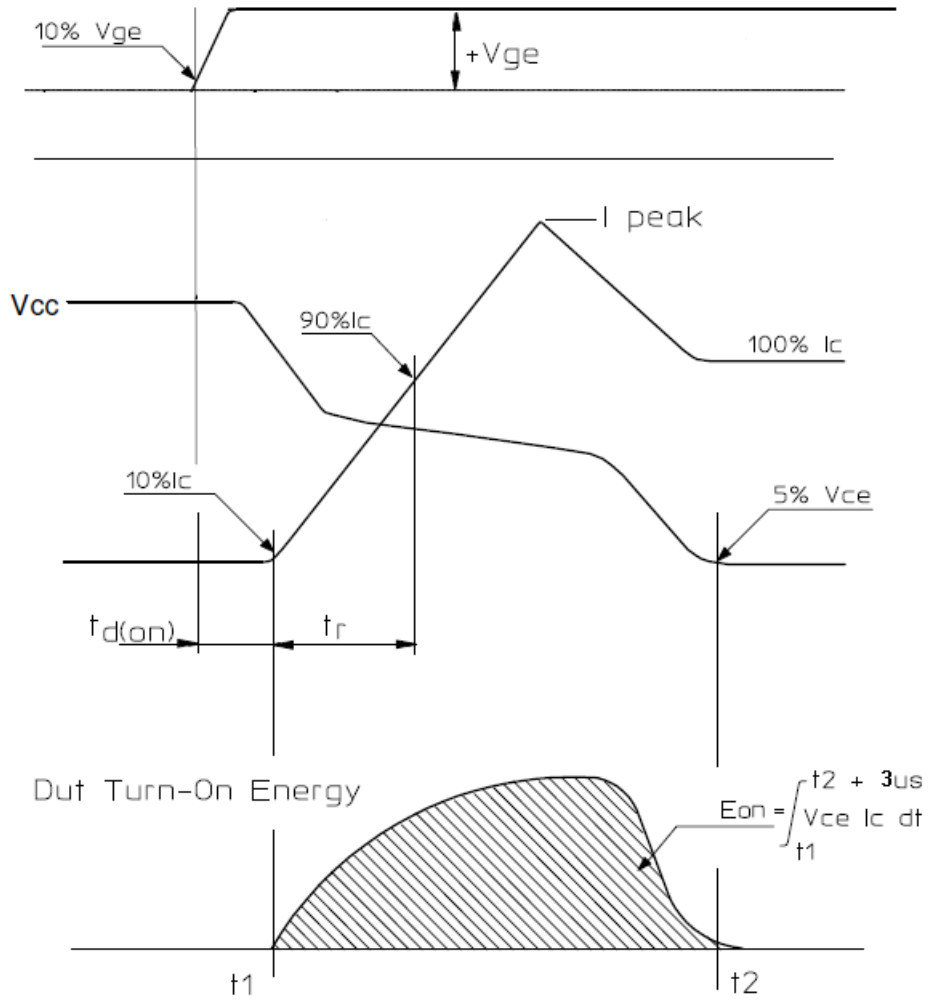

Figure 20. Definition of Turn On Waveform

NGTG30N60FLWG

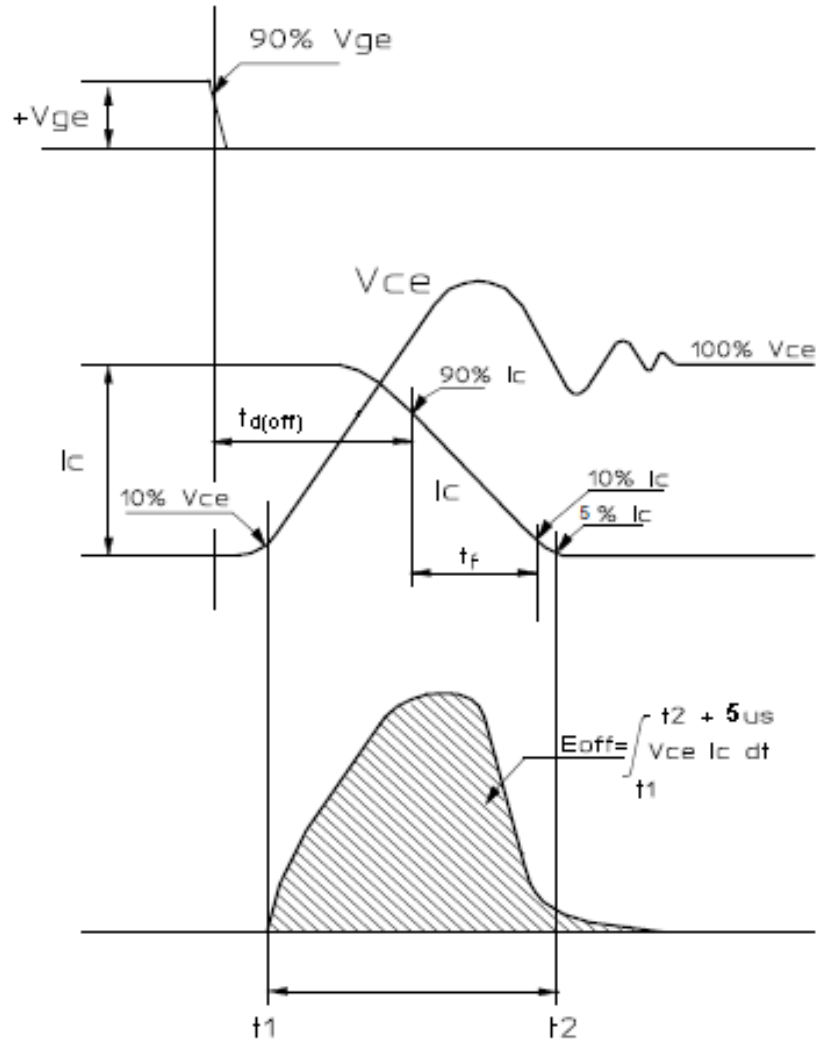
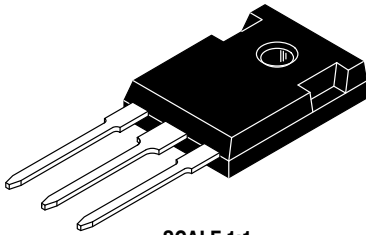

Figure 21. Definition of Turn Off Waveform

MECHANICAL CASE OUTLINE PACKAGE DIMENSIONS



TO-247
CASE 340L
ISSUE G

DATE 06 OCT 2021

SCALE 1:1



NOTES:

1. DIMENSIONING AND TOLERANCING PER ASME Y14.5M, 1982.
2. CONTROLLING DIMENSION: MILLIMETER

| DIM | MILLIMETERS | | INCHES | |
|-----|-------------|-------|-----------|-------|
| | MIN. | MAX. | MIN. | MAX. |
| A | 20.32 | 21.08 | 0.800 | 0.830 |
| B | 15.75 | 16.26 | 0.620 | 0.640 |
| C | 4.70 | 5.30 | 0.185 | 0.209 |
| D | 1.00 | 1.40 | 0.040 | 0.055 |
| E | 1.90 | 2.60 | 0.075 | 0.102 |
| F | 1.65 | 2.13 | 0.065 | 0.084 |
| G | 5.45 BSC | | 0.215 BSC | |
| H | 1.50 | 2.49 | 0.059 | 0.098 |
| J | 0.40 | 0.80 | 0.016 | 0.031 |
| K | 19.81 | 20.83 | 0.780 | 0.820 |
| L | 5.40 | 6.20 | 0.212 | 0.244 |
| N | 4.32 | 5.49 | 0.170 | 0.216 |
| P | ---- | 4.50 | ---- | 0.177 |
| Q | 3.55 | 3.65 | 0.140 | 0.144 |
| U | 6.15 BSC | | 0.242 BSC | |
| W | 2.87 | 3.12 | 0.113 | 0.123 |

GENERIC
MARKING DIAGRAM*

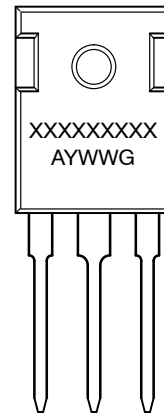

- | | | | |
|--|--|--|--|
| <p>STYLE 1: PIN 1. GATE 2. DRAIN 3. SOURCE 4. DRAIN</p> | <p>STYLE 2: PIN 1. ANODE 2. CATHODE (S) 3. ANODE 2 4. CATHODES (S)</p> | <p>STYLE 3: PIN 1. BASE 2. COLLECTOR 3. EMITTER 4. COLLECTOR</p> | <p>STYLE 4: PIN 1. GATE 2. COLLECTOR 3. EMITTER 4. COLLECTOR</p> |
| <p>STYLE 5: PIN 1. CATHODE 2. ANODE 3. GATE 4. ANODE</p> | <p>STYLE 6: PIN 1. MAIN TERMINAL 1 2. MAIN TERMINAL 2 3. GATE 4. MAIN TERMINAL 2</p> | | |

- XXXXX = Specific Device Code
A = Assembly Location
Y = Year
WW = Work Week
G = Pb-Free Package

*This information is generic. Please refer to device data sheet for actual part marking. Pb-Free indicator, "G" or microdot "▪", may or may not be present. Some products may not follow the Generic Marking.

| | | |
|------------------|-------------|--|
| DOCUMENT NUMBER: | 98ASB15080C | Electronic versions are uncontrolled except when accessed directly from the Document Repository. Printed versions are uncontrolled except when stamped "CONTROLLED COPY" in red. |
| DESCRIPTION: | TO-247 | PAGE 1 OF 1 |

onsemi and ONSEMI are trademarks of Semiconductor Components Industries, LLC dba onsemi or its subsidiaries in the United States and/or other countries. onsemi reserves the right to make changes without further notice to any products herein. onsemi makes no warranty, representation or guarantee regarding the suitability of its products for any particular purpose, nor does onsemi assume any liability arising out of the application or use of any product or circuit, and specifically disclaims any and all liability, including without limitation special, consequential or incidental damages. onsemi does not convey any license under its patent rights nor the rights of others.

onsemi, **Onsemi**, and other names, marks, and brands are registered and/or common law trademarks of Semiconductor Components Industries, LLC dba "**onsemi**" or its affiliates and/or subsidiaries in the United States and/or other countries. **onsemi** owns the rights to a number of patents, trademarks, copyrights, trade secrets, and other intellectual property. A listing of **onsemi**'s product/patent coverage may be accessed at www.onsemi.com/site/pdf/Patent-Marking.pdf. **onsemi** reserves the right to make changes at any time to any products or information herein, without notice. The information herein is provided "as-is" and **onsemi** makes no warranty, representation or guarantee regarding the accuracy of the information, product features, availability, functionality, or suitability of its products for any particular purpose, nor does **onsemi** assume any liability arising out of the application or use of any product or circuit, and specifically disclaims any and all liability, including without limitation special, consequential or incidental damages. Buyer is responsible for its products and applications using **onsemi** products, including compliance with all laws, regulations and safety requirements or standards, regardless of any support or applications information provided by **onsemi**. "Typical" parameters which may be provided in **onsemi** data sheets and/or specifications can and do vary in different applications and actual performance may vary over time. All operating parameters, including "Typicals" must be validated for each customer application by customer's technical experts. **onsemi** does not convey any license under any of its intellectual property rights nor the rights of others. **onsemi** products are not designed, intended, or authorized for use as a critical component in life support systems or any FDA Class 3 medical devices or medical devices with a same or similar classification in a foreign jurisdiction or any devices intended for implantation in the human body. Should Buyer purchase or use **onsemi** products for any such unintended or unauthorized application, Buyer shall indemnify and hold **onsemi** and its officers, employees, subsidiaries, affiliates, and distributors harmless against all claims, costs, damages, and expenses, and reasonable attorney fees arising out of, directly or indirectly, any claim of personal injury or death associated with such unintended or unauthorized use, even if such claim alleges that **onsemi** was negligent regarding the design or manufacture of the part. **onsemi** is an Equal Opportunity/Affirmative Action Employer. This literature is subject to all applicable copyright laws and is not for resale in any manner.

ADDITIONAL INFORMATION

TECHNICAL PUBLICATIONS:

Technical Library: www.onsemi.com/design/resources/technical-documentation
onsemi Website: www.onsemi.com

ONLINE SUPPORT: www.onsemi.com/support

For additional information, please contact your local Sales Representative at www.onsemi.com/support/sales