

NGTB30N135IHR1WG

IGBT with Monolithic Free Wheeling Diode

This Insulated Gate Bipolar Transistor (IGBT) features a robust and cost effective Field Stop (FS) Trench construction, provides superior performance in demanding switching applications, and offers low on-state voltage with minimal switching losses. The IGBT is well suited for resonant or soft switching applications.

Features

- Extremely Efficient Trench with Fieldstop Technology
- 1350 V Breakdown Voltage
- Optimized for Low Losses in IH Cooker Application
- Designed for High System Level Robustness
- These are Pb-Free Devices

Typical Applications

- Inductive Heating
- Consumer Appliances
- Soft Switching

ABSOLUTE MAXIMUM RATINGS

Rating	Symbol	Value	Unit
Collector-emitter voltage @ $T_J = 25^\circ\text{C}$	V_{CES}	1350	V
Collector current @ $T_C = 25^\circ\text{C}$ @ $T_C = 100^\circ\text{C}$	I_C	60 30	A
Pulsed collector current, T_{pulse} limited by T_{Jmax} 10 μs pulse, $V_{GE} = 15\text{ V}$	I_{CM}	120	A
Diode forward current @ $T_C = 25^\circ\text{C}$ @ $T_C = 100^\circ\text{C}$	I_F	60 30	A
Diode pulsed current, T_{pulse} limited by T_{Jmax} 10 μs pulse, $V_{GE} = 0\text{ V}$	I_{FM}	120	A
Gate-emitter voltage Transient Gate-emitter Voltage ($T_{pulse} = 5\ \mu\text{s}$, $D < 0.10$)	V_{GE}	± 20 ± 25	V
Power Dissipation @ $T_C = 25^\circ\text{C}$ @ $T_C = 100^\circ\text{C}$	P_D	394 197	W
Operating junction temperature range	T_J	-40 to +175	$^\circ\text{C}$
Storage temperature range	T_{stg}	-55 to +175	$^\circ\text{C}$
Lead temperature for soldering, 1/8" from case for 5 seconds	T_{SLD}	260	$^\circ\text{C}$

Stresses exceeding those listed in the Maximum Ratings table may damage the device. If any of these limits are exceeded, device functionality should not be assumed, damage may occur and reliability may be affected.



ON Semiconductor®

www.onsemi.com

30 A, 1350 V
 $V_{CEsat} = 2.4\text{ V}$
 $E_{off} = 0.63\text{ mJ}$

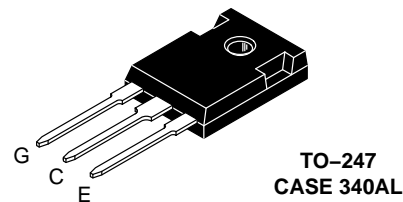
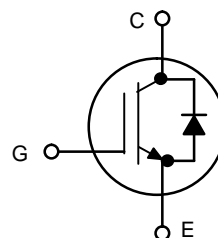

MARKING DIAGRAM



A = Assembly Location
Y = Year
WW = Work Week
G = Pb-Free Package

ORDERING INFORMATION

Device	Package	Shipping
NGTB30N135IHR1WG	TO-247 (Pb-Free)	30 Units / Rail

NGTB30N135IHR1WG

THERMAL CHARACTERISTICS

Rating	Symbol	Value	Unit
Thermal resistance junction-to-case	$R_{\theta JC}$	0.38	$^{\circ}\text{C}/\text{W}$
Thermal resistance junction-to-ambient	$R_{\theta JA}$	40	$^{\circ}\text{C}/\text{W}$

ELECTRICAL CHARACTERISTICS ($T_J = 25^{\circ}\text{C}$ unless otherwise specified)

Parameter	Test Conditions	Symbol	Min	Typ	Max	Unit
-----------	-----------------	--------	-----	-----	-----	------

STATIC CHARACTERISTIC

Collector-emitter breakdown voltage, gate-emitter short-circuited	$V_{GE} = 0\text{ V}, I_C = 5\text{ mA}$	$V_{(BR)CES}$	1350	–	–	V
Collector-emitter saturation voltage	$V_{GE} = 15\text{ V}, I_C = 30\text{ A}$ $V_{GE} = 15\text{ V}, I_C = 30\text{ A}, T_J = 175^{\circ}\text{C}$	V_{CEsat}	–	2.4 2.6	3.0 –	V
Gate-emitter threshold voltage	$V_{GE} = V_{CE}, I_C = 250\text{ }\mu\text{A}$	$V_{GE(th)}$	4.5	5.5	6.5	V
Collector-emitter cut-off current, gate-emitter short-circuited	$V_{GE} = 0\text{ V}, V_{CE} = 1350\text{ V}$ $V_{GE} = 0\text{ V}, V_{CE} = 1350\text{ V}, T_J = 175^{\circ}\text{C}$	I_{CES}	–	–	0.5 5.0	mA
Gate leakage current, collector-emitter short-circuited	$V_{GE} = 20\text{ V}, V_{CE} = 0\text{ V}$	I_{GES}	–	–	100	nA

DYNAMIC CHARACTERISTIC

Input capacitance	$V_{CE} = 20\text{ V}, V_{GE} = 0\text{ V}, f = 1\text{ MHz}$	C_{ies}	–	5530	–	pF
Output capacitance		C_{oes}	–	124	–	
Reverse transfer capacitance		C_{res}	–	100	–	
Gate charge total	$V_{CE} = 600\text{ V}, I_C = 30\text{ A}, V_{GE} = 15\text{ V}$	Q_g	–	220	–	nC
Gate to emitter charge		Q_{ge}	–	47	–	
Gate to collector charge		Q_{gc}	–	100	–	

SWITCHING CHARACTERISTIC, INDUCTIVE LOAD

Turn-off delay time	$T_J = 25^{\circ}\text{C}$ $V_{CC} = 600\text{ V}, I_C = 30\text{ A}$ $R_g = 10\text{ }\Omega$ $V_{GE} = 0\text{ V}/15\text{ V}$	$t_{d(off)}$	–	200	–	ns
Fall time		t_f	–	124	–	
Turn-off switching loss		E_{off}	–	0.63	–	
Turn-off delay time	$T_J = 150^{\circ}\text{C}$ $V_{CC} = 600\text{ V}, I_C = 30\text{ A}$ $R_g = 10\text{ }\Omega$ $V_{GE} = 0\text{ V}/15\text{ V}$	$t_{d(off)}$	–	222	–	ns
Fall time		t_f	–	221	–	
Turn-off switching loss		E_{off}	–	1.50	–	

DIODE CHARACTERISTIC

Forward voltage	$V_{GE} = 0\text{ V}, I_F = 30\text{ A}$ $V_{GE} = 0\text{ V}, I_F = 30\text{ A}, T_J = 175^{\circ}\text{C}$	V_F	–	1.7 2.1	2.2 –	V
-----------------	---	-------	---	------------	----------	---

NGTB30N135IHR1WG

TYPICAL CHARACTERISTICS

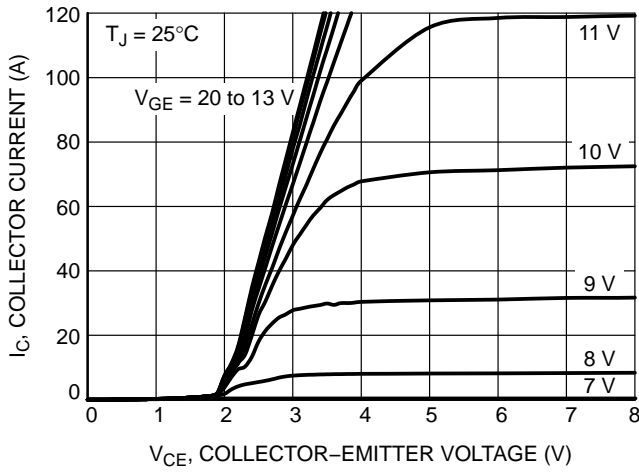

Figure 1. Output Characteristics

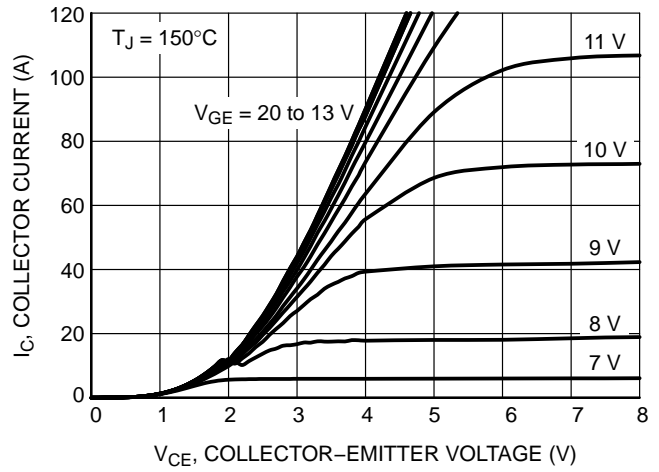

Figure 2. Output Characteristics

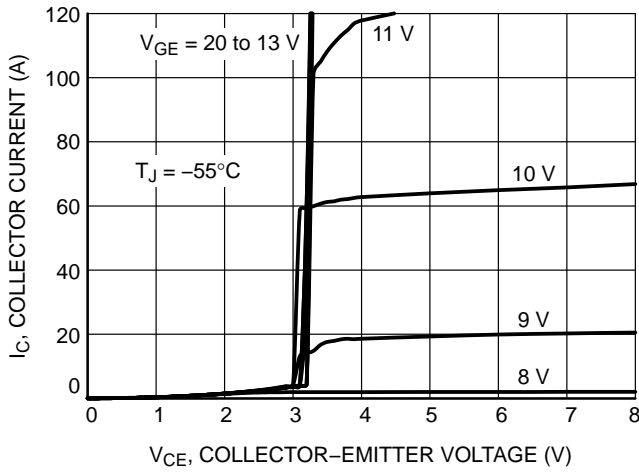

Figure 3. Output Characteristics

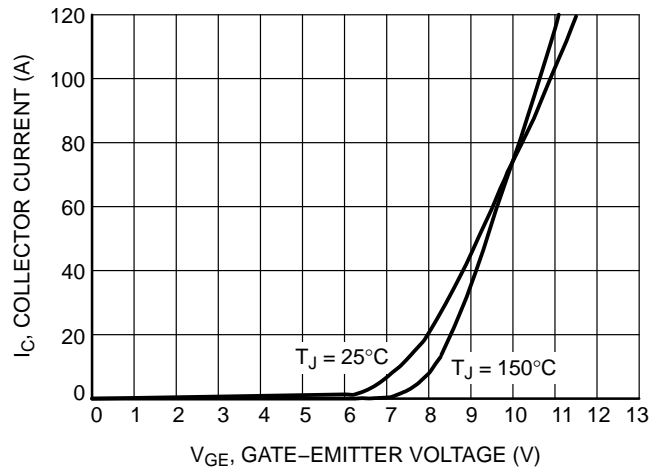

Figure 4. Typical Transfer Characteristics

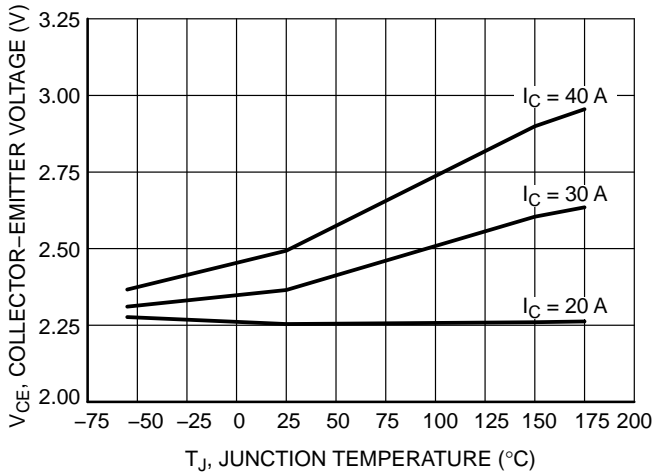

Figure 5. $V_{CE(sat)}$ vs. T_J

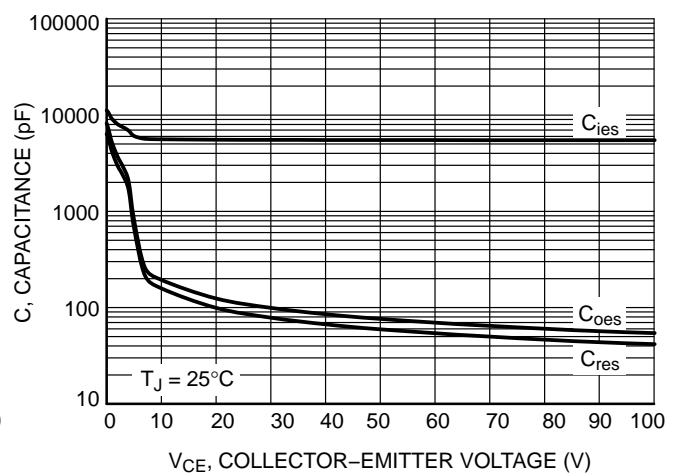

Figure 6. Typical Capacitance

NGTB30N135IHR1WG

TYPICAL CHARACTERISTICS

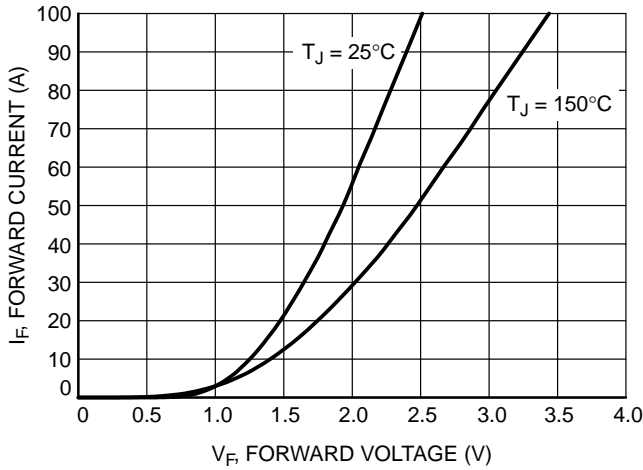

Figure 7. Diode Forward Characteristics

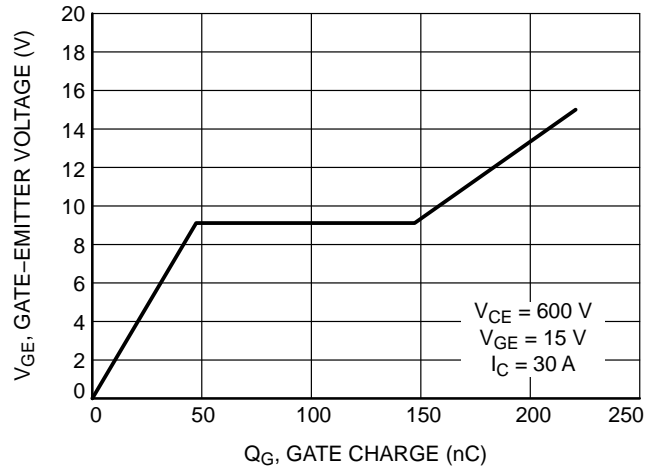

Figure 8. Typical Gate Charge

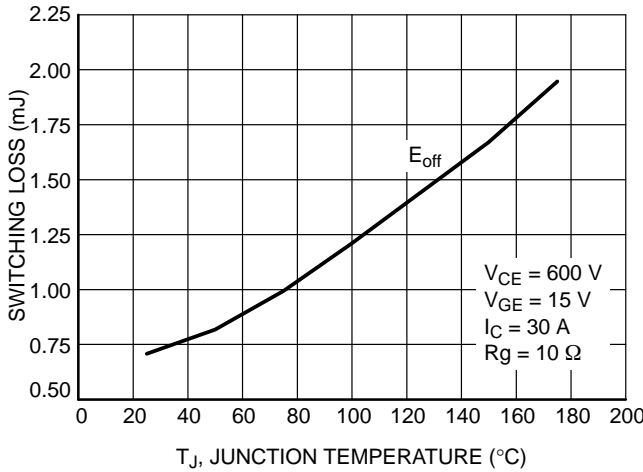

Figure 9. Switching Loss vs. Temperature

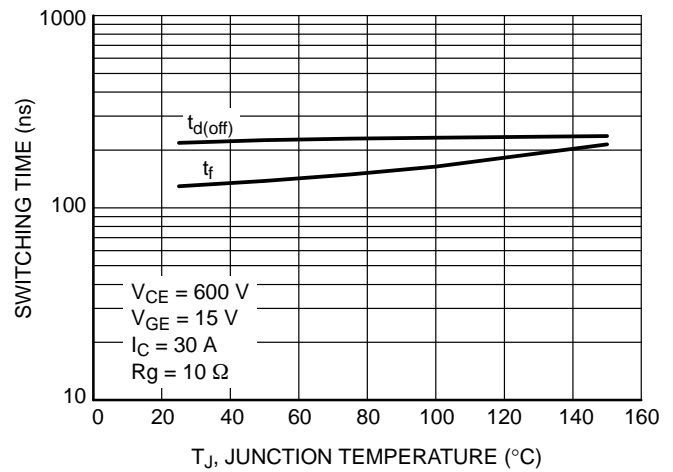

Figure 10. Switching Time vs. Temperature

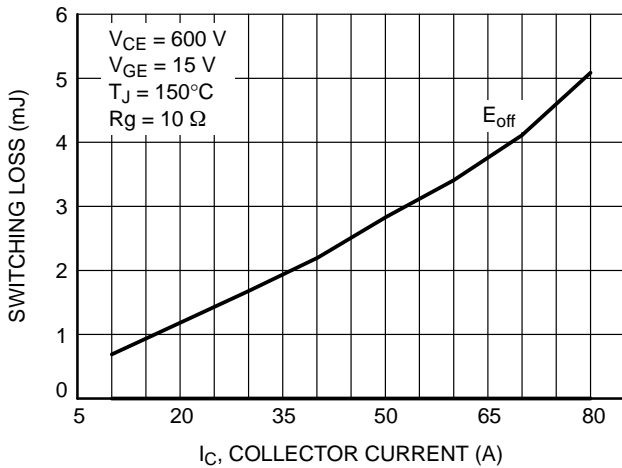

Figure 11. Switching Loss vs. I_C

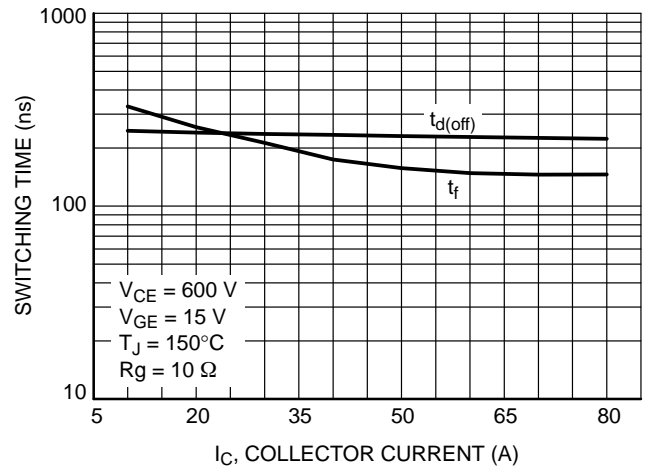

Figure 12. Switching Time vs. I_C

NGTB30N135IHR1WG

TYPICAL CHARACTERISTICS

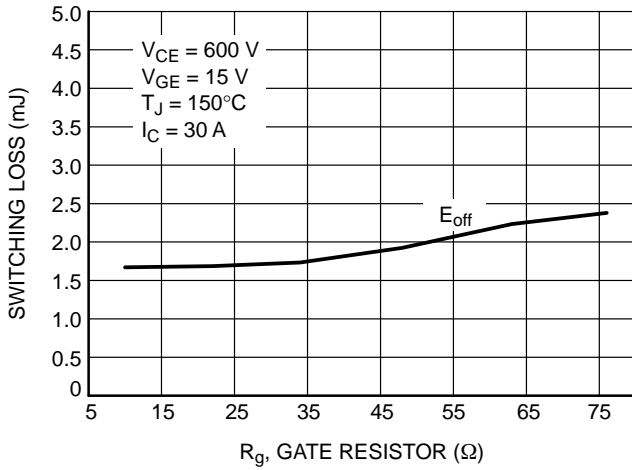

Figure 13. Switching Loss vs. R_g

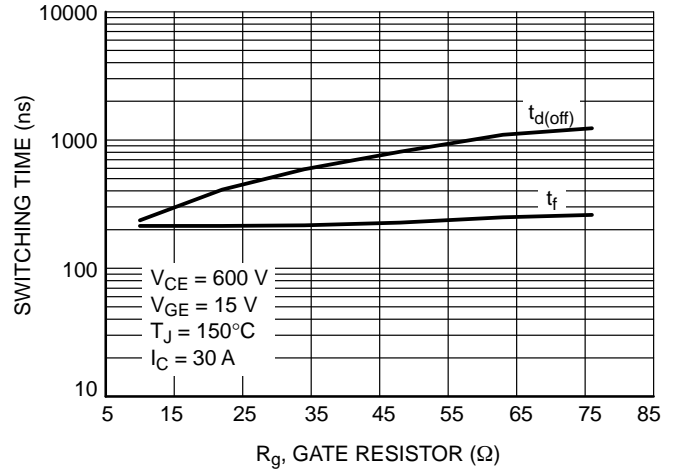

Figure 14. Switching Time vs. R_g

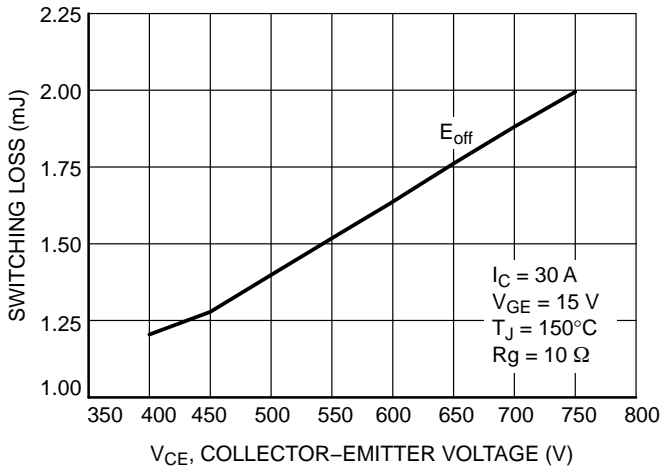

Figure 15. Switching Loss vs. V_{CE}

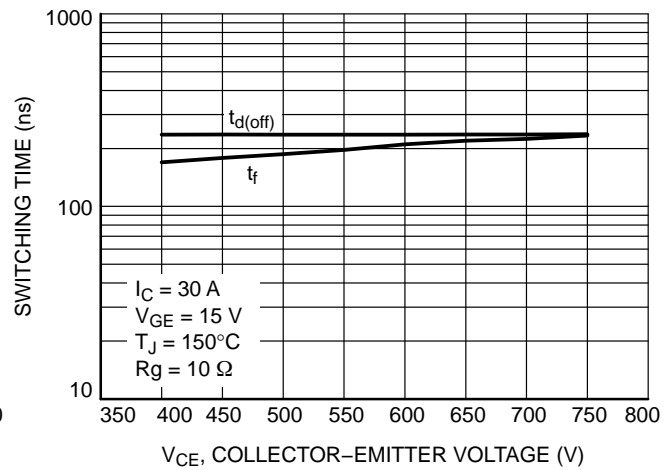

Figure 16. Switching Time vs. V_{CE}

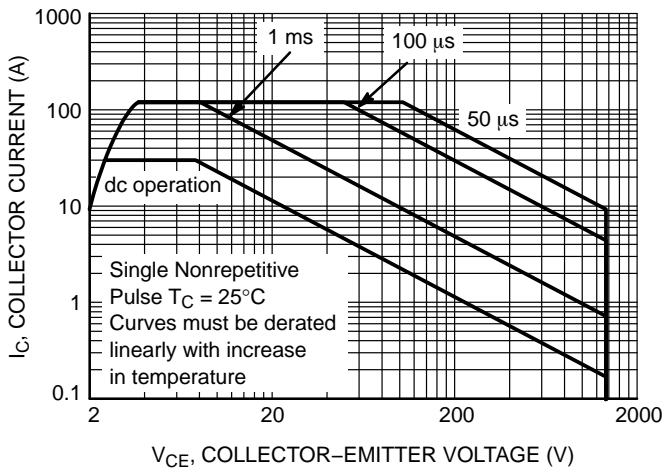

Figure 17. Safe Operating Area

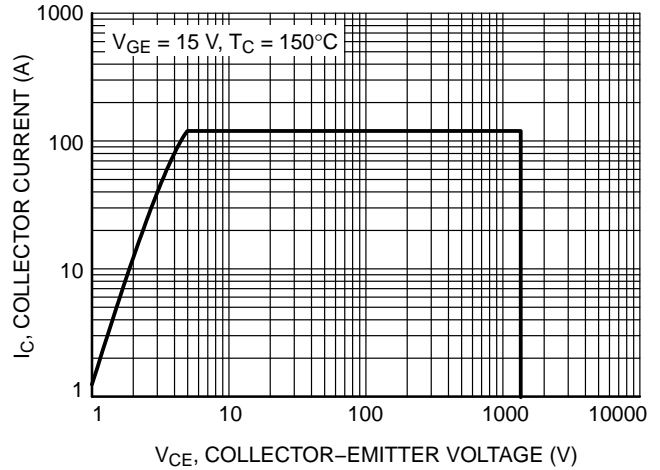

Figure 18. Reverse Bias Safe Operating Area

NGTB30N135IHR1WG

TYPICAL CHARACTERISTICS

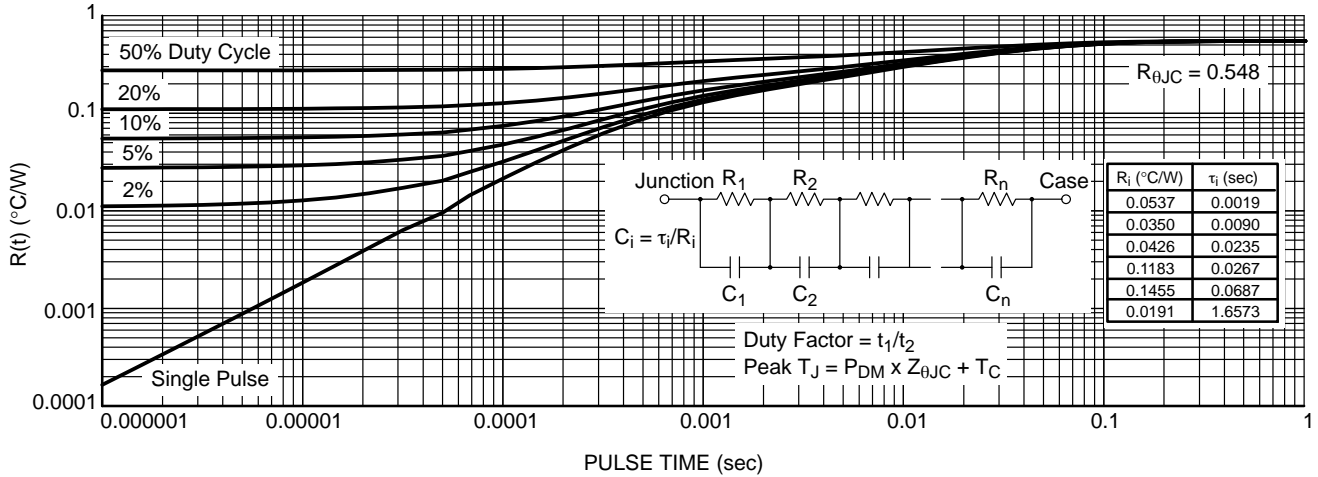

Figure 19. IGBT Transient Thermal Impedance

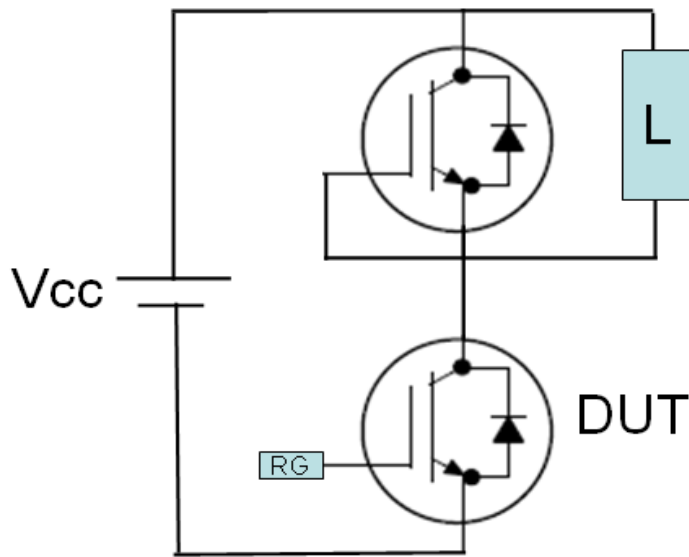

Figure 20. Test Circuit for Switching Characteristics

NGTB30N135IHR1WG

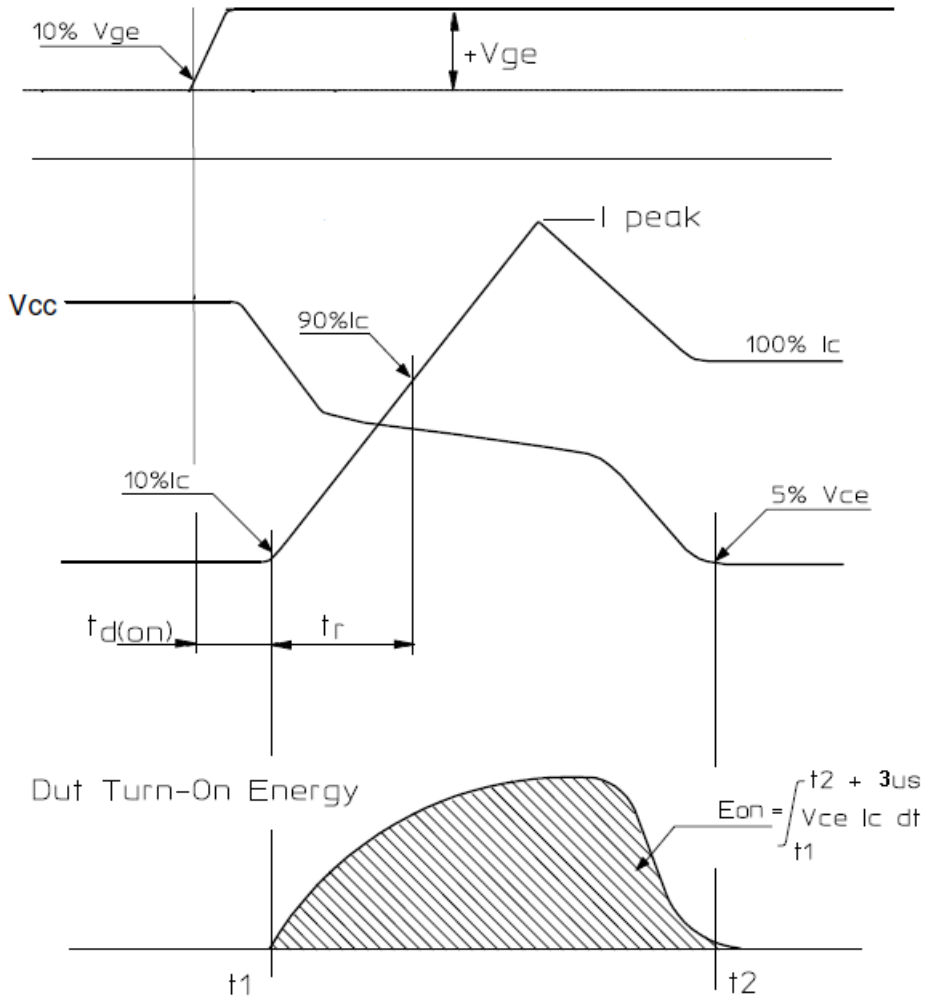

Figure 21. Definition of Turn On Waveform

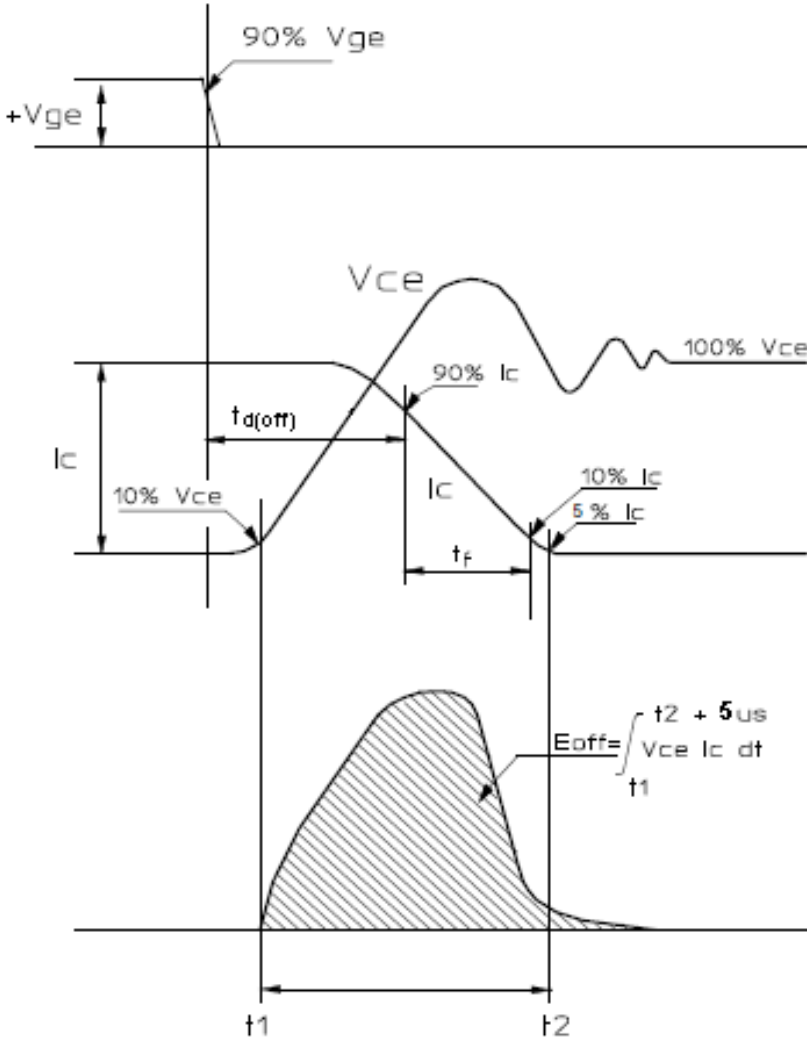

Figure 22. Definition of Turn Off Waveform

MECHANICAL CASE OUTLINE PACKAGE DIMENSIONS

ON Semiconductor®



TO-247
CASE 340AL
ISSUE D

DATE 17 MAR 2017

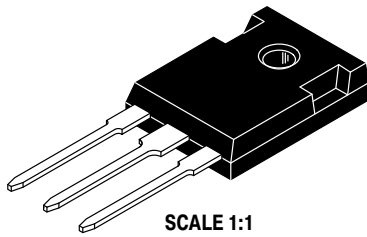

SCALE 1:1

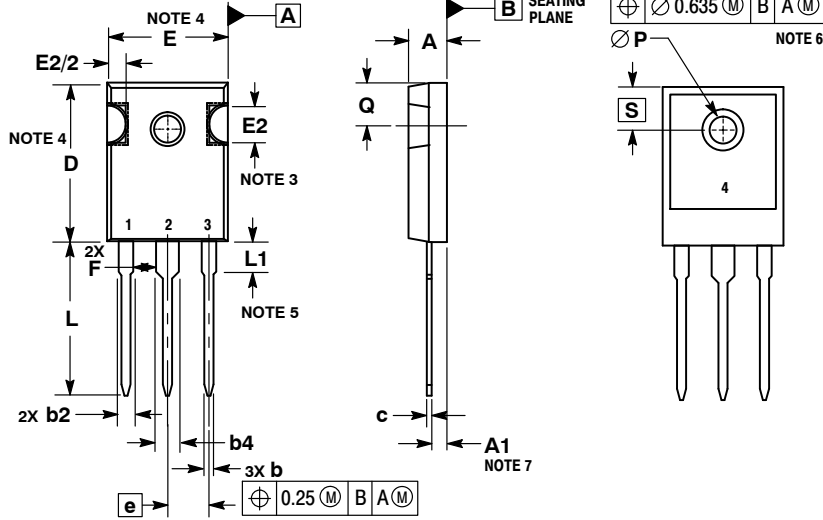

NOTES:

1. DIMENSIONING AND TOLERANCING PER ASME Y14.5M, 1994.
2. CONTROLLING DIMENSION: MILLIMETERS.
3. SLOT REQUIRED, NOTCH MAY BE ROUNDED.
4. DIMENSIONS D AND E DO NOT INCLUDE MOLD FLASH. MOLD FLASH SHALL NOT EXCEED 0.13 PER SIDE. THESE DIMENSIONS ARE MEASURED AT THE OUTERMOST EXTREME OF THE PLASTIC BODY.
5. LEAD FINISH IS UNCONTROLLED IN THE REGION DEFINED BY L1.
6. ØP SHALL HAVE A MAXIMUM DRAFT ANGLE OF 1.5° TO THE TOP OF THE PART WITH A MAXIMUM DIAMETER OF 3.91.
7. DIMENSION A1 TO BE MEASURED IN THE REGION DEFINED BY L1.

MILLIMETERS		
DIM	MIN	MAX
A	4.70	5.30
A1	2.20	2.60
b	1.07	1.33
b2	1.65	2.35
b4	2.60	3.40
c	0.45	0.68
D	20.80	21.34
E	15.50	16.25
E2	4.32	5.49
e	5.45 BSC	
F	2.655	---
L	19.80	20.80
L1	3.81	4.32
P	3.55	3.65
Q	5.40	6.20
S	6.15 BSC	

GENERIC MARKING DIAGRAM*

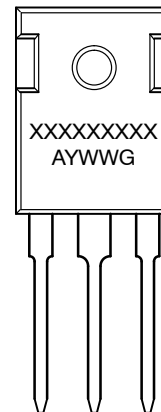

- XXXXXX = Specific Device Code
- A = Assembly Location
- Y = Year
- WW = Work Week
- G = Pb-Free Package

*This information is generic. Please refer to device data sheet for actual part marking.
Pb-Free indicator, "G" or microdot "▪", may or may not be present.

DOCUMENT NUMBER:	98AON16119F	Electronic versions are uncontrolled except when accessed directly from the Document Repository. Printed versions are uncontrolled except when stamped "CONTROLLED COPY" in red.
DESCRIPTION:	TO-247	PAGE 1 OF 1

ON Semiconductor and are trademarks of Semiconductor Components Industries, LLC dba ON Semiconductor or its subsidiaries in the United States and/or other countries. ON Semiconductor reserves the right to make changes without further notice to any products herein. ON Semiconductor makes no warranty, representation or guarantee regarding the suitability of its products for any particular purpose, nor does ON Semiconductor assume any liability arising out of the application or use of any product or circuit, and specifically disclaims any and all liability, including without limitation special, consequential or incidental damages. ON Semiconductor does not convey any license under its patent rights nor the rights of others.

onsemi, **Onsemi**, and other names, marks, and brands are registered and/or common law trademarks of Semiconductor Components Industries, LLC dba "**onsemi**" or its affiliates and/or subsidiaries in the United States and/or other countries. **onsemi** owns the rights to a number of patents, trademarks, copyrights, trade secrets, and other intellectual property. A listing of **onsemi**'s product/patent coverage may be accessed at www.onsemi.com/site/pdf/Patent-Marking.pdf. **onsemi** reserves the right to make changes at any time to any products or information herein, without notice. The information herein is provided "as-is" and **onsemi** makes no warranty, representation or guarantee regarding the accuracy of the information, product features, availability, functionality, or suitability of its products for any particular purpose, nor does **onsemi** assume any liability arising out of the application or use of any product or circuit, and specifically disclaims any and all liability, including without limitation special, consequential or incidental damages. Buyer is responsible for its products and applications using **onsemi** products, including compliance with all laws, regulations and safety requirements or standards, regardless of any support or applications information provided by **onsemi**. "Typical" parameters which may be provided in **onsemi** data sheets and/or specifications can and do vary in different applications and actual performance may vary over time. All operating parameters, including "Typicals" must be validated for each customer application by customer's technical experts. **onsemi** does not convey any license under any of its intellectual property rights nor the rights of others. **onsemi** products are not designed, intended, or authorized for use as a critical component in life support systems or any FDA Class 3 medical devices or medical devices with a same or similar classification in a foreign jurisdiction or any devices intended for implantation in the human body. Should Buyer purchase or use **onsemi** products for any such unintended or unauthorized application, Buyer shall indemnify and hold **onsemi** and its officers, employees, subsidiaries, affiliates, and distributors harmless against all claims, costs, damages, and expenses, and reasonable attorney fees arising out of, directly or indirectly, any claim of personal injury or death associated with such unintended or unauthorized use, even if such claim alleges that **onsemi** was negligent regarding the design or manufacture of the part. **onsemi** is an Equal Opportunity/Affirmative Action Employer. This literature is subject to all applicable copyright laws and is not for resale in any manner.

ADDITIONAL INFORMATION

TECHNICAL PUBLICATIONS:

Technical Library: www.onsemi.com/design/resources/technical-documentation
onsemi Website: www.onsemi.com

ONLINE SUPPORT: www.onsemi.com/support

For additional information, please contact your local Sales Representative at www.onsemi.com/support/sales

