

Operational Amplifier, Low Power, Rail-to-Rail

NCV952

The NCV952 is a dual, low power, operational amplifier fully specified for 3 V, 5 V and 24 V operation. Rail-to-rail output performance over the supply range of 2.7 V to 26 V provides increased dynamic range in single-supply and split-supply applications. This device offers a gain-bandwidth of 3.5 MHz and a slew rate of 1 V/ μ s, with only 0.7 mA of quiescent current. The NCV952 is available in a space saving 8-pin TSSOP8 package.

Features

- Rail-to-rail Input Common Mode Voltage Range
- Rail-to-rail Output Swing
- Wide Supply Range: 2.7 V to 26 V
- Excellent Gain-bandwidth and Speed: 3.5 MHz at 1 V/ μ s with 3 V Supply
- Low Quiescent Current: 0.7 mA at $V_S = 3$ V per Channel
- PSRR: 105 dB Typical
- NCV Prefix for Automotive and Other Applications Requiring Unique Site and Control Change Requirements; AEC-Q100 Qualified and PPAP Capable
- These Devices are Pb-free, Halogen Free/BFR Free and are RoHS Compliant

Typical Applications

- General Purpose Operational Amplifier
- Active Filters
- Signal Conditioning Amplifiers/ADC Buffers
- Set-top Boxes
- Laptop/Notebook Computers
- Transformer/Line Drivers
- Personal Entertainment Systems
- Cell Phones and Other Portable Communications
- Portable Headphone Speaker Drivers
- Instrumentation and Sensoring



TSSOP-8
CASE 948S

MARKING DIAGRAM

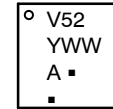

- V52 = Specific Device Code
- A = Assembly Location
- Y = Year
- WW = Work Week
- = Pb-Free Package

PIN CONNECTIONS

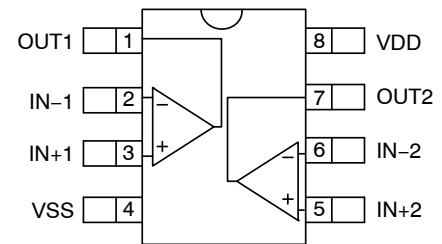

ORDERING INFORMATION

Device	Package	Shipping†
NCV952DTBR2G	TSSOP-8 (Pb-Free)	2500 / Tape & Reel

†For information on tape and reel specifications, including part orientation and tape sizes, please refer to our Tape and Reel Packaging Specification Brochure, BRD8011/D.

NCV952

Table 1. PIN DESCRIPTION

Pin	Name	Type	Description
1	OUT1	Output	Output of opamp 1
2	IN-1	Input	Inverting input of opamp 1
3	IN+1	Input	Non-inverting input of opamp 1
4	VSS	Power	Negative supply. A bypass capacitor of 0.1 μ F to ground is recommended as close as possible to this pin.
5	IN+2	Input	Non-inverting input of opamp 2
6	IN-2	Input	Inverting input of opamp 2
7	OUT2	Output	Output of opamp 2
8	VDD	Power	Positive supply. A bypass capacitor of 0.1 μ F to ground is recommended as close as possible to this pin.

Table 2. ABSOLUTE MAXIMUM RATINGS (Over operating free-air temperature, unless otherwise stated)

Parameter	Symbol	Limit	Unit
Supply Voltage ($V_{DD} - V_{SS}$)	V_S	28	V

INPUT AND OUTPUT PINS

Input Voltage	V_{IN}	$V_{SS} - 0.3$ to $V_{DD} + 0.3$	V
Differential Input Voltage (Note 1)	V_{ID}	± 1	V

TEMPERATURE

Storage Temperature	T_{STG}	-65 to +150	$^{\circ}$ C
Junction Temperature	T_J	+150	$^{\circ}$ C

ESD RATINGS (Note 2)

Human Body Model	HBM	2500	V
Machine Model	MM	300	V

Stresses exceeding those listed in the Maximum Ratings table may damage the device. If any of these limits are exceeded, device functionality should not be assumed, damage may occur and reliability may be affected.

- Input differential voltage is the non-inverting pin with respect to the inverting pin. If $V_{ID} > \pm 1$ V, the maximum input current must not exceed ± 1 mA; an input series resistor must be used to limit the input current.
- This device series incorporates ESD protection and is tested by the following methods:
 ESD Human Body Model tested per AEC-Q100-002 (JEDEC standard: JESD22-A114)
 ESD Machine Model tested per AEC-Q100-003 (JEDEC standard: JESD22-A115)

Table 3. THERMAL INFORMATION (Note 3)

Parameter	Symbol	Value	Unit
Junction to Ambient (Note 4)	θ_{JA}	140	$^{\circ}$ C/W
Junction to Case Top (Note 4)	ψ_{JT}	34	$^{\circ}$ C/W

- Short-circuits can cause excessive heating and destructive dissipation. Values are typical.
- Multilayer board, 1 oz. copper, 400 mm² copper area, both junctions heated equally.

Table 4. RECOMMENDED OPERATING CONDITIONS

Parameter	Symbol	Limit	Unit
Operating Supply Voltage	V_S	2.7 to 26	V
Specified Operating Range	T_A	-40 to +125	$^{\circ}$ C

Functional operation above the stresses listed in the Recommended Operating Ranges is not implied. Extended exposure to stresses beyond the Recommended Operating Ranges limits may affect device reliability.

NCV952

Table 5. ELECTRICAL CHARACTERISTICS AT $V_S = 3.0\text{ V}$

At $T_A = +25^\circ\text{C}$, $R_L = 10\text{ k}\Omega$ connected to mid-supply, $V_{CM} = V_{OUT} = \text{mid-supply}$, unless otherwise noted.

Boldface limits apply over the specified temperature range, $T_A = -40^\circ\text{C}$ to $+125^\circ\text{C}$, guaranteed by characterization and/or design.

Parameter	Symbol	Conditions	Min	Typ	Max	Unit
INPUT CHARACTERISTICS						
Offset Voltage	V_{OS}			0.6	6.0	mV
					8.0	mV
Offset Voltage Drift	$\Delta V/\Delta T$			2.0		$\mu\text{V}/^\circ\text{C}$
Input Bias Current	I_{IB}			55	100	nA
					200	nA
Input Offset Current	I_{OS}			1.0	30	nA
					80	nA
Input Common Mode Range	V_{CM}		$V_{SS} - 0.2$		$V_{DD} + 0.2$	V
Common Mode Rejection Ratio	CMRR	$V_{SS} + 0.15 < V_{CM} < V_{DD} - 0.15$	50	80		dB

OUTPUT CHARACTERISTICS

Output Voltage High	V_{OH}	$R_L = 600\ \Omega$	$V_{DD} - 0.2$	$V_{DD} - 0.08$		V
Output Voltage Low	V_{OL}	$R_L = 600\ \Omega$		$V_{SS} + 0.10$	$V_{SS} + 0.25$	V
Short Circuit Current	I_{SC}		10			mA

NOISE PERFORMANCE

Voltage Noise Density	e_N	$f = 1\text{ kHz}$, no load		25		nV/ $\sqrt{\text{Hz}}$
-----------------------	-------	------------------------------	--	----	--	------------------------

DYNAMIC PERFORMANCE

Open Loop Voltage Gain	A_{VOL}	$V_O = 2\text{ Vpp}$, $R_L = 600\ \Omega$		88		dB
Gain Bandwidth Product	GBWP	$R_L = 2\text{ k}\Omega$		3.5		MHz
Gain Margin	A_M	$R_L = 600\ \Omega$, $C_L = 100\text{ pF}$		8		dB
Phase Margin	ψ_M	$R_L = 600\ \Omega$, $C_L = 100\text{ pF}$		56		$^\circ$
Slew Rate	SR	$R_L = 10\text{ k}\Omega$		1.0		V/ μs
Total Harmonic Distortion + Noise	THD+N	$V_{OUT} = 2\text{ Vpp}$, $f_{IN} = 10\text{ kHz}$, $A_V = 2$, $R_L = 10\text{ k}\Omega$		0.008		%

POWER SUPPLY

Power Supply Rejection Ratio	PSRR	$V_S = 2.7\text{ V}$ to 26 V	60	105		dB
Quiescent Current	I_{DD}	No load, $V_{CM} = V_S/2$, per channel		0.7	1.3	mA

Product parametric performance is indicated in the Electrical Characteristics for the listed test conditions, unless otherwise noted. Product performance may not be indicated by the Electrical Characteristics if operated under different conditions.

NCV952

Table 6. ELECTRICAL CHARACTERISTICS AT $V_S = 5.0\text{ V}$

At $T_A = +25^\circ\text{C}$, $R_L = 10\text{ k}\Omega$ connected to mid-supply, $V_{CM} = V_{OUT} = \text{mid-supply}$, unless otherwise noted.

Boldface limits apply over the specified temperature range, $T_A = -40^\circ\text{C}$ to $+125^\circ\text{C}$, guaranteed by characterization and/or design.

Parameter	Symbol	Conditions	Min	Typ	Max	Unit
INPUT CHARACTERISTICS						
Offset Voltage	V_{OS}			0.6	6.0	mV
					8.0	mV
Offset Voltage Drift	$\Delta V/\Delta T$			2.0		$\mu\text{V}/^\circ\text{C}$
Input Bias Current	I_{IB}			55	100	nA
					200	nA
Input Offset Current	I_{OS}			1.0	30	nA
					80	nA
Input Common Mode Range	V_{CM}		$V_{SS} - 0.2$		$V_{DD} + 0.2$	V
Common Mode Rejection Ratio	CMRR	$V_{SS} + 0.15 < V_{CM} < V_{DD} - 0.15$	50	85		dB
OUTPUT CHARACTERISTICS						
Output Voltage High	V_{OH}	$R_L = 600\ \Omega$	$V_{DD} - 0.30$	$V_{DD} - 0.10$		V
Output Voltage Low	V_{OL}	$R_L = 600\ \Omega$		$V_{SS} + 0.14$	$V_{SS} + 0.30$	V
Short Circuit Current	I_{SC}		10			mA
NOISE PERFORMANCE						
Voltage Noise Density	e_N	$f = 1\text{ kHz, no load}$		25		nV/ $\sqrt{\text{Hz}}$
DYNAMIC PERFORMANCE						
Open Loop Voltage Gain	A_{VOL}	$V_O = 2\text{ Vpp, } R_L = 600\ \Omega$		88		dB
Gain Bandwidth Product	GBWP	$R_L = 2\text{ k}\Omega$		3.6		MHz
Gain Margin	A_M	$R_L = 600\ \Omega, C_L = 100\text{ pF}$		9		dB
Phase Margin	ψ_M	$R_L = 600\ \Omega, C_L = 100\text{ pF}$		60		$^\circ$
Slew Rate	SR	$R_L = 10\text{ k}\Omega$		1.0		V/ μs
Total Harmonic Distortion + Noise	THD+N	$V_{OUT} = 4\text{ Vpp, } f_{IN} = 10\text{ kHz, } A_V = 2, R_L = 10\text{ k}\Omega$		0.008		%
POWER SUPPLY						
Power Supply Rejection Ratio	PSRR	$V_S = 2.7\text{ V to } 26\text{ V}$	60	105		dB
Quiescent Current	I_{CC}	No load, $V_{CM} = V_S/2$, per channel		0.75	1.4	mA

Product parametric performance is indicated in the Electrical Characteristics for the listed test conditions, unless otherwise noted. Product performance may not be indicated by the Electrical Characteristics if operated under different conditions.

NCV952

Table 7. ELECTRICAL CHARACTERISTICS AT $V_S = 24\text{ V}$

At $T_A = +25^\circ\text{C}$, $R_L = 10\text{ k}\Omega$ connected to mid-supply, $V_{CM} = V_{OUT} = \text{mid-supply}$, unless otherwise noted.

Boldface limits apply over the specified temperature range, $T_A = -40^\circ\text{C}$ to $+125^\circ\text{C}$, guaranteed by characterization and/or design.

Parameter	Symbol	Conditions	Min	Typ	Max	Unit
-----------	--------	------------	-----	-----	-----	------

INPUT CHARACTERISTICS

Offset Voltage	V_{OS}			0.6	6.0	mV
					8.0	mV
Offset Voltage Drift	$\Delta V/\Delta T$			4.5		$\mu\text{V}/^\circ\text{C}$
Input Bias Current	I_{IB}			55	100	nA
					200	nA
Input Offset Current	I_{OS}			1.0	30	nA
					80	nA
Input Common Mode Range	V_{CM}		$V_{SS} - 0.2$		$V_{DD} + 0.2$	V
Common Mode Rejection Ratio	CMRR	$V_{SS} + 0.15 < V_{CM} < V_{DD} - 0.15$	50	100		dB

OUTPUT CHARACTERISTICS

Output Voltage High	V_{OH}	$R_L = 2\text{ k}\Omega$	$V_{DD} - 0.30$	$V_{DD} - 0.10$		V
Output Voltage Low	V_{OL}	$R_L = 2\text{ k}\Omega$		$V_{SS} + 0.14$	$V_{SS} + 0.30$	V
Short Circuit Current	I_{SC}		10			mA

NOISE PERFORMANCE

Voltage Noise Density	e_N	$f = 1\text{ kHz}$, no load		25		nV/ $\sqrt{\text{Hz}}$
-----------------------	-------	------------------------------	--	----	--	------------------------

DYNAMIC PERFORMANCE

Open Loop Voltage Gain	A_{VOL}	$V_O = 2\text{ Vpp}$, $R_L = 2\text{ k}\Omega$		88		dB
Gain Bandwidth Product	GBWP	$R_L = 10\text{ k}\Omega$		3.0		MHz
Gain Margin	A_M	$R_L = 10\text{ k}\Omega$, $C_L = 100\text{ pF}$		9.0		dB
Phase Margin	ψ_M	$R_L = 10\text{ k}\Omega$, $C_L = 100\text{ pF}$		70		$^\circ$
Slew Rate	SR	$R_L = 10\text{ k}\Omega$		1.0		V/ μs
Total Harmonic Distortion + Noise	THD+N	$V_{OUT} = 10\text{ Vpp}$, $f_{IN} = 10\text{ kHz}$, $A_V = 2$, $R_L = 10\text{ k}\Omega$		0.013		%

POWER SUPPLY

Power Supply Rejection Ratio	PSRR	$V_S = 2.7\text{ V}$ to 26 V	60	105		dB
Quiescent Current	I_{CC}	No load, $V_{CM} = V_S/2$, per channel		0.95	1.4	mA

Product parametric performance is indicated in the Electrical Characteristics for the listed test conditions, unless otherwise noted. Product performance may not be indicated by the Electrical Characteristics if operated under different conditions.

TYPICAL CHARACTERISTICS

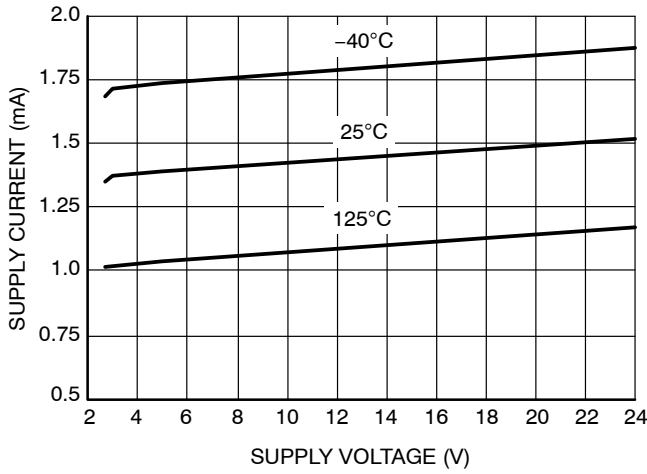

Figure 1. Supply Current vs. Supply Voltage

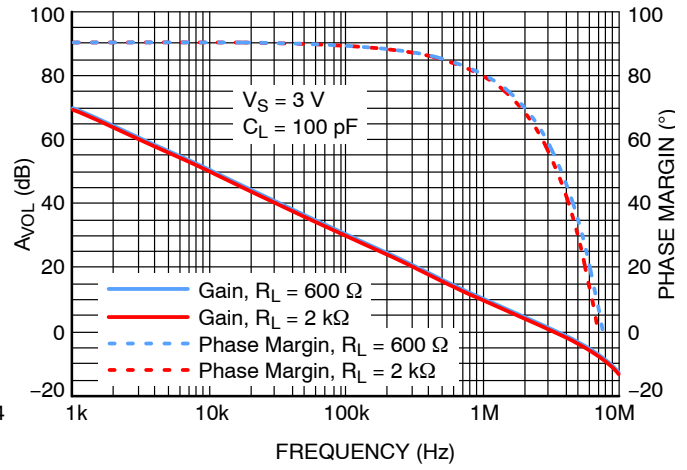

Figure 2. Open Loop Gain and Phase Margin vs. Frequency

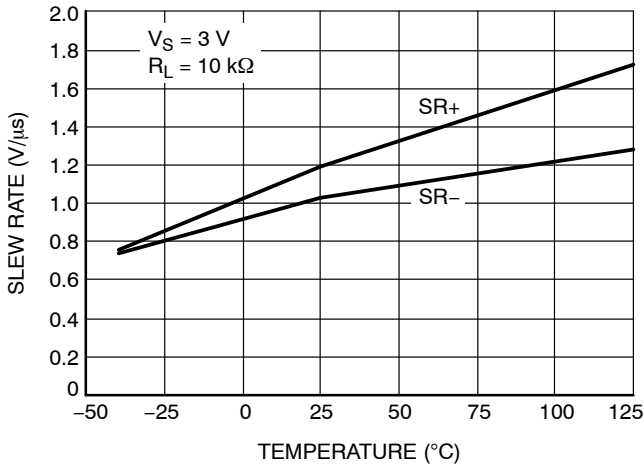

Figure 3. Slew Rate vs. Temperature

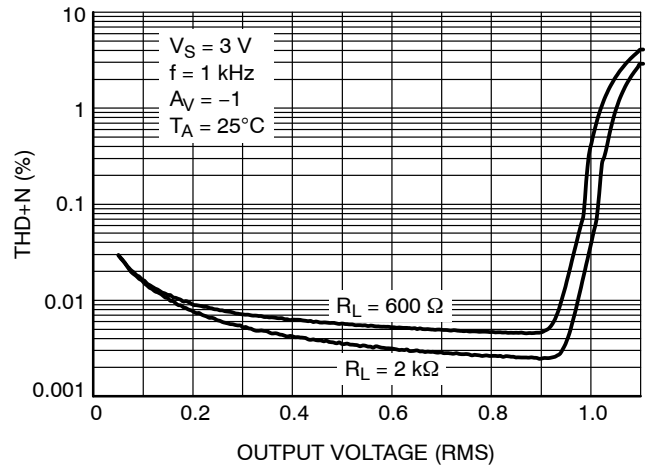

Figure 4. THD+N vs. Output Voltage

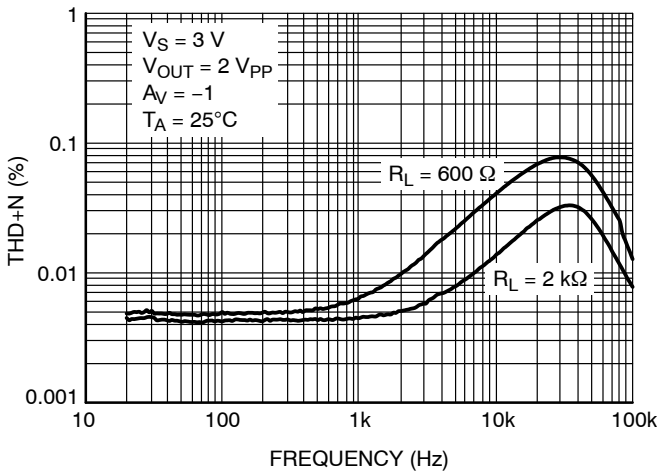

Figure 5. THD+N vs. Frequency

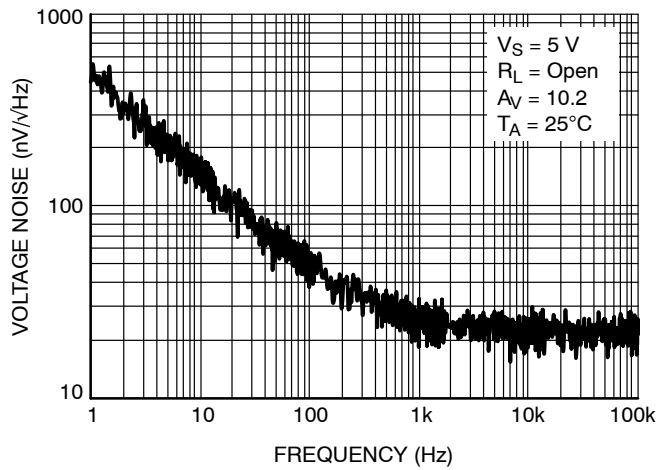

Figure 6. Input Voltage Noise vs. Frequency

TYPICAL CHARACTERISTICS

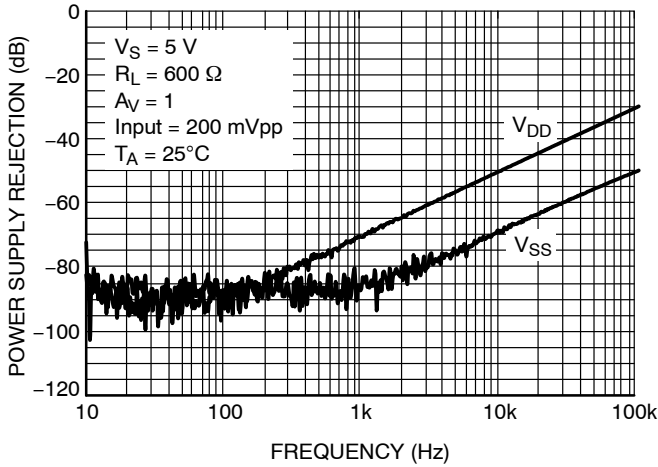

Figure 7. PSRR vs. Frequency

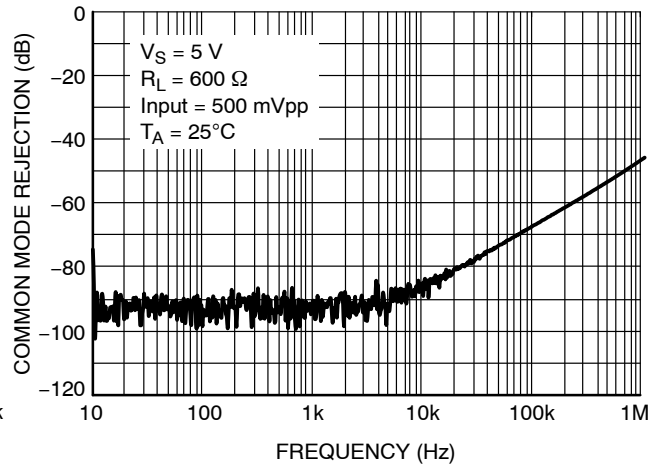

Figure 8. CMRR vs. Frequency

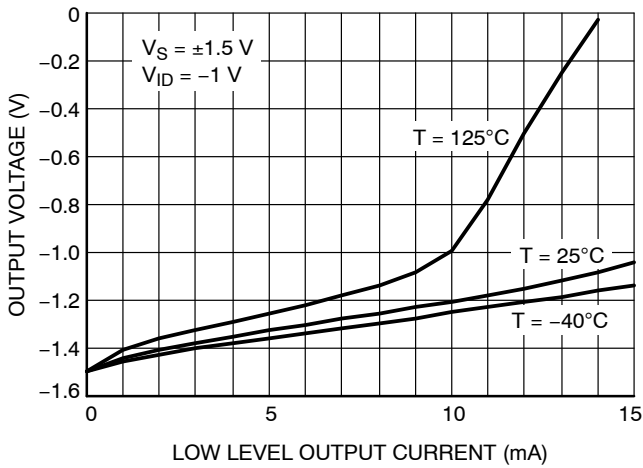

Figure 9. Low Level Output Voltage vs. Output Current at 3 V Supply

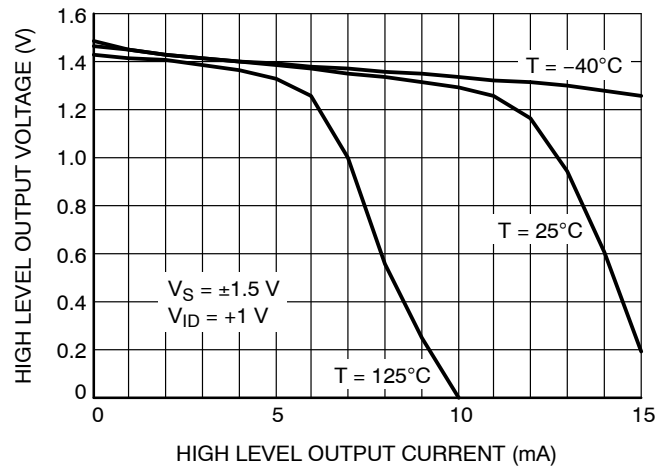

Figure 10. High level Output Voltage vs. Output Current at 3 V Supply

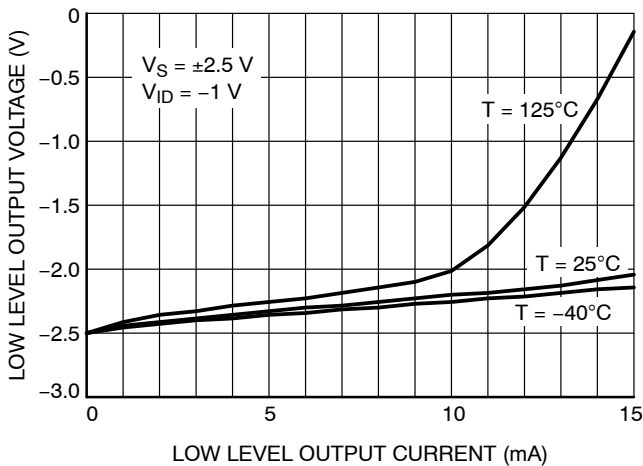

Figure 11. Low Level Output Voltage vs. Output Current at 5 V Supply

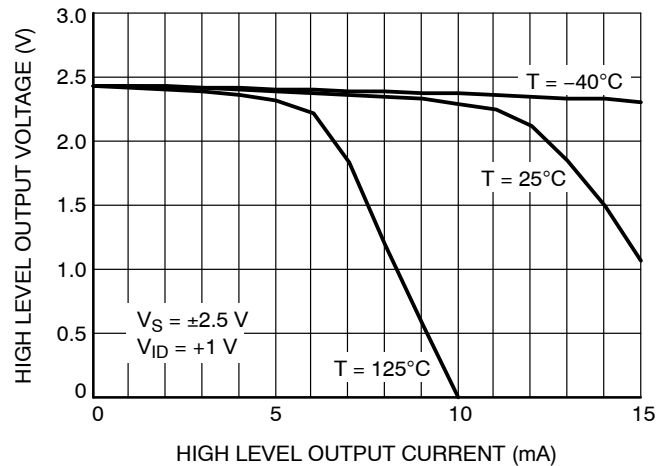

Figure 12. High Level Output Voltage vs. Output Current at 5 V Supply

TYPICAL CHARACTERISTICS

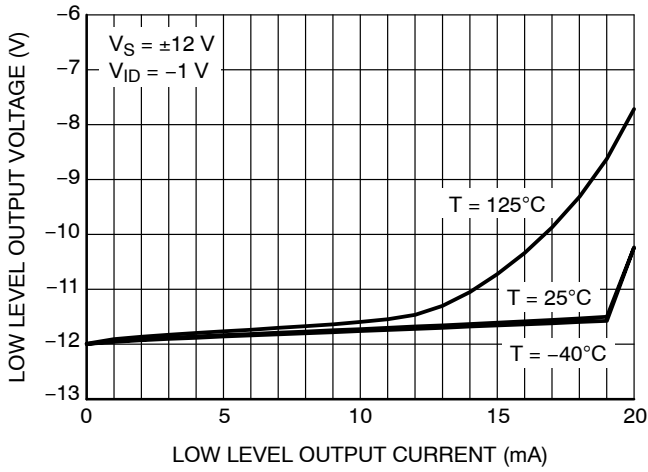

Figure 13. Low Level Output Voltage vs. Output Current at 24 V Supply

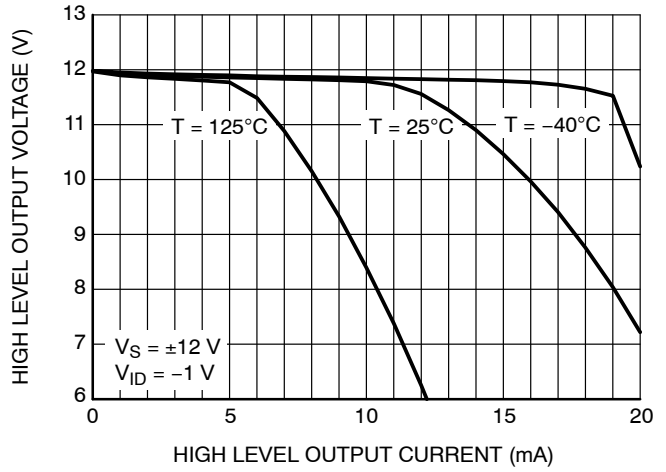

Figure 14. High Level Output Voltage vs. Output Current at 24 V Supply

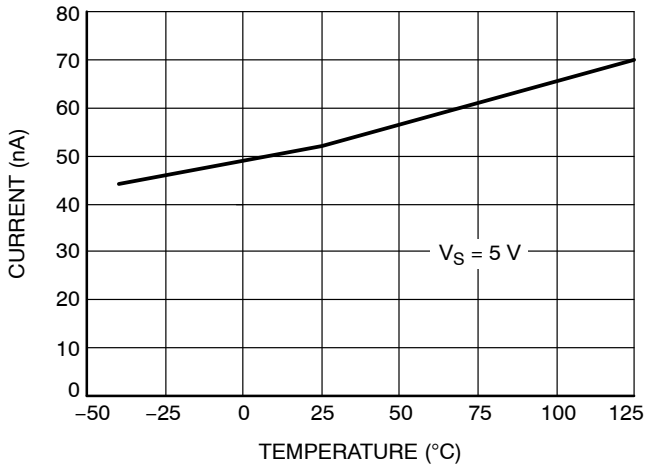

Figure 15. Input Bias Current vs. Temperature

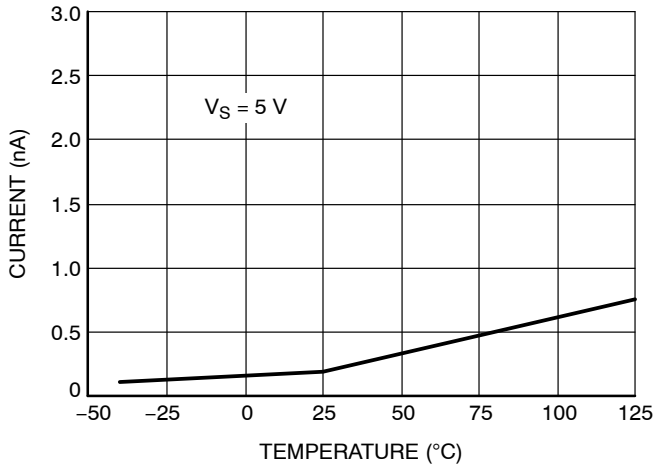

Figure 16. Input Offset Current vs. Temperature

TYPICAL CHARACTERISTICS

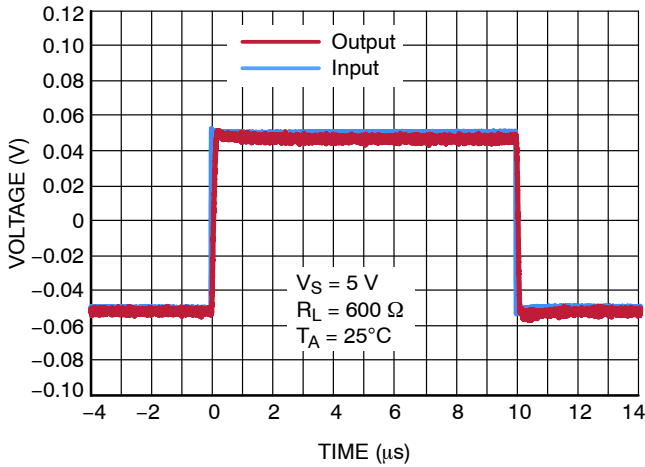

Figure 17. Noninverting Small Signal Transient Response

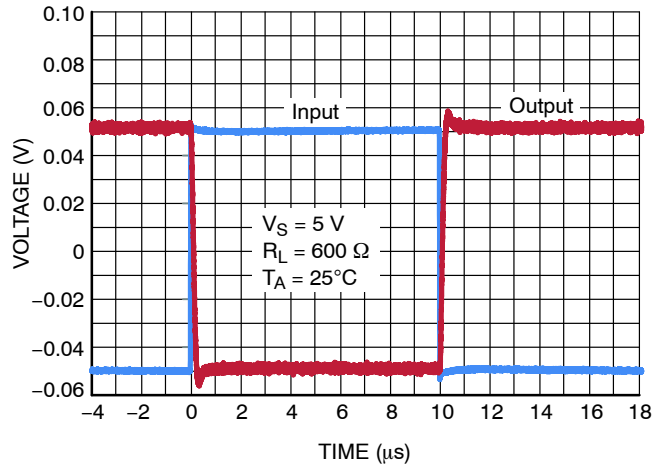

Figure 18. Inverting Small Signal Transient Response

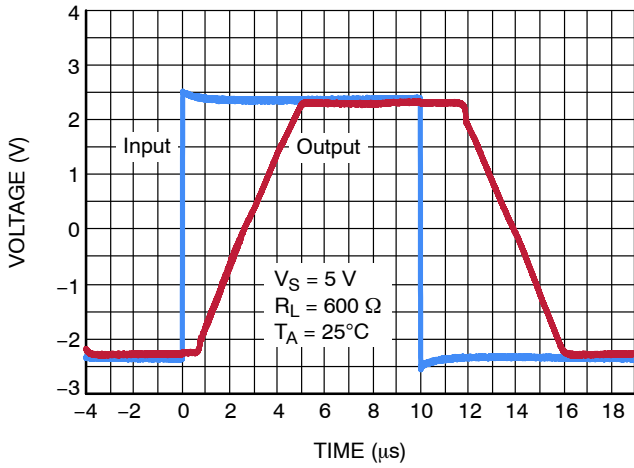

Figure 19. Noninverting Large Signal Transient Response

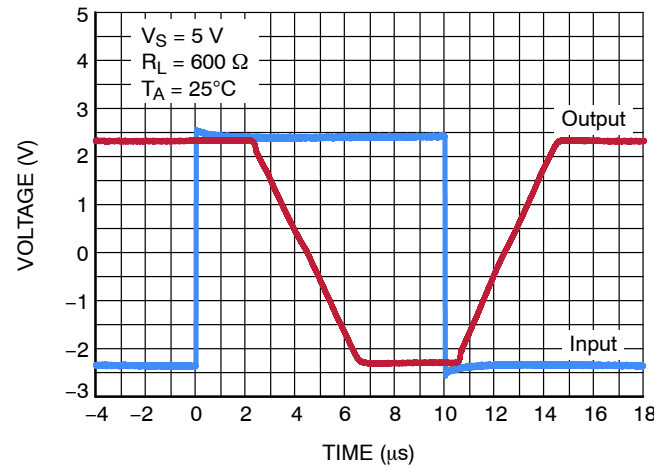
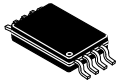

Figure 20. Inverting Large Signal Transient Response

MECHANICAL CASE OUTLINE PACKAGE DIMENSIONS



SCALE 2:1

TSSOP-8
CASE 948S
ISSUE C

DATE 20 JUN 2008

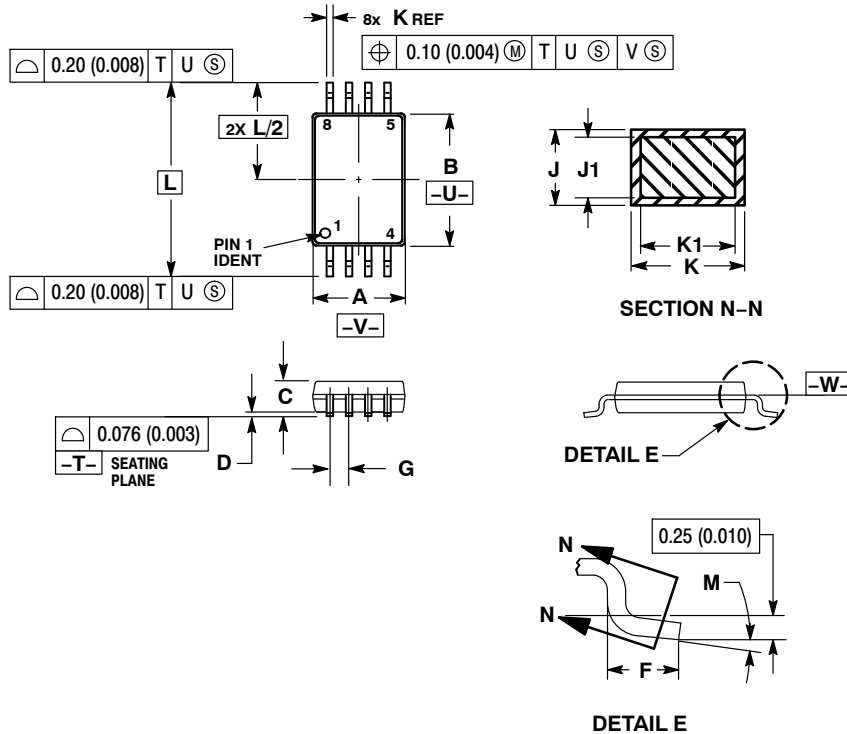

NOTES:

- DIMENSIONING AND TOLERANCING PER ANSI Y14.5M, 1982.
- CONTROLLING DIMENSION: MILLIMETER.
- DIMENSION A DOES NOT INCLUDE MOLD FLASH, PROTRUSIONS OR GATE BURRS. MOLD FLASH OR GATE BURRS SHALL NOT EXCEED 0.15 (0.006) PER SIDE.
- DIMENSION B DOES NOT INCLUDE INTERLEAD FLASH OR PROTRUSION. INTERLEAD FLASH OR PROTRUSION SHALL NOT EXCEED 0.25 (0.010) PER SIDE.
- TERMINAL NUMBERS ARE SHOWN FOR REFERENCE ONLY.
- DIMENSION A AND B ARE TO BE DETERMINED AT DATUM PLANE -W-.

DIM	MILLIMETERS		INCHES	
	MIN	MAX	MIN	MAX
A	2.90	3.10	0.114	0.122
B	4.30	4.50	0.169	0.177
C	---	1.10	---	0.043
D	0.05	0.15	0.002	0.006
F	0.50	0.70	0.020	0.028
G	0.65 BSC		0.026 BSC	
J	0.09	0.20	0.004	0.008
J1	0.09	0.16	0.004	0.006
K	0.19	0.30	0.007	0.012
K1	0.19	0.25	0.007	0.010
L	6.40 BSC		0.252 BSC	
M	0°	8°	0°	8°

GENERIC MARKING DIAGRAM*

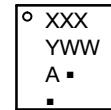

- XXX = Specific Device Code
- A = Assembly Location
- Y = Year
- WW = Work Week
- = Pb-Free Package

*This information is generic. Please refer to device data sheet for actual part marking. Pb-Free indicator, "G" or microdot "▪", may or may not be present. Some products may not follow the Generic Marking.

DOCUMENT NUMBER:	98AON00697D	Electronic versions are uncontrolled except when accessed directly from the Document Repository. Printed versions are uncontrolled except when stamped "CONTROLLED COPY" in red.
DESCRIPTION:	TSSOP-8	PAGE 1 OF 1

onsemi and ONSEMI are trademarks of Semiconductor Components Industries, LLC dba onsemi or its subsidiaries in the United States and/or other countries. onsemi reserves the right to make changes without further notice to any products herein. onsemi makes no warranty, representation or guarantee regarding the suitability of its products for any particular purpose, nor does onsemi assume any liability arising out of the application or use of any product or circuit, and specifically disclaims any and all liability, including without limitation special, consequential or incidental damages. onsemi does not convey any license under its patent rights nor the rights of others.

onsemi, **Onsemi**, and other names, marks, and brands are registered and/or common law trademarks of Semiconductor Components Industries, LLC dba "**onsemi**" or its affiliates and/or subsidiaries in the United States and/or other countries. **onsemi** owns the rights to a number of patents, trademarks, copyrights, trade secrets, and other intellectual property. A listing of **onsemi**'s product/patent coverage may be accessed at www.onsemi.com/site/pdf/Patent-Marking.pdf. **onsemi** reserves the right to make changes at any time to any products or information herein, without notice. The information herein is provided "as-is" and **onsemi** makes no warranty, representation or guarantee regarding the accuracy of the information, product features, availability, functionality, or suitability of its products for any particular purpose, nor does **onsemi** assume any liability arising out of the application or use of any product or circuit, and specifically disclaims any and all liability, including without limitation special, consequential or incidental damages. Buyer is responsible for its products and applications using **onsemi** products, including compliance with all laws, regulations and safety requirements or standards, regardless of any support or applications information provided by **onsemi**. "Typical" parameters which may be provided in **onsemi** data sheets and/or specifications can and do vary in different applications and actual performance may vary over time. All operating parameters, including "Typicals" must be validated for each customer application by customer's technical experts. **onsemi** does not convey any license under any of its intellectual property rights nor the rights of others. **onsemi** products are not designed, intended, or authorized for use as a critical component in life support systems or any FDA Class 3 medical devices or medical devices with a same or similar classification in a foreign jurisdiction or any devices intended for implantation in the human body. Should Buyer purchase or use **onsemi** products for any such unintended or unauthorized application, Buyer shall indemnify and hold **onsemi** and its officers, employees, subsidiaries, affiliates, and distributors harmless against all claims, costs, damages, and expenses, and reasonable attorney fees arising out of, directly or indirectly, any claim of personal injury or death associated with such unintended or unauthorized use, even if such claim alleges that **onsemi** was negligent regarding the design or manufacture of the part. **onsemi** is an Equal Opportunity/Affirmative Action Employer. This literature is subject to all applicable copyright laws and is not for resale in any manner.

ADDITIONAL INFORMATION

TECHNICAL PUBLICATIONS:

Technical Library: www.onsemi.com/design/resources/technical-documentation
onsemi Website: www.onsemi.com

ONLINE SUPPORT: www.onsemi.com/support

For additional information, please contact your local Sales Representative at www.onsemi.com/support/sales

