

NCV8675

Linear Regulator - Low Dropout, Very Low I_q , Reset, Reset Delay

350 mA

The NCV8675 is a precision 5.0 V and 3.3 V fixed output, low dropout integrated voltage regulator with an output current capability of 350 mA. Careful management of light load current consumption, combined with a low leakage process, achieve a typical quiescent ground current of 34 μ A.

NCV8675 is pin for pin compatible with NCV4275 and it could replace this part when very low quiescent current is required.

The output voltage is accurate within $\pm 2.0\%$ for D²PAK-5 package and $\pm 2.5\%$ for DPAK-5 package, and maximum dropout voltage is 600 mV at full rated load current.

It is internally protected against input transients, input supply reversal, output overcurrent faults, and excess die temperature. No external components are required to enable these features.

Features

- 5 V and 3.3 V Fixed Output (2.5 V Version Available Upon Request)
- $\pm 2.0\%$ or $\pm 2.5\%$ Output Accuracy, Over Full Temperature Range
- 34 μ A Typical Quiescent Current at $I_{out} = 100 \mu$ A, 50 μ A Maximum up to 85°C
- 600 mV Maximum Dropout Voltage at 350 mA Load Current
- Wide Input Voltage Operating Range of 4.5 V to 45 V
- Internal Fault Protection
 - ◆ -42 V Reverse Voltage
 - ◆ Short Circuit/Overcurrent
 - ◆ Thermal Overload
- AEC-Q100 Qualified
- EMC Compliant
- NCV Prefix for Automotive and Other Applications Requiring Site and Control Changes
- These are Pb-Free Devices

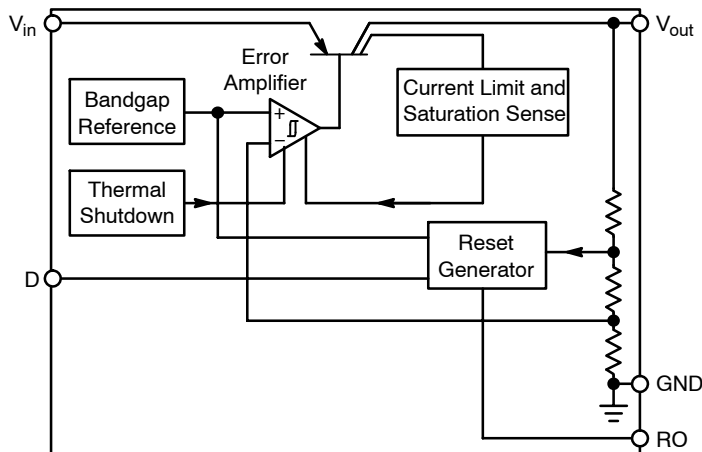

Figure 1. Block Diagram



ON Semiconductor®

<http://onsemi.com>

MARKING DIAGRAMS

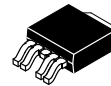

DPAK-5
DT SUFFIX
CASE 175AA

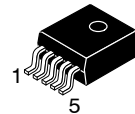
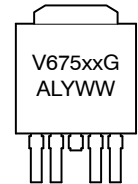

D²PAK-5
DS SUFFIX
CASE 936A

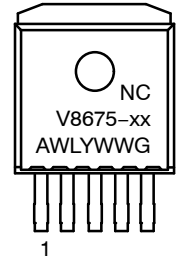

- Pin 1. V_{in}
2. RO
Tab, 3. GND*
4. D
5. V_{out}

* Tab is connected to Pin 3 on all packages

- xx = 50 (5.0 V Version)
33 (3.3 V Version)
A = Assembly Location
WL, L = Wafer Lot
Y = Year
WW = Work Week
G = Pb-Free Package

ORDERING INFORMATION

See detailed ordering and shipping information in the package dimensions section on page 14 of this data sheet.

NCV8675

PIN DESCRIPTIONS

Symbol	Function
V_{in}	Unregulated Input Voltage; 4.5 V to 45 V; Battery Input Voltage. Bypass to GND with a Ceramic Capacitor.
RO	Reset Output; Open Collector Active Reset (Accurate when $V_{in} > 1.0$ V)
GND	Ground; Pin 3 Internally Connected to Tab
D	Reset Delay; Timing Capacitor to GND for Reset Delay Function
V_{out}	Output; 350 mA. 22 μ F, ESR < 9 Ω

MAXIMUM RATINGS

Pin Symbol, Parameter	Symbol	Min	Max	Unit
Input Voltage	V_{in}	-42	45	V
Output Voltage	V_{out}	-0.3	16	V
Reset Output Voltage	V_{RO}	-0.3	25	V
Reset Output Current	I_{RO}	-5.0	5.0	mA
Reset Delay Voltage	V_D	-0.3	7.0	V
Reset Delay Current	I_D	-2.0	2.0	mA
Storage Temperature	T_{Stg}	-55	+150	$^{\circ}$ C
ESD Capability -Human Body Model -Machine Model	- -	4 200		kV V
Storage Temperature	T_{Stg}	-55	+150	$^{\circ}$ C

Stresses exceeding Maximum Ratings may damage the device. Maximum Ratings are stress ratings only. Functional operation above the Recommended Operating Conditions is not implied. Extended exposure to stresses above the Recommended Operating Conditions may affect device reliability.

OPERATING RANGE

Pin Symbol, Parameter	Symbol	Min	Max	Unit
Input Voltage Operating Range	V_{in}	4.5	45	V
Junction Temperature	T_J	-40	150	$^{\circ}$ C

THERMAL RESISTANCE

Parameter		Symbol	Min	Max	Unit
Junction Ambient	D ² PAK	R_{thja}		82.1	$^{\circ}$ C/W
Junction Case	D ² PAK	R_{thjc}		4.3	
Junction Ambient	DPAK	R_{thja}		112.2	$^{\circ}$ C/W
Junction Case	DPAK	R_{thjc}		4.3	

1. 1 oz., 100 mm² copper area.

Pb SOLDERING TEMPERATURE AND MSL

Parameter	Symbol	Min	Max	Unit
Lead Temperature Soldering Reflow (SMD styles only), Pb-Free (Note 2)	T_{sld}		265 pk	$^{\circ}$ C
Moisture Sensitivity Level	MSL	1		-

2. Pb-Free, 60 sec – 150 sec above 217 $^{\circ}$ C, 40 sec maximum at peak.

NCV8675

ELECTRICAL CHARACTERISTICS $V_{in} = 13.5\text{ V}$, $T_J = -40^\circ\text{C}$ to $+150^\circ\text{C}$, unless otherwise specified

Parameter	Symbol	Test Conditions	Min	Typ	Max	Unit	
OUTPUT							
Output Voltage 5.0 V Version	D ² PAK DPAK	V_{out}	$0.1\text{ mA} \leq I_{out} \leq 350\text{ mA}$ (Note 3) $6.0\text{ V} \leq V_{in} \leq 16\text{ V}$	4.900 4.875	5.000 5.000	5.100 5.125	V
Output Voltage 3.3 V Version	D ² PAK DPAK	V_{out}	$0.1\text{ mA} \leq I_{out} \leq 350\text{ mA}$ (Note 3) $4.5\text{ V} \leq V_{in} \leq 16\text{ V}$	3.234 3.217	3.300 3.300	3.366 3.383	V
Output Voltage 5.0 V Version	D ² PAK DPAK	V_{out}	$0.1\text{ mA} \leq I_{out} \leq 200\text{ mA}$ (Note 3) $6.0\text{ V} \leq V_{in} \leq 40\text{ V}$	4.900 4.875	5.000 5.000	5.100 5.125	V
Output Voltage 3.3 V Version	D ² PAK DPAK	V_{out}	$0.1\text{ mA} \leq I_{out} \leq 200\text{ mA}$ (Note 3) $4.5\text{ V} \leq V_{in} \leq 40\text{ V}$	3.234 3.217	3.300 3.300	3.366 3.383	V
Line Regulation		$\frac{\Delta V_{out}}{\text{Versus } V_{in}}$	$I_{out} = 5\text{ mA}$ $6.0\text{ V} \leq V_{in} \leq 28\text{ V}$	-25	5	+25	mV
Load Regulation		$\frac{\Delta V_{out}}{\text{Versus } I_{out}}$	$1.0\text{ mA} \leq I_{out} \leq 350\text{ mA}$ (Note 3)	-40	5	+40	mV
Dropout Voltage 5.0 V Version		$V_{in} - V_{out}$	$I_{out} = 200\text{ mA}$ (Notes 3 and 4) $I_{out} = 350\text{ mA}$ (Notes 3 and 4)	-	215 310	500 600	mV
Quiescent Current		I_q	$I_{out} \leq 100\text{ }\mu\text{A}$ $T_J = 25^\circ\text{C}$ $T_J = -40^\circ\text{C}$ to $+85^\circ\text{C}$ $T_J = 125^\circ\text{C}$		34 34 54	45 50 60	μA
Active Ground Current		I_G (ON)	$I_{out} = 50\text{ mA}$ (Note 3) $I_{out} = 350\text{ mA}$ (Note 3)		1.8 20	3.5 40	mA
Power Supply Rejection		P_{SRR}	$V_{RIPPLE} = 0.5\text{ V}_{PP}$, $F = 100\text{ Hz}$		70		%/V
Output Capacitor for Stability 5.0 V Version		C_{out} ESR	$I_{out} = 0.1\text{ mA}$ to 350 mA	22		9	μF Ω
3.3 V Version		C_{out} ESR		22		7	μF Ω

RESET TIMING D AND OUTPUT R_O

Reset Switching Threshold	V_{out}, t_t		5.0 V Version 3.3 V Version	4.50 2.97	4.65 3.069	4.80 3.168	V
Reset Output Low Voltage	V_{ROL}		$R_{Ext} > 5.0\text{ k}\Omega$, $V_{out} > 1.0\text{ V}$	-	0.20	0.40	V
Reset Output Leakage Current	I_{ROH}		$V_{ROH} = 5.0\text{ V}$ $V_{ROH} = 3.3\text{ V}$	- -	0 0	10 10	μA
Reset Charging Current	$I_{D,C}$		$V_D = 1.0\text{ V}$	2.0	4.0	6.5	μA
Upper Timing Threshold	V_{DU}		-	1.2	1.3	1.4	V
Lower Timing Threshold	V_{LU}				1.24		V
Reset Delay Time 5.0 V Version 3.3 V Version	t_{rd}		$C_D = 47\text{ nF}$	10 10	16 16	22 24	ms
Reset Reaction Time	t_{rr}		$C_D = 47\text{ nF}$		1.5	4.0	μs

PROTECTION

Current Limit	$I_{out(LIM)}$		$V_{out} = 4.5\text{ V}$ (5.0 V Version) $V_{out} = 3.0\text{ V}$ (3.3 V Version)	350 350			mA
Short Circuit Current Limit	$I_{out(SC)}$		$V_{out} = 0\text{ V}$ (Note 3)	100	600		mA
Thermal Shutdown Threshold	T_{TSD}		(Note 5)	150		200	$^\circ\text{C}$

- Use pulse loading to limit power dissipation.
- Dropout voltage = $(V_{in} - V_{out})$, measured when the output voltage has dropped 100 mV relative to the nominal value obtained with $V_{in} = 13.5\text{ V}$.
- Not tested in production. Limits are guaranteed by design.

TYPICAL CHARACTERISTIC CURVES – 5 V Version

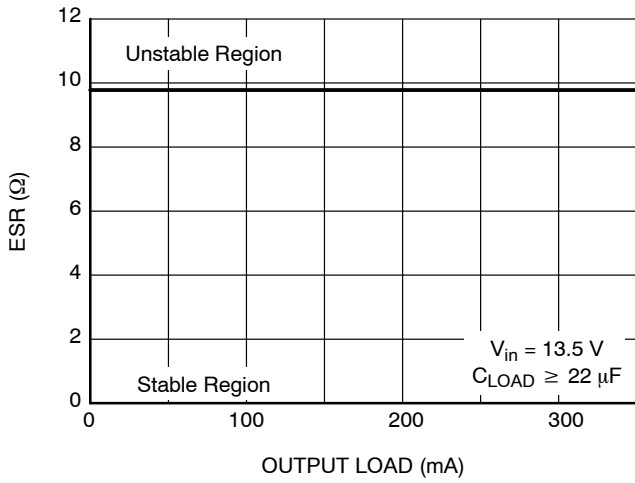

Figure 2. NCV8675 Stability Curve (5 V Version)

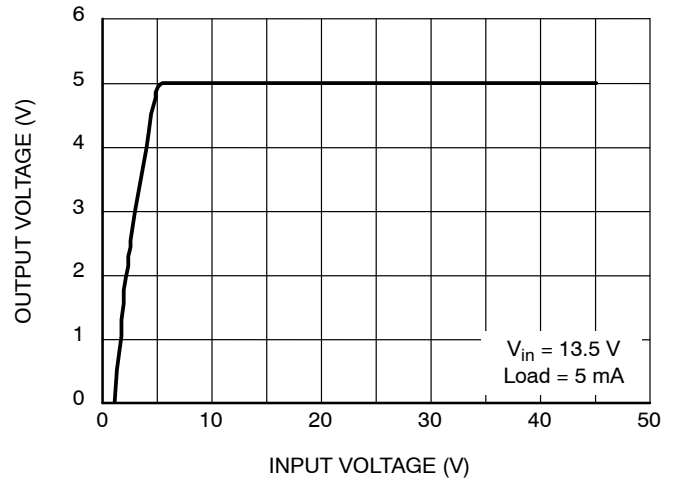

Figure 3. NCV8675 Input Voltage vs. Output Voltage (Full Range) (5 V Version)

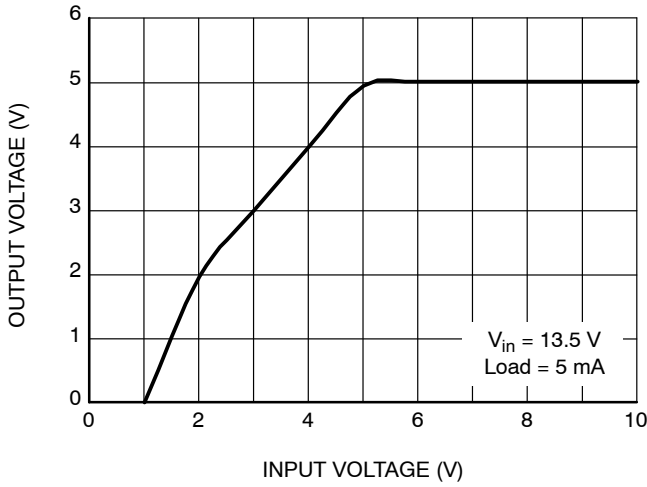

Figure 4. NCV8675 Input Voltage vs. Output Voltage (Low Voltage) (5 V Version)

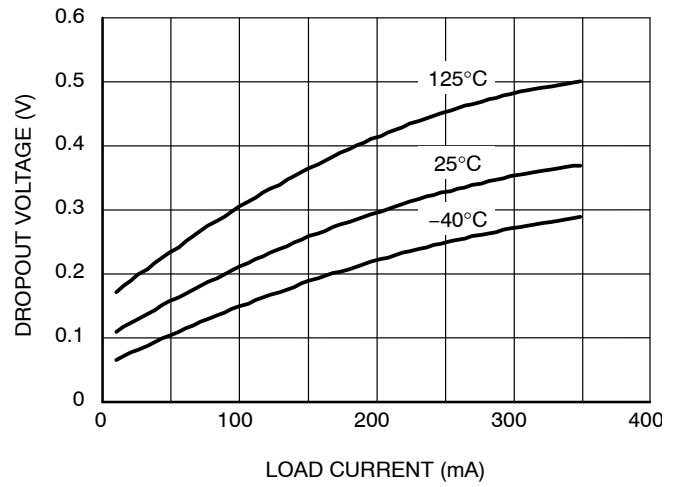

Figure 5. NCV8675 Dropout Voltage vs. Load Current (5 V Version)

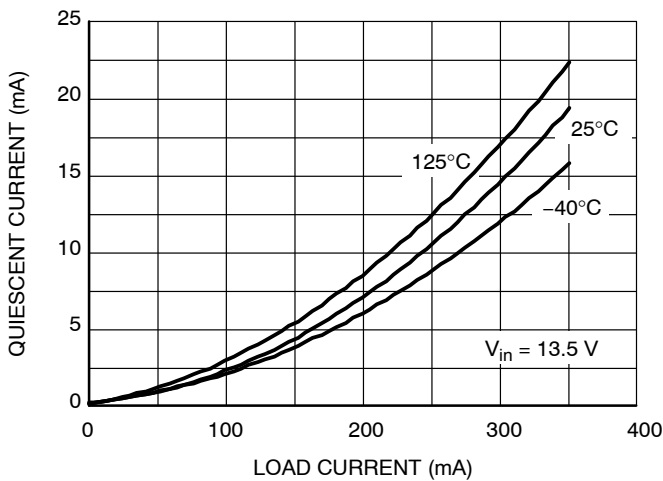

Figure 6. NCV8675 Quiescent Current vs. Load Current (Full Range) (5 V Version)

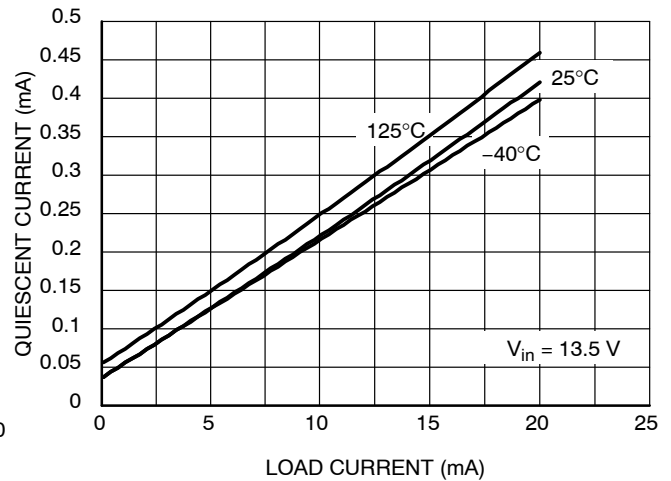

Figure 7. NCV8675 Quiescent Current vs. Load Current (Light Load) (5 V Version)

TYPICAL CHARACTERISTIC CURVES – 5 V Version

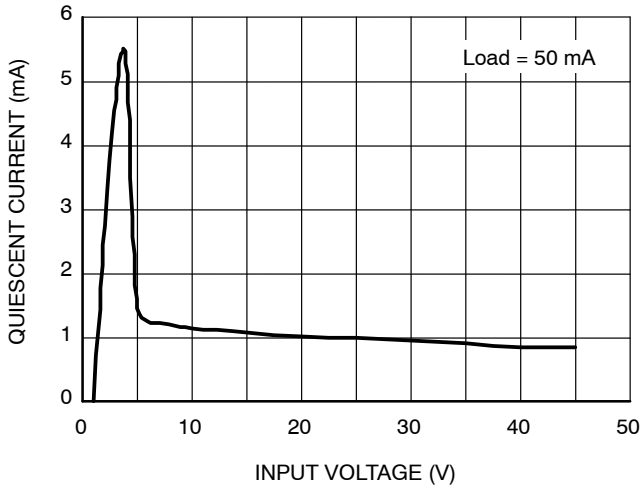

Figure 8. NCV8675 Quiescent Current vs. Input Voltage (5 V Version)

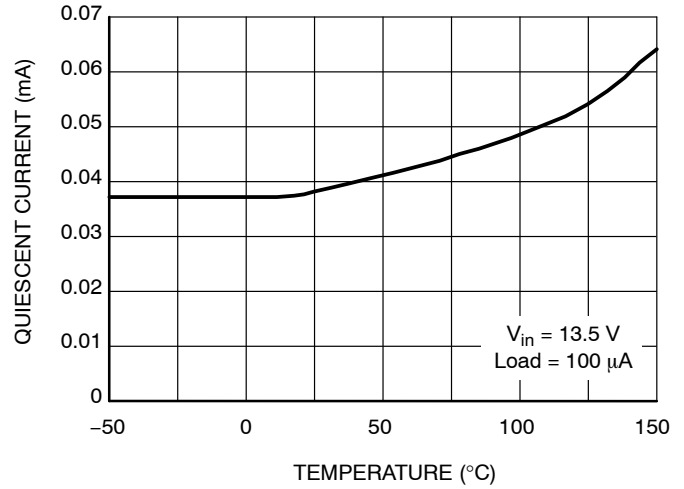

Figure 9. NCV8675 Quiescent Current vs. Temperature (5 V Version)

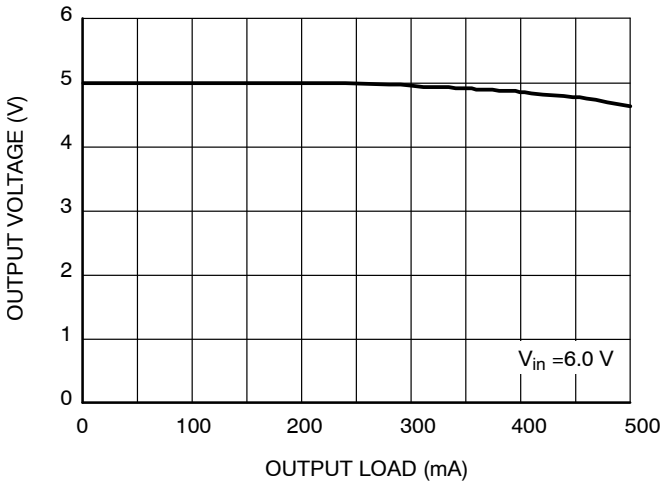

Figure 10. NCV8675 Output Voltage vs. Output Load (5 V Version)

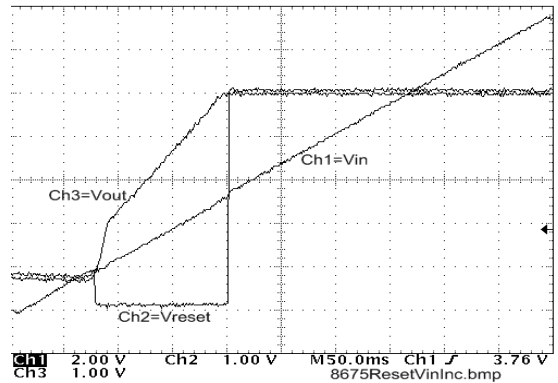

Figure 11. Reset vs. Output Voltage (V_{in} Rising) (5 V Version)

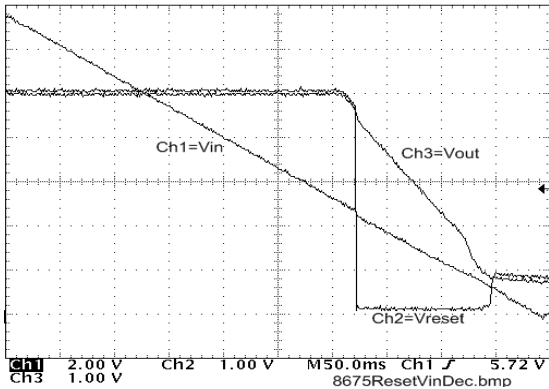

Figure 12. Reset vs. Output Voltage (V_{in} Falling) (5 V Version)

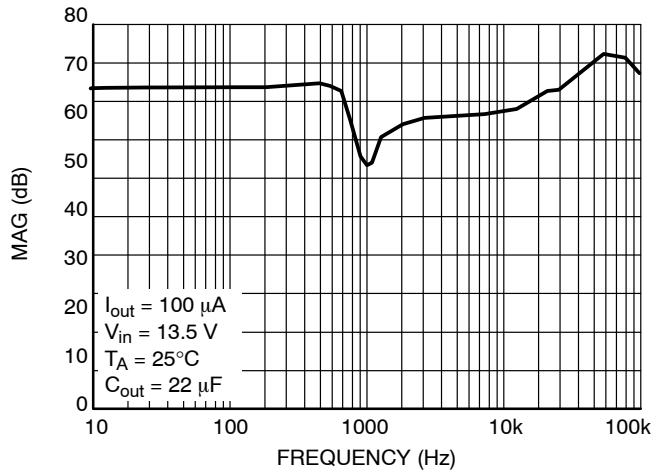

Figure 13. Power Supply Rejection Ratio (5 V Version)

NCV8675

TYPICAL CHARACTERISTIC CURVES – 5 V Version

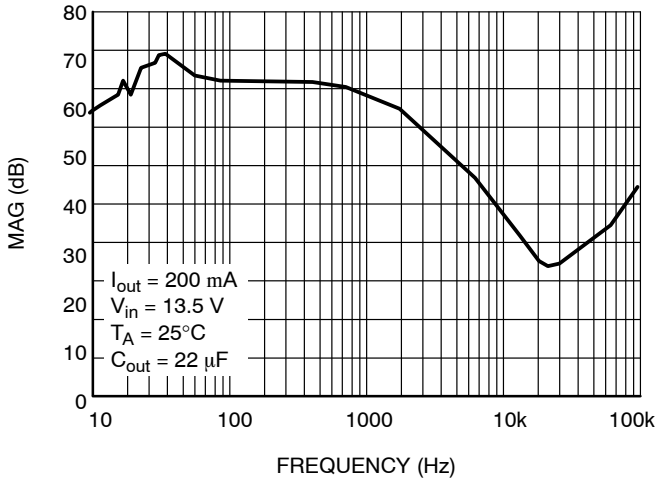

Figure 14. Power Supply Rejection Ratio (5 V Version)

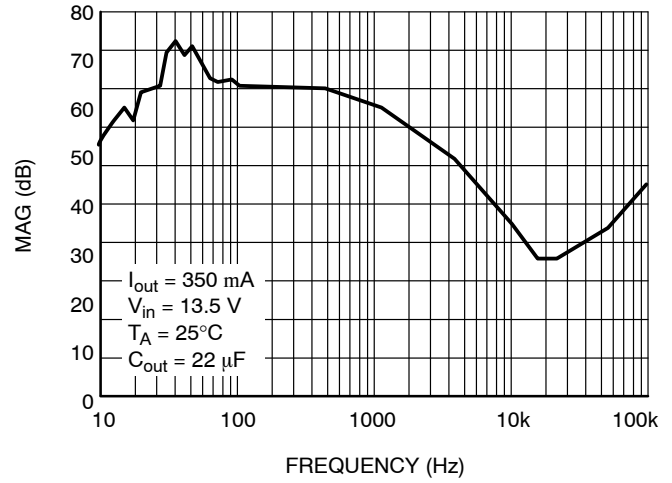

Figure 15. Power Supply Rejection Ratio (5 V Version)

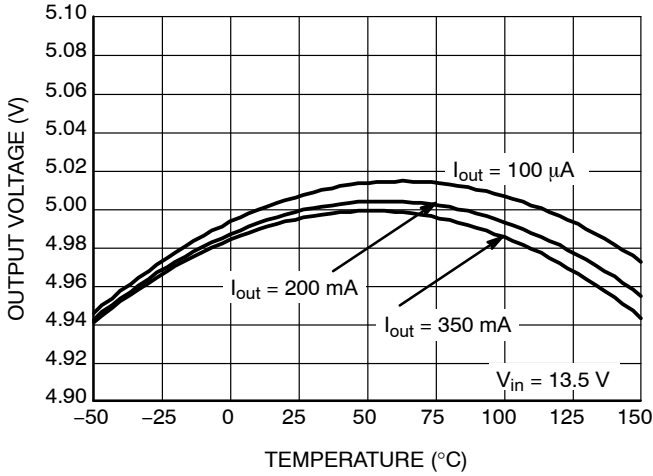

Figure 16. NCV8675 Output Voltage vs. Temperature (5 V Version)

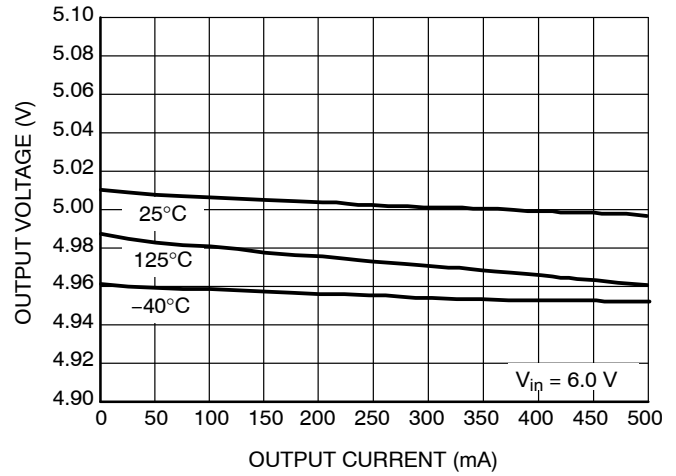

Figure 17. NCV8675 Output Voltage vs. Output Load (5 V Version)

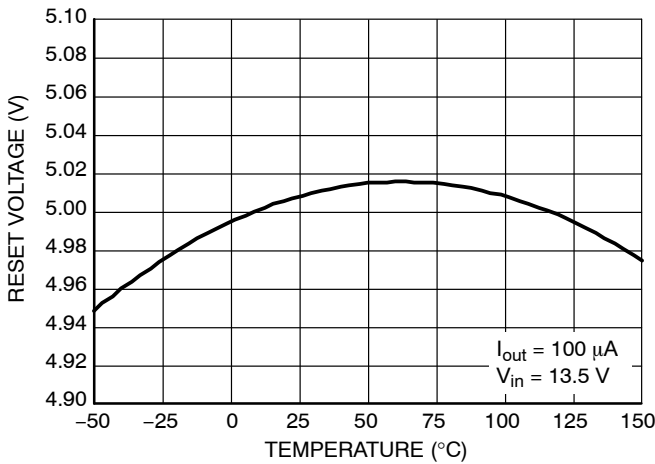

Figure 18. NCV8675 Reset Voltage vs. Temperature (5 V Version)

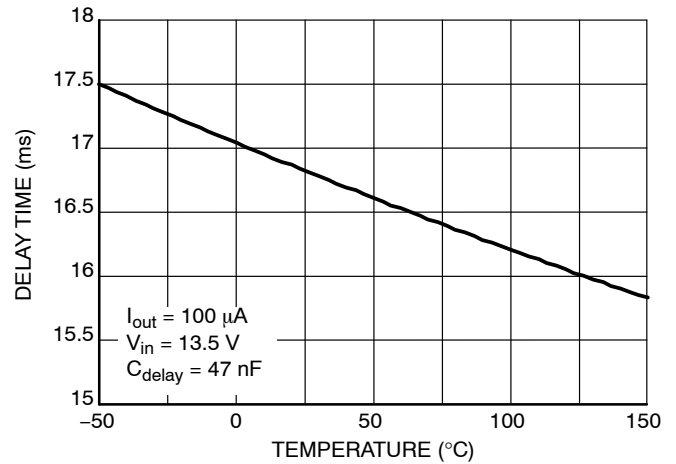

Figure 19. NCV8675 Reset Delay Time vs. Temperature (5 V Version)

NCV8675

TYPICAL CHARACTERISTIC CURVES – 5 V Version

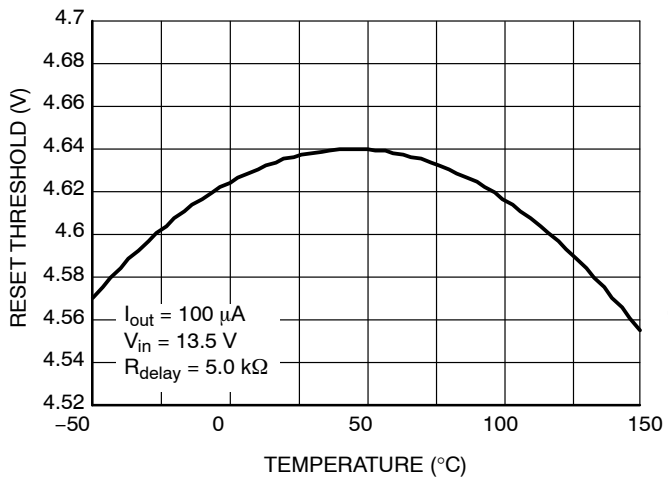

Figure 20. NCV8675 Reset Threshold vs. Temperature (5 V Version)

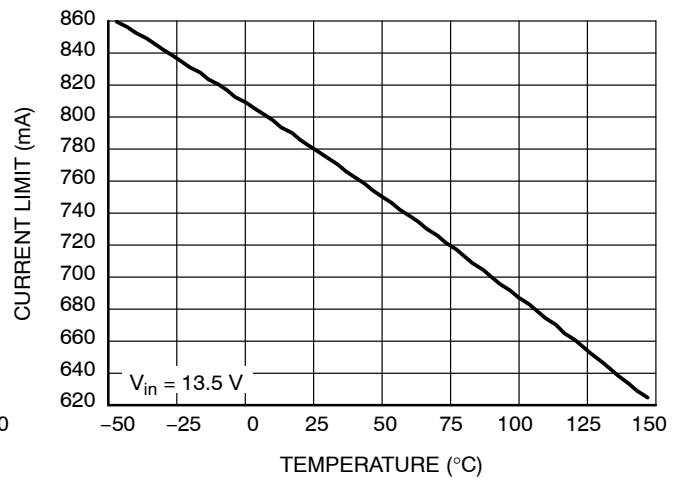

Figure 21. NCV8675 Current Limit Threshold vs. Temperature (5 V Version)

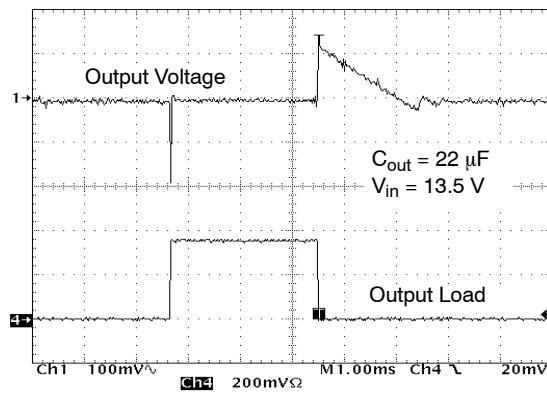

Figure 22. NCV8675 100 μA – 350 mA Load Transient (5 V Version)

TYPICAL CHARACTERISTIC CURVES – 3.3 V Version

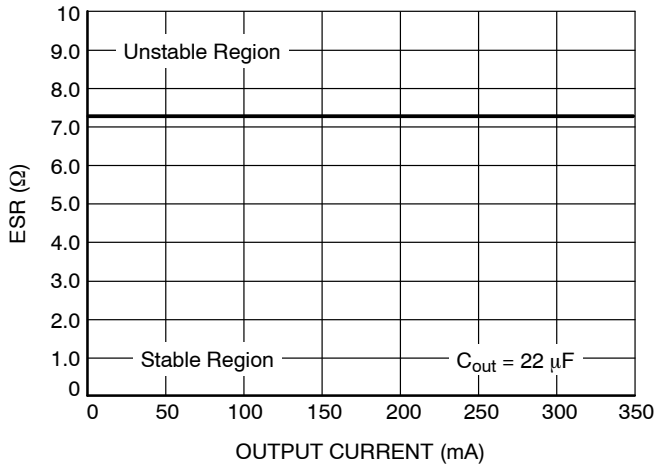

Figure 23. ESR Stability vs. Output Current (3.3 V Version)

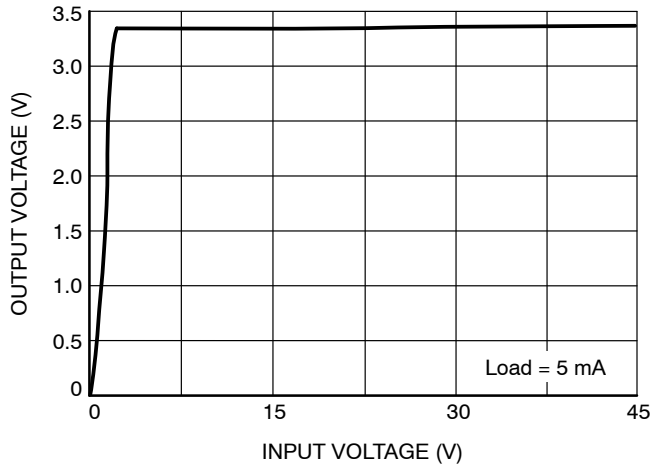

Figure 24. Input Voltage vs. Output Voltage (3.3 V Version)

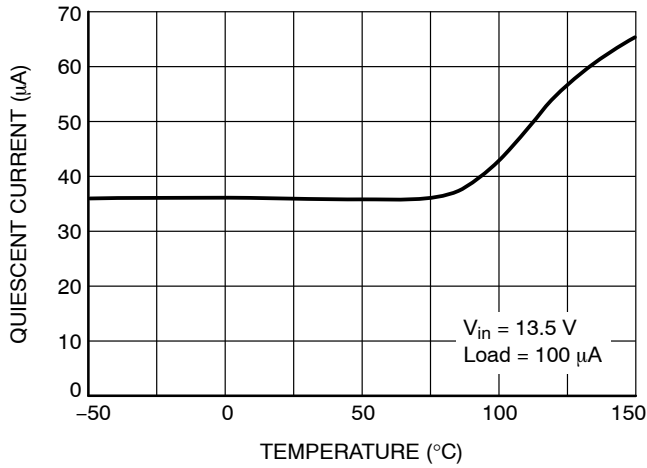

Figure 25. Quiescent Current vs. Temperature (3.3 V Version)

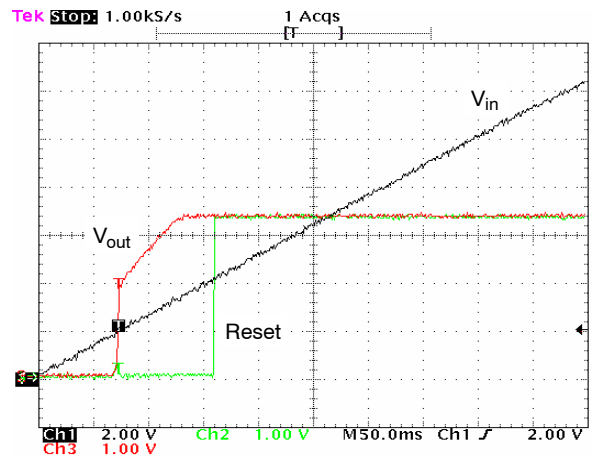

Figure 26. Reset vs. Output Voltage (V_{in} Rising) (3.3 V Version)

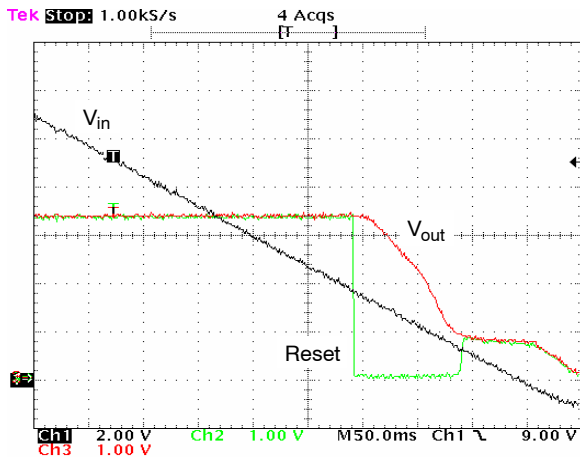

Figure 27. Reset vs. Output Voltage (V_{in} Falling) (3.3 V Version)

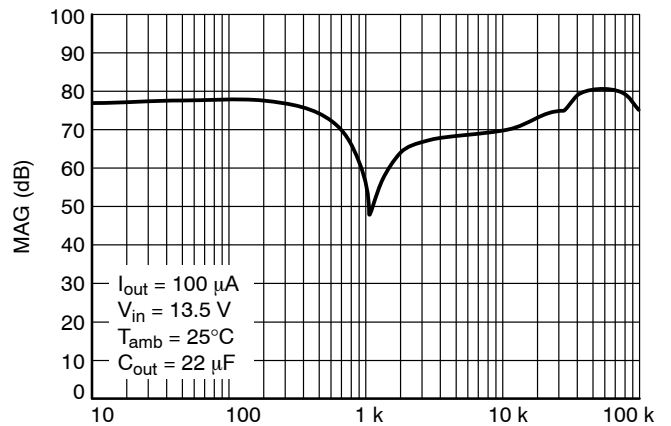

Figure 28. Power Supply Rejection Ratio (3.3 V Version)

TYPICAL CHARACTERISTIC CURVES – 3.3 V Version

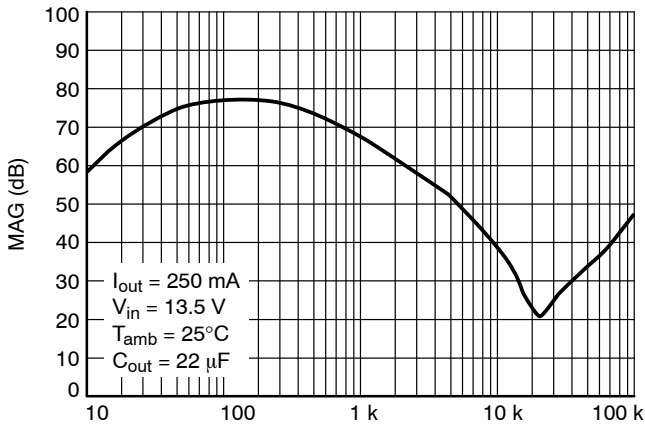

Figure 29. Power Supply Rejection Ratio (3.3 V Version)

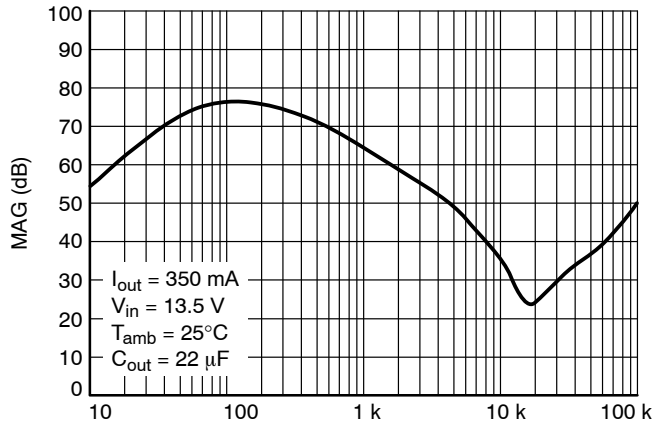

Figure 30. Power Supply Rejection Ratio (3.3 V Version)

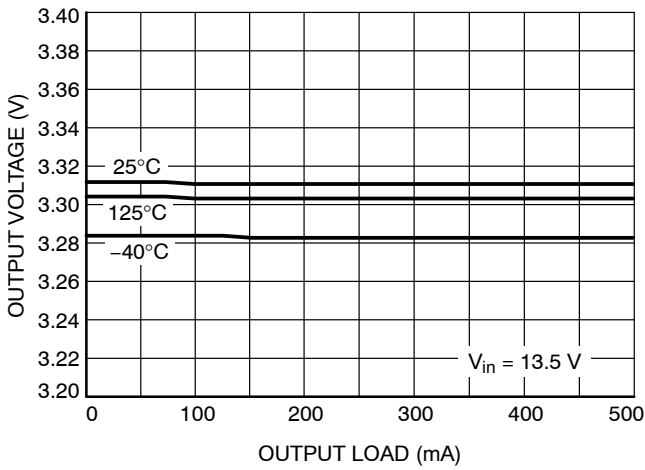

Figure 31. Output Voltage vs. Output Load (3.3 V Version)

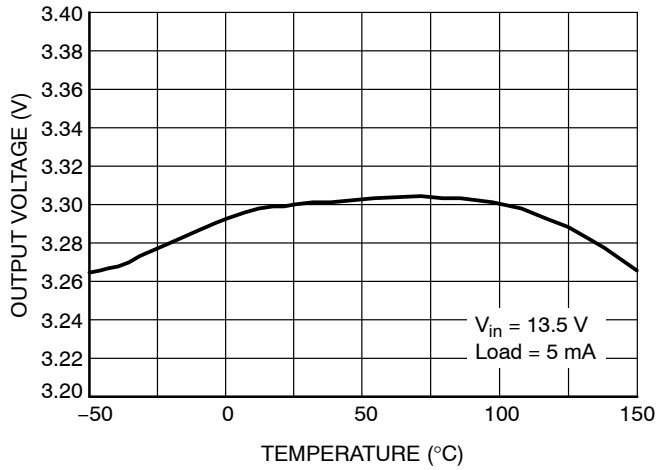

Figure 32. Output Voltage vs. Temperature (3.3 V Version)

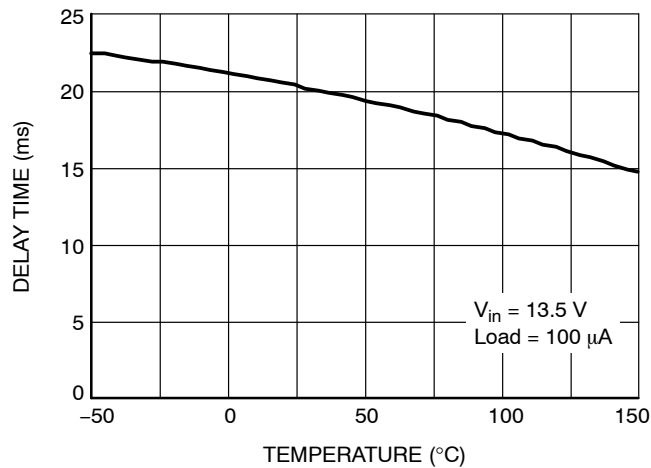

Figure 33. Reset Delay Time vs. Temperature (3.3 V Version)

NCV8675

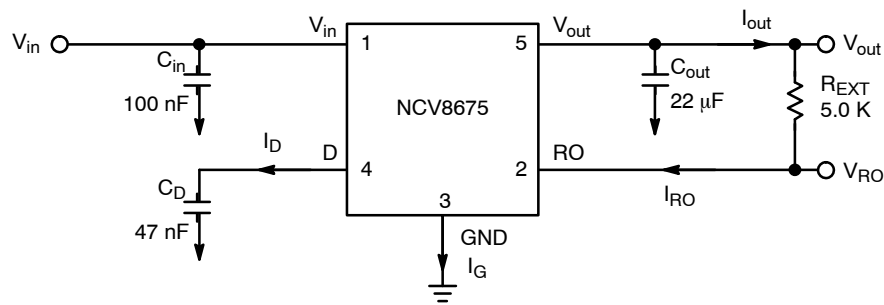

Figure 34. Application Circuits

Circuit Description

The NCV8675 is an integrated low dropout regulator that provides 5.0 V 350 mA, or 3.3 V 350 mA protected output and a signal for power on reset. The regulation is provided by a PNP pass transistor controlled by an error amplifier with a bandgap reference, which gives it the lowest possible drop out voltage and best possible temperature stability. The output current capability is 350 mA, and the base drive quiescent current is controlled to prevent over saturation when the input voltage is low or when the output is overloaded. The regulator is protected by both current limit and thermal shutdown. Thermal shutdown occurs above 150°C to protect the IC during overloads and extreme ambient temperatures. The delay time for the reset output is adjustable by selection of the timing capacitor. See Figure 34, Test Circuit, for circuit element nomenclature illustration.

Regulator

The error amplifier compares the reference voltage to a sample of the output voltage (V_{out}) and drives the base of a PNP series pass transistor by a buffer. The reference is a bandgap design to give it a temperature-stable output. Saturation control of the PNP is a function of the load current and input voltage. Oversaturation of the output power device is prevented, and quiescent current in the ground pin is minimized.

Regulator Stability Considerations

The input capacitor (C_{in}) is necessary to stabilize the input impedance to avoid voltage line influences. The output capacitor helps determine three main characteristics of a linear regulator: startup delay, load transient response and loop stability. The capacitor value and type should be based on cost, availability, size and temperature constraints. Ceramic, tantalum, or electrolytic capacitors of 22 μ F, or greater, are stable with very low ESR values. Refer to

Figure 2 for specific ESR ratings. The aluminum electrolytic capacitor is the least expensive solution, but, if the circuit operates at low temperatures (-25°C to -40°C), both the capacitance and ESR of the capacitor will vary considerably. The capacitor manufacturer's data sheet usually provides this information. The value for the output capacitor C_{out} shown in Figure 13, Test Circuit, should work for most applications; however, it is not necessarily the optimized solution.

Reset Output

The reset output is used as the power on indicator to the microcontroller. This signal indicates when the output voltage is suitable for reliable operation of the controller. It pulls low when the output is not considered to be ready. RO is pulled up to V_{out} by an external resistor, typically 5.0 k Ω in value. The input and output conditions that control the Reset Output and the relative timing are illustrated in Figure 35, Reset Timing. Output voltage regulation must be maintained for the delay time before the reset output signals a valid condition. The delay for the reset output is defined as the amount of time it takes the timing capacitor on the delay pin to charge from a residual voltage of 0 V to the upper timing threshold voltage V_{DU} of 1.3 V. The charging current for this is I_D of 4 μ A and D pin voltage in steady state is typically 2.4 V. By using typical IC parameters with a 47 nF capacitor on the D Pin, the following time delay is derived:

$$t_{RD} = C_D * V_{DU} / I_D$$

$$t_{RD} = 47 \text{ nF} * (1.3 \text{ V}) / 4 \mu\text{A} = 15.3 \text{ ms}$$

Other time delays can be obtained by changing the C_D capacitor value. The Delay Time can be reduced by decreasing the capacitance of C_D . Using the formula above, Delay can be reduced as desired. Leaving the Delay Pin open is not desirable as it can result in unwanted signals being coupled onto the pin.

NCV8675

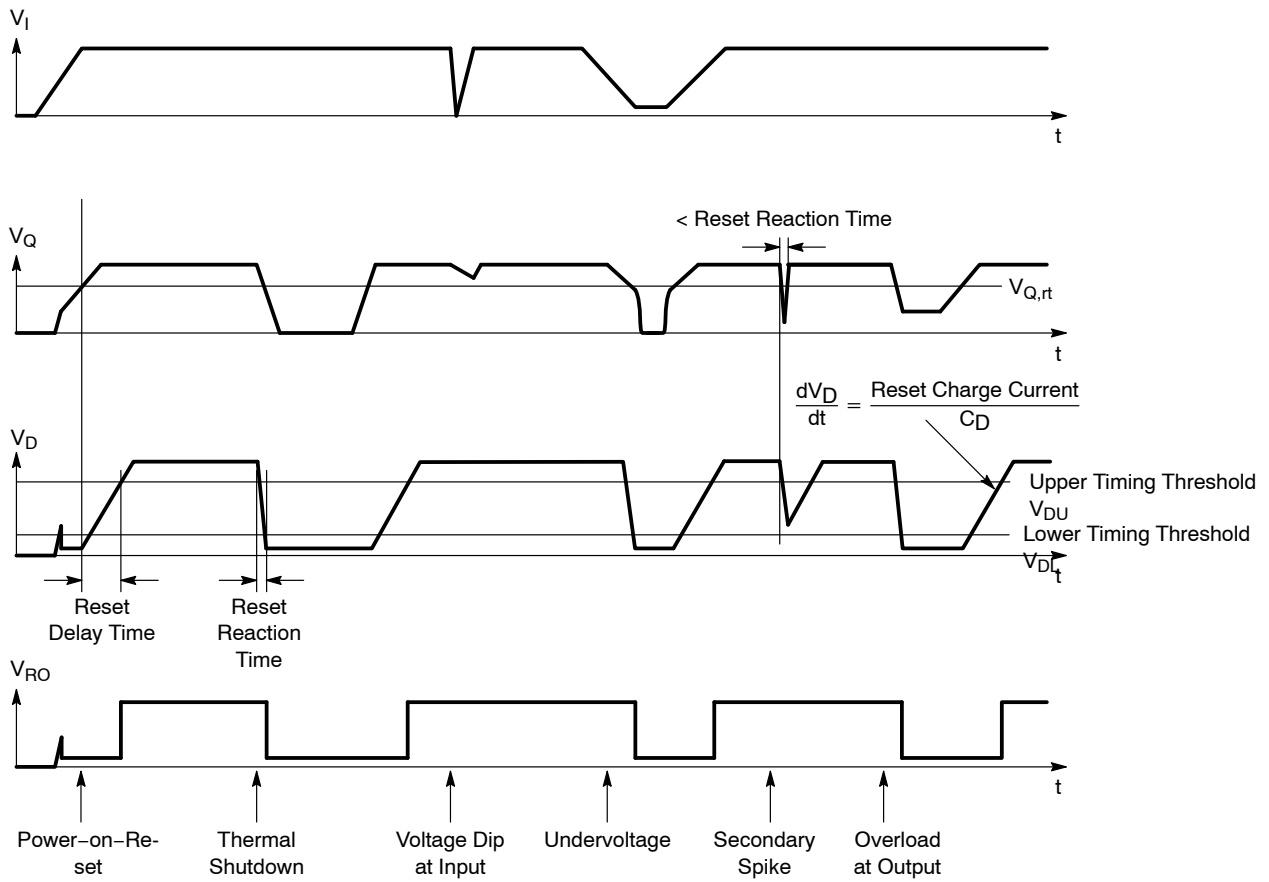

Figure 35. Reset Timing

Calculating Power Dissipation in a Single Output Linear Regulator

The maximum power dissipation for a single output regulator (Figure 36) is:

$$P_{D(max)} = [V_{in(max)} - V_{out(min)}]I_{out(max)} + V_{I(max)}I_q \quad (1)$$

where

- $V_{in(max)}$ is the maximum input voltage,
- $V_{out(min)}$ is the minimum output voltage,
- $I_{out(max)}$ is the maximum output current for the application,
- I_q is the quiescent current the regulator consumes at $I_{Q(max)}$.

Once the value of $P_{D(max)}$ is known, the maximum permissible value of $R_{\theta JA}$ can be calculated:

$$R_{\theta JA} = \frac{150^{\circ}C - T_A}{P_D} \quad (2)$$

The value of $R_{\theta JA}$ can then be compared with those in the package section of the data sheet. Those packages with $R_{\theta JA}$'s less than the calculated value in Equation 2 will keep the die temperature below 150°C.

In some cases, none of the packages will be sufficient to dissipate the heat generated by the IC, and an external heatsink will be required.

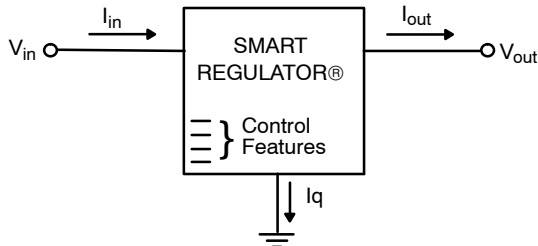

Figure 36. Single Output Regulator with Key Performance Parameters Labeled

Heatsinks

A heatsink effectively increases the surface area of the package to improve the flow of heat away from the IC and into the surrounding air.

Each material in the heat flow path between the IC and the outside environment will have a thermal resistance. Like series electrical resistances, these resistances are summed to determine the value of $R_{\theta JA}$:

$$R_{\theta JA} = R_{\theta JC} + R_{\theta CS} + R_{\theta SA} \quad (3)$$

where

- $R_{\theta JC}$ is the junction-to-case thermal resistance,
- $R_{\theta CS}$ is the case-to-heatsink thermal resistance,
- $R_{\theta SA}$ is the heatsink-to-ambient thermal resistance.

$R_{\theta JC}$ appears in the package section of the data sheet. Like $R_{\theta JA}$, it too is a function of package type. $R_{\theta CS}$ and $R_{\theta SA}$ are functions of the package type, heatsink and the interface between them. These values appear in heatsink data sheets of heatsink manufacturers.

Thermal, mounting, and heatsinking considerations are discussed in the ON Semiconductor application note AN1040/D.

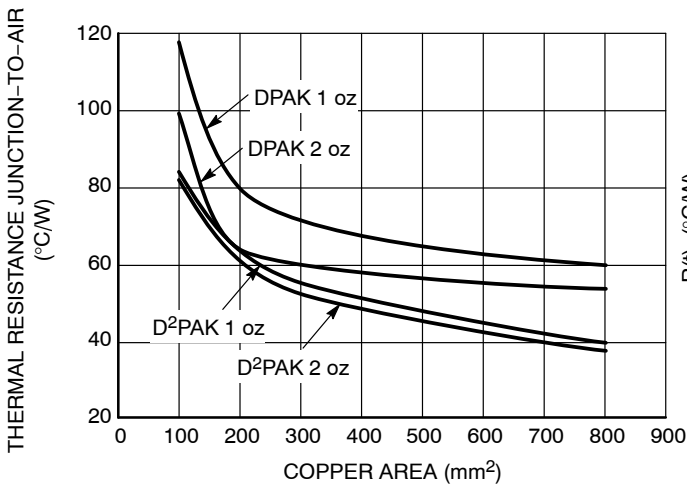
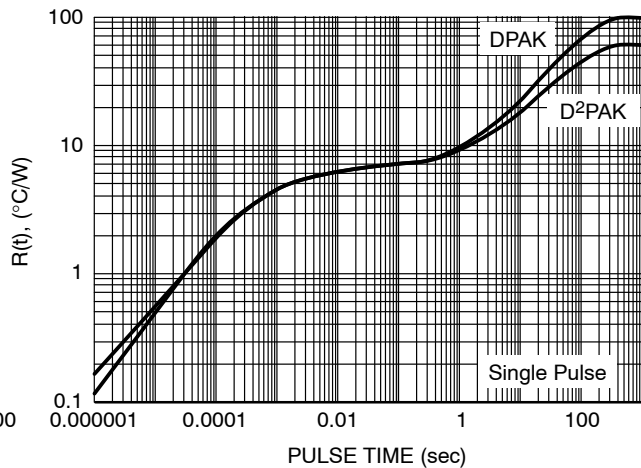

Figure 37. JA vs. Copper Spreader Area



**Figure 38. NCV8675 @ PCB Cu Area 100 mm²
PCB Cu thk 1 oz**

NCV8675

EMC-Characteristics: Conducted Susceptibility

All EMC-Characteristics are based on limited samples and no part of production test according to 47A/658/CD IEC62132-4 (direct Power Injection).

Test Conditions

Supply Voltage $V_{in} = 12\text{ V}$
 Temperature $T_A = 23^\circ\text{C} + -5^\circ\text{C}$
 Load $R_L = 100\ \Omega$

Direct power Injection

33d Bm (Note 1) forward power CW for global pin (Note 2)
 17 dBm (Note 1) forward power CW for local pin (Note 3)

Acceptance Criteria

Amplitude Dev. max 4% of Output Voltage
 Reset outputs remain in correct state + -1 V

1. dBm means dB milli-Watts, $P_{(\text{dBm})} = 10 \log(P_{(\text{mW})})$
2. A global pin carries a signal or power which enters or leaves the application board
3. A local pin carries a signal or power which does not leave the application board. It remains on the application board as a signal between two components

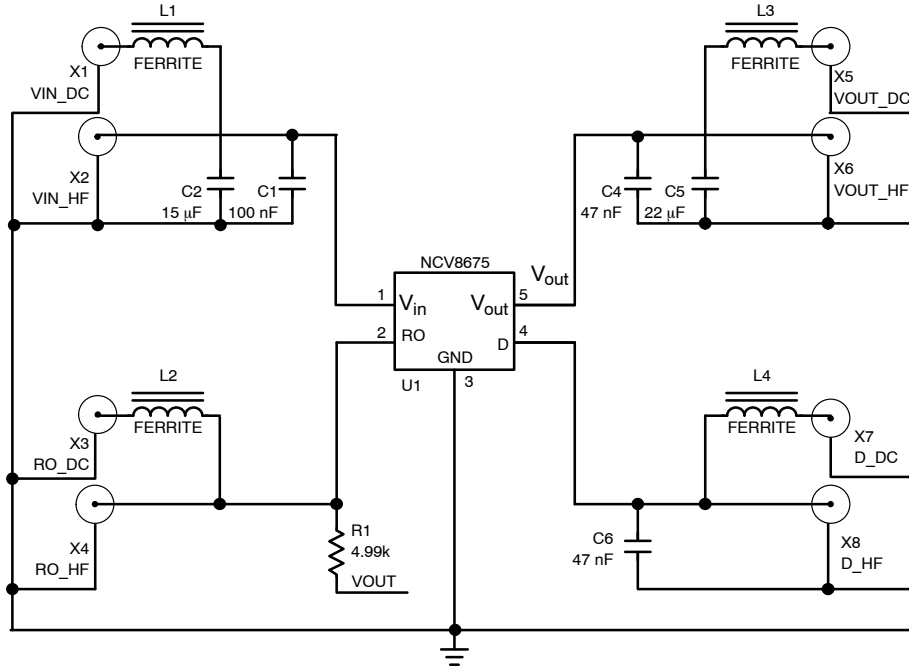

Figure 39. Test Circuit

NCV8675

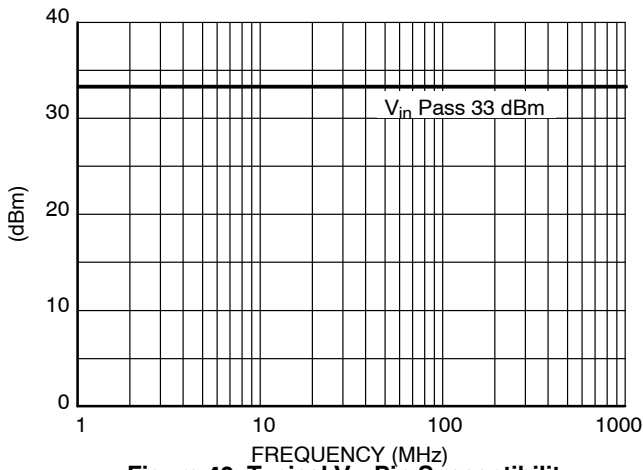

Figure 40. Typical V_{in} Pin Susceptibility

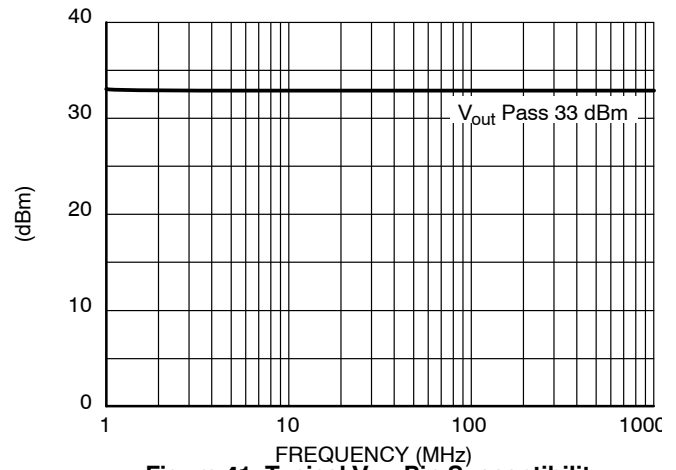

Figure 41. Typical V_{out} Pin Susceptibility

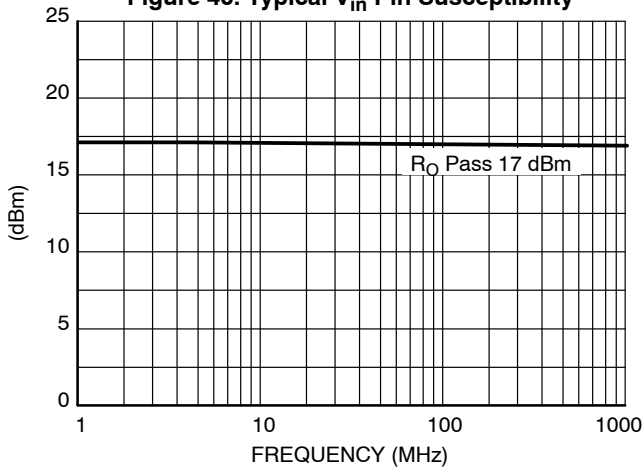

Figure 42. Typical R_O Pin Susceptibility

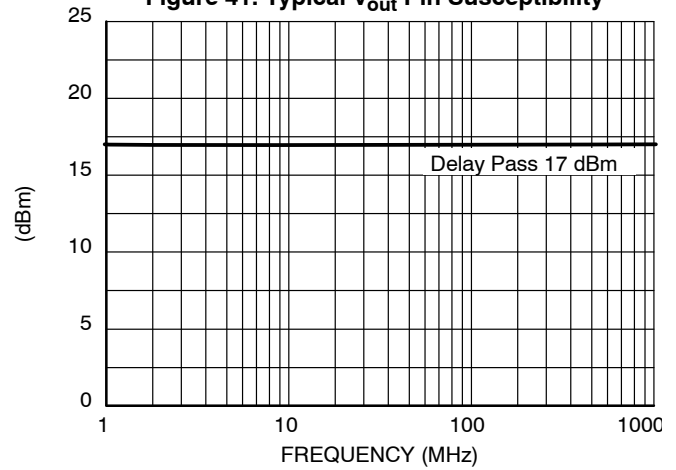
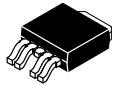

Figure 43. Typical Delay Pin Susceptibility

ORDERING INFORMATION

Device	Output Voltage	Package	Shipping [†]
NCV8675DS50G	5.0 V	D ² PAK (Pb-Free)	50 Units / Rail
NCV8675DS50R4G			800 / Tape & Reel
NCV8675DT50RKG		DPAK (Pb-Free)	2500 / Tape & Reel
NCV8675DS33G	3.3 V	D ² PAK (Pb-Free)	50 Units / Rail
NCV8675DS33R4G			800 / Tape & Reel
NCV8675DT33RKG		DPAK (Pb-Free)	2500 / Tape & Reel

[†]For information on tape and reel specifications, including part orientation and tape sizes, please refer to our Tape and Reel Packaging Specifications Brochure, BRD8011/D.



DPAK-5, CENTER LEAD CROP
CASE 175AA
ISSUE B

DATE 15 MAY 2014

SCALE 1:1

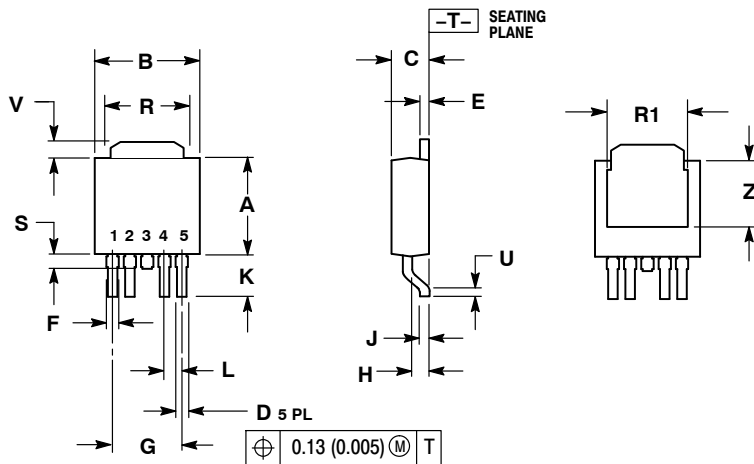

- NOTES:
1. DIMENSIONING AND TOLERANCING PER ANSI Y14.5M, 1982.
2. CONTROLLING DIMENSION: INCH.

DIM	INCHES		MILLIMETERS	
	MIN	MAX	MIN	MAX
A	0.235	0.245	5.97	6.22
B	0.250	0.265	6.35	6.73
C	0.086	0.094	2.19	2.38
D	0.020	0.028	0.51	0.71
E	0.018	0.023	0.46	0.58
F	0.024	0.032	0.61	0.81
G	0.180 BSC		4.56 BSC	
H	0.034	0.040	0.87	1.01
J	0.018	0.023	0.46	0.58
K	0.102	0.114	2.60	2.89
L	0.045 BSC		1.14 BSC	
R	0.170	0.190	4.32	4.83
R1	0.185	0.210	4.70	5.33
S	0.025	0.040	0.63	1.01
U	0.020	---	0.51	---
V	0.035	0.050	0.89	1.27
Z	0.155	0.170	3.93	4.32

RECOMMENDED
SOLDERING FOOTPRINT*

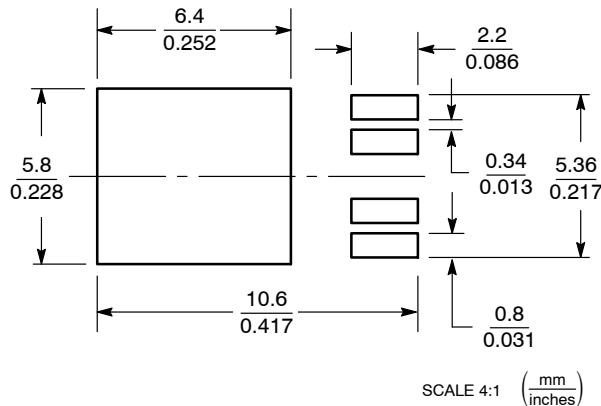

SCALE 4:1 (mm/inches)

GENERIC
MARKING DIAGRAMS*

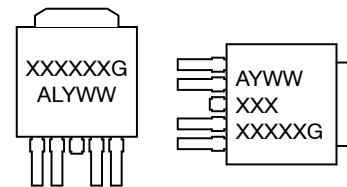

IC

Discrete

- XXXXXX = Device Code
- A = Assembly Location
- L = Wafer Lot
- Y = Year
- WW = Work Week
- G = Pb-Free Package

*For additional information on our Pb-Free strategy and soldering details, please download the onsemi Soldering and Mounting Techniques Reference Manual, [SOLDERRM/D](#).

*This information is generic. Please refer to device data sheet for actual part marking. Pb-Free indicator, "G" or microdot "▪", may or may not be present.

DOCUMENT NUMBER:	98AON12855D	Electronic versions are uncontrolled except when accessed directly from the Document Repository. Printed versions are uncontrolled except when stamped "CONTROLLED COPY" in red.
DESCRIPTION:	DPAK-5 CENTER LEAD CROP	PAGE 1 OF 1

onsemi and ONSEMI are trademarks of Semiconductor Components Industries, LLC dba onsemi or its subsidiaries in the United States and/or other countries. onsemi reserves the right to make changes without further notice to any products herein. onsemi makes no warranty, representation or guarantee regarding the suitability of its products for any particular purpose, nor does onsemi assume any liability arising out of the application or use of any product or circuit, and specifically disclaims any and all liability, including without limitation special, consequential or incidental damages. onsemi does not convey any license under its patent rights nor the rights of others.

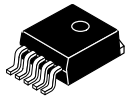

D²PAK 5-LEAD
CASE 936A-02
ISSUE E

DATE 28 JUL 2021

SCALE 1:1

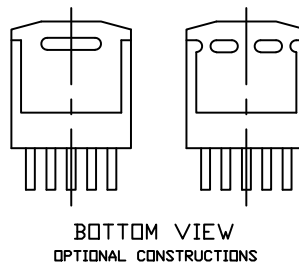
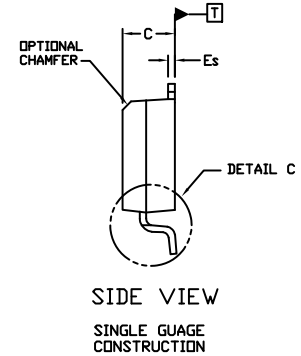
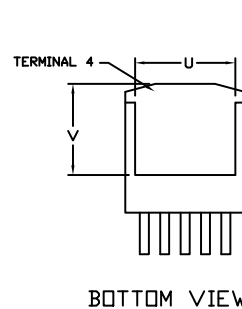
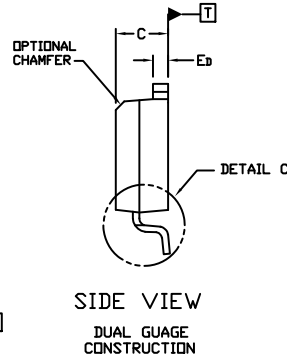
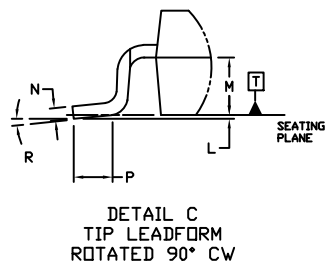
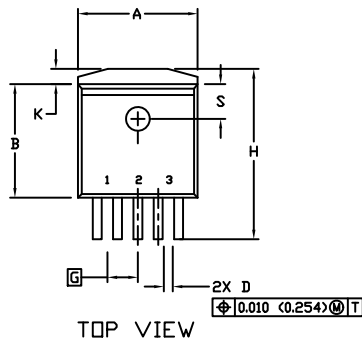

NOTES:

1. DIMENSIONING AND TOLERANCING PER ANSI Y14.5M, 1982.
2. CONTROLLING DIMENSION INCHES
3. TAB CONTOUR OPTIONAL WITHIN DIMENSIONS A AND K.
4. DIMENSIONS U AND V ESTABLISH A MINIMUM MOUNTING SURFACE FOR TERMINAL 4.
5. DIMENSIONS A AND B DO NOT INCLUDE MOLD FLASH OR GATE PROTRUSIONS. MOLD FLASH AND GATE PROTRUSIONS NOT TO EXCEED 0.025 (0.635) MAXIMUM.

DIM	INCHES		MILLIMETERS	
	MIN.	MAX.	MIN.	MAX.
A	0.396	0.403	9.804	10.236
B	0.356	0.368	9.042	9.347
C	0.170	0.180	4.318	4.572
D	0.026	0.036	0.660	0.914
Ed	0.045	0.055	1.143	1.397
Es	0.018	0.026	0.457	0.660
G	0.067	BSC	1.702	BSC
H	0.539	0.579	13.691	14.707
K	0.050	REF	1.270	REF
L	0.000	0.010	0.000	0.254
M	0.088	0.102	2.235	2.591
N	0.018	0.026	0.457	0.660
P	0.058	0.078	1.473	1.981
R	0°	8°	0°	8°
S	0.116	REF	2.946	REF
U	0.200	MIN	5.080	MIN
V	0.250	MIN	6.350	MIN

GENERIC MARKING DIAGRAM*

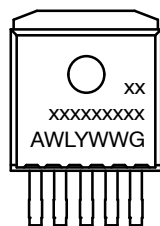

- xxxxxx = Device Code
- A = Assembly Location
- WL = Wafer Lot
- Y = Year
- WW = Work Week
- G = Pb-Free Package

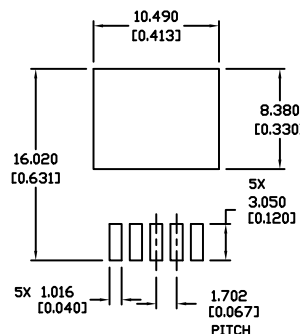

* For additional information on our Pb-Free strategy and soldering details, please download the ON Semiconductor Soldering and Mounting Techniques Reference Manual, SOLDERRM/D.

*This information is generic. Please refer to device data sheet for actual part marking. Pb-Free indicator, "G" or microdot "μ", may or may not be present. Some products may not follow the Generic Marking.

DOCUMENT NUMBER:	98ASH01006A	Electronic versions are uncontrolled except when accessed directly from the Document Repository. Printed versions are uncontrolled except when stamped "CONTROLLED COPY" in red.
DESCRIPTION:	D2PAK 5-LEAD	PAGE 1 OF 1

onsemi and ONSEMI are trademarks of Semiconductor Components Industries, LLC dba onsemi or its subsidiaries in the United States and/or other countries. onsemi reserves the right to make changes without further notice to any products herein. onsemi makes no warranty, representation or guarantee regarding the suitability of its products for any particular purpose, nor does onsemi assume any liability arising out of the application or use of any product or circuit, and specifically disclaims any and all liability, including without limitation special, consequential or incidental damages. onsemi does not convey any license under its patent rights nor the rights of others.

onsemi, **Onsemi**, and other names, marks, and brands are registered and/or common law trademarks of Semiconductor Components Industries, LLC dba "**onsemi**" or its affiliates and/or subsidiaries in the United States and/or other countries. **onsemi** owns the rights to a number of patents, trademarks, copyrights, trade secrets, and other intellectual property. A listing of **onsemi**'s product/patent coverage may be accessed at www.onsemi.com/site/pdf/Patent-Marking.pdf. **onsemi** reserves the right to make changes at any time to any products or information herein, without notice. The information herein is provided "as-is" and **onsemi** makes no warranty, representation or guarantee regarding the accuracy of the information, product features, availability, functionality, or suitability of its products for any particular purpose, nor does **onsemi** assume any liability arising out of the application or use of any product or circuit, and specifically disclaims any and all liability, including without limitation special, consequential or incidental damages. Buyer is responsible for its products and applications using **onsemi** products, including compliance with all laws, regulations and safety requirements or standards, regardless of any support or applications information provided by **onsemi**. "Typical" parameters which may be provided in **onsemi** data sheets and/or specifications can and do vary in different applications and actual performance may vary over time. All operating parameters, including "Typicals" must be validated for each customer application by customer's technical experts. **onsemi** does not convey any license under any of its intellectual property rights nor the rights of others. **onsemi** products are not designed, intended, or authorized for use as a critical component in life support systems or any FDA Class 3 medical devices or medical devices with a same or similar classification in a foreign jurisdiction or any devices intended for implantation in the human body. Should Buyer purchase or use **onsemi** products for any such unintended or unauthorized application, Buyer shall indemnify and hold **onsemi** and its officers, employees, subsidiaries, affiliates, and distributors harmless against all claims, costs, damages, and expenses, and reasonable attorney fees arising out of, directly or indirectly, any claim of personal injury or death associated with such unintended or unauthorized use, even if such claim alleges that **onsemi** was negligent regarding the design or manufacture of the part. **onsemi** is an Equal Opportunity/Affirmative Action Employer. This literature is subject to all applicable copyright laws and is not for resale in any manner.

ADDITIONAL INFORMATION

TECHNICAL PUBLICATIONS:

Technical Library: www.onsemi.com/design/resources/technical-documentation
onsemi Website: www.onsemi.com

ONLINE SUPPORT: www.onsemi.com/support

For additional information, please contact your local Sales Representative at www.onsemi.com/support/sales