

# NCV8669

## LDO Regulator - Very Low $I_q$ , Reset, Early Warning 150 mA

The NCV8669 is 150 mA LDO regulator with integrated reset and early warning functions dedicated for microprocessor applications. Its robustness allows NCV8669 to be used in severe automotive environments. The NCV8669 utilizes precise 1 M $\Omega$  internal resistor divider for Early Warning function which significantly reduces overall application quiescent current and number of external components. Very low quiescent current as low as 42  $\mu$ A typical for NCV8669 makes it suitable for applications permanently connected to battery requiring very low quiescent current with or without load. The NCV8669 contains protection functions as current limit and thermal shutdown.

### Features

- Output Voltage Options: 5 V
- Output Voltage Accuracy:  $\pm 2\%$
- Output Current up to 150 mA
- Very Low Quiescent Current: Typ 42  $\mu$ A (Including Internal Early Warning Resistor Divider Current)
- Very Low Dropout Voltage
- Early Warning Threshold Accuracy:  $\pm 10\%$  Over Temperature Range (Using  $R_{SI\_ext}$  External Resistor with  $\pm 1\%$  100 ppm/ $^{\circ}$ C)
- Microprocessor Compatible Control Functions:
  - ◆ Reset with Adjustable Power-on Delay
  - ◆ Early Warning
- Wide input voltage operation range: up to 40 V
- Protection Features:
  - ◆ Current Limitation
  - ◆ Thermal Shutdown
- These are Pb-Free Devices

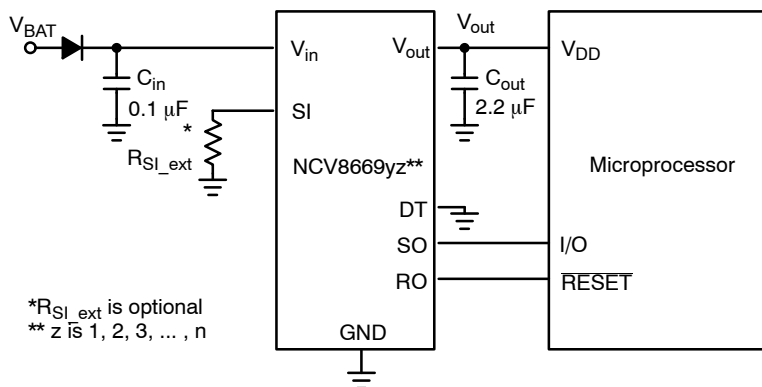
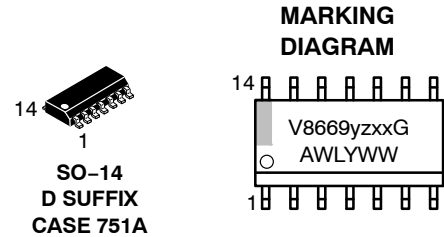

Figure 1. Application Circuit



ON Semiconductor®

<http://onsemi.com>



- y = Timing and Reset Threshold Option\*
- z = Early Warning Option\*
- xx = Voltage Option  
5.0 V (xx = 50)
- A = Assembly Location
- WL = Wafer Lot
- Y = Year
- WW = Work Week
- G = Pb-Free Package

\*See APPLICATION INFORMATION section.

### ORDERING INFORMATION

See detailed ordering and shipping information in the dimensions section on page 13 of this data sheet.

### Typical Applications

- Body Control Module
- Instruments and Clusters
- Occupant Protection and Comfort
- Powertrain

# NCV8669

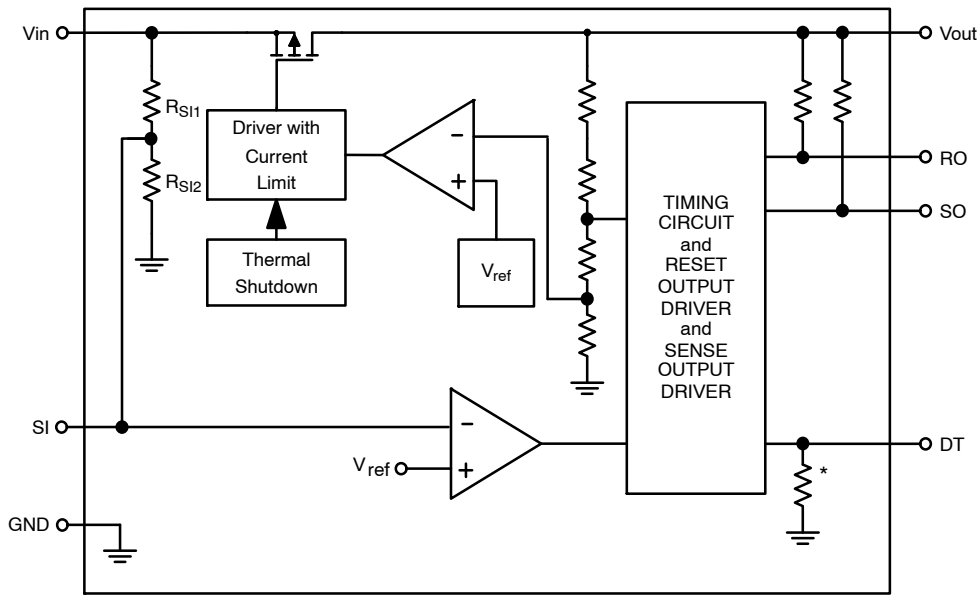

\*Pull-down Resistor (typ 150 kΩ) active only in Reset State.

**Figure 2. Simplified Block Diagram**

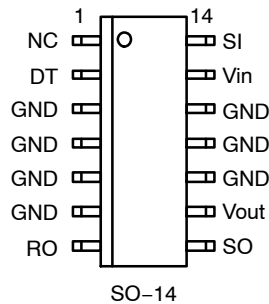

**Figure 3. Pin Connections**  
(Top View)

## PIN FUNCTION DESCRIPTION

Pin No. SO-14	Pin Name	Description
1	NC	Not Connected.
2	DT	Reset Delay Time Select. Short to GND or connect to $V_{out}$ to select time.
3, 4, 5, 6, 10, 11, 12	GND	Power Supply Ground.
7	RO	Reset Output. 30 kΩ internal Pull-Up resistor connected to $V_{out}$ . RO goes Low when $V_{out}$ drops by more than 7% (typ.) from its nominal value.
8	SO	Early Warning Output. 30 kΩ internal Pull-Up resistor connected to $V_{out}$ . It can be used to provide early warning of an impending reset condition. Leave open if not used.
9	$V_{out}$	Regulated Output Voltage. Connect 2.2 μF capacitor with ESR < 100 Ω to ground.
13	$V_{in}$	Positive Power Supply Input. Connect 0.1 μF capacitor to ground.
14	SI	Early Warning Adjust Input; connect $R_{SI\_ext}$ against GND to adjust Input Voltage Early Warning Threshold or leave unconnected. See Electrical Characteristics Table and Application Information sections for more information.

**ABSOLUTE MAXIMUM RATINGS**

Rating	Symbol	Min	Max	Unit
Input Voltage DC (Note 1) DC Transient, t < 100 ms	V <sub>in</sub>	-0.3 -	40 45	V
Input Current	I <sub>in</sub>	-5	-	mA
Output Voltage (Note 2)	V <sub>out</sub>	-0.3	5.5	V
Output Current	I <sub>out</sub>	-3	Current Limited	mA
Sense Input Voltage DC DC Transient, t < 100 ms	V <sub>SI</sub>	-0.3 -	40 45	V
Sense Input Current Range	I <sub>SI</sub>	-1	1	mA
DT (Reset Delay Time Select) Voltage	V <sub>DT</sub>	-0.3	5.5	V
DT (Reset Delay Time Select) Current	I <sub>DT</sub>	-1	1	mA
Reset Output Voltage	V <sub>RO</sub>	-0.3	5.5	V
Reset Output Current	I <sub>RO</sub>	-3	3	mA
Sense Output Voltage	V <sub>SO</sub>	-0.3	5.5	V
Sense Output Current	I <sub>SO</sub>	-3	3	mA
Junction Temperature	T <sub>J</sub>	-40	150	°C
Storage Temperature	T <sub>STG</sub>	-55	150	°C

Stresses exceeding Maximum Ratings may damage the device. Maximum Ratings are stress ratings only. Functional operation above the Recommended Operating Conditions is not implied. Extended exposure to stresses above the Recommended Operating Conditions may affect device reliability.

1. Refer to ELECTRICAL CHARACTERISTICS and APPLICATION INFORMATION for Safe Operating Area.
2. 5.5 or (V<sub>in</sub> + 0.3 V), whichever is lower

**ESD CAPABILITY (Note 3)**

Rating	Symbol	Min	Max	Unit
ESD Capability, Human Body Model	ESD <sub>HBM</sub>	-2	2	kV
ESD Capability, Machine Model	ESD <sub>MM</sub>	-200	200	V
ESD Capability, Charged Device Model	ESD <sub>CDM</sub>	-1	1	kV

3. This device series incorporates ESD protection and is tested by the following methods:  
ESD Human Body Model tested per AEC-Q100-002 (JESD-001-2010)  
ESD Machine Model tested per AEC-Q100-003 (EIA/JESD22-A115)  
ESD Charged Device Model tested per AEC-Q100-011 (EIA/JESD22-C101)

**LEAD SOLDERING TEMPERATURE AND MSL (Note 4)**

Rating	Symbol	Min	Max	Unit
Moisture Sensitivity Level	MSL		1	-
Lead Temperature Soldering Reflow (SMD Styles Only), Pb-Free Versions	T <sub>SLD</sub>	-	265 peak	°C

4. For more information, please refer to our Soldering and Mounting Techniques Reference Manual, SOLDERRM/D

**THERMAL CHARACTERISTICS (Note 5)**

Rating	Symbol	Value	Unit
Thermal Characteristics Thermal Resistance, Junction-to-Air (Note 6) Thermal Reference, Junction-to-Lead (Note 6)	R <sub>θJA</sub> R <sub>ψJL</sub>	94 18	°C/W

5. Refer to ELECTRICAL CHARACTERISTICS and APPLICATION INFORMATION for Safe Operating Area.
6. Values based on copper area of 645 mm<sup>2</sup> (or 1 in<sup>2</sup>) of 1 oz copper thickness and FR4 PCB substrate.

# NCV8669

## OPERATING RANGES (Note 7)

Rating	Symbol	Min	Max	Unit
Input Voltage (Note 7)	$V_{in}$	5.5	40	V
Junction Temperature	$T_J$	-40	150	°C

7. Refer to ELECTRICAL CHARACTERISTICS and APPLICATION INFORMATION for Safe Operating Area.

8. Minimum  $V_{in} = 5.5$  V or ( $V_{out} + V_{DO}$ ), whichever is higher.

**ELECTRICAL CHARACTERISTICS**  $V_{in} = 13.2$  V,  $V_{DT} = GND$ ,  $R_{SI\_ext}$  not used,  $C_{in} = 0.1$   $\mu$ F,  $C_{out} = 2.2$   $\mu$ F, for typical values  $T_J = 25^\circ$ C, for min/max values  $T_J = -40^\circ$ C to  $150^\circ$ C; unless otherwise noted. (Notes 9 and 10)

Parameter	Test Conditions	Symbol	Min	Typ	Max	Unit
-----------	-----------------	--------	-----	-----	-----	------

### REGULATOR OUTPUT

Output Voltage (Accuracy %)	$V_{in} = 5.6$ V to 40 V, $I_{out} = 0.1$ mA to 100 mA $V_{in} = 5.8$ V to 16 V, $I_{out} = 0.1$ mA to 150 mA	$V_{out}$	4.9 4.9 (-2%)	5.0 5.0	5.1 5.1 (+2%)	V
Output Voltage (Accuracy %)	$T_J = -40$ °C to $125$ °C $V_{in} = 5.8$ V to 28 V, $I_{out} = 0$ mA to 150 mA	$V_{out}$	4.9 (-2%)	5.0	5.1 (+2%)	V
Line Regulation	$V_{in} = 6$ V to 28 V, $I_{out} = 5$ mA	$Reg_{line}$	-20	0	20	mV
Load Regulation	$I_{out} = 0.1$ mA to 150 mA	$Reg_{load}$	-40	10	40	mV
Dropout Voltage (Note 11)	$I_{out} = 100$ mA $I_{out} = 150$ mA	$V_{DO}$	-	225 300	450 600	mV
Output Capacitor for Stability (Note 12)	$I_{out} = 0$ mA to 150 mA	$C_{out}$ ESR	2.2 0.01	- -	100 100	$\mu$ F $\Omega$

### QUIESCENT CURRENT

Quiescent Current, $I_q = I_{in} - I_{out}$ (Note 13)	$I_{out} = 0.1$ mA, $T_J = 25^\circ$ C $I_{out} = 0.1$ mA to 150 mA, $T_J \leq 125^\circ$ C	$I_q$	- -	42	49 50	$\mu$ A
---	--	-------	--------	----	----------	---------

### CURRENT LIMIT PROTECTION

Current Limit	$V_{out} = 0.96 \times V_{out\_nom}$	$I_{LIM}$	205	-	525	mA
Short Circuit Current Limit	$V_{out} = 0$ V	$I_{SC}$	205	-	525	mA

### PSRR

Power Supply Ripple Rejection (Note 12)	$f = 100$ Hz, $0.5 V_{pp}$	PSRR	-	60	-	dB
---	----------------------------	------	---	----	---	----

### DT (Reset Delay Time Select)

DT Threshold Voltage Logic Low Logic High		$V_{th(DT)}$	- 2	- -	0.8 -	V
DT Input Current	$V_{DT} = 5$ V	$I_{DT}$	-	-	1	$\mu$ A

### RESET OUTPUT RO

Output Voltage Reset Threshold (Note 14)	$V_{out}$ decreasing $V_{in} > 5.5$ V	$V_{RT}$	90	93	96	% $V_{out}$
Reset Hysteresis		$V_{RH}$	-	2.0	-	% $V_{out}$
Maximum Reset Sink Current	$V_{out} = 4.5$ V, $V_{RO} = 0.25$ V	$I_{ROmax}$	1.75	-	-	mA

9. Refer to ABSOLUTE MAXIMUM RATINGS and APPLICATION INFORMATION for Safe Operating Area.

10. Performance guaranteed over the indicated operating temperature range by design and/or characterization tested at  $T_A \approx T_J$ . Low duty cycle pulse techniques are used during testing to maintain the junction temperature as close to ambient as possible.

11. Measured when output voltage falls 100 mV below the regulated voltage at  $V_{in} = 13.2$  V.

12. Values based on design and/or characterization.

13.  $I_q$  for Preset EW Threshold Options is measured when  $R_{SI\_ext}$  is not used. For typical values of  $I_q$  vs  $R_{SI\_ext}$  see Figure 23.

14. See APPLICATION INFORMATION section for Reset Thresholds and Reset Delay Time Options

# NCV8669

**ELECTRICAL CHARACTERISTICS**  $V_{in} = 13.2\text{ V}$ ,  $V_{DT} = \text{GND}$ ,  $R_{SI\_ext}$  not used,  $C_{in} = 0.1\ \mu\text{F}$ ,  $C_{out} = 2.2\ \mu\text{F}$ , for typical values  $T_J = 25^\circ\text{C}$ , for min/max values  $T_J = -40^\circ\text{C}$  to  $150^\circ\text{C}$ ; unless otherwise noted. (Notes 9 and 10)

Parameter	Test Conditions	Symbol	Min	Typ	Max	Unit
-----------	-----------------	--------	-----	-----	-----	------

## RESET OUTPUT RO

Reset Output Low Voltage	$V_{out} > 1\text{ V}$ , $I_{RO} < 200\ \mu\text{A}$	$V_{ROL}$	-	0.15	0.25	V
Reset Output High Voltage		$V_{ROH}$	4.5	-	-	V
Integrated Reset Pull Up Resistor		$R_{RO}$	15	30	50	k $\Omega$
Reset Delay Time (Note 14)	DT connected to GND DT connected to $V_{out}$	$t_{RD}$	12.8 25.6	16 32	19.2 38.4	ms
Reset Reaction Time (see Figure 24)		$t_{RR}$	16	25	38	$\mu\text{s}$

## EARLY WARNING (SI and SO)

Early Warning Input Voltage Threshold (Preset EW Threshold Values) NCV8669y2 High Low	$R_{SI1} = 480\ \text{k}\Omega$ , $R_{SI2} = 520\ \text{k}\Omega$ (internal resistor divider values, see ) $R_{SI\_ext} = 150\ \text{k}\Omega$ ( $\pm 1\%$ , $\pm 100\ \text{ppm}/^\circ\text{C}$ ) (external resistor value, see Figure 22)	$V_{in\_EW(th)}$				V
			5.67 5.30	6.30 5.89	6.92 6.47	
Integrated Sense Output Pull Up Resistor		$R_{SO}$	15	30	50	k $\Omega$
Sense Output Low Voltage	$V_{in} < V_{in\_EW(th)\_Low\_Min}$ , $I_{SO} < 200\ \mu\text{A}$ , $V_{out} > 1\text{ V}$	$V_{SOL}$	-	0.15	0.25	V
Sense Output High Voltage		$V_{SOH}$	4.5	-	-	V
Maximum Sense Output Sink Current	$V_{SO} = 0.25\text{ V}$ $V_{in} < V_{in\_EW(th)\_Low\_Min}$ $V_{out} = 4.5\text{ V}$	$I_{SOmax}$	1.75	-	-	mA

## THERMAL SHUTDOWN

Thermal Shutdown Temperature (Note 12)		$T_{SD}$	150	175	195	$^\circ\text{C}$
Thermal Shutdown Hysteresis (Note 12)		$T_{SH}$	-	25	-	$^\circ\text{C}$

9. Refer to ABSOLUTE MAXIMUM RATINGS and APPLICATION INFORMATION for Safe Operating Area.
10. Performance guaranteed over the indicated operating temperature range by design and/or characterization tested at  $T_A \approx T_J$ . Low duty cycle pulse techniques are used during testing to maintain the junction temperature as close to ambient as possible.
11. Measured when output voltage falls 100 mV below the regulated voltage at  $V_{in} = 13.2\text{ V}$ .
12. Values based on design and/or characterization.
13.  $I_q$  for Preset EW Threshold Options is measured when  $R_{SI\_ext}$  is not used. For typical values of  $I_q$  vs  $R_{SI\_ext}$  see Figure 23.
14. See APPLICATION INFORMATION section for Reset Thresholds and Reset Delay Time Options

TYPICAL CHARACTERISTICS

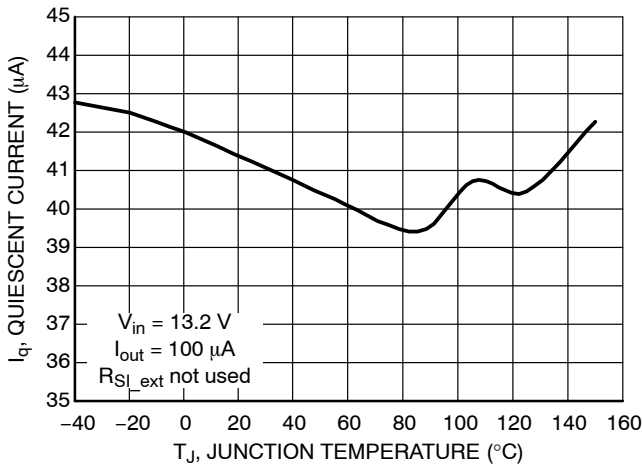

Figure 4. Quiescent Current vs. Temperature

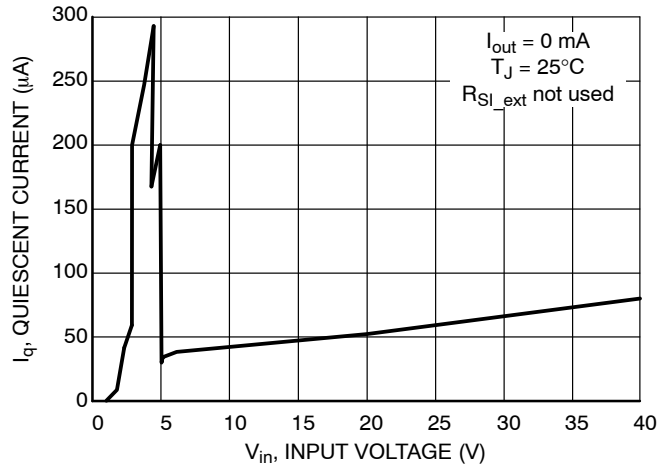

Figure 5. Quiescent Current vs. Input Voltage

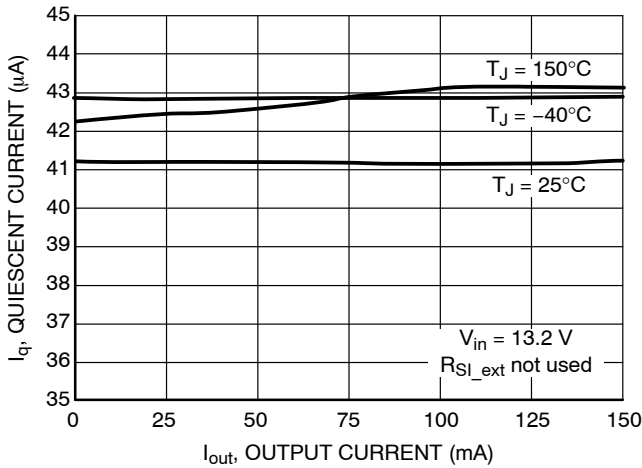

Figure 6. Quiescent Current vs. Output Current

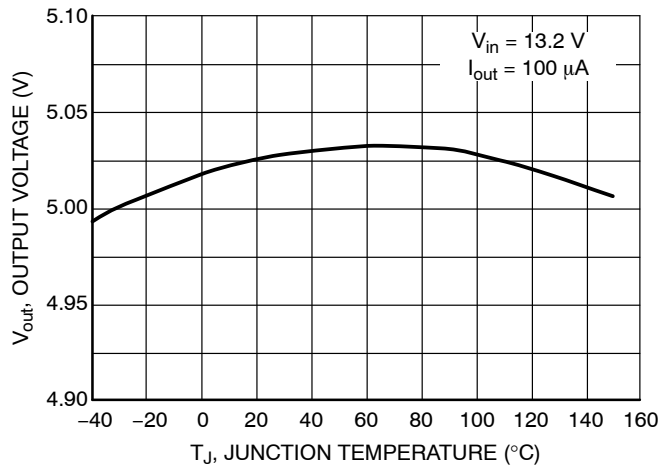

Figure 7. Output Voltage vs. Temperature

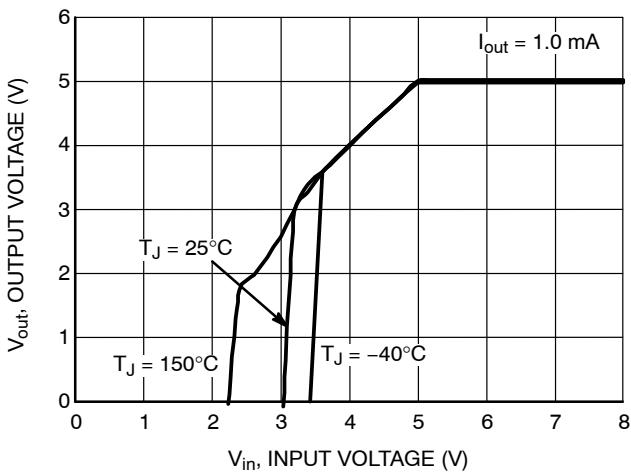

Figure 8. Output Voltage vs. Input Voltage

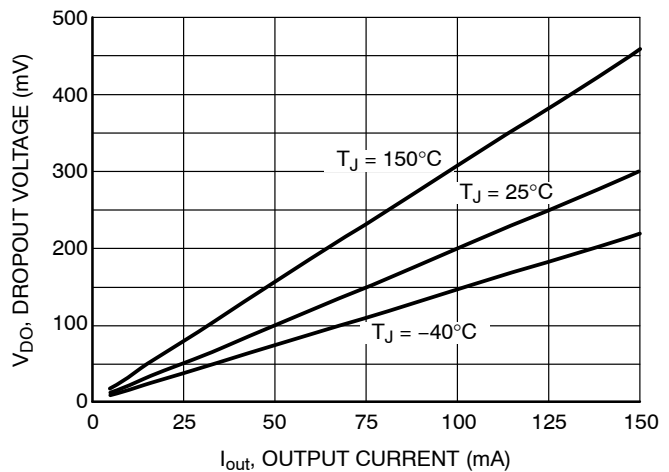

Figure 9. Dropout vs. Output Current

TYPICAL CHARACTERISTICS

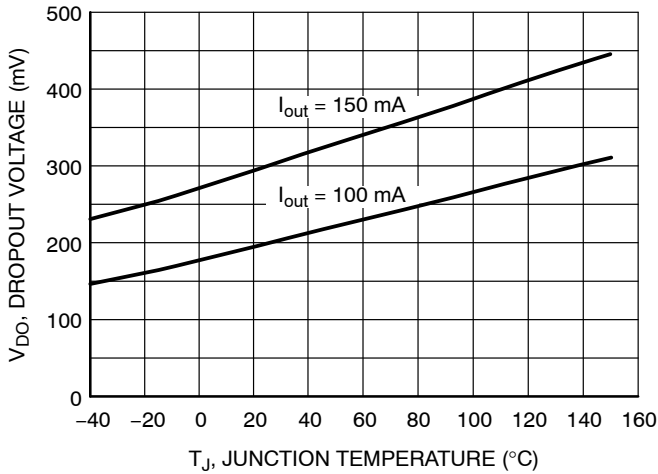

Figure 10. Dropout vs. Temperature

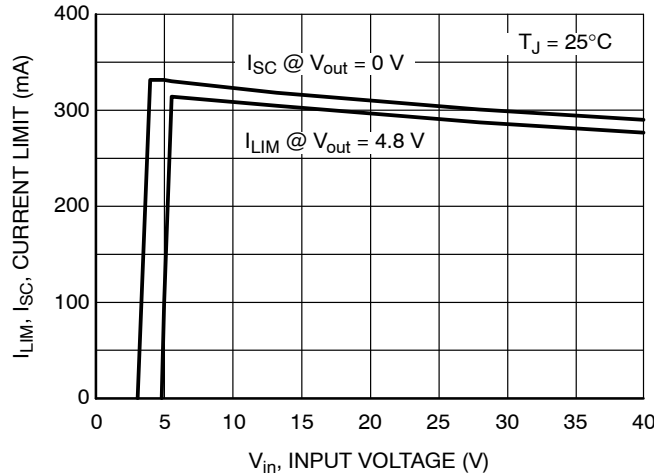

Figure 11. Output Current Limit vs. Input Voltage

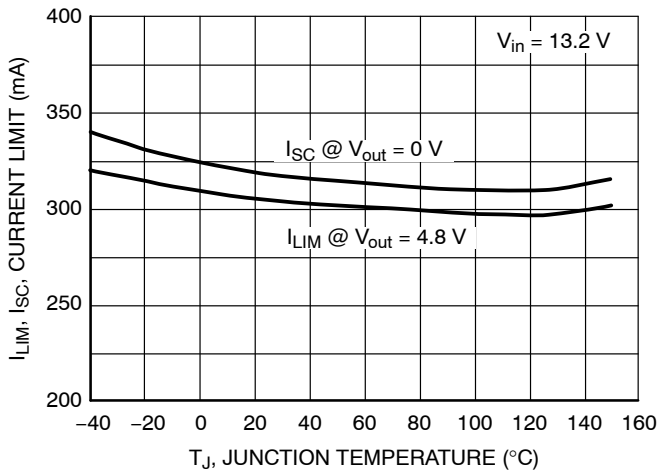

Figure 12. Output Current Limit vs. Temperature

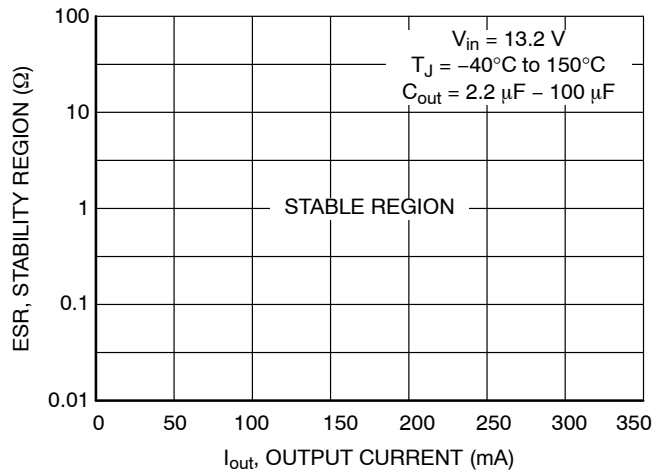

Figure 13. C<sub>out</sub> ESR Stability vs. Output Current

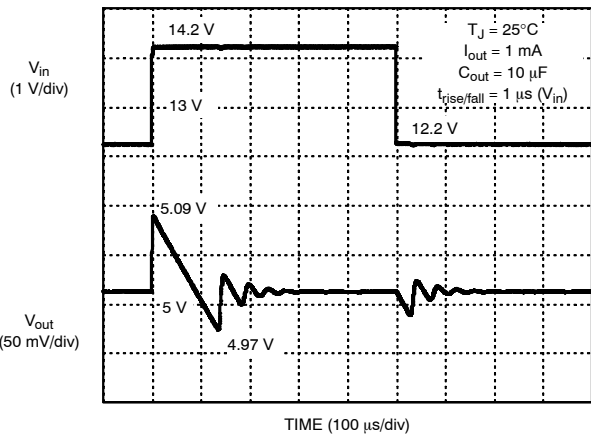

Figure 14. Line Transients

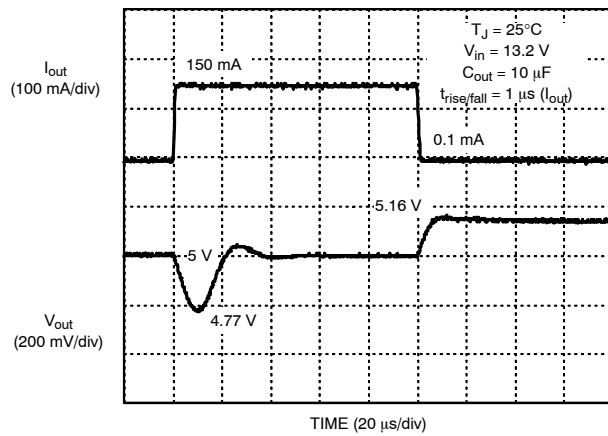

Figure 15. Load Transients

TYPICAL CHARACTERISTICS

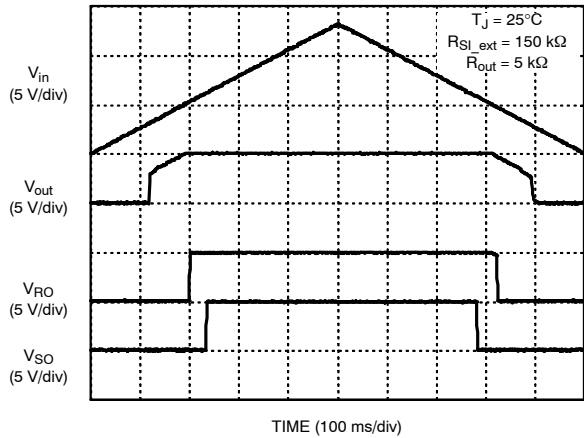

Figure 16. Power Up and Down Transient

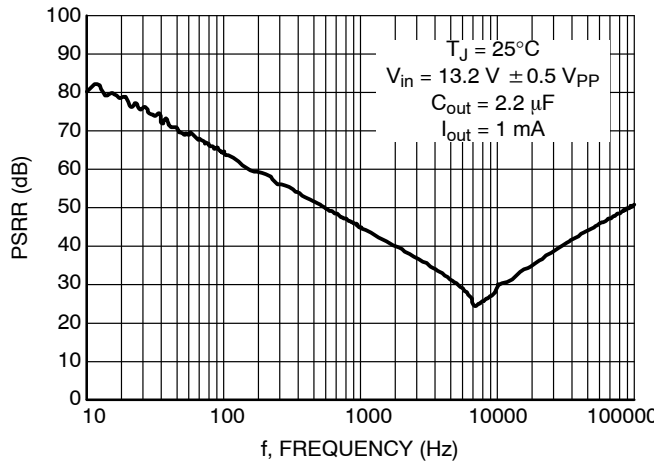

Figure 17. PSRR vs. Frequency

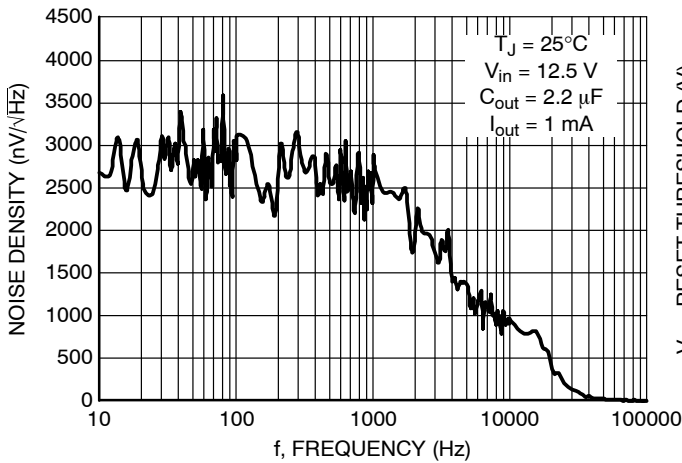

Figure 18. Noise Density vs. Frequency

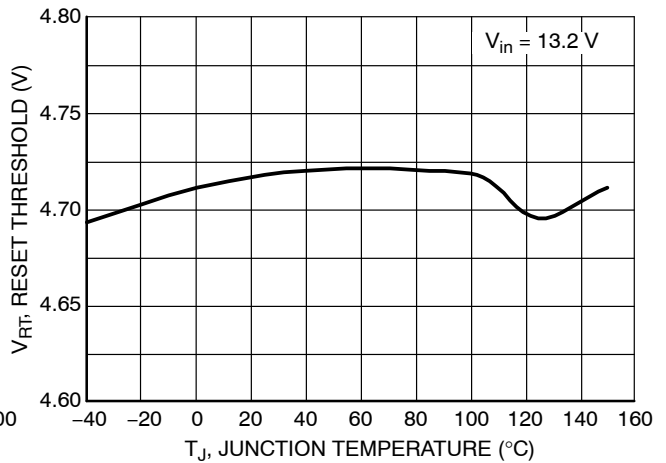

Figure 19. Reset Threshold vs. Temperature

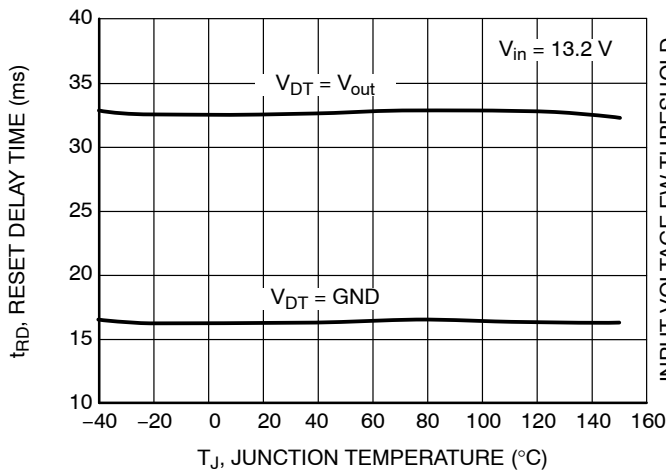

Figure 20. Reset Delay Times vs. Temperature

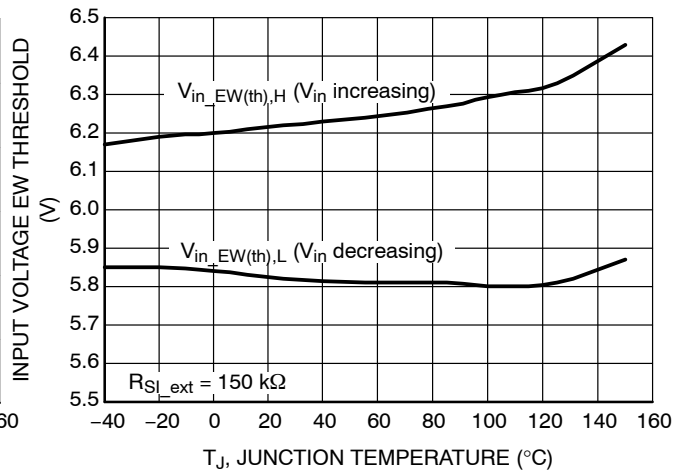

Figure 21. Vin EW Thresholds vs. Temperature



TYPICAL CHARACTERISTICS

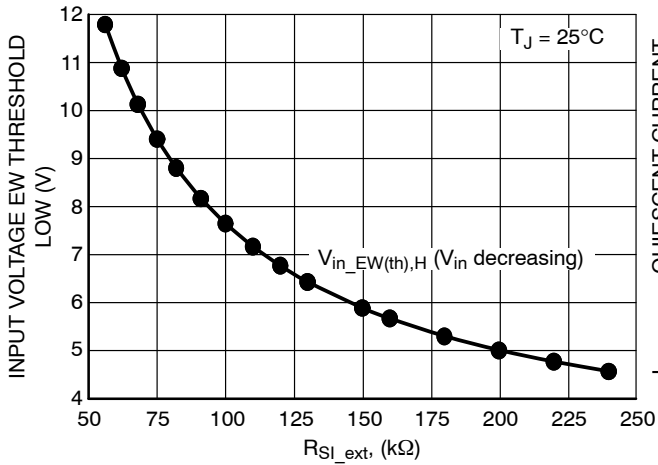

Figure 22. Input Voltage EW Threshold Low vs.  $R_{Sl\_ext}$  (Calculated Using E24 Series)

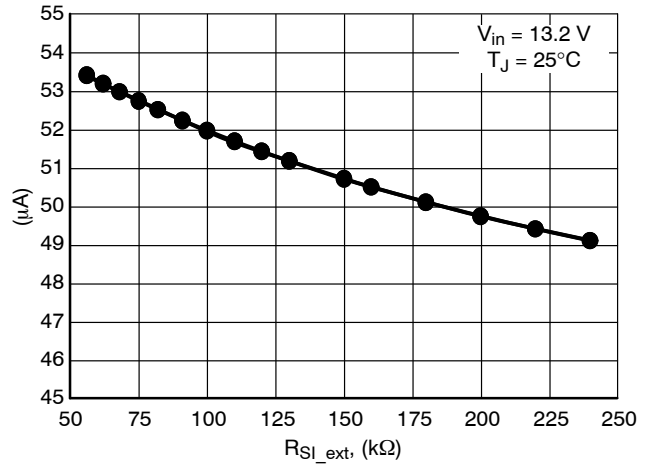

Figure 23. Quiescent Current vs.  $R_{Sl\_ext}$  (Including  $I_{RSl\_ext}$ , Calculated Using E24 Series)

# NCV8669

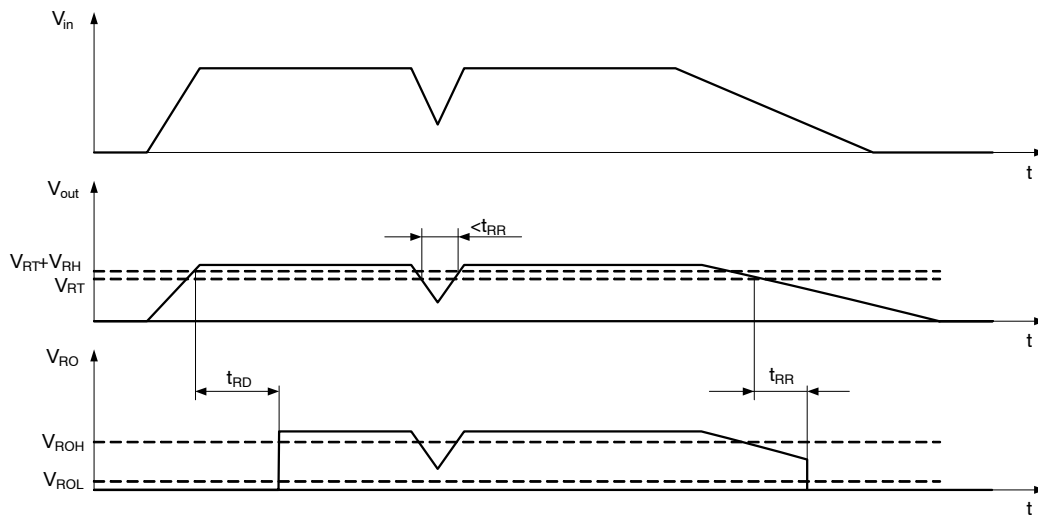

Figure 24. Reset Function and Timing Diagram

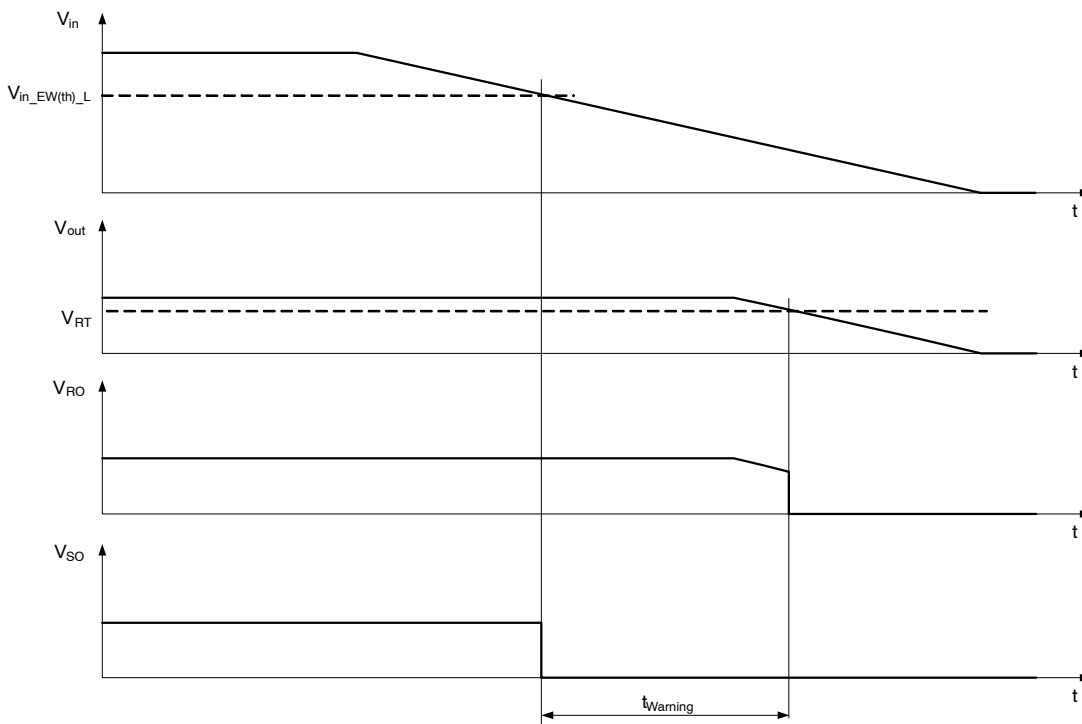

Figure 25. Input Voltage Early Warning Function Diagram

## DEFINITIONS

### General

All measurements are performed using short pulse low duty cycle techniques to maintain junction temperature as close as possible to ambient temperature.

### Output Voltage

The output voltage parameter is defined for specific temperature, input voltage and output current values or specified over Line, Load and Temperature ranges.

### Line Regulation

The change in output voltage for a change in input voltage measured for specific output current over operating ambient temperature range.

### Load Regulation

The change in output voltage for a change in output current measured for specific input voltage over operating ambient temperature range.

**Dropout Voltage**

The input to output differential at which the regulator output no longer maintains regulation against further reductions in input voltage. It is measured when the output drops 100 mV below its nominal value. The junction temperature, load current, and minimum input supply requirements affect the dropout level.

**Quiescent Current**

Quiescent Current ( $I_q$ ) is the difference between the input current (measured through the LDO input pin) and the output load current.

**Current Limit and Short Circuit Current Limit**

Current Limit is value of output current by which output voltage drops below 96% of its nominal value. It means that the device is capable to supply minimum 200 mA without sending Reset signal to microprocessor.

Short Circuit Current Limit is output current value measured with output of the regulator shorted to ground.

**PSRR**

Power Supply Rejection Ratio is defined as ratio of output voltage and input voltage ripple. It is measured in decibels (dB).

**Line Transient Response**

Typical output voltage overshoot and undershoot response when the input voltage is excited with a given slope.

**Load Transient Response**

Typical output voltage overshoot and undershoot response when the output current is excited with a given slope between low-load and high-load conditions.

**Thermal Protection**

Internal thermal shutdown circuitry is provided to protect the integrated circuit in the event that the maximum junction temperature is exceeded. When activated at typically 175°C, the regulator turns off. This feature is provided to prevent failures from accidental overheating.

**Maximum Package Power Dissipation**

The power dissipation level is maximum allowed power dissipation for particular package or power dissipation at which the junction temperature reaches its maximum operating value, whichever is lower.

**APPLICATIONS INFORMATION**

The NCV8669 regulator is self-protected with internal thermal shutdown and internal current limit. Typical characteristics are shown in Figures 4 to 25.

**Input Decoupling ( $C_{in}$ )**

A ceramic or tantalum 0.1  $\mu$ F capacitor is recommended and should be connected close to the NCV8669 package. Higher capacitance and lower ESR will improve the overall line and load transient response.

If extremely fast input voltage transients are expected then appropriate input filter must be used in order to decrease rising and/or falling edges below 50 V/ $\mu$ s for proper operation. The filter can be composed of several capacitors in parallel.

**Output Decoupling ( $C_{out}$ )**

The NCV8669 is a stable component and does not require a minimum Equivalent Series Resistance (ESR) for the output capacitor. Stability region of ESR versus Output Current is shown in Figure 13. The minimum output decoupling value is 2.2  $\mu$ F and can be augmented to fulfill stringent load transient requirements. The regulator works with ceramic chip capacitors as well as tantalum devices. Larger values improve noise rejection and load transient response.

**Reset Delay Time Select**

Selection of the NCV8669yz devices and the state of the DT pin determines the available Reset Delay times. The part is designed for use with DT tied to ground or OUT, but may be controlled by any logic signal which provides a threshold

between 0.8 V and 2 V. The default condition for an open DT pin is the faster Reset time (DT = GND condition). Times are in pairs and are highlighted in the table below. Consult factory for availability. The Delay Time select (DT) pin is logic level controlled and provides Reset Delay time per the table. Note the DT pin is sampled only when RO is low, and changes to the DT pin when RO is high will not effect the reset delay time.

**Reset Operation**

A reset signal is provided on the Reset Output (RO) pin to provide feedback to the microprocessor of an out of regulation condition. The timing diagram of reset function is shown in Figure 24. This is in the form of a logic signal on RO. Output voltage conditions below the RESET threshold cause RO to go low. The RO integrity is maintained down to  $V_{out} = 1.0$  V. The Reset Output (RO) circuitry includes internal pull-up connected to the output ( $V_{out}$ ) No external pull-up is necessary.

**RESET DELAY AND RESET THRESHOLD OPTIONS**

Part Number	DT = GND Reset Time	DT = $V_{out}$ Reset Time	Reset Threshold
NCV86695z	16 ms	32 ms	93%

NOTE: The timing values can be selected from following list: 8, 16, 32, 64, and 128 ms. The reset threshold values can be selected from following list: 90% and 93%. Contact factory for other timing and reset thresholds combinations not included in the table.

**Sense Input (SI) / Sense Output (SO) Voltage Monitor**

An on-chip comparator is available to provide early warning to the microprocessor of a possible reset signal (Figure 25). The Sense Output is from an open drain driver with an internal 30 kΩ pull up resistor to V<sub>out</sub>. The reset signal typically turns the microprocessor off instantaneously. This can cause unpredictable results with the microprocessor. The signal received from the SO pin will allow the microprocessor time (t<sub>Warning</sub>) to complete its present task before shutting down. The actual trip point of input voltage is programmed by internal resistor divider and external resistor R<sub>SI\_ext</sub>. If R<sub>SI\_ext</sub> is not used following Preset Early Warning Threshold would apply:

**EARLY WARNING PRESET OPTIONS**

Part Number	R <sub>SI1</sub> (Internal)	R <sub>SI2</sub> (Internal)	Input Voltage Early Warning Threshold Low (Typ) (R <sub>SI_ext</sub> not used)
NCV8669y2	480 kΩ	520 kΩ	2.37 V

NOTE: Contact factory for other EW Preset Options combinations not included in the table.

Practically only preset options above 4.5 V can be used without R<sub>SI\_ext</sub> due to minimum operating input voltage value limitation. For other preset options the trip point has to be adjusted externally using R<sub>SI\_ext</sub> resistor connected between input monitor SI and GND (see Figure 1). For other preset options R<sub>SI\_ext</sub> has to be used to achieve V<sub>in\_EW(th)</sub> > 5.5 V (minimum operating input voltage value). The value for R<sub>SI\_ext</sub> is recommended to be selected in range from 50 kΩ to 250 kΩ and the trip point can be shifted according to Figure 22. The higher is R<sub>SI\_ext</sub> the lower is overall Quiescent Current of the application (see Figure 23). General formulas for calculation of V<sub>in\_EW(th)Low</sub> or R<sub>SI\_ext</sub> for selected preset Early Warning options are described by Equations 1 and 2.

$$V_{in\_EW(th)\_Low} = 1.1 \left[ 1 + \frac{R_{SI1} \times (R_{SI2} + R_{SI\_ext})}{R_{SI2} \times R_{SI\_ext}} \right] + 0.25 \quad (eq. 1)$$

$$R_{SI\_ext} = 1.1 \left[ \frac{R_{SI1} \times R_{SI2}}{R_{SI2} \times (V_{in\_EW(th)\_Low} - 0.25) - 1.1 \times 10^6} \right] \quad (eq. 2)$$

Where:

- R<sub>SI1</sub>, R<sub>SI2</sub> – internal EW divider resistors (see Figure 2) (select values from Early Warning Preset Options table)
- R<sub>SI\_ext</sub> – external resistor connected between SI and GND (recommended to be selected from 50 kΩ to 250 kΩ)

**Thermal Considerations**

As power in the NCV8669 increases, it might become necessary to provide some thermal relief. The maximum power dissipation supported by the device is dependent upon board design and layout. Mounting pad configuration on the PCB, the board material, and the ambient temperature affect the rate of junction temperature rise for the part. When the NCV8669 has good thermal conductivity through the PCB, the junction temperature will be relatively low with high power applications. The maximum dissipation the NCV8669 can handle is given by:

$$P_{D(MAX)} = \frac{[T_{J(MAX)} - T_A]}{R_{\theta JA}} \quad (eq. 3)$$

Since T<sub>J</sub> is not recommended to exceed 150°C, then the NCV8669 soldered on 645 mm<sup>2</sup>, 1 oz copper area, FR4 can dissipate up to 1.33 W when the ambient temperature (T<sub>A</sub>) is 25°C. See Figure 26 for R<sub>thJA</sub> versus PCB area. The power dissipated by the NCV8669 can be calculated from the following equations:

$$P_D \approx V_{in}(I_q @ I_{out}) + I_{out}(V_{in} - V_{out}) \quad (eq. 4)$$

or

$$V_{in(MAX)} \approx \frac{P_{D(MAX)} + (V_{out} \times I_{out})}{I_{out} + I_q} \quad (eq. 5)$$

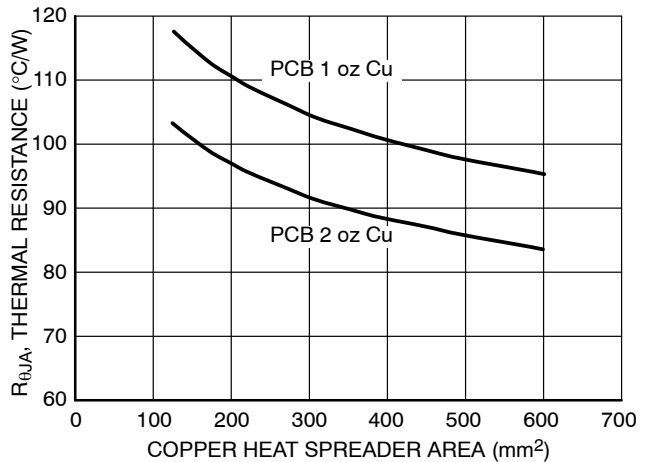

**Figure 26. Thermal Resistance vs. PCB Copper Area**

**Hints**

V<sub>in</sub> and GND printed circuit board traces should be as wide as possible. When the impedance of these traces is high, there is a chance to pick up noise or cause the regulator to malfunction. Place external components, especially the output capacitor, as close as possible to the NCV8669 and make traces as short as possible.

# NCV8669

## ORDERING INFORMATION

Device	Output Voltage	Reset Delay Time DT = GND/V <sub>out</sub>	Reset Threshold (Typ)	Input Voltage Early Warning Threshold Low (Typ) R <sub>SI_ext</sub> = 150 k $\Omega$	Marking	Package	Shipping†
NCV866952D250R2G	5.0 V	16 / 32 ms	93%	5.89 V	V86695250G	SO-14 (Pb-Free)	2500 / Tape & Reel

†For information on tape and reel specifications, including part orientation and tape sizes, please refer to our Tape and Reel Packaging Specifications Brochure, BRD8011/D

# MECHANICAL CASE OUTLINE PACKAGE DIMENSIONS



SCALE 1:1

SOIC-14 NB  
CASE 751A-03  
ISSUE L

DATE 03 FEB 2016

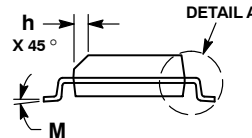

- NOTES:
1. DIMENSIONING AND TOLERANCING PER ASME Y14.5M, 1994.
  2. CONTROLLING DIMENSION: MILLIMETERS.
  3. DIMENSION b DOES NOT INCLUDE DAMBAR PROTRUSION. ALLOWABLE PROTRUSION SHALL BE 0.13 TOTAL IN EXCESS OF AT MAXIMUM MATERIAL CONDITION.
  4. DIMENSIONS D AND E DO NOT INCLUDE MOLD PROTRUSIONS.
  5. MAXIMUM MOLD PROTRUSION 0.15 PER SIDE.

DIM	MILLIMETERS		INCHES	
	MIN	MAX	MIN	MAX
A	1.35	1.75	0.054	0.068
A1	0.10	0.25	0.004	0.010
A3	0.19	0.25	0.008	0.010
b	0.35	0.49	0.014	0.019
D	8.55	8.75	0.337	0.344
E	3.80	4.00	0.150	0.157
e	1.27 BSC		0.050 BSC	
H	5.80	6.20	0.228	0.244
h	0.25	0.50	0.010	0.019
L	0.40	1.25	0.016	0.049
M	0°	7°	0°	7°

### SOLDERING FOOTPRINT\*



DIMENSIONS: MILLIMETERS

\*For additional information on our Pb-Free strategy and soldering details, please download the ON Semiconductor Soldering and Mounting Techniques Reference Manual, SOLDERRM/D.

### GENERIC MARKING DIAGRAM\*



- XXXXXX = Specific Device Code
- A = Assembly Location
- WL = Wafer Lot
- Y = Year
- WW = Work Week
- G = Pb-Free Package

\*This information is generic. Please refer to device data sheet for actual part marking. Pb-Free indicator, "G" or microdot "▪", may or may not be present. Some products may not follow the Generic Marking.

STYLES ON PAGE 2

DOCUMENT NUMBER:	98ASB42565B	Electronic versions are uncontrolled except when accessed directly from the Document Repository. Printed versions are uncontrolled except when stamped "CONTROLLED COPY" in red.
DESCRIPTION:	SOIC-14 NB	PAGE 1 OF 2

onsemi and onsemi are trademarks of Semiconductor Components Industries, LLC dba onsemi or its subsidiaries in the United States and/or other countries. onsemi reserves the right to make changes without further notice to any products herein. onsemi makes no warranty, representation or guarantee regarding the suitability of its products for any particular purpose, nor does onsemi assume any liability arising out of the application or use of any product or circuit, and specifically disclaims any and all liability, including without limitation special, consequential or incidental damages. onsemi does not convey any license under its patent rights nor the rights of others.

**SOIC-14**  
**CASE 751A-03**  
**ISSUE L**

DATE 03 FEB 2016

STYLE 1:  
 PIN 1. COMMON CATHODE  
 2. ANODE/CATHODE  
 3. ANODE/CATHODE  
 4. NO CONNECTION  
 5. ANODE/CATHODE  
 6. NO CONNECTION  
 7. ANODE/CATHODE  
 8. ANODE/CATHODE  
 9. ANODE/CATHODE  
 10. NO CONNECTION  
 11. ANODE/CATHODE  
 12. ANODE/CATHODE  
 13. NO CONNECTION  
 14. COMMON ANODE

STYLE 2:  
 CANCELLED

STYLE 3:  
 PIN 1. NO CONNECTION  
 2. ANODE  
 3. ANODE  
 4. NO CONNECTION  
 5. ANODE  
 6. NO CONNECTION  
 7. ANODE  
 8. ANODE  
 9. ANODE  
 10. NO CONNECTION  
 11. ANODE  
 12. ANODE  
 13. NO CONNECTION  
 14. COMMON CATHODE

STYLE 4:  
 PIN 1. NO CONNECTION  
 2. CATHODE  
 3. CATHODE  
 4. NO CONNECTION  
 5. CATHODE  
 6. NO CONNECTION  
 7. CATHODE  
 8. CATHODE  
 9. CATHODE  
 10. NO CONNECTION  
 11. CATHODE  
 12. CATHODE  
 13. NO CONNECTION  
 14. COMMON ANODE

STYLE 5:  
 PIN 1. COMMON CATHODE  
 2. ANODE/CATHODE  
 3. ANODE/CATHODE  
 4. ANODE/CATHODE  
 5. ANODE/CATHODE  
 6. NO CONNECTION  
 7. COMMON ANODE  
 8. COMMON CATHODE  
 9. ANODE/CATHODE  
 10. ANODE/CATHODE  
 11. ANODE/CATHODE  
 12. ANODE/CATHODE  
 13. NO CONNECTION  
 14. COMMON ANODE

STYLE 6:  
 PIN 1. CATHODE  
 2. CATHODE  
 3. CATHODE  
 4. CATHODE  
 5. CATHODE  
 6. CATHODE  
 7. CATHODE  
 8. ANODE  
 9. ANODE  
 10. ANODE  
 11. ANODE  
 12. ANODE  
 13. ANODE  
 14. ANODE

STYLE 7:  
 PIN 1. ANODE/CATHODE  
 2. COMMON ANODE  
 3. COMMON CATHODE  
 4. ANODE/CATHODE  
 5. ANODE/CATHODE  
 6. ANODE/CATHODE  
 7. ANODE/CATHODE  
 8. ANODE/CATHODE  
 9. ANODE/CATHODE  
 10. ANODE/CATHODE  
 11. COMMON CATHODE  
 12. COMMON ANODE  
 13. ANODE/CATHODE  
 14. ANODE/CATHODE

STYLE 8:  
 PIN 1. COMMON CATHODE  
 2. ANODE/CATHODE  
 3. ANODE/CATHODE  
 4. NO CONNECTION  
 5. ANODE/CATHODE  
 6. ANODE/CATHODE  
 7. COMMON ANODE  
 8. COMMON ANODE  
 9. ANODE/CATHODE  
 10. ANODE/CATHODE  
 11. NO CONNECTION  
 12. ANODE/CATHODE  
 13. ANODE/CATHODE  
 14. COMMON CATHODE

<b>DOCUMENT NUMBER:</b>	<b>98ASB42565B</b>	Electronic versions are uncontrolled except when accessed directly from the Document Repository. Printed versions are uncontrolled except when stamped "CONTROLLED COPY" in red.
<b>DESCRIPTION:</b>	<b>SOIC-14 NB</b>	<b>PAGE 2 OF 2</b>

**onsemi** and **ONSEMI** are trademarks of Semiconductor Components Industries, LLC dba **onsemi** or its subsidiaries in the United States and/or other countries. **onsemi** reserves the right to make changes without further notice to any products herein. **onsemi** makes no warranty, representation or guarantee regarding the suitability of its products for any particular purpose, nor does **onsemi** assume any liability arising out of the application or use of any product or circuit, and specifically disclaims any and all liability, including without limitation special, consequential or incidental damages. **onsemi** does not convey any license under its patent rights nor the rights of others.

**onsemi**, **Onsemi**, and other names, marks, and brands are registered and/or common law trademarks of Semiconductor Components Industries, LLC dba "**onsemi**" or its affiliates and/or subsidiaries in the United States and/or other countries. **onsemi** owns the rights to a number of patents, trademarks, copyrights, trade secrets, and other intellectual property. A listing of **onsemi**'s product/patent coverage may be accessed at [www.onsemi.com/site/pdf/Patent-Marking.pdf](http://www.onsemi.com/site/pdf/Patent-Marking.pdf). **onsemi** reserves the right to make changes at any time to any products or information herein, without notice. The information herein is provided "as-is" and **onsemi** makes no warranty, representation or guarantee regarding the accuracy of the information, product features, availability, functionality, or suitability of its products for any particular purpose, nor does **onsemi** assume any liability arising out of the application or use of any product or circuit, and specifically disclaims any and all liability, including without limitation special, consequential or incidental damages. Buyer is responsible for its products and applications using **onsemi** products, including compliance with all laws, regulations and safety requirements or standards, regardless of any support or applications information provided by **onsemi**. "Typical" parameters which may be provided in **onsemi** data sheets and/or specifications can and do vary in different applications and actual performance may vary over time. All operating parameters, including "Typicals" must be validated for each customer application by customer's technical experts. **onsemi** does not convey any license under any of its intellectual property rights nor the rights of others. **onsemi** products are not designed, intended, or authorized for use as a critical component in life support systems or any FDA Class 3 medical devices or medical devices with a same or similar classification in a foreign jurisdiction or any devices intended for implantation in the human body. Should Buyer purchase or use **onsemi** products for any such unintended or unauthorized application, Buyer shall indemnify and hold **onsemi** and its officers, employees, subsidiaries, affiliates, and distributors harmless against all claims, costs, damages, and expenses, and reasonable attorney fees arising out of, directly or indirectly, any claim of personal injury or death associated with such unintended or unauthorized use, even if such claim alleges that **onsemi** was negligent regarding the design or manufacture of the part. **onsemi** is an Equal Opportunity/Affirmative Action Employer. This literature is subject to all applicable copyright laws and is not for resale in any manner.

## ADDITIONAL INFORMATION

### TECHNICAL PUBLICATIONS:

Technical Library: [www.onsemi.com/design/resources/technical-documentation](http://www.onsemi.com/design/resources/technical-documentation)  
onsemi Website: [www.onsemi.com](http://www.onsemi.com)

### ONLINE SUPPORT: [www.onsemi.com/support](http://www.onsemi.com/support)

For additional information, please contact your local Sales Representative at [www.onsemi.com/support/sales](http://www.onsemi.com/support/sales)