

Self-Protected Low Side Driver with Temperature and Current Limit

42 V, 10 A, Single N-Channel, DPAK

NCV8408, NCV8408B

NCV8408/B is a single channel protected Low-Side Smart Discrete device. The protection features include overcurrent, overtemperature, ESD and integrated Drain-to-Gate clamping for overvoltage protection. Thermal protection includes a latch which can be reset by toggling the input. This device is suitable for harsh automotive environments.

Features

- Short Circuit Protection
- Thermal Shutdown with Latched Reset
- Gate Input Current Flag During Latched Fault Condition
- Overvoltage Protection
- Integrated Clamp for Inductive Switching
- ESD Protection
- dV/dt Robustness
- Analog Drive Capability (Logic Level Input)
- NCV Prefix for Automotive and Other Applications Requiring Unique Site and Control Change Requirements; AEC-Q101 Qualified and PPAP Capable
- These Devices are Pb-Free, Halogen Free/BFR Free and are RoHS Compliant

Typical Applications

- Switch a Variety of Resistive, Inductive and Capacitive Loads
- Can Replace Electromechanical Relays and Discrete Circuits
- Automotive / Industrial

V _{DSS} (Clamped)	R _{DS(on)} TYP	I _D MAX (Limited)
42 V	55 mΩ @ 5 V	10 A

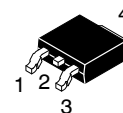
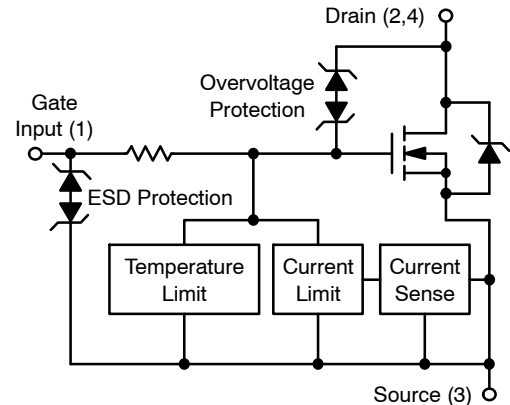

DPAK
CASE 369C
STYLE 2

MARKING DIAGRAMS

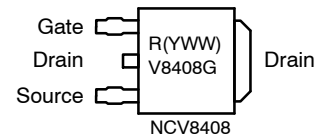

R = Site Code
Y = Year
WW = Work Week
G = Pb-Free Package

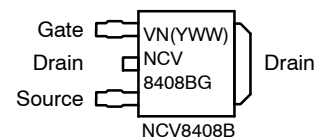

VN = Site Code
Y = Year
WW = Work Week
G = Pb-Free Package

ORDERING INFORMATION

Device	Package	Shipping [†]
NCV8408DTRKG	DPAK (Pb-Free)	2500/Tape & Reel
NCV8408BDTRKG	DPAK (Pb-Free)	2500/Tape & Reel

[†]For information on tape and reel specifications, including part orientation and tape sizes, please refer to our Tape and Reel Packaging Specification Brochure, BRD8011/D.

NCV8408, NCV8408B

MAXIMUM RATINGS ($T_J = 25^\circ\text{C}$ unless otherwise noted)

Rating	Symbol	Value	Unit
Drain-to-Source Voltage Internally Clamped	V_{DSS}	42	Vdc
Drain-to-Gate Voltage Internally Clamped ($R_{GS} = 1.0\text{ M}\Omega$)	V_{DGR}	42	V
Gate-to-Source Voltage	V_{GS}	± 14	Vdc
Continuous Drain Current	I_D	Internally Limited	
Gate Input Current ($V_{GS} = \pm 14\text{ V}_{DC}$)	I_{GS}	± 10	mA
Source to Drain Current	I_{SD}	4.0	A
Total Power Dissipation @ $T_A = 25^\circ\text{C}$ (Note 1) @ $T_A = 25^\circ\text{C}$ (Note 2)	P_D	1.8 2.3	W
Thermal Resistance Junction-to-Ambient Steady State (Note 1) Junction-to-Ambient Steady State (Note 2) Junction-to-Tab Steady State (Note 3)	$R_{\theta JA}$ $R_{\theta JA}$ $R_{\theta JT}$	70 55 2.1	$^\circ\text{C/W}$
Single Pulse Inductive Load Switching Energy ($V_{DD} = 20\text{ Vdc}$, $V_{GS} = 5.0\text{ V}$, $I_L = 8.0\text{ A}$)	E_{AS}	185	mJ
Repetitive Pulse Inductive Load Switching Energy ($V_{DD} = 20\text{ Vdc}$, $V_{GS} = 5.0\text{ V}$, $I_L = 8.0\text{ A}$, $T_J = 25^\circ\text{C}$)	E_{AR}	128	
Repetitive Pulse Inductive Load Switching Energy ($V_{DD} = 20\text{ Vdc}$, $V_{GS} = 5.0\text{ V}$, $I_L = 6.8\text{ A}$, $T_J = 105^\circ\text{C}$)	E_{AR}	92	
Load Dump Voltage ($V_{GS} = 0$ and 10 V , $R_I = 2.0\ \Omega$, $R_L = 4.5\ \Omega$, $t_d = 400\text{ ms}$, $T_J = 25^\circ\text{C}$)	V_{LD}	63	V
Operating Junction Temperature	T_J	-40 to 150	$^\circ\text{C}$
Storage Temperature	T_{stg}	-55 to 150	$^\circ\text{C}$

Stresses exceeding those listed in the Maximum Ratings table may damage the device. If any of these limits are exceeded, device functionality should not be assumed, damage may occur and reliability may be affected.

1. Surface-mounted onto minimum pad FR4 PCB (1 oz Cu, 0.06" thick).
2. Surface-mounted onto 2" square FR4 PCB, (1" square, 1 oz Cu, 0.06" thick).
3. Surface-mounted onto minimum pad FR4 PCB (2 oz Cu, 0.06" thick).

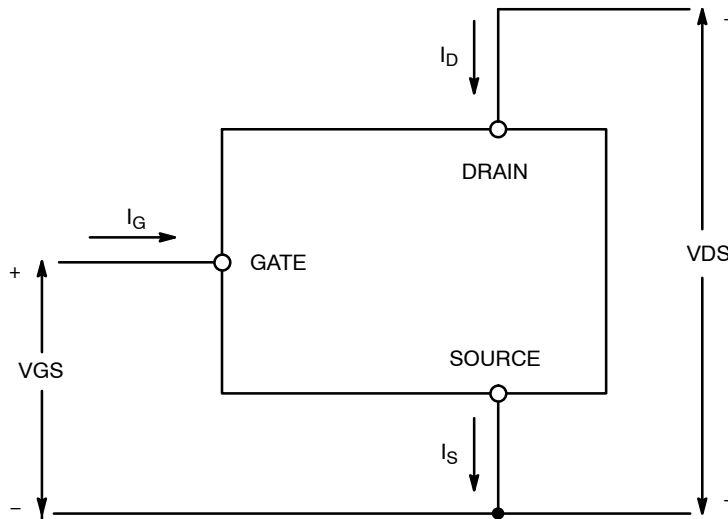

Figure 1. Voltage and Current Convention

NCV8408, NCV8408B

ELECTRICAL CHARACTERISTICS (T_J = 25°C unless otherwise noted)

Characteristic	Test Conditions	Symbol	Min	Typ	Max	Unit
----------------	-----------------	--------	-----	-----	-----	------

OFF CHARACTERISTICS

Drain-to-Source Clamped Breakdown Voltage (Note 4) (V _{GS} = 0 V, I _D = 10 mA, T _J = 25°C) (V _{GS} = 0 V, I _D = 10 mA, T _J = 150°C) (Note 6) (V _{GS} = 0 V, I _D = 10 mA, T _J = -40°C) (Note 6)		V _{(BR)DSS}	42 40 43	46 45 47	51 51 51	V
Zero Gate Voltage Drain Current (V _{GS} = 0 V, V _{DS} = 32 V, T _J = 25°C) (V _{GS} = 0 V, V _{DS} = 32 V, T _J = 150°C) (Note 6)		I _{DSS}	- -	0.6 2.5	5.0 10	μA

INPUT CHARACTERISTICS (Note 4)

Gate Input Current – Normal Operation	(V _{GS} = 5.0 V)	I _{GSSF}	-	25	50	μA
Gate Input Current – Protection Latched	(V _{GS} = 5.0 V) (Note 6)	I _{GSSL}	-	440	-	μA
Gate Threshold Voltage	(V _{GS} = V _{DS} , I _D = 1 mA)	V _{GS(th)}	1.0	1.7	2.2	V
Gate Threshold Temperature Coefficient		V _{GS(th)} /T _J	-	5.0	-	-mV/°C
Latched Reset Voltage	(Note 6)	V _{LR}	0.8	1.4	1.9	V
Latched Reset Time	(V _{GS} = 5.0 V to V _{GS} < 1 V) (Note 6)	t _{LR}	10	40	100	μs
Internal Gate Input Resistance			-	25.5	-	kΩ

ON CHARACTERISTICS (Note 4)

Static Drain-to-Source On-Resistance (V _{GS} = 5.0 V, I _D = 3.0 A, T _J @ 25°C) (V _{GS} = 5.0 V, I _D = 3.0 A, T _J @ 150°C) (Note 6)		R _{DS(on)}	- -	55 100	60 120	mΩ
Source-Drain Forward On Voltage	(V _{GS} = 0 V, I _S = 7.0 A)	V _{SD}	-	0.95	-	V

SWITCHING CHARACTERISTICS (Note 6)

Turn-OFF/ON Slew Rate Matching	V _{GS} = 5.0 V, V _{DS} = 13 V, R _L = 4 Ω; T _J = -40°C T _J = 150°C T _J = 25°C -40°C < T _J < 150°C	T _{Match}	-15 -15 -5 -20	- - - -	15 15 5 20	%
Turn-ON Delay Time	V _{GS} = 5 V, V _{DS} = 13 V R _L = 4 Ω, -40°C < T _J < 150°C	t _{d(ON)}		10	20	μs
Rise Time (10% I _D to 90% I _D)		t _r		20	40	
Turn-OFF Delay Time		t _{d(OFF)}		30	60	
Fall Time (90% I _D to 10% I _D)		t _f		20	40	
Slew-Rate ON (90% V _D to 10% V _D)		-dV _{DS} /dt _{ON}		0.5		
Slew-Rate OFF (10% V _D to 90% V _D)		dV _{DS} /dt _{OFF}		0.5		

SELF PROTECTION CHARACTERISTICS (T_J = 25°C unless otherwise noted) (Note 5)

Current Limit V _{GS} = 5.0 V, V _{DS} = 10 V, T _J @ 25°C (Note 7) V _{GS} = 5.0 V, V _{DS} = 10 V, T _J = 150°C (Notes 6, 7) V _{GS} = 5.0 V, V _{DS} = 10 V, T _J = -40°C (Notes 6, 7)		I _{LIM}	10 10 9	13 - -	16 18 16	A
Temperature Limit (Turn-off)	V _{GS} = 5.0 V V _{GS} = 10 V	T _{LIM(off)}	150 150	175 165	200 185	°C

ESD ELECTRICAL CHARACTERISTICS (T_J = 25°C unless otherwise noted)

Electro-Static Discharge Capability	Human Body Model (HBM)	ESD	4000	-	-	V
Electro-Static Discharge Capability	Machine Model (MM)	ESD	400	-	-	V

Product parametric performance is indicated in the Electrical Characteristics for the listed test conditions, unless otherwise noted. Product performance may not be indicated by the Electrical Characteristics if operated under different conditions.

4. Pulse Test: Pulse Width = 300 μs, Duty Cycle = 2%.
5. Fault conditions are viewed as beyond the normal operating range of the part.
6. Not subject to production testing.
7. Refer to Application Note AND8202/D for dependence of protection features on gate voltage.

NCV8408, NCV8408B

TEST CIRCUITS AND WAVEFORMS

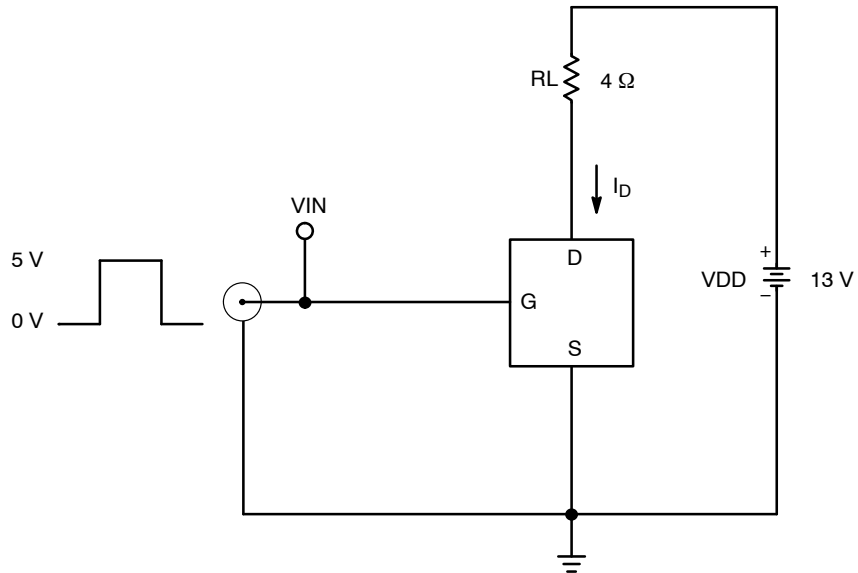

Figure 2. Resistive Load Switching Test Circuit

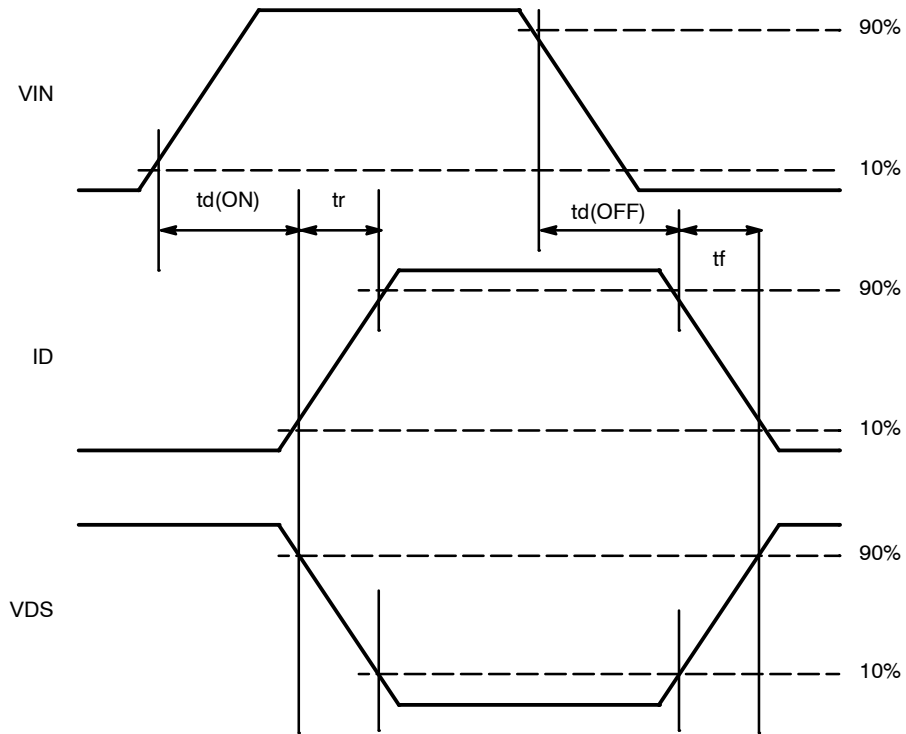

Figure 3. Resistive Load Switching Waveforms

NCV8408, NCV8408B

TEST CIRCUITS AND WAVEFORMS

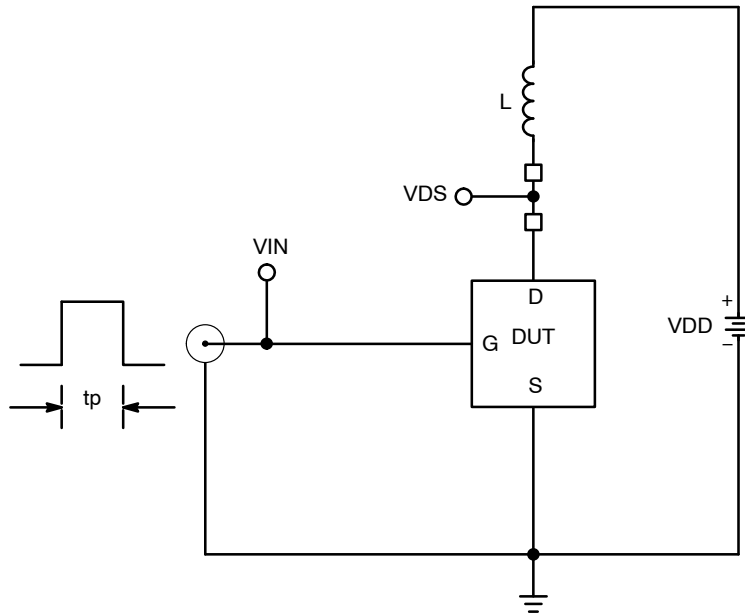

Figure 4. Inductive Load Switching Test Circuit

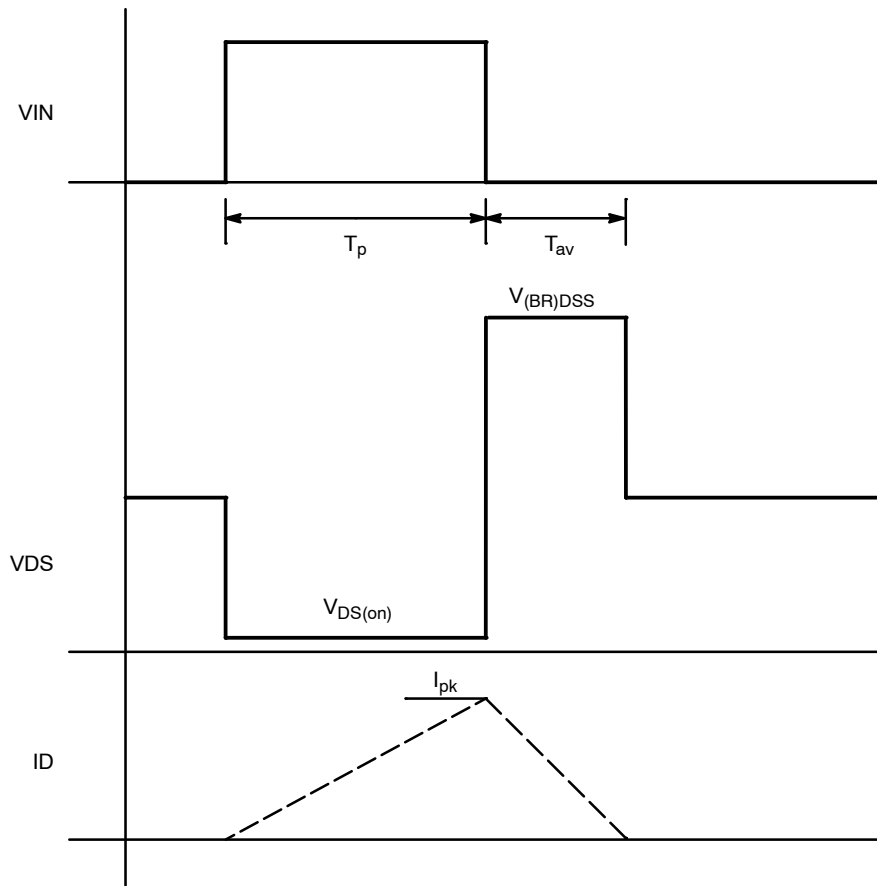

Figure 5. Inductive Load Switching Waveforms

NCV8408, NCV8408B

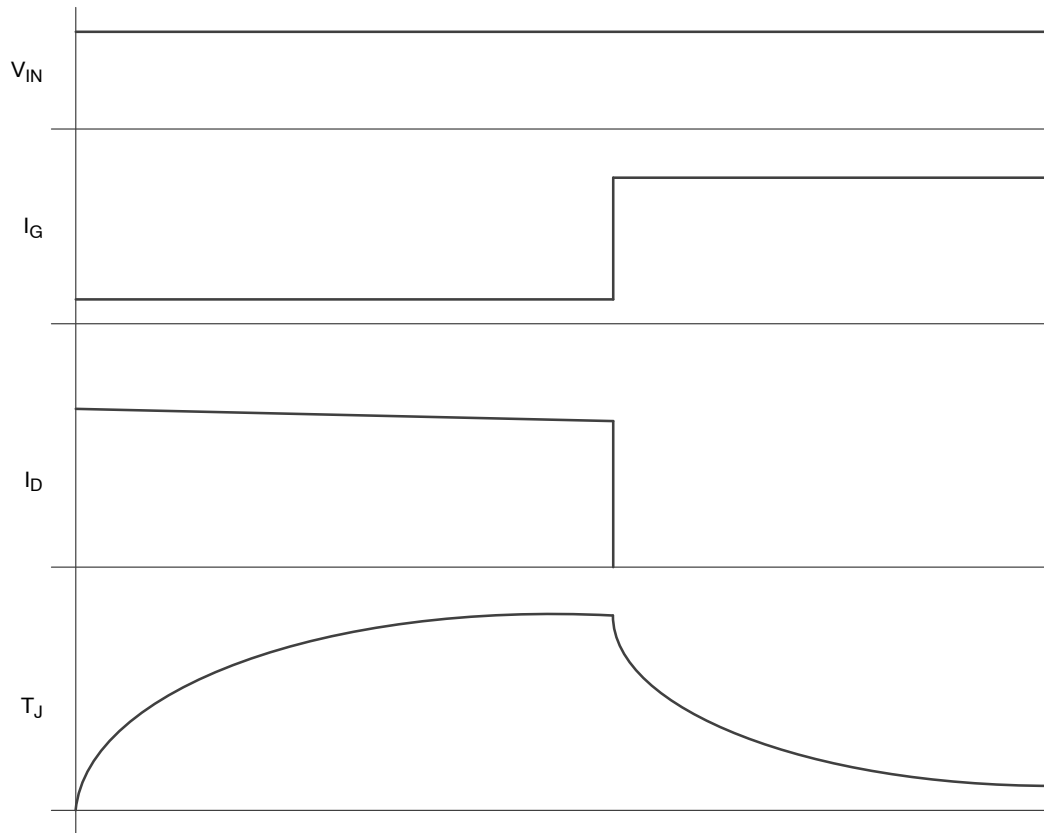

Figure 6. Short-Circuit Protection Behavior

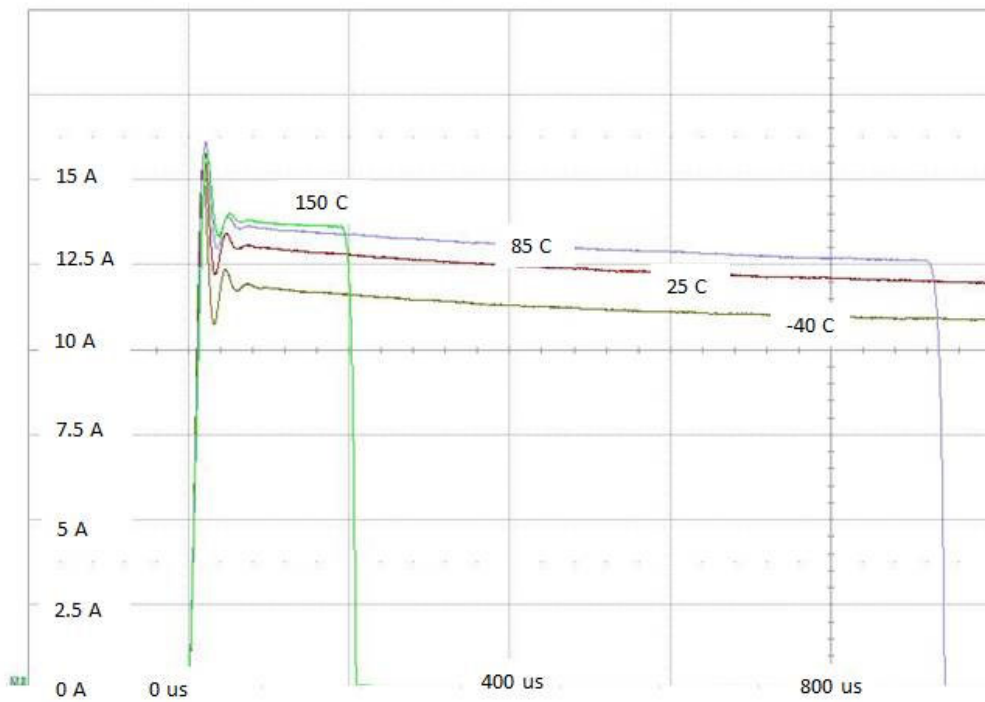

Figure 7. Turn on into Short Circuit Device Response

NCV8408, NCV8408B

TYPICAL CHARACTERISTICS

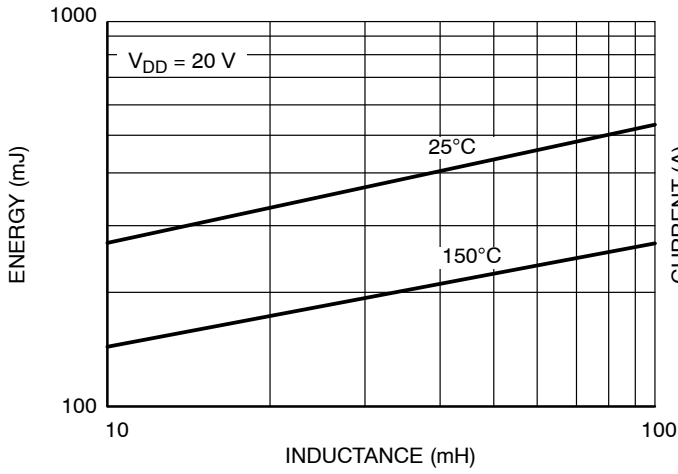

Figure 8. NCV8408 Maximum Switch Off Energy vs Inductance

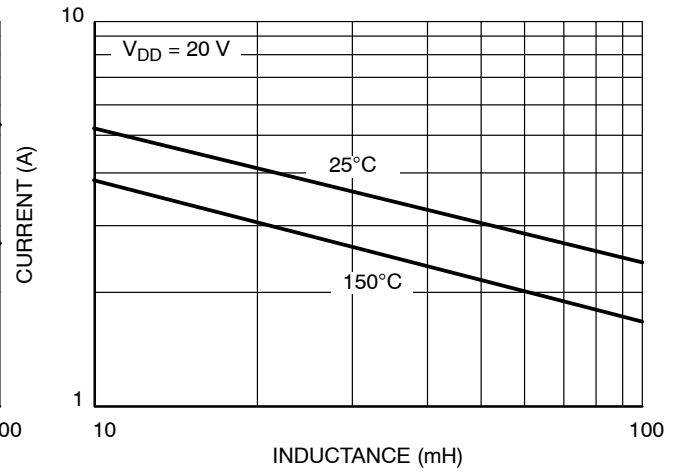

Figure 9. NCV8408 Maximum Switch Off Current vs Inductance

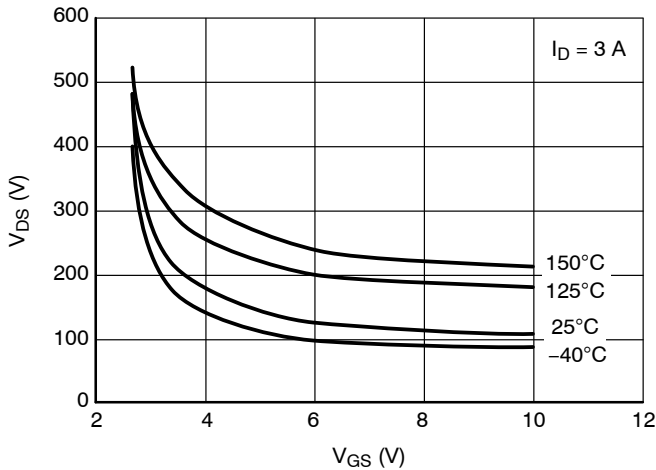

Figure 10. V_{GS} vs V_{DS}

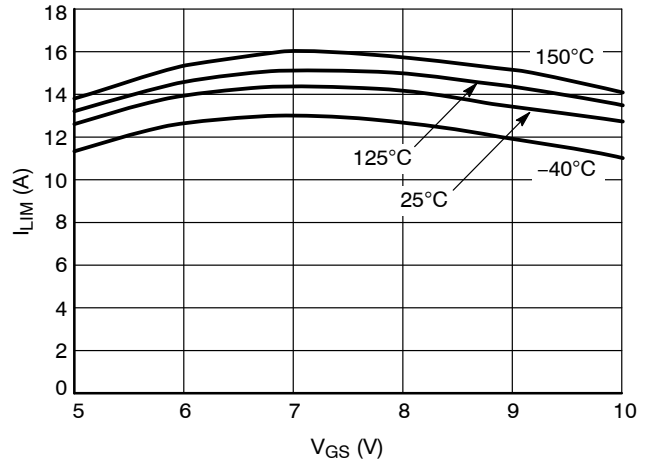

Figure 11. Current Limit vs. Gate Voltage

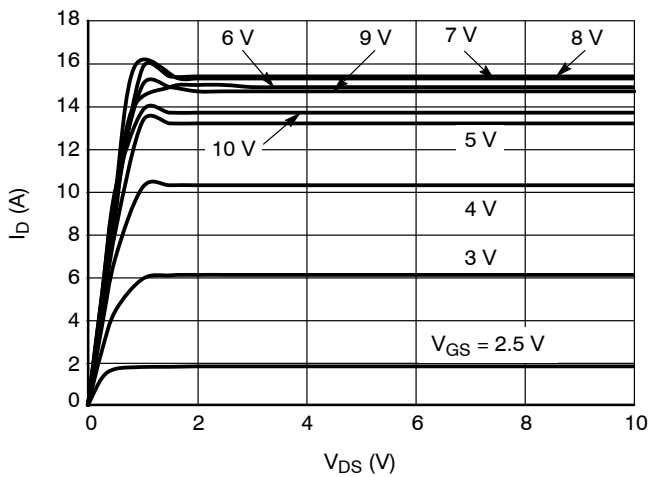

Figure 12. Drain Current vs. Drain Voltage

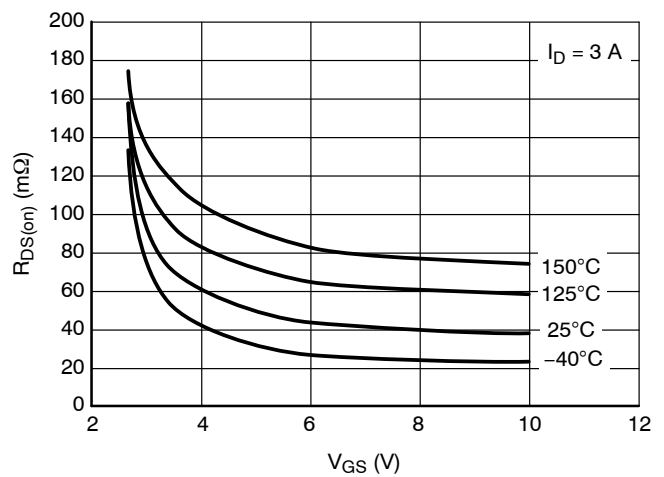

Figure 13. $R_{DS(on)}$ vs. Gate Voltage

NCV8408, NCV8408B

TYPICAL CHARACTERISTICS

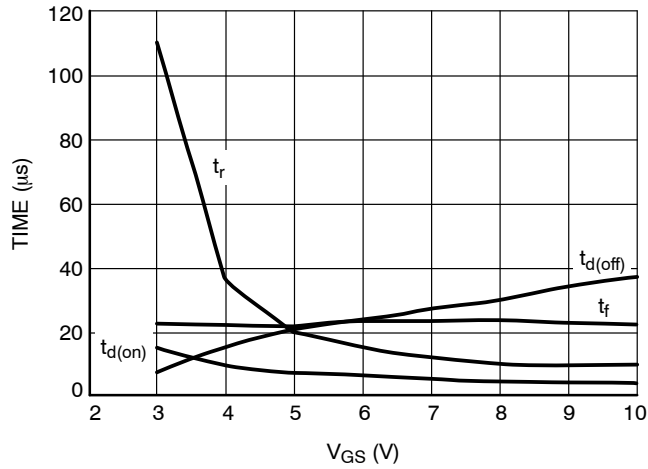

Figure 14. Resistive Switching

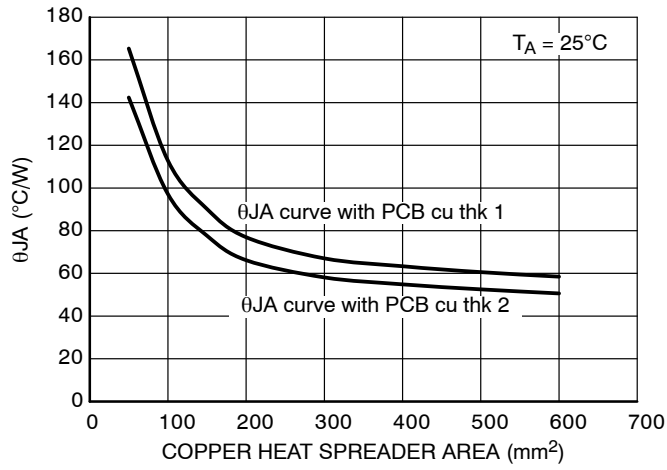

Figure 15. $R_{\theta JA}$ vs. Copper Area

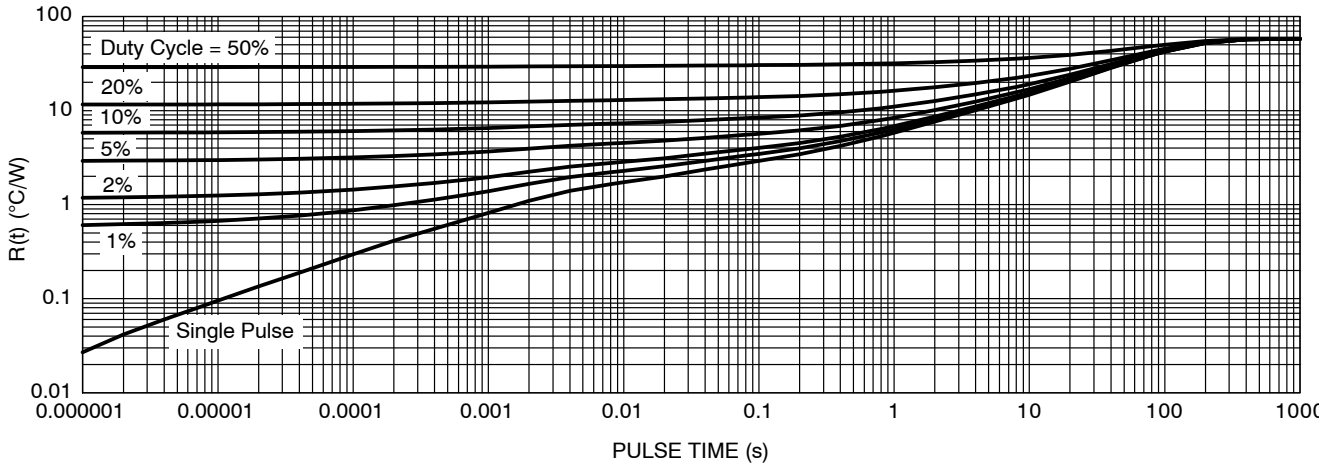
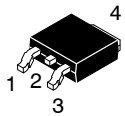

Figure 16. Transient Thermal Resistance

MECHANICAL CASE OUTLINE PACKAGE DIMENSIONS



DPAK (SINGLE GAUGE) CASE 369C ISSUE G

DATE 31 MAY 2023

SCALE 1:1

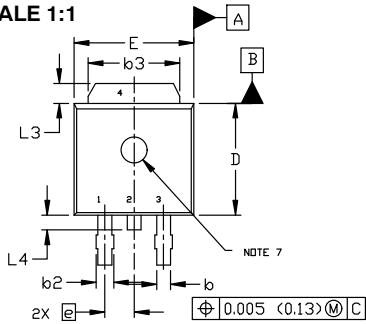

TOP VIEW

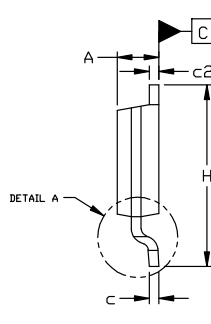

SIDE VIEW

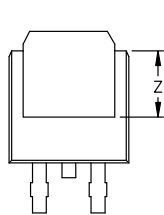

BOTTOM VIEW

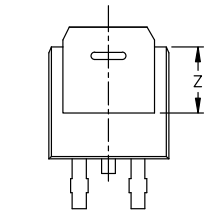
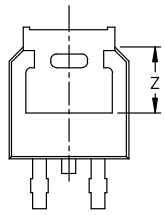

BOTTOM VIEW

ALTERNATE CONSTRUCTIONS

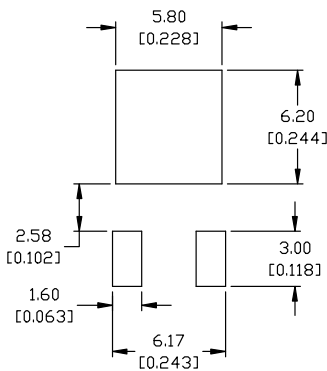

RECOMMENDED MOUNTING FOOTPRINT*

*FOR ADDITIONAL INFORMATION ON OUR Pb-FREE STRATEGY AND SOLDERING DETAILS, PLEASE DOWNLOAD THE ON SEMICONDUCTOR SOLDERING AND MOUNTING TECHNIQUES REFERENCE MANUAL, SOLDERRM/D.

STYLE 1:

- PIN 1. BASE
- 2. COLLECTOR
- 3. EMITTER
- 4. COLLECTOR

STYLE 2:

- PIN 1. GATE
- 2. DRAIN
- 3. SOURCE
- 4. DRAIN

STYLE 3:

- PIN 1. ANODE
- 2. CATHODE
- 3. ANODE
- 4. CATHODE

STYLE 4:

- PIN 1. CATHODE
- 2. ANODE
- 3. GATE
- 4. ANODE

STYLE 5:

- PIN 1. GATE
- 2. ANODE
- 3. CATHODE
- 4. ANODE

STYLE 6:

- PIN 1. MT1
- 2. MT2
- 3. GATE
- 4. MT2

STYLE 7:

- PIN 1. GATE
- 2. COLLECTOR
- 3. EMITTER
- 4. COLLECTOR

STYLE 8:

- PIN 1. N/C
- 2. CATHODE
- 3. ANODE
- 4. CATHODE

STYLE 9:

- PIN 1. ANODE
- 2. CATHODE
- 3. RESISTOR ADJUST
- 4. CATHODE

STYLE 10:

- PIN 1. CATHODE
- 2. ANODE
- 3. CATHODE
- 4. ANODE

NOTES:

1. DIMENSIONING AND TOLERANCING ASME Y14.5M, 1994.
2. CONTROLLING DIMENSION: INCHES
3. THERMAL PAD CONTOUR OPTIONAL WITHIN DIMENSIONS b3, L3, AND Z.
4. DIMENSIONS D AND E DO NOT INCLUDE MOLD FLASH, PROTRUSIONS, OR BURRS. MOLD FLASH, PROTRUSIONS, OR GATE BURRS SHALL NOT EXCEED 0.006 INCHES PER SIDE.
5. DIMENSIONS D AND E ARE DETERMINED AT THE OUTERMOST EXTREMES OF THE PLASTIC BODY.
6. DATUMS A AND B ARE DETERMINED AT DATUM PLANE H.
7. OPTIONAL MOLD FEATURE.

DIM	INCHES		MILLIMETERS	
	MIN.	MAX.	MIN.	MAX.
A	0.086	0.094	2.18	2.38
A1	0.000	0.005	0.00	0.13
b	0.025	0.035	0.63	0.89
b2	0.028	0.045	0.72	1.14
b3	0.180	0.215	4.57	5.46
c	0.018	0.024	0.46	0.61
c2	0.018	0.024	0.46	0.61
D	0.235	0.245	5.97	6.22
E	0.250	0.265	6.35	6.73
e	0.090	BSC	2.29	BSC
H	0.370	0.410	9.40	10.41
L	0.055	0.070	1.40	1.78
L1	0.114	REF	2.90	REF
L2	0.020	BSC	0.51	BSC
L3	0.035	0.050	0.89	1.27
L4	---	0.040	---	1.01
Z	0.155	---	3.93	---

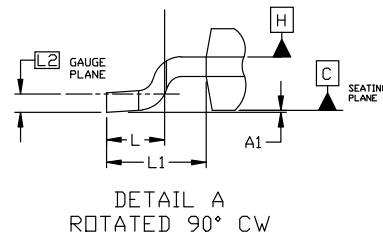

DETAIL A
ROTATED 90° CW

GENERIC MARKING DIAGRAM*



IC

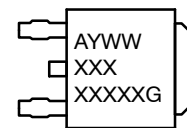

Discrete

- XXXXXX = Device Code
- A = Assembly Location
- L = Wafer Lot
- Y = Year
- WW = Work Week
- G = Pb-Free Package

*This information is generic. Please refer to device data sheet for actual part marking. Pb-Free indicator, "G" or microdot "•", may or may not be present. Some products may not follow the Generic Marking.

DOCUMENT NUMBER:	98AON10527D	Electronic versions are uncontrolled except when accessed directly from the Document Repository. Printed versions are uncontrolled except when stamped "CONTROLLED COPY" in red.
DESCRIPTION:	DPAK (SINGLE GAUGE)	PAGE 1 OF 1

onsemi and Onsemi are trademarks of Semiconductor Components Industries, LLC dba onsemi or its subsidiaries in the United States and/or other countries. onsemi reserves the right to make changes without further notice to any products herein. onsemi makes no warranty, representation or guarantee regarding the suitability of its products for any particular purpose, nor does onsemi assume any liability arising out of the application or use of any product or circuit, and specifically disclaims any and all liability, including without limitation special, consequential or incidental damages. onsemi does not convey any license under its patent rights nor the rights of others.

onsemi, **Onsemi**, and other names, marks, and brands are registered and/or common law trademarks of Semiconductor Components Industries, LLC dba "**onsemi**" or its affiliates and/or subsidiaries in the United States and/or other countries. **onsemi** owns the rights to a number of patents, trademarks, copyrights, trade secrets, and other intellectual property. A listing of **onsemi**'s product/patent coverage may be accessed at www.onsemi.com/site/pdf/Patent-Marking.pdf. **onsemi** reserves the right to make changes at any time to any products or information herein, without notice. The information herein is provided "as-is" and **onsemi** makes no warranty, representation or guarantee regarding the accuracy of the information, product features, availability, functionality, or suitability of its products for any particular purpose, nor does **onsemi** assume any liability arising out of the application or use of any product or circuit, and specifically disclaims any and all liability, including without limitation special, consequential or incidental damages. Buyer is responsible for its products and applications using **onsemi** products, including compliance with all laws, regulations and safety requirements or standards, regardless of any support or applications information provided by **onsemi**. "Typical" parameters which may be provided in **onsemi** data sheets and/or specifications can and do vary in different applications and actual performance may vary over time. All operating parameters, including "Typicals" must be validated for each customer application by customer's technical experts. **onsemi** does not convey any license under any of its intellectual property rights nor the rights of others. **onsemi** products are not designed, intended, or authorized for use as a critical component in life support systems or any FDA Class 3 medical devices or medical devices with a same or similar classification in a foreign jurisdiction or any devices intended for implantation in the human body. Should Buyer purchase or use **onsemi** products for any such unintended or unauthorized application, Buyer shall indemnify and hold **onsemi** and its officers, employees, subsidiaries, affiliates, and distributors harmless against all claims, costs, damages, and expenses, and reasonable attorney fees arising out of, directly or indirectly, any claim of personal injury or death associated with such unintended or unauthorized use, even if such claim alleges that **onsemi** was negligent regarding the design or manufacture of the part. **onsemi** is an Equal Opportunity/Affirmative Action Employer. This literature is subject to all applicable copyright laws and is not for resale in any manner.

ADDITIONAL INFORMATION

TECHNICAL PUBLICATIONS:

Technical Library: www.onsemi.com/design/resources/technical-documentation
onsemi Website: www.onsemi.com

ONLINE SUPPORT: www.onsemi.com/support

For additional information, please contact your local Sales Representative at www.onsemi.com/support/sales