

LDO Regulator - Ultra-Low Noise, High PSRR, RF and Analog Circuits

250 mA

NCV8160

The NCV8160 is a linear regulator capable of supplying 250 mA output current. Designed to meet the requirements of RF and analog circuits, the NCV8160 device provides low noise, high PSRR, low quiescent current, and very good load/line transients. The device is designed to work with a 1 μ F input and a 1 μ F output ceramic capacitor. It is available in XDFN-4 0.65P, 1 mm x 1 mm.

Features

- Operating Input Voltage Range: 1.9 V to 5.5 V
- Available in Fixed Voltage Option: 1.8 V to 5.14 V
- $\pm 2\%$ Accuracy Over Temperature
- Ultra Low Quiescent Current Typ. 18 μ A
- Standby Current: Typ. 0.1 μ A
- Very Low Dropout: 90 mV at 250 mA
- Ultra High PSRR: Typ. 98 dB at 20 mA, f = 1 kHz
- Ultra Low Noise: 10 μ V_{RMS}
- Stable with a 1 μ F Small Case Size Ceramic Capacitors
- Available in XDFN4 1 mm x 1 mm x 0.4 mm
- NCV Prefix for Automotive and Other Applications Requiring Unique Site and Control Change Requirements; Grade 1 AEC-Q100 Qualified and PPAP Capable
- These Devices are Pb-Free, Halogen Free/BFR Free and are RoHS Compliant

Typical Applications

- ADAS, Infotainment & Cluster, and Telematics
- General Purpose Automotive & Industrial
- Building & Factory Automation, Smart Meters

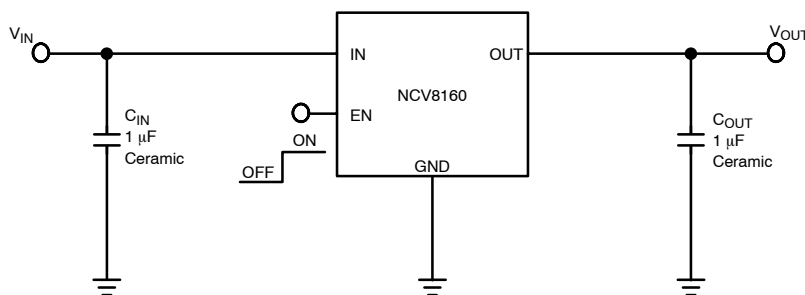
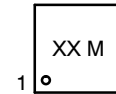

Figure 1. Typical Application Schematics

MARKING DIAGRAM



XDFN4
CASE 711AJ



XX = Specific Device Code
M = Date Code

PIN CONNECTIONS

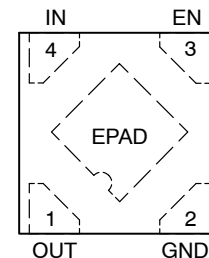

(Top View)

ORDERING INFORMATION

See detailed ordering, marking and shipping information on page 13 of this data sheet.

NCV8160

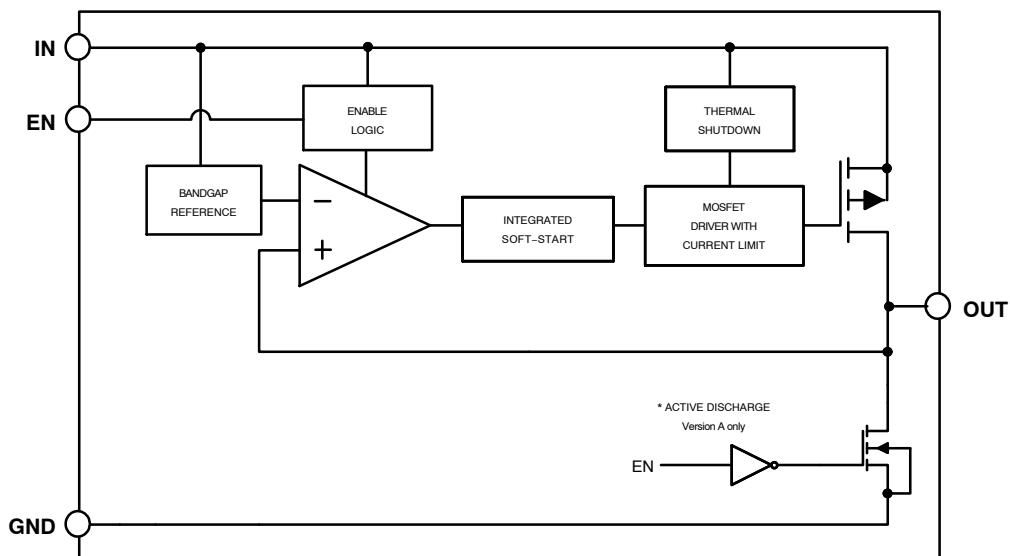

Figure 2. Simplified Schematic Block Diagram

PIN FUNCTION DESCRIPTION

Pin No.	Pin Name	Description
1	OUT	Regulated output voltage. The output should be bypassed with small 1 μ F ceramic capacitor.
2	GND	Common ground connection
3	EN	Chip enable: Applying $V_{EN} < 0.4$ V disables the regulator, Pulling $V_{EN} > 1.2$ V enables the LDO.
4	IN	Input voltage supply pin
EPAD	EPAD	Expose pad can be tied to ground plane for better power dissipation

NCV8160

ABSOLUTE MAXIMUM RATINGS

Rating	Symbol	Value	Unit
Input Voltage (Note 1)	V_{IN}	-0.3 V to 6	V
Output Voltage	V_{OUT}	-0.3 to $V_{IN} + 0.3$, max. 6 V	V
Chip Enable Input	V_{CE}	-0.3 to $V_{IN} + 0.3$, max. 6 V	V
Output Short Circuit Duration	t_{SC}	unlimited	s
Operating Ambient Temperature Range	T_A	-40 to +125	°C
Maximum Junction Temperature	T_J	150	°C
Storage Temperature	T_{STG}	-55 to 150	°C
ESD Capability, Human Body Model (Note 2)	ESD_{HBM}	2000	V
ESD Capability, Machine Model (Note 2)	ESD_{MM}	200	V

Stresses exceeding Maximum Ratings may damage the device. Maximum Ratings are stress ratings only. Functional operation above the Recommended Operating Conditions is not implied. Extended exposure to stresses above the Recommended Operating Conditions may affect device reliability.

1. Refer to ELECTRICAL CHARACTERISTICS and APPLICATION INFORMATION for Safe Operating Area.
2. This device series incorporates ESD protection and is tested by the following methods:
 ESD Human Body Model tested per EIA/JESD22-A114
 ESD Machine Model tested per EIA/JESD22-A115
 Latchup Current Maximum Rating tested per JEDEC standard: JESD78.

THERMAL CHARACTERISTICS

Rating	Symbol	Value	Unit
Thermal Characteristics, XDFN4 (Note 3) Thermal Resistance, Junction-to-Air	$R_{\theta JA}$	198.1	°C/W

3. Measured according to JEDEC board specification. Detailed description of the board can be found in JESD51-7

RECOMMENDED OPERATING CONDITIONS

Parameter	Symbol	Min	Max	Unit
Input Voltage	V_{IN}	1.9	5.5	V
Junction Temperature	T_J	-40	125	°C

Functional operation above the stresses listed in the Recommended Operating Ranges is not implied. Extended exposure to stresses beyond the Recommended Operating Ranges limits may affect device reliability.

NCV8160

ELECTRICAL CHARACTERISTICS $-40^{\circ}\text{C} \leq T_J \leq 125^{\circ}\text{C}$; $V_{IN} = V_{OUT(NOM)} + 1\text{ V}$; $I_{OUT} = 1\text{ mA}$, $C_{IN} = C_{OUT} = 1\text{ }\mu\text{F}$, unless otherwise noted. $V_{EN} = 1.2\text{ V}$. Typical values are at $T_J = +25^{\circ}\text{C}$ (Note 4).

Parameter	Test Conditions	Symbol	Min	Typ	Max	Unit
Operating Input Voltage		V_{IN}	1.9		5.5	V
Output Voltage Accuracy	$-40^{\circ}\text{C} \leq T_J \leq 125^{\circ}\text{C}$	V_{OUT}	-2		+2	%
Line Regulation	$V_{OUT(NOM)} + 1\text{ V} \leq V_{IN} \leq 5.5\text{ V}$	$Line_{Reg}$		0.02		%/V
Load Regulation	$I_{OUT} = 1\text{ mA}$ to 250 mA	$Load_{Reg}$		0.001	0.005	%/mA
Dropout Voltage (Note 5)	$I_{OUT} = 250\text{ mA}$	V_{DO}		190	250	mV
				120	175	
				105	160	
				100	155	
				90	145	
Output Current Limit	$V_{OUT} = 90\% V_{OUT(NOM)}$	I_{CL}	250	700		mA
Short Circuit Current	$V_{OUT} = 0\text{ V}$	I_{SC}		690		
Quiescent Current	$I_{OUT} = 0\text{ mA}$	I_Q		18	23	μA
Shutdown Current	$V_{EN} \leq 0.4\text{ V}$, $V_{IN} = 4.8\text{ V}$	I_{DIS}		0.01	1	μA
EN Pin Threshold Voltage	EN Input Voltage "H"	V_{ENH}	1.2			V
	EN Input Voltage "L"	V_{ENL}			0.4	
EN Pull Down Current	$V_{EN} = 4.8\text{ V}$	I_{EN}		0.2	0.5	μA
Turn-On Time	$C_{OUT} = 1\text{ }\mu\text{F}$, From assertion of V_{EN} to $V_{OUT} = 95\% V_{OUT(NOM)}$			120		μs
Power Supply Rejection Ratio	$I_{OUT} = 20\text{ mA}$	$PSRR$	$f = 100\text{ Hz}$	91		dB
	$f = 1\text{ kHz}$		98			
	$f = 10\text{ kHz}$		82			
	$f = 100\text{ kHz}$		48			
Output Voltage Noise	$f = 10\text{ Hz}$ to 100 kHz	V_N		14	10	μV_{RMS}
Thermal Shutdown Threshold	Temperature rising	T_{SDH}		160		$^{\circ}\text{C}$
	Temperature falling	T_{SDL}		140		$^{\circ}\text{C}$
Active Output Discharge Resistance	$V_{EN} < 0.4\text{ V}$, Version A only	R_{DIS}		280		Ω
Line Transient (Note 6)	$V_{IN} = (V_{OUT(NOM)} + 1\text{ V})$ to $(V_{OUT(NOM)} + 1.6\text{ V})$ in 30 μs , $I_{OUT} = 1\text{ mA}$	$Tran_{LINE}$	-1			mV
	$V_{IN} = (V_{OUT(NOM)} + 1.6\text{ V})$ to $(V_{OUT(NOM)} + 1\text{ V})$ in 30 μs , $I_{OUT} = 1\text{ mA}$				+1	
Load Transient (Note 6)	$I_{OUT} = 1\text{ mA}$ to 200 mA in 10 μs	$Tran_{LOAD}$	-40			mV
	$I_{OUT} = 200\text{ mA}$ to 1mA in 10 μs				+40	

Product parametric performance is indicated in the Electrical Characteristics for the listed test conditions, unless otherwise noted. Product performance may not be indicated by the Electrical Characteristics if operated under different conditions.

4. Performance guaranteed over the indicated operating temperature range by design and/or characterization. Production tested at $T_A = 25^{\circ}\text{C}$.

Low duty cycle pulse techniques are used during the testing to maintain the junction temperature as close to ambient as possible.

5. Dropout voltage is characterized when V_{OUT} falls 100 mV below $V_{OUT(NOM)}$.

6. Guaranteed by design.

TYPICAL CHARACTERISTICS

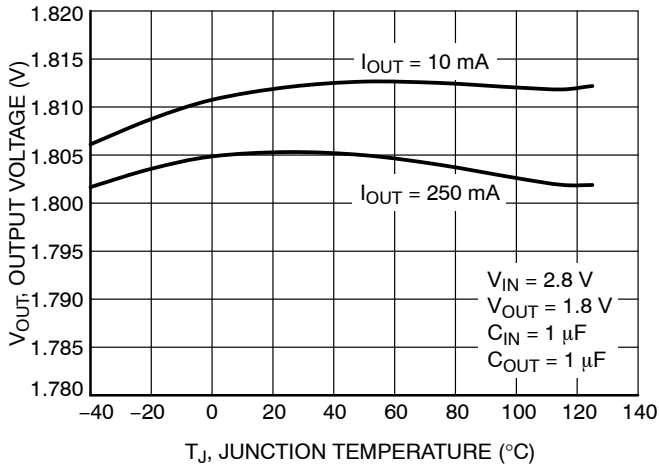

Figure 3. Output Voltage vs. Temperature – $V_{OUT} = 1.8\text{ V}$ – XDFN Package

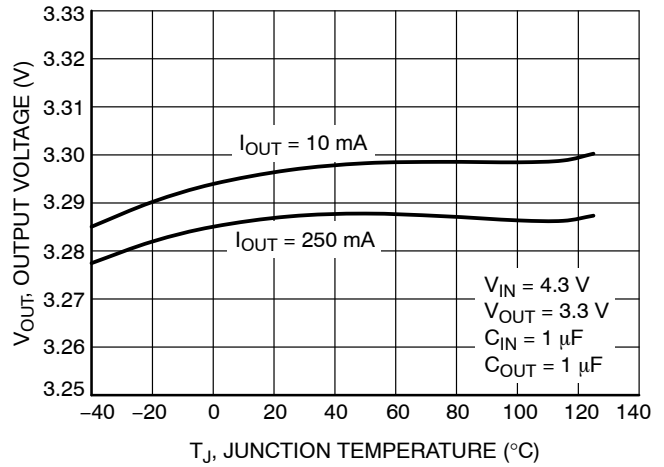

Figure 4. Output Voltage vs. Temperature – $V_{OUT} = 3.3\text{ V}$ – XDFN Package

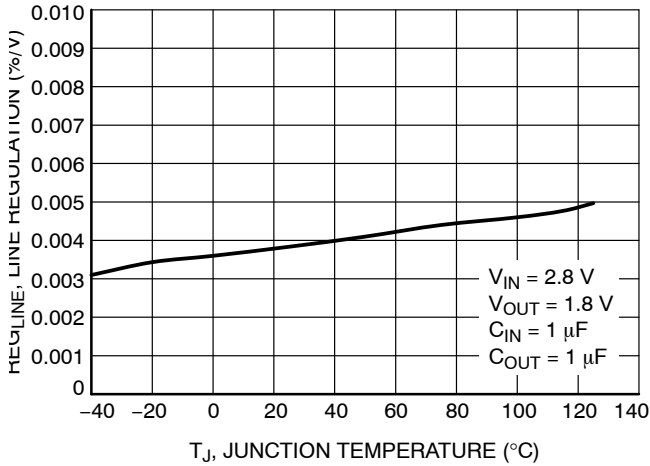

Figure 5. Line Regulation vs. Temperature – $V_{OUT} = 1.8\text{ V}$

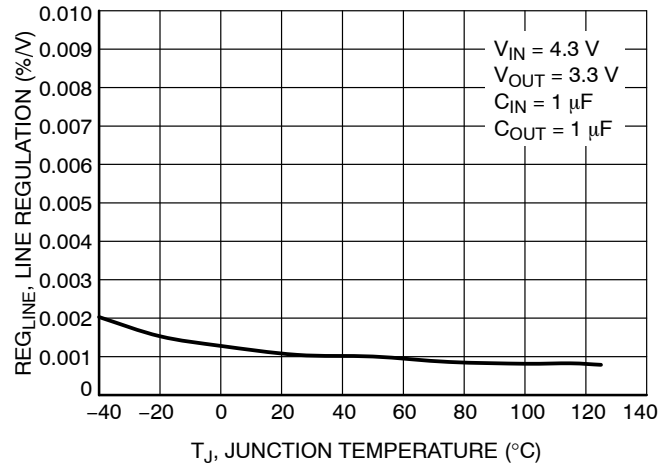

Figure 6. Line Regulation vs. Temperature – $V_{OUT} = 3.3\text{ V}$

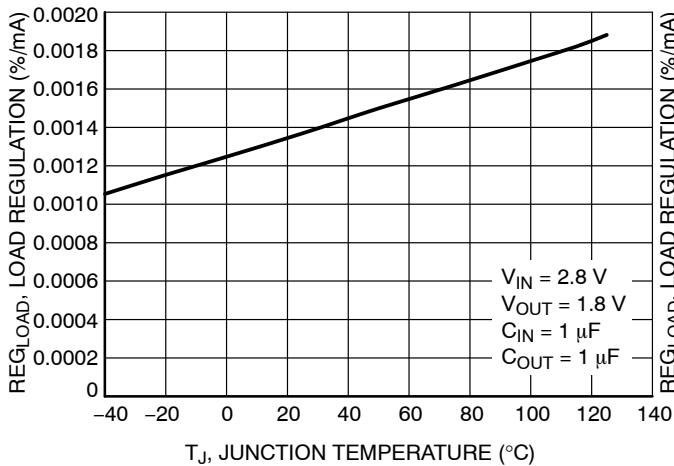

Figure 7. Load Regulation vs. Temperature – $V_{OUT} = 1.8\text{ V}$

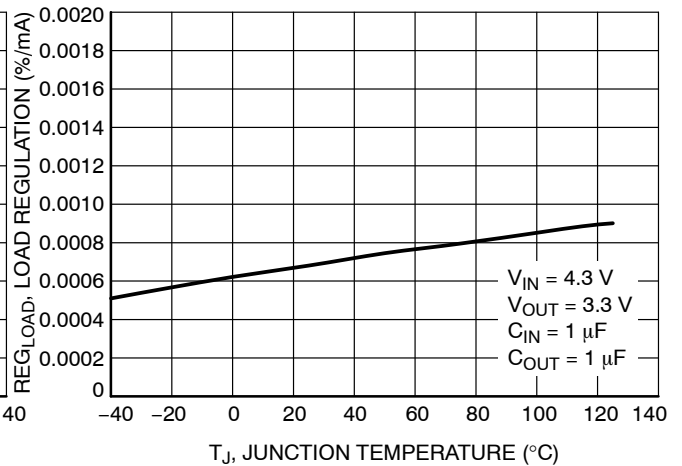

Figure 8. Load Regulation vs. Temperature – $V_{OUT} = 3.3\text{ V}$

TYPICAL CHARACTERISTICS

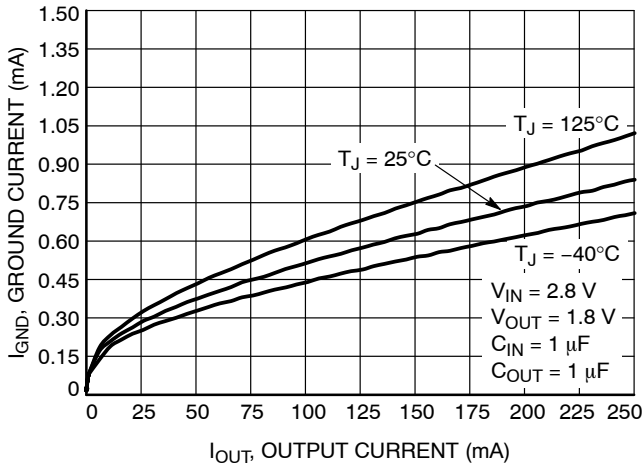

Figure 9. Ground Current vs. Load Current – $V_{OUT} = 1.8\text{ V}$

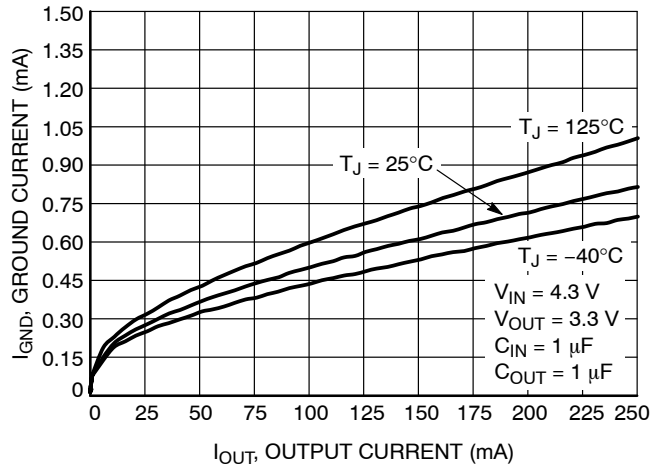

Figure 10. Ground Current vs. Load Current – $V_{OUT} = 3.3\text{ V}$

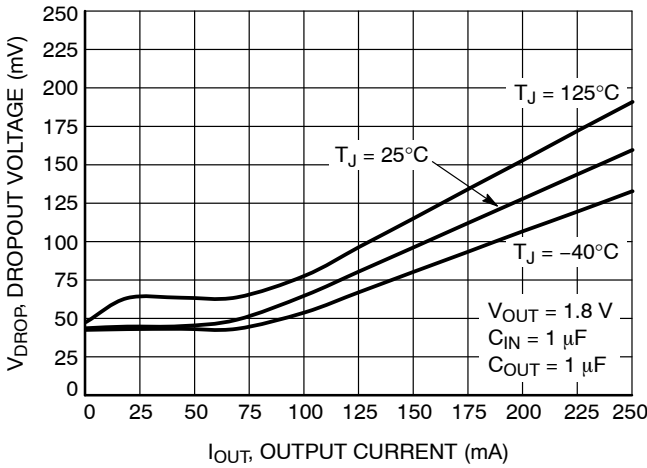

Figure 11. Dropout Voltage vs. Load Current – $V_{OUT} = 1.8\text{ V}$

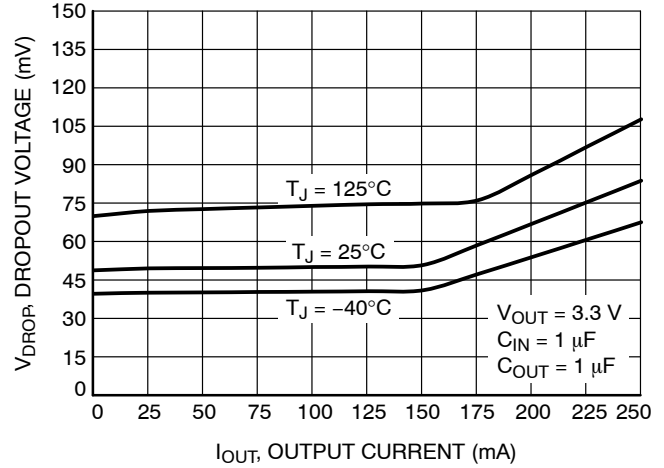

Figure 12. Dropout Voltage vs. Load Current – $V_{OUT} = 3.3\text{ V}$

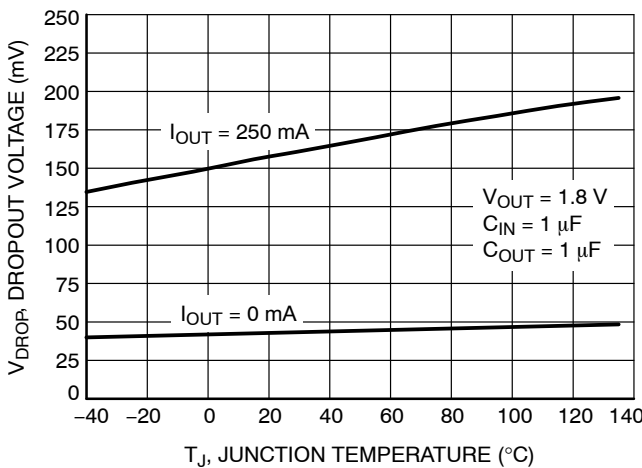

Figure 13. Dropout Voltage vs. Temperature – $V_{OUT} = 1.8\text{ V}$

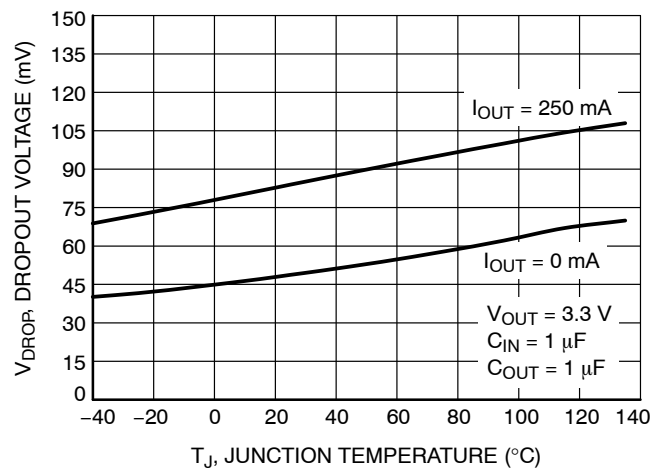

Figure 14. Dropout Voltage vs. Temperature – $V_{OUT} = 3.3\text{ V}$

TYPICAL CHARACTERISTICS

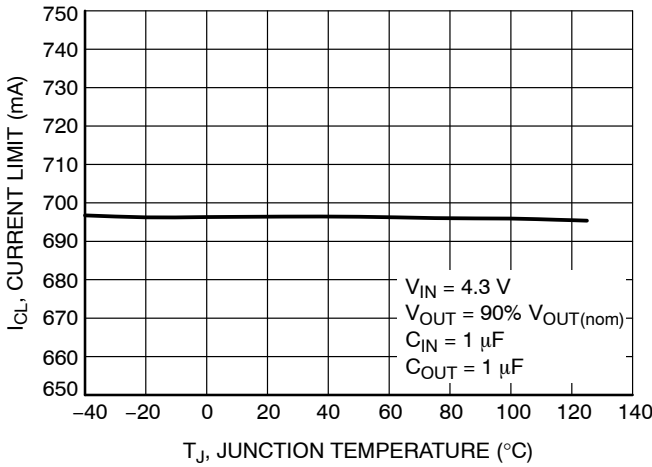

Figure 15. Current Limit vs. Temperature

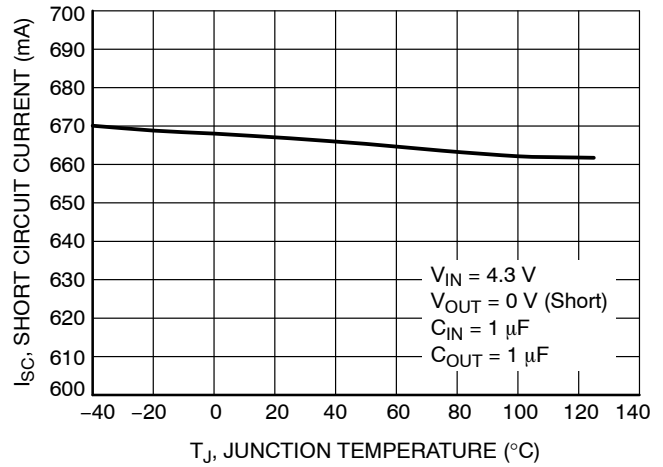

Figure 16. Short Circuit Current vs. Temperature

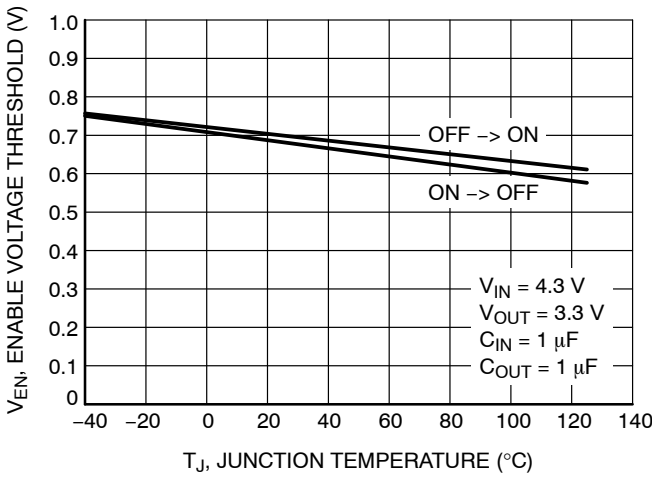

Figure 17. Enable Threshold Voltage vs. Temperature

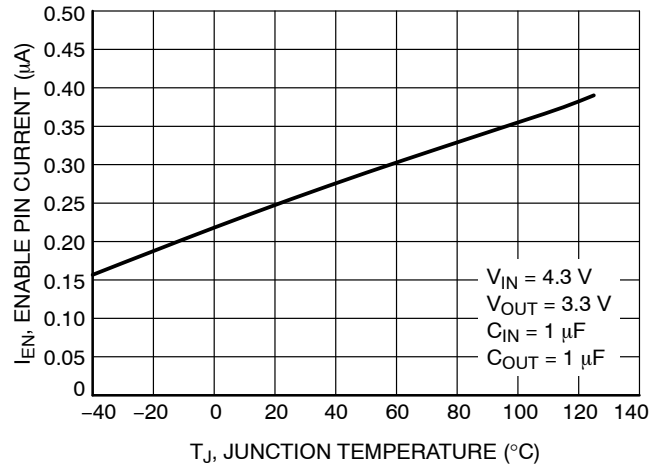

Figure 18. Enable Current Temperature

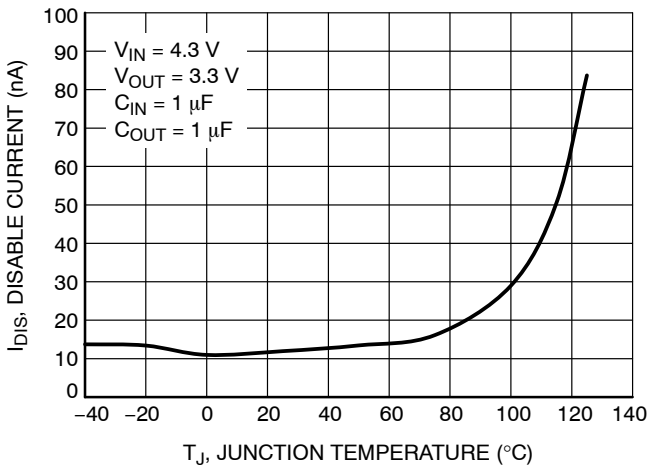

Figure 19. Disable Current vs. Temperature

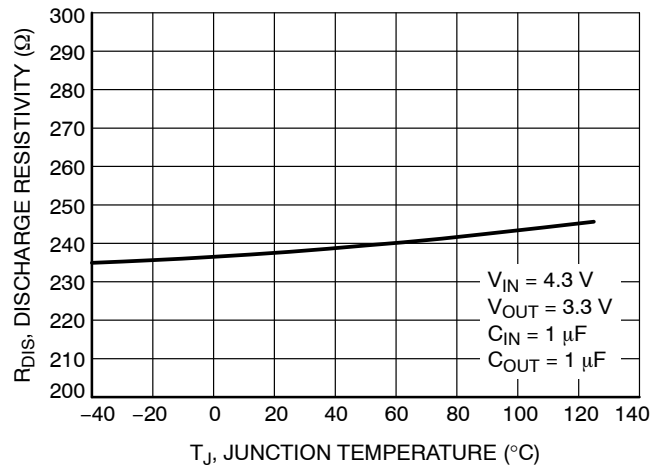
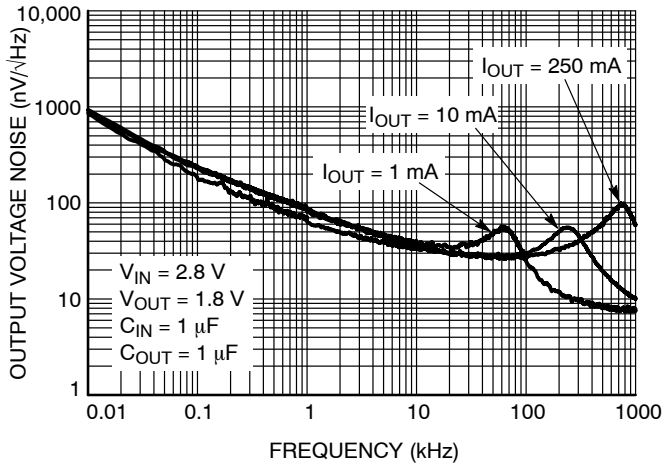

Figure 20. Discharge Resistivity vs. Temperature

TYPICAL CHARACTERISTICS



I _{OUT}	RMS Output Noise (μV)	
	10 Hz – 100 kHz	100 Hz – 100 kHz
1 mA	14.62	14.10
10 mA	11.12	10.48
250 mA	10.37	9.82

Figure 21. Output Voltage Noise Spectral Density – V_{OUT} = 1.8 V

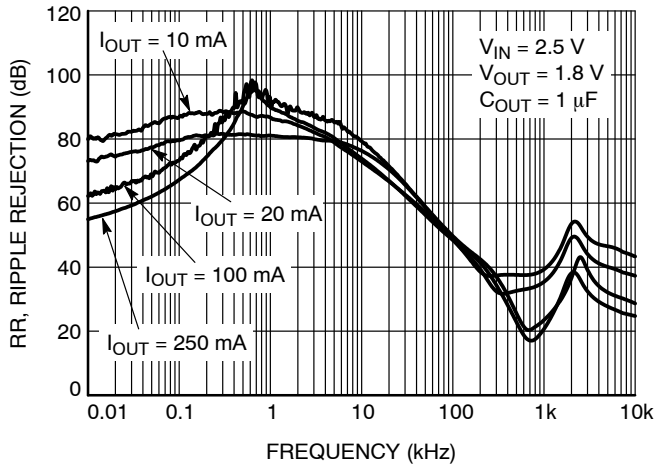

Figure 22. Power Supply Rejection Ratio, V_{OUT} = 1.8 V

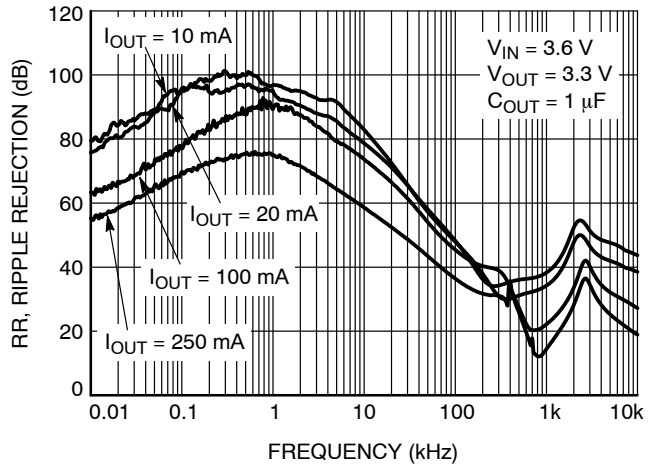

Figure 23. Power Supply Rejection Ratio, V_{OUT} = 3.3 V

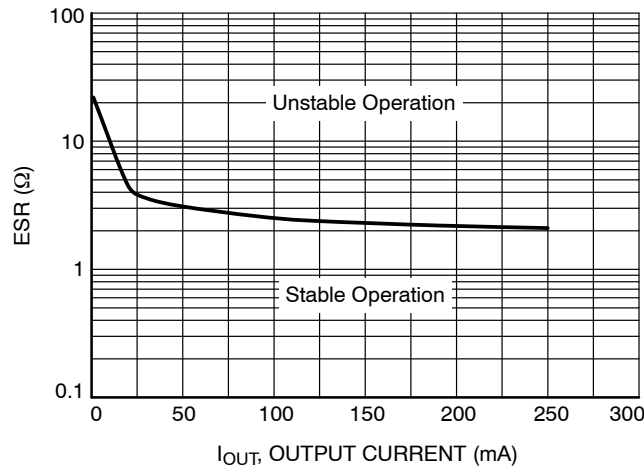

Figure 24. Stability vs. ESR

TYPICAL CHARACTERISTICS

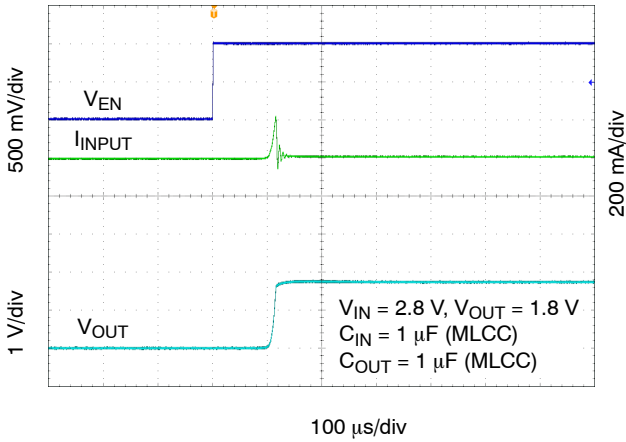

Figure 25. Enable Turn-on Response - $C_{OUT} = 1 \mu\text{F}$, $I_{OUT} = 10 \text{ mA}$

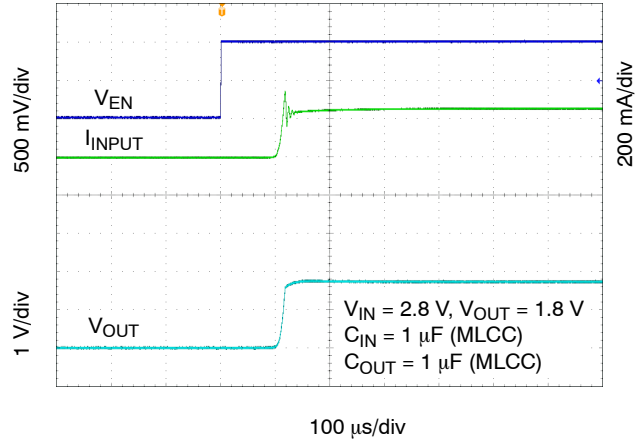

Figure 26. Enable Turn-on Response - $C_{OUT} = 1 \mu\text{F}$, $I_{OUT} = 250 \text{ mA}$

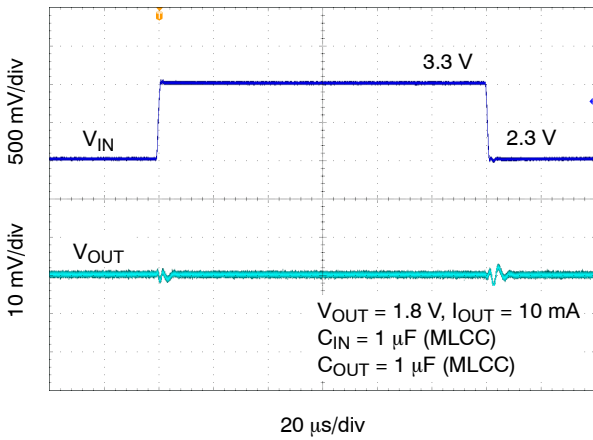

Figure 27. Line Transient Response - $V_{OUT} = 1.8 \text{ V}$

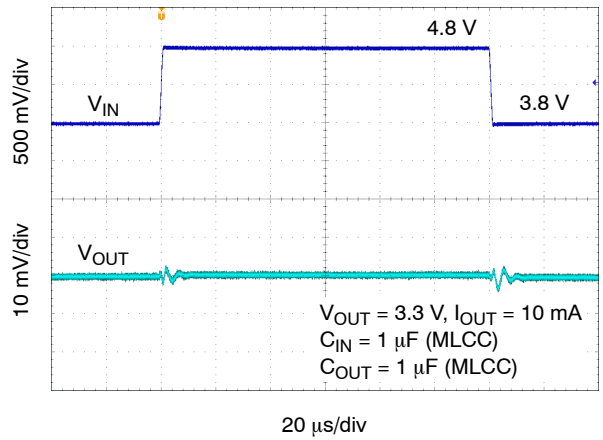

Figure 28. Line Transient Response - $V_{OUT} = 3.3 \text{ V}$

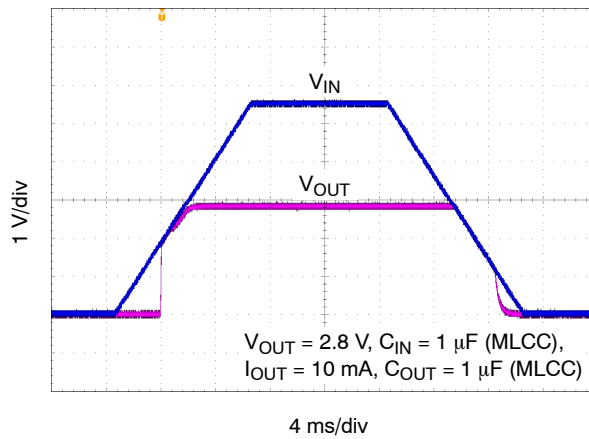

Figure 29. Turn-on/off - Slow Rising V_{IN}

TYPICAL CHARACTERISTICS

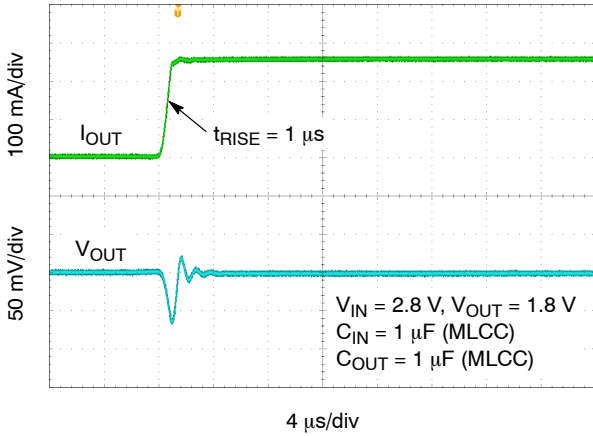

Figure 30. Load Transient Response – 1 mA to 250 mA – $V_{OUT} = 1.8\text{ V}$

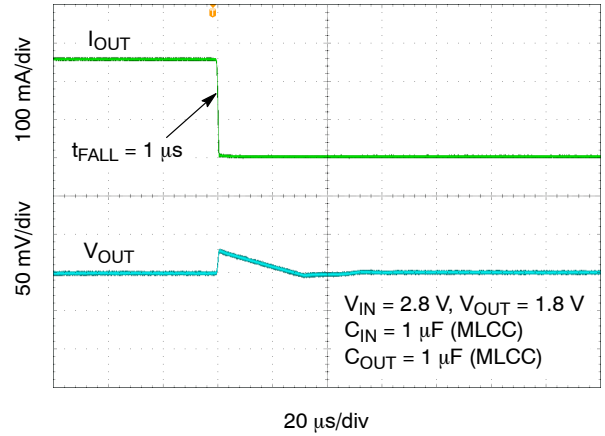

Figure 31. Load Transient Response – 250 mA to 1 mA – $V_{OUT} = 1.8\text{ V}$

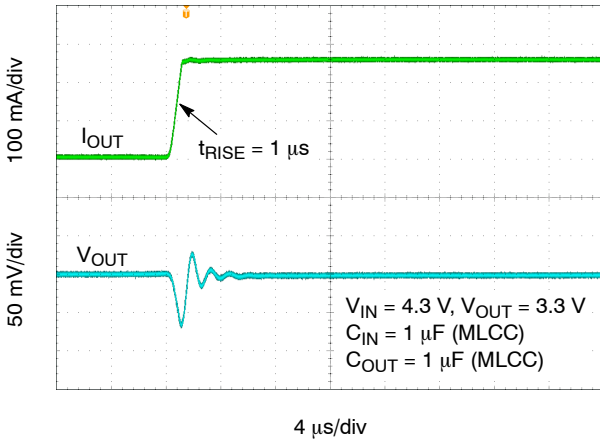

Figure 32. Load Transient Response – 1 mA to 250 mA – $V_{OUT} = 3.3\text{ V}$

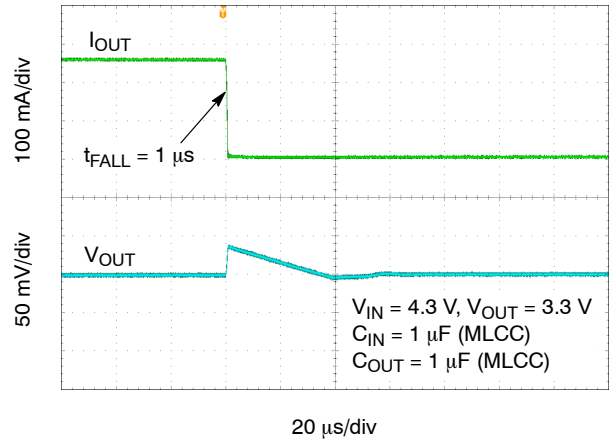

Figure 33. Load Transient Response – 250 mA to 1 mA – $V_{OUT} = 3.3\text{ V}$

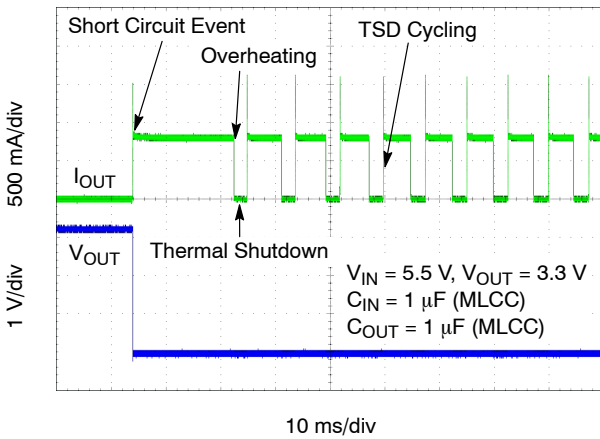

Figure 34. Short Circuit and Thermal Shutdown

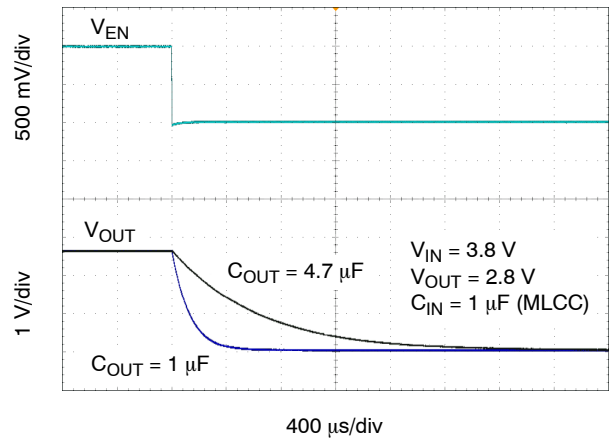

Figure 35. Enable Turn-off

APPLICATIONS INFORMATION

General

The NCV8160 is an ultra–low noise 250 mA low dropout regulator designed to meet the requirements of RF applications and high performance analog circuits. The NCV8160 device provides very high PSRR and excellent dynamic response. In connection with low quiescent current this device is well suitable for battery powered application such as cell phones, tablets and other. The NCV8160 is fully protected in case of current overload, output short circuit and overheating.

Input Capacitor Selection (C_{IN})

Input capacitor connected as close as possible is necessary for ensure device stability. The X7R or X5R capacitor should be used for reliable performance over temperature range. The value of the input capacitor should be 1 μF or greater to ensure the best dynamic performance. This capacitor will provide a low impedance path for unwanted AC signals or noise modulated onto constant input voltage. There is no requirement for the ESR of the input capacitor but it is recommended to use ceramic capacitors for their low ESR and ESL. A good input capacitor will limit the influence of input trace inductance and source resistance during sudden load current changes.

Output Decoupling (C_{OUT})

The NCV8160 requires an output capacitor connected as close as possible to the output pin of the regulator. The recommended capacitor value is 1 μF and X7R or X5R dielectric due to its low capacitance variations over the specified temperature range. The NCV8160 is designed to remain stable with minimum effective capacitance of 0.7 μF to account for changes with temperature, DC bias and package size. Especially for small package size capacitors such as 0201 the effective capacitance drops rapidly with the applied DC bias. Please refer Figure 36.

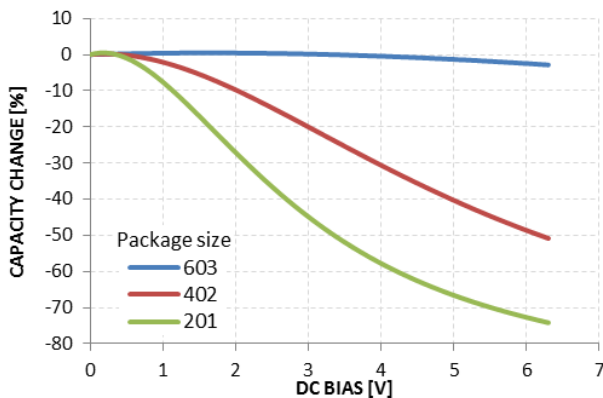

Figure 36. Capacity vs DC Bias Voltage

There is no requirement for the minimum value of Equivalent Series Resistance (ESR) for the C_{OUT} but the maximum value of ESR should be less than 2 Ω. Larger output capacitors and lower ESR could improve the load

transient response or high frequency PSRR. It is not recommended to use tantalum capacitors on the output due to their large ESR. The equivalent series resistance of tantalum capacitors is also strongly dependent on the temperature, increasing at low temperature.

Enable Operation

The NCV8160 uses the EN pin to enable/disable its device and to deactivate/activate the active discharge function.

If the EN pin voltage is <0.4 V the device is guaranteed to be disabled. The pass transistor is turned–off so that there is virtually no current flow between the IN and OUT. The active discharge transistor is active so that the output voltage V_{OUT} is pulled to GND through a 280 Ω resistor. In the disable state the device consumes as low as typ. 10 nA from the V_{IN}.

If the EN pin voltage >1.2 V the device is guaranteed to be enabled. The NCV8160 regulates the output voltage and the active discharge transistor is turned–off.

The EN pin has internal pull–down current source with typ. value of 200 nA which assures that the device is turned–off when the EN pin is not connected. In the case where the EN function isn’t required the EN should be tied directly to IN.

Output Current Limit

Output Current is internally limited within the IC to a typical 700 mA. The NCP60 will source this amount of current measured with a voltage drops on the 90% of the nominal V_{OUT}. If the Output Voltage is directly shorted to ground (V_{OUT} = 0 V), the short circuit protection will limit the output current to 690 mA (typ). The current limit and short circuit protection will work properly over whole temperature range and also input voltage range. There is no limitation for the short circuit duration.

Thermal Shutdown

When the die temperature exceeds the Thermal Shutdown threshold (T_{SD} – 160°C typical), Thermal Shutdown event is detected and the device is disabled. The IC will remain in this state until the die temperature decreases below the Thermal Shutdown Reset threshold (T_{SDU} – 140°C typical). Once the IC temperature falls below the 140°C the LDO is enabled again. The thermal shutdown feature provides the protection from a catastrophic device failure due to accidental overheating. This protection is not intended to be used as a substitute for proper heat sinking.

Power Dissipation

As power dissipated in the NCV8160 increases, it might become necessary to provide some thermal relief. The maximum power dissipation supported by the device is dependent upon board design and layout. Mounting pad configuration on the PCB, the board material, and the ambient temperature affect the rate of junction temperature

NCV8160

rise for the part. For reliable operation, junction temperature should be limited to +125°C.

The maximum power dissipation the NCV8160 can handle is given by:

$$P_{D(MAX)} = \frac{[125^{\circ}\text{C} - T_A]}{\theta_{JA}} \quad (\text{eq. 1})$$

The power dissipated by the NCV8160 for given application conditions can be calculated from the following equations:

$$P_D \approx V_{IN} \cdot I_{GND} + I_{OUT}(V_{IN} - V_{OUT}) \quad (\text{eq. 2})$$

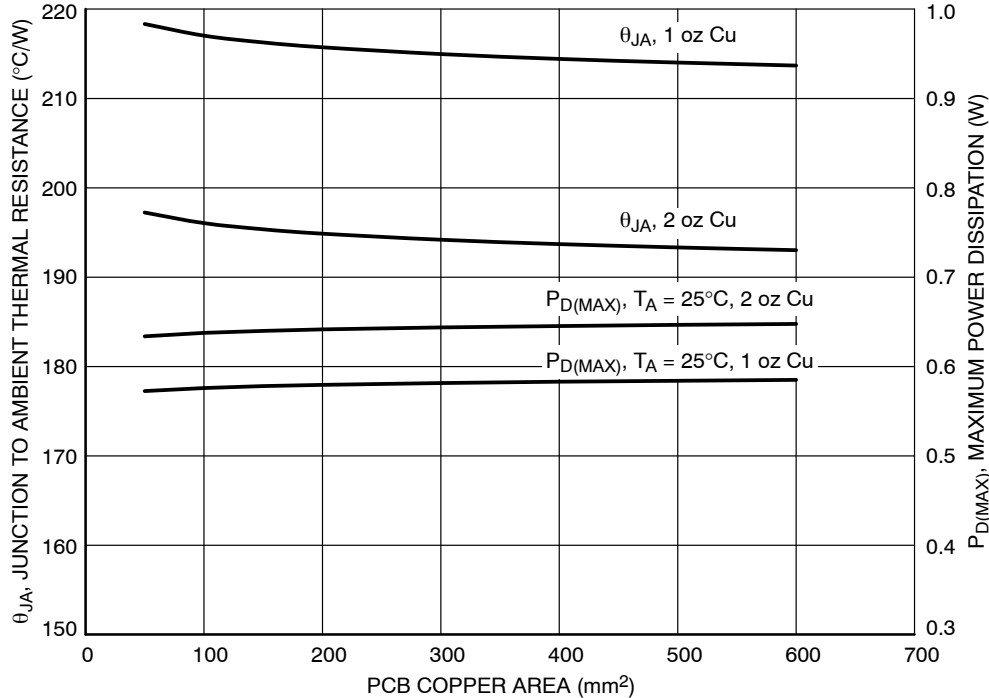

Figure 37. θ_{JA} and $P_{D(MAX)}$ vs. Copper Area

Reverse Current

The PMOS pass transistor has an inherent body diode which will be forward biased in the case that $V_{OUT} > V_{IN}$. Due to this fact in cases, where the extended reverse current condition can be anticipated the device may require additional external protection.

Power Supply Rejection Ratio

The NCV8160 features very high Power Supply Rejection ratio. If desired the PSRR at higher frequencies in the range 100 kHz – 10 MHz can be tuned by the selection of C_{OUT} capacitor and proper PCB layout.

Turn-On Time

The turn-on time is defined as the time period from EN assertion to the point in which V_{OUT} will reach 98% of its nominal value. This time is dependent on various application conditions such as $V_{OUT(NOM)}$, C_{OUT} , T_A .

PCB Layout Recommendations

To obtain good transient performance and good regulation characteristics place C_{IN} and C_{OUT} capacitors close to the device pins and make the PCB traces wide. In order to minimize the solution size, use 0402 or 0201 capacitors with appropriate capacity. Larger copper area connected to the pins will also improve the device thermal resistance. The actual power dissipation can be calculated from the equation above (Equation 2). Expose pad can be tied to the GND pin for improvement power dissipation and lower device temperature.

NCV8160

ORDERING INFORMATION

Device	Nominal Output Voltage	Description	Marking	Package	Shipping [†]
NCV8160AMX180TBG (Note 7)	1.8 V	250 mA, Active Discharge	DF	XDFN4 (Pb-Free)	3000 or 5000 / Tape & Reel (Note 7)
NCV8160AMX250TBG (Note 7)	2.5 V		DG		
NCV8160AMX280TBG (Note 7)	2.8 V		DH		
NCV8160AMX290TBG (Note 7)	2.9 V		D4		
NCV8160AMX300TBG (Note 7)	3.0 V		DK		
NCV8160AMX330TBG (Note 7)	3.3 V		DA		
NCV8160AMX500TBG	5.0 V		DW		
NCV8160BMX180TBG	1.8 V	250 mA, Non-Active Discharge	EF		
NCV8160BMX250TBG	2.5 V		EG		
NCV8160BMX280TBG	2.8 V		EH		
NCV8160BMX300TBG	3.0 V		EK		
NCV8160BMX330TBG	3.3 V		EA		
NCV8160BMX500TBG	5.0 V		EW		

[†]For information on tape and reel specifications, including part orientation and tape sizes, please refer to our Tape and Reel Packaging Specifications Brochure, BRD8011/D.

7. Products processed after October 1, 2022 are shipped with quantity 5000 units / tape & reel.

Bluetooth is a registered trademark of Bluetooth SIG.
ZigBee is a registered trademark of ZigBee Alliance.

MECHANICAL CASE OUTLINE PACKAGE DIMENSIONS



XDFN4 1.0x1.0, 0.65P
CASE 711AJ
ISSUE C

DATE 08 MAR 2022

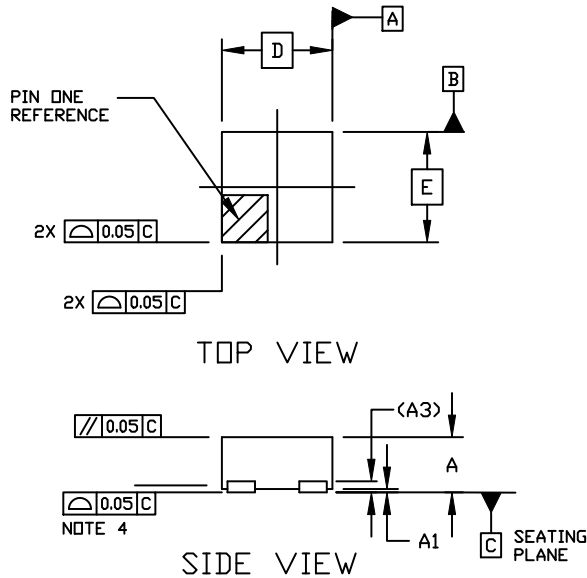

NOTES:

1. DIMENSIONING AND TOLERANCING PER ASME Y14.5M, 1994.
2. CONTROLLING DIMENSION: MILLIMETERS
3. DIMENSION *b* APPLIES TO THE PLATED TERMINALS AND IS MEASURED BETWEEN 0.15 AND 0.20 FROM THE TERMINAL TIPS.
4. COPLANARITY APPLIES TO THE EXPOSED PAD AS WELL AS THE TERMINALS.

DIM	MILLIMETERS		
	MIN	NOM	MAX
A	0.33	0.38	0.43
A1	0.00	---	0.05
A3	0.10 REF		
<i>b</i>	0.15	0.20	0.25
<i>b</i> 2	0.02	0.07	0.12
D	0.90	1.00	1.10
D2	0.43	0.48	0.53
E	0.90	1.00	1.10
<i>e</i>	0.65 BSC		
L	0.20		0.30
L2	0.07		0.17

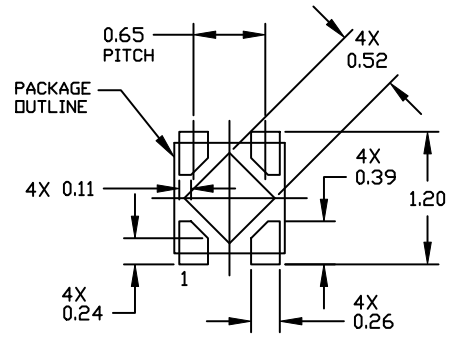
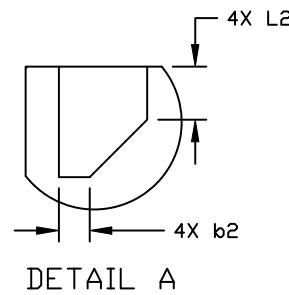
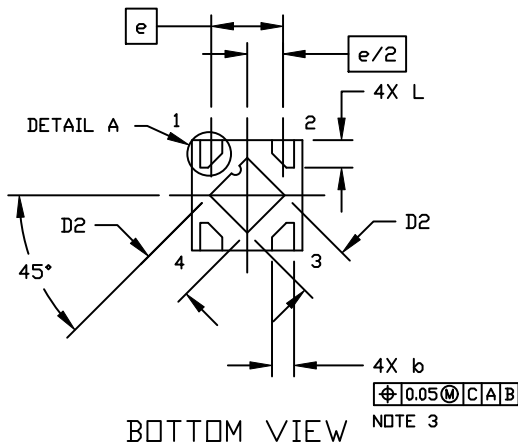

**RECOMMENDED
MOUNTING FOOTPRINT**

* FOR ADDITIONAL INFORMATION ON OUR Pb-FREE STRATEGY AND SOLDERING DETAILS, PLEASE DOWNLOAD THE ONSEMI SOLDERING AND MOUNT TECHNIQUES REFERENCE MANUAL, SOLDERRM/D

**GENERIC
MARKING DIAGRAM***

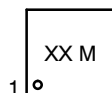

XX = Specific Device Code
M = Date Code

*This information is generic. Please refer to device data sheet for actual part marking. Pb-Free indicator, "G" or microdot "•", may or may not be present. Some products may not follow the Generic Marking.

DOCUMENT NUMBER:	98AON67179E	Electronic versions are uncontrolled except when accessed directly from the Document Repository. Printed versions are uncontrolled except when stamped "CONTROLLED COPY" in red.
DESCRIPTION:	XDFN4, 1.0X1.0, 0.65P	PAGE 1 OF 1

onsemi and ONSEMI are trademarks of Semiconductor Components Industries, LLC dba onsemi or its subsidiaries in the United States and/or other countries. onsemi reserves the right to make changes without further notice to any products herein. onsemi makes no warranty, representation or guarantee regarding the suitability of its products for any particular purpose, nor does onsemi assume any liability arising out of the application or use of any product or circuit, and specifically disclaims any and all liability, including without limitation special, consequential or incidental damages. onsemi does not convey any license under its patent rights nor the rights of others.

onsemi, **Onsemi**, and other names, marks, and brands are registered and/or common law trademarks of Semiconductor Components Industries, LLC dba "**onsemi**" or its affiliates and/or subsidiaries in the United States and/or other countries. **onsemi** owns the rights to a number of patents, trademarks, copyrights, trade secrets, and other intellectual property. A listing of **onsemi**'s product/patent coverage may be accessed at www.onsemi.com/site/pdf/Patent-Marking.pdf. **onsemi** reserves the right to make changes at any time to any products or information herein, without notice. The information herein is provided "as-is" and **onsemi** makes no warranty, representation or guarantee regarding the accuracy of the information, product features, availability, functionality, or suitability of its products for any particular purpose, nor does **onsemi** assume any liability arising out of the application or use of any product or circuit, and specifically disclaims any and all liability, including without limitation special, consequential or incidental damages. Buyer is responsible for its products and applications using **onsemi** products, including compliance with all laws, regulations and safety requirements or standards, regardless of any support or applications information provided by **onsemi**. "Typical" parameters which may be provided in **onsemi** data sheets and/or specifications can and do vary in different applications and actual performance may vary over time. All operating parameters, including "Typicals" must be validated for each customer application by customer's technical experts. **onsemi** does not convey any license under any of its intellectual property rights nor the rights of others. **onsemi** products are not designed, intended, or authorized for use as a critical component in life support systems or any FDA Class 3 medical devices or medical devices with a same or similar classification in a foreign jurisdiction or any devices intended for implantation in the human body. Should Buyer purchase or use **onsemi** products for any such unintended or unauthorized application, Buyer shall indemnify and hold **onsemi** and its officers, employees, subsidiaries, affiliates, and distributors harmless against all claims, costs, damages, and expenses, and reasonable attorney fees arising out of, directly or indirectly, any claim of personal injury or death associated with such unintended or unauthorized use, even if such claim alleges that **onsemi** was negligent regarding the design or manufacture of the part. **onsemi** is an Equal Opportunity/Affirmative Action Employer. This literature is subject to all applicable copyright laws and is not for resale in any manner.

ADDITIONAL INFORMATION

TECHNICAL PUBLICATIONS:

Technical Library: www.onsemi.com/design/resources/technical-documentation
onsemi Website: www.onsemi.com

ONLINE SUPPORT: www.onsemi.com/support

For additional information, please contact your local Sales Representative at www.onsemi.com/support/sales

