

Synchronous Buck Converter - Step Down

3.0 A

NCP6343

The NCP6343 is a synchronous buck converter optimized to supply the different sub systems of portable applications powered by one cell Li-Ion or three cell Alkaline/NiCd/NiMH batteries. The device is able to deliver up to 3.0 A, with programmable output voltage from 0.6 V to 1.4 V. It can share the same output rail with another DCDC and works as a transient load helper. Operation at a 3 MHz switching frequency allows the use of small components. Synchronous rectification and automatic PWM/PFM transitions improve overall solution efficiency. The NCP6343 is in a space saving, low profile 1.99 x 1.34 mm CSP-15 package.

Features

- Input Voltage Range from 2.3 V to 5.5 V: Battery and 5 V Rail Powered Applications
- Programmable Output Voltage: 0.6 V to 1.4 V in 6.25 mV Steps
- Modular Output Stage Drive Strength for Increased Efficiency Depending on the Output Current
- 3 MHz Switching Frequency with On Chip Oscillator
- Uses 470 nH Inductor and 22 μ F Capacitors for Optimized Footprint and Solution Thickness
- PFM/PWM Operation for Optimum Increased Efficiency
- Ultra Low 0.8 μ A Off Mode Current
- Low 35 μ A Quiescent Current
- I²C Control Interface with Interrupt and Dynamic Voltage Scaling Support
- Thermal Protections and Temperature Management
- Transient Load Helper: Share the Same Rail with Another DCDC
- Small 1.99 x 1.34 mm / 0.4 mm Pitch CSP Package
- These are Pb-Free Devices

Typical Applications

- Smartphones
- Webtablets

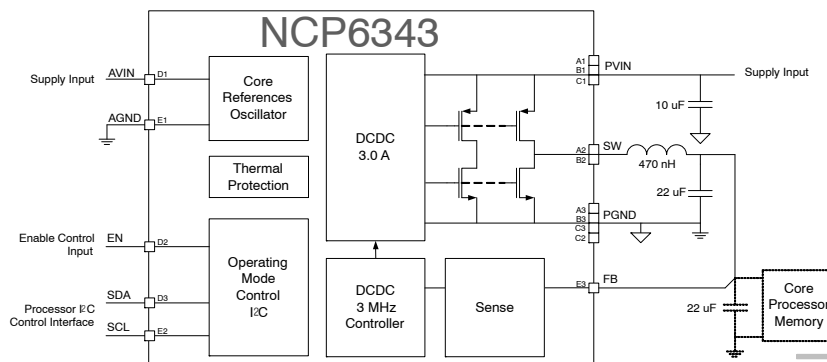

Figure 1. Typical Application Circuit



ON Semiconductor®

www.onsemi.com



WLCSP15
CASE 567GB

MARKING DIAGRAM

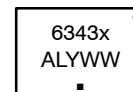

- x = P: Prototype
- = Blank: 1.225 V – 2.0 A
- = A: 1.225 V – 3.0 A
- = B: 1.225 V – 3.0 A
- = D: 1.18125 V – 3.0 A
- = M: 0.925 V – 3.0 A
- = S: 1.050 V – 3.0 A
- = V: 1.225 V – 3.0 A
- = X: 1.225 V – 3.0 A
- A = Assembly Location
- L = Wafer Lot
- Y = Year
- WW = Work Week
- = Pb-Free Package

Pb-Free indicator, G or microdot (▪), may or may not be present

PINOUT DIAGRAM

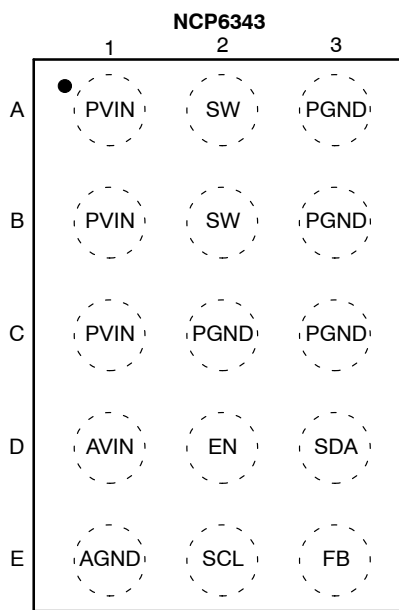

(Top View)
15-Pin 0.40 mm pitch WLCSP

ORDERING INFORMATION

See detailed ordering and shipping information on page 30 of this data sheet.

NCP6343

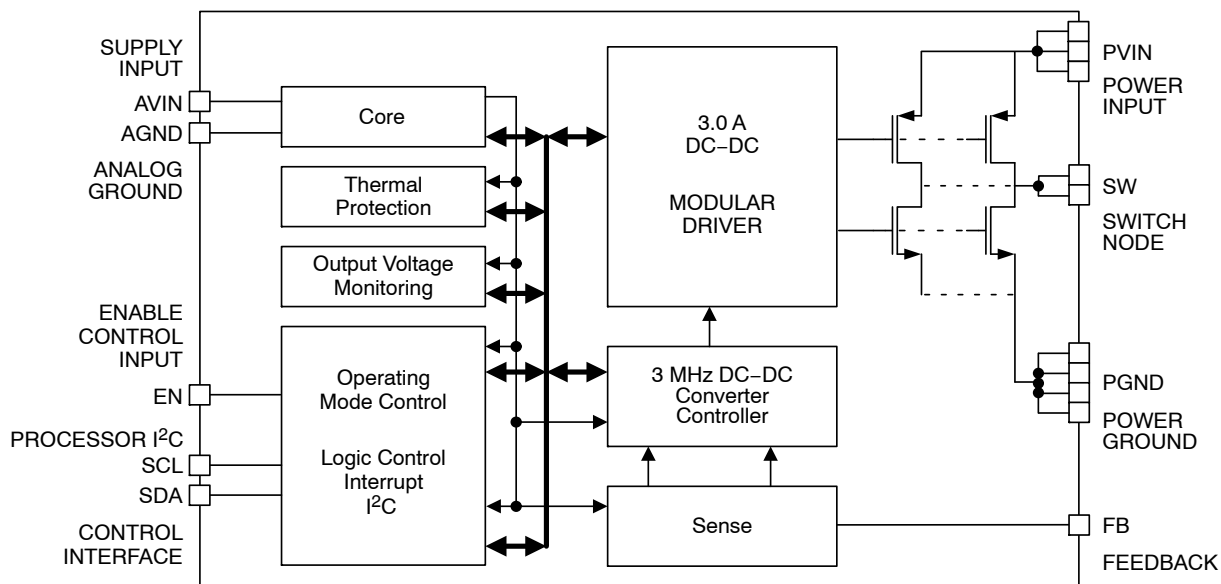

Figure 2. Simplified Block Diagram

NCP6343

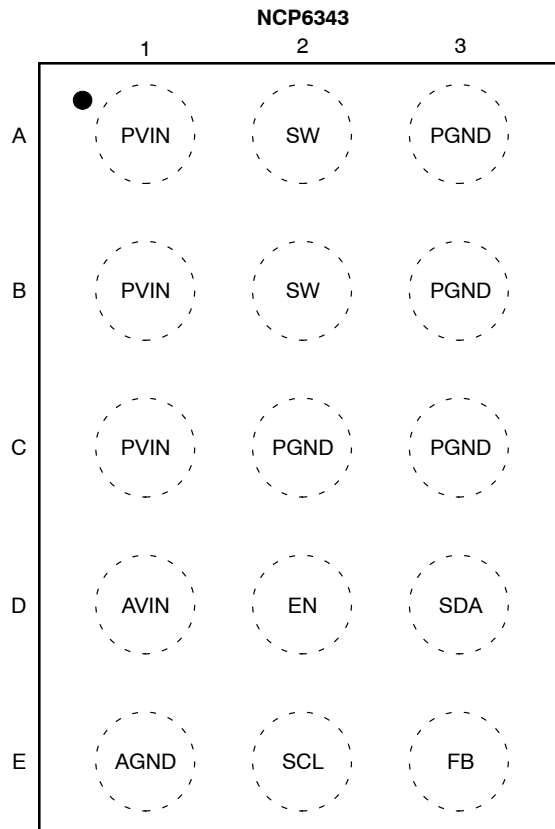

Figure 3. Pin Out (Top View)

Table 1. PIN FUNCTION DESCRIPTION

Pin	Name	Type	Description
REFERENCE			
D1	AVIN	Analog Input	Analog Supply. This pin is the device analog and digital supply. Could be connected directly to the VIN plane or to a dedicated 1.0 μ F ceramic capacitor. Must be equal to PVIN.
E1	AGND	Analog Ground	Analog Ground. Analog and digital modules ground. Must be connected to the system ground.
CONTROL AND SERIAL INTERFACE			
D2	EN	Digital Input	Enable Control. Active high will enable the part. Do not leave this pin floating.
E2	SCL	Digital Input	I ² C interface Clock line. There is an internal pull down resistor on this pin; could be left open if not used
D3	SDA	Digital Input/Output	I ² C interface Bi-directional Data line. There is an internal pull down resistor on this pin; could be left open if not used
DCDC CONVERTER			
A1, B1, C1	PVIN	Power Input	Switch Supply. These pins must be decoupled to ground by a 10 μ F ceramic capacitor. It should be placed as close as possible to these pins. All pins must be used with short heavy connections. Must be equal to AVIN.
A2, B2	SW	Power Output	Switch Node. These pins supply drive power to the inductor. Typical application uses 0.470 μ H inductor; refer to application section for more information. All pins must be used with short heavy connections.
A3, B3, C3, C2	PGND	Power Ground	Switch Ground. This pin is the power ground and carries the high switching current. High quality ground must be provided to prevent noise spikes. To avoid high-density current flow in a limited PCB track, a local ground plane that connects all PGND pins together is recommended. Analog and power grounds should only be connected together in one location with a trace.
E3	FB	Analog Input	Feedback Voltage input. Must be connected to the output capacitor positive terminal with a trace, not to a plane. This is the positive input to the error amplifier.

NCP6343

Table 2. MAXIMUM RATINGS

Rating	Symbol	Value	Unit
Analog and power pins: AVIN, PVIN, SW, FB	V _A	-0.3 to + 6.0	V
Digital pins: SCL, SDA, EN: Input Voltage Input Current	V _{DG} I _{DG}	-0.3 to V _A + 0.3 ≤ 6.0 10	V mA
Human Body Model (HBM) ESD Rating (Note 1)	ESD HBM	2000	V
Machine Model (MM) ESD Rating (Note 1)	ESD MM	150	V
Charged Device Model (CDM) ESD Rating (Note 1)	ESD CDM	2000	V
Latch Up Current: (Note 2) Digital Pins All Other Pins	I _{LU}	±10 ±100	mA
Storage Temperature Range	T _{STG}	-65 to + 150	°C
Maximum Junction Temperature	T _{JMAX}	-40 to +150	°C
Moisture Sensitivity (Note 3)	MSL	Level 1	

Stresses exceeding those listed in the Maximum Ratings table may damage the device. If any of these limits are exceeded, device functionality should not be assumed, damage may occur and reliability may be affected.

- This device series contains ESD protection and passes the following ratings:
Human Body Model (HBM) ±2.0 kV per JEDEC standard: JESD22-A114.
Machine Model (MM) ±150 V per JEDEC standard: JESD22-A115.
Charged Device Model (CDM) ±2.0 kV per JEDEC standard: JESD22-C101 Class IV.
- Latch up Current per JEDEC standard: JESD78 class II.
- Moisture Sensitivity Level (MSL): 1 per IPC/JEDEC standard: J-STD-020A.

Table 3. OPERATING CONDITIONS (Note 4)

Symbol	Parameter	Conditions	Min	Typ	Max	Unit
AV _{IN} , PV _{IN}	Power Supply	AVIN = PVIN	2.3		5.5	V
T _A	Ambient Temperature Range		-40	25	+85	°C
T _J	Junction Temperature Range (Note 5)		-40	25	+125	°C
R _{θJA}	Thermal Resistance Junction to Ambient (Note 6)	CSP-15 on Demo-board	-	65	-	°C/W
P _D	Power Dissipation Rating (Note 7)	T _A ≤ 85°C	-	615	-	mW
P _D	Power Dissipation Rating (Note 7)	T _A = 65°C	-	923	-	mW
L	Inductor for DCDC converter (Note 4)		-	0.47	-	μH
Co	Output Capacitor for DCDC Converter (Note 4)		28	-	55	μF
Cin	Input Capacitor for DCDC Converter (Note 4)		4.7	-	-	μF

- Including de-ratings (Refer to the Application Information section of this document for further details)
- The thermal shutdown set to 150°C (typical) avoids potential irreversible damage on the device due to power dissipation.
- The R_{θJA} is dependent of the PCB heat dissipation.
- The maximum power dissipation (P_D) is dependent by input voltage, maximum output current and external components selected.

$$R_{\theta JA} = \frac{125 - T_A}{P_D}$$

NCP6343

Table 4. ELECTRICAL CHARACTERISTICS (Note 9)

Min and Max Limits apply for $T_A = -40^{\circ}\text{C}$ to $+85^{\circ}\text{C}$, $V_{IN} = PV_{IN} = 3.6\text{ V}$ and default configuration, unless otherwise specified. Typical values are referenced to $T_A = +25^{\circ}\text{C}$, $V_{IN} = PV_{IN} = 3.6\text{ V}$ and default configuration, unless otherwise specified.

Symbol	Parameter	Conditions	Min	Typ	Max	Unit
--------	-----------	------------	-----	-----	-----	------

SUPPLY CURRENT: Pins AVIN – PVINx

$I_{Q\text{ PWM}}$	Operating quiescent current PWM	DCDC active in Forced PWM no load	–	12	20	mA
$I_{Q\text{ PFM}}$	Operating quiescent current PFM	DCDC active in Auto mode no load – minimal switching	–	35	70	μA
I_{SLEEP}	Product sleep mode current	EN high, DCDC off or EN low and Sleep_Mode high $V_{IN} = 2.5\text{ V}$ to 5.5 V	–	7	15	μA
I_{OFF}	Product in off mode	EN and Sleep_Mode low $V_{IN} = 2.5\text{ V}$ to 5.5 V (All other parts) (NCP6343XFCCT1G)	– –	0.8 7	5 15	μA

DCDC CONVERTER

PV_{IN}	Input Voltage Range		2.3	–	5.5	V
I_{OUTMAX}	Maximum Output Current	$I_{\text{peak}}[1..0] = 00/01$ (Note 10)	2.0	–	–	A
		$I_{\text{peak}}[1..0] = 10$ (Note 10)	2.5	–	–	
		$I_{\text{peak}}[1..0] = 11$ (Note 10)	3.0	–	–	
ΔV_{OUT}	Output Voltage DC Error	Forced PWM mode No load	–1	–	1	%
		Forced PWM mode, V_{IN} range, I_{OUT} up to I_{OUTMAX} (Note 10)	–1	–	1	
		Auto mode, V_{IN} range, I_{OUT} up to I_{OUTMAX} (Note 10)	–1	–	2	
F_{SW}	Switching Frequency		2.7	3	3.3	MHz
R_{ONHS}	P-Channel MOSFET On Resistance	From PV_{IN} to SW (all Modules) $V_{IN} = 5.0\text{ V}$	–	36	64	$\text{m}\Omega$
R_{ONLS}	N-Channel MOSFET On Resistance	From SW to PGND (all Modules) $V_{IN} = 5.0\text{ V}$	–	19	40	$\text{m}\Omega$
I_{PK}	Peak Inductor Current	Open loop – $I_{\text{peak}}[1..0] = 00/01$	2.5	2.9	3.3	A
		Open loop – $I_{\text{peak}}[1..0] = 10$	3.0	3.4	3.8	
		Open loop – $I_{\text{peak}}[1..0] = 11$	3.5	3.9	4.3	
DC_{LOAD}	Load Regulation	I_{OUT} from 0 A to I_{OUTMAX} (Note 10)	–	–0.2	–	%/A
DC_{LINE}	Line Regulation	$I_{\text{OUT}} = 3\text{ A}$ $2.3\text{ V} \leq V_{IN} \leq 5.5\text{ V}$ (Note 10)	–	0	–	%
AC_{LOAD}	Transient Load Response	$t_r = t_s = 100\text{ ns}$ Load step 1.3 A (Note 10)	–	± 50	–	mV
AC_{LINE}	Transient Line Response	$t_r = t_s = 10\text{ }\mu\text{s}$ 100 mA Load (Note 10)		± 30		mV
D	Maximum Duty Cycle		–	100	–	%
t_{START}	Turn on time	Time from EN transitions from Low to High to 95% of Output Voltage (DELAY[2..0] = 000b and DVSup = 0)	–	80	100	μs
t_{START}	Turn on time	Time from EN transitions from Low to High to 95% of Output Voltage (DELAY[2..0] = 000b and DVSup = 1)	–	425	550	μs
R_{DISDCDC}	DCDC Active Output Discharge	$V_{\text{out}} = 1.225\text{ V}$	–	25	35	Ω

8. Devices that use non-standard supply voltages which do not conform to the intent I²C bus system levels must relate their input levels to the V_{DD} voltage to which the pull-up resistors R_P are connected.

9. Refer to the Application Information section of this data sheet for more details.

10. Guaranteed by design and characterized.

NCP6343

Table 4. ELECTRICAL CHARACTERISTICS (Note 9)

Min and Max Limits apply for $T_A = -40^{\circ}\text{C}$ to $+85^{\circ}\text{C}$, $AVIN = PVIN = 3.6\text{ V}$ and default configuration, unless otherwise specified. Typical values are referenced to $T_A = +25^{\circ}\text{C}$, $AVIN = PVIN = 3.6\text{ V}$ and default configuration, unless otherwise specified.

Symbol	Parameter	Conditions	Min	Typ	Max	Unit
--------	-----------	------------	-----	-----	-----	------

EN

V_{IH}	High input voltage		1.05	–	–	V
V_{IL}	Low input voltage		–	–	0.4	V
T_{FTR}	Digital input X Filter	EN rising and falling DBN_Time = 01 (Note 10)	0.5	–	4.5	μs
I_{PD}	Digital input X Pull-Down (input bias current)		–	0.05	1.00	μA

I²C

V_{I^2CINT}	High level at SCL/SCA line		1.7	–	5.0	V
V_{I^2CIL}	SCL, SDA low input voltage	SCL, SDA pin (Notes 8, 10)	–	–	0.5	V
V_{I^2CIH}	SCL, SDA high input voltage	SCL, SDA pin (Notes 8, 10)	0.8 * V_{I^2CINT}	–	–	V
V_{I^2COL}	SDA low output voltage	$I_{SINK} = 3\text{ mA}$ (Note 10)	–	–	0.4	V
F_{SCL}	I ² C clock frequency	(Note 10)	–	–	3.4	MHz

TOTAL DEVICE

V_{UVLO}	Under Voltage Lockout	V_{IN} falling	–	–	2.3	V
V_{UVLOH}	Under Voltage Lockout Hysteresis	V_{IN} rising	60	–	200	mV
T_{SD}	Thermal Shut Down Protection		–	150	–	$^{\circ}\text{C}$
$T_{WARNING}$	Warning Rising Edge		–	135	–	$^{\circ}\text{C}$
T_{PWTH}	Pre – Warning Threshold	I ² C default value	–	105	–	$^{\circ}\text{C}$
T_{SDH}	Thermal Shut Down Hysteresis		–	30	–	$^{\circ}\text{C}$
$T_{WARNINGH}$	Thermal warning Hysteresis		–	15	–	$^{\circ}\text{C}$
$T_{PWTH H}$	Thermal pre-warning Hysteresis		–	6	–	$^{\circ}\text{C}$

8. Devices that use non-standard supply voltages which do not conform to the intent I²C bus system levels must relate their input levels to the V_{DD} voltage to which the pull-up resistors R_P are connected.

9. Refer to the Application Information section of this data sheet for more details.

10. Guaranteed by design and characterized.

NCP6343

TYPICAL OPERATING CHARACTERISTICS $AV_{IN} = PV_{IN} = 3.6\text{ V}$, $T_J = +25^\circ\text{C}$

DCDC = 1.225 V, $I_{\text{peak}} = 3.9\text{ A}$ (Unless otherwise noted). $L = 0.47\ \mu\text{H}$ PIFE20161B – $C_{\text{out}} = 2 \times 22\ \mu\text{F}$ 0603, $C_{\text{in}} = 4.7\ \mu\text{F}$ 0603.

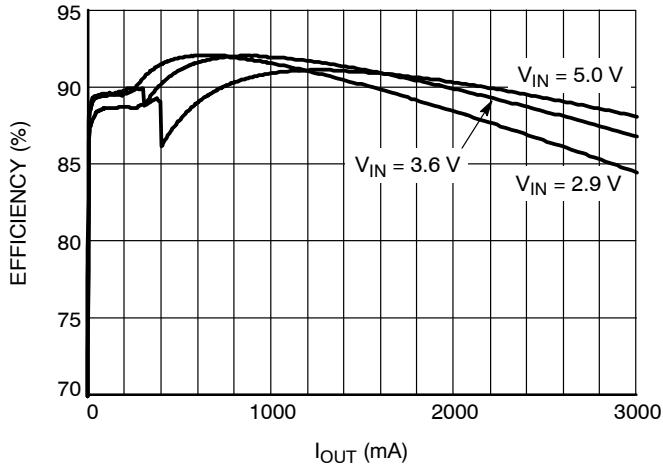

Figure 4. Efficiency vs. I_{LOAD} and V_{IN}
 $V_{\text{OUT}} = 1.39375\text{ V}$, SPM6530 Inductor

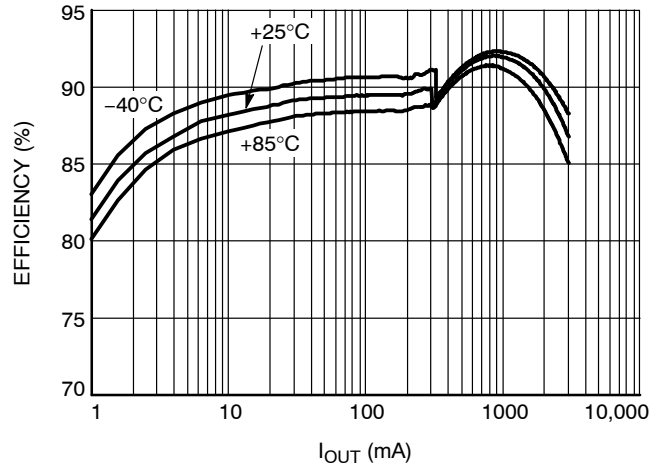

Figure 5. Efficiency vs. I_{LOAD} and Temperature
 $V_{\text{OUT}} = 1.39375\text{ V}$, SPM6530 Inductor

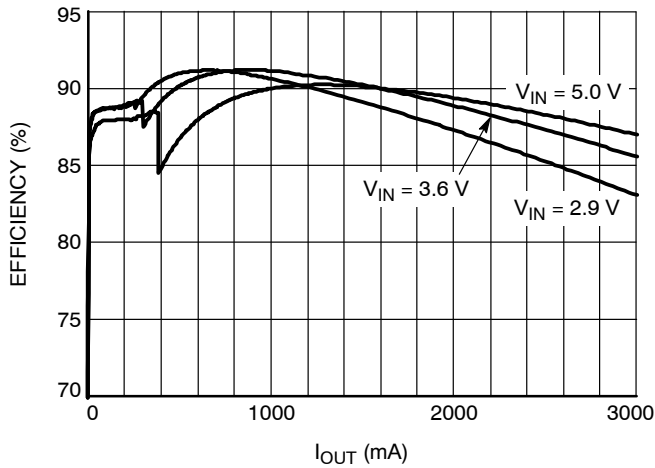

Figure 6. Efficiency vs. I_{LOAD} and V_{IN}
 $V_{\text{OUT}} = 1.225\text{ V}$, SPM6530 Inductor

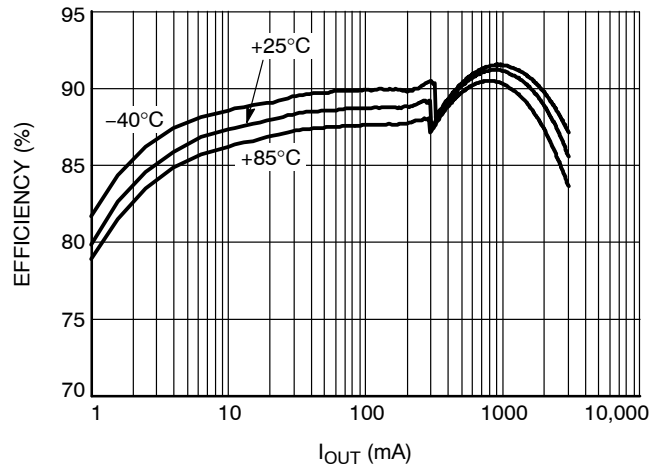

Figure 7. Efficiency vs. I_{LOAD} and Temperature
 $V_{\text{OUT}} = 1.225\text{ V}$, SPM6530 Inductor

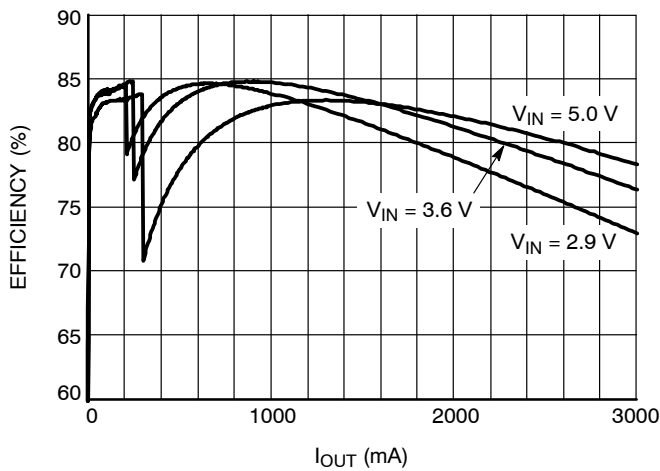

Figure 8. Efficiency vs. I_{LOAD} and V_{IN}
 $V_{\text{OUT}} = 0.60\text{ V}$, SPM6530 Inductor

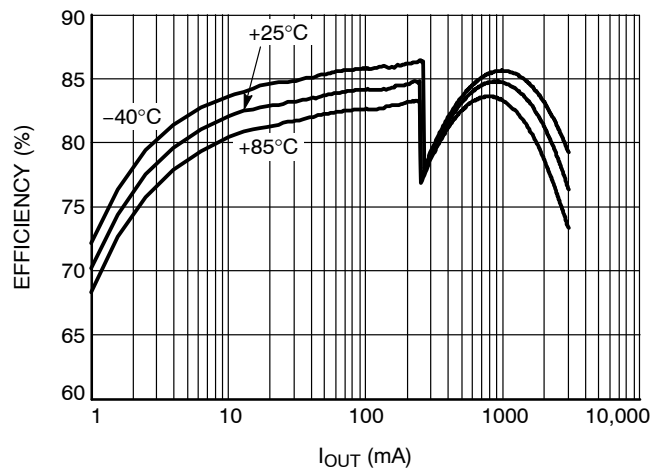

Figure 9. Efficiency vs. I_{LOAD} and Temperature
 $V_{\text{OUT}} = 0.60\text{ V}$, SPM6530 Inductor

TYPICAL OPERATING CHARACTERISTICS $AV_{IN} = PV_{IN} = 3.6\text{ V}$, $T_J = +25^\circ\text{C}$

DCDC = 1.225 V, $I_{\text{peak}} = 3.9\text{ A}$ (Unless otherwise noted). $L = 0.47\ \mu\text{H}$ PIFE20161B – $C_{\text{out}} = 2 \times 22\ \mu\text{F}$ 0603, $C_{\text{in}} = 4.7\ \mu\text{F}$ 0603.

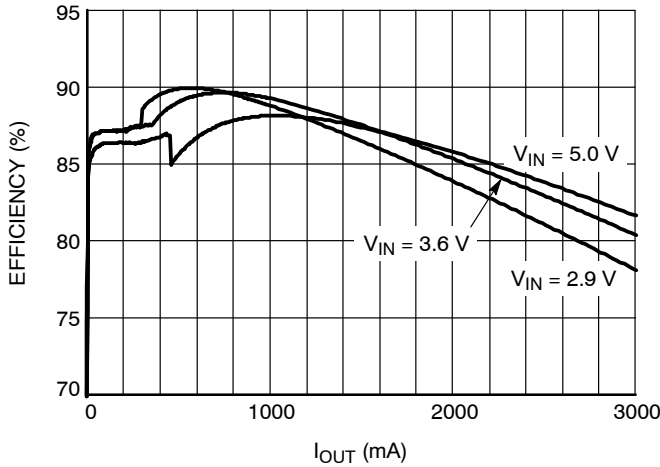

Figure 10. Efficiency vs. I_{LOAD} and V_{IN}
 $V_{\text{OUT}} = 1.225\text{ V}$, PIFE20161B Inductor

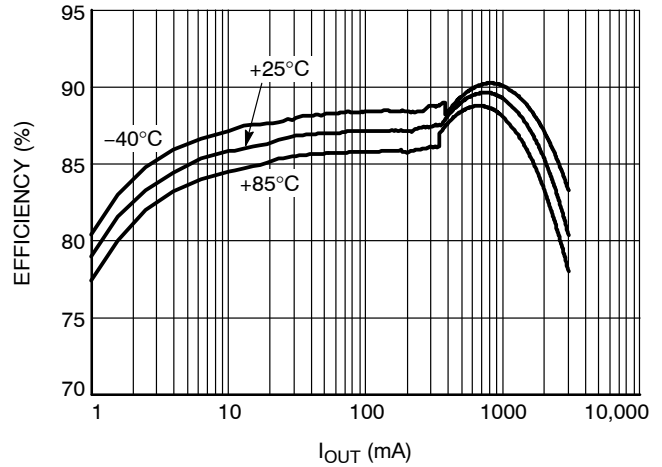

Figure 11. Efficiency vs. I_{LOAD} and Temperature
 $V_{\text{OUT}} = 1.225\text{ V}$, PIFE20161B Inductor

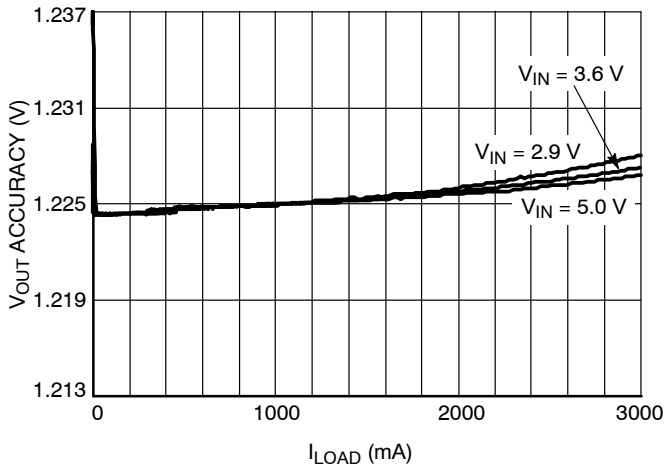

Figure 12. V_{OUT} Accuracy vs. I_{LOAD} and V_{IN}
 $V_{\text{OUT}} = 1.225\text{ V}$

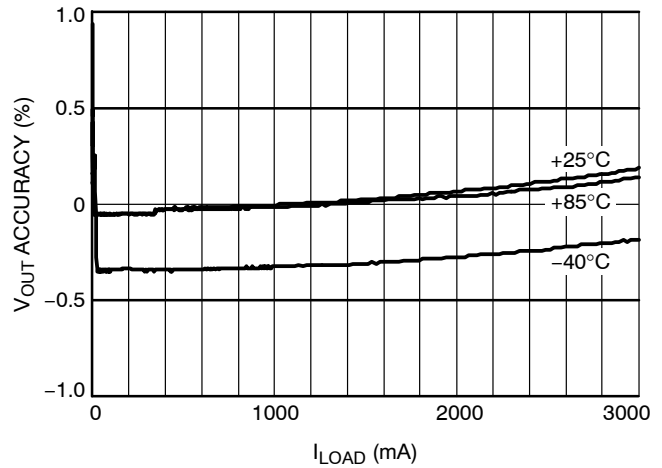

Figure 13. V_{OUT} Accuracy vs. I_{LOAD} and Temperature, $V_{\text{OUT}} = 1.225\text{ V}$, $V_{\text{IN}} = 3.6\text{ V}$

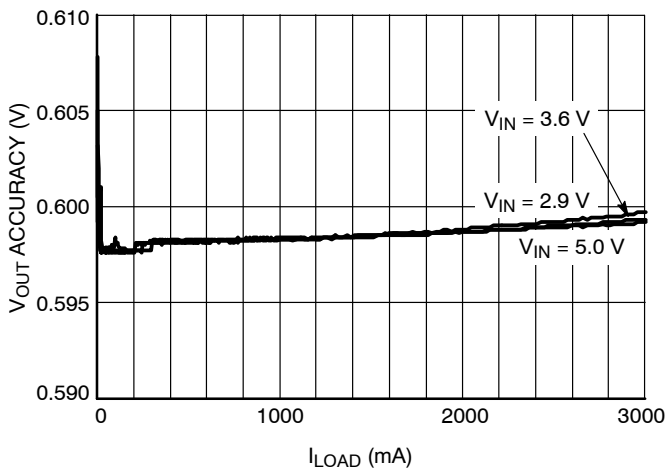

Figure 14. V_{OUT} Accuracy vs. I_{LOAD} and V_{IN}
 $V_{\text{OUT}} = 0.60\text{ V}$

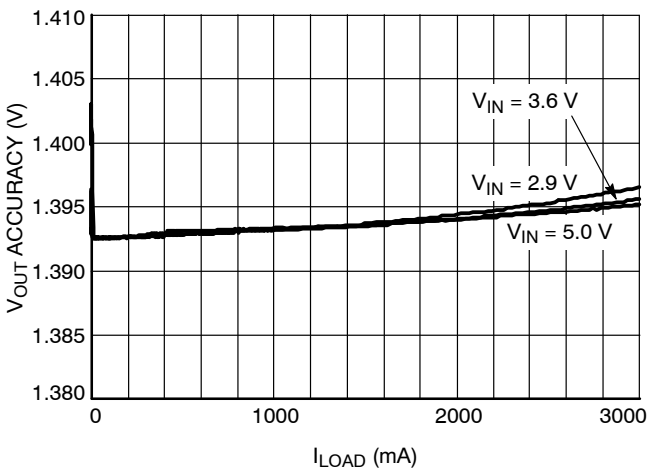

Figure 15. V_{OUT} Accuracy vs. I_{LOAD} and V_{IN}
 $V_{\text{OUT}} = 1.39375\text{ V}$

NCP6343

TYPICAL OPERATING CHARACTERISTICS $AV_{IN} = PV_{IN} = 3.6\text{ V}$, $T_J = +25^\circ\text{C}$

DCDC = 1.225 V, $I_{\text{peak}} = 3.9\text{ A}$ (Unless otherwise noted). $L = 0.47\text{ }\mu\text{H}$ PIFE20161B – $C_{\text{out}} = 2 \times 22\text{ }\mu\text{F}$ 0603, $C_{\text{in}} = 4.7\text{ }\mu\text{F}$ 0603.

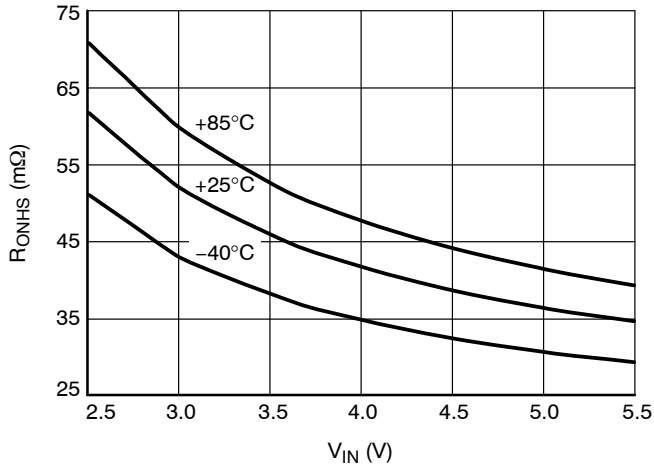

Figure 16. HSS R_{ON} vs. V_{IN} and Temperature

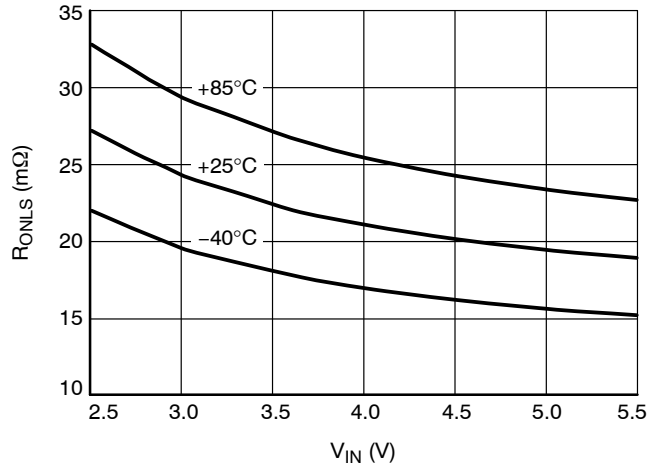

Figure 17. LSS R_{ON} vs. V_{IN} and Temperature

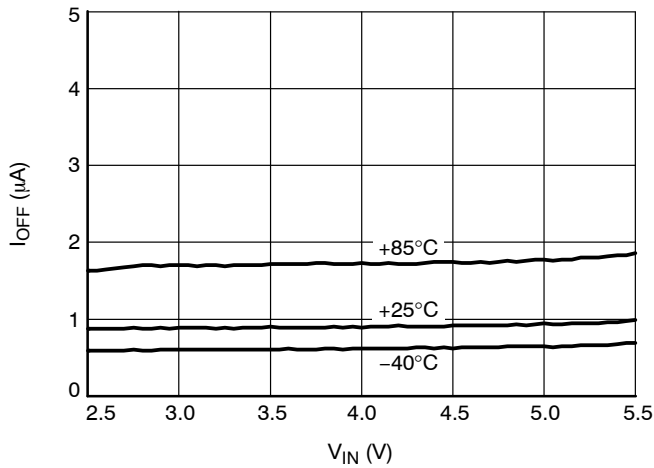

Figure 18. I_{OFF} vs. V_{IN} and Temperature

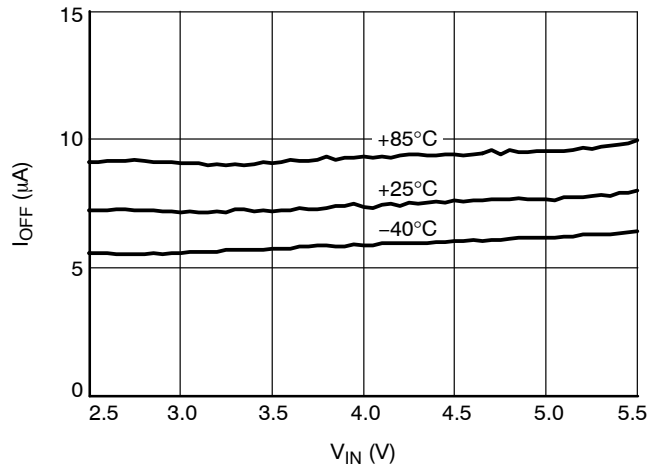

Figure 19. I_{SLEEP} vs. V_{IN} and Temperature

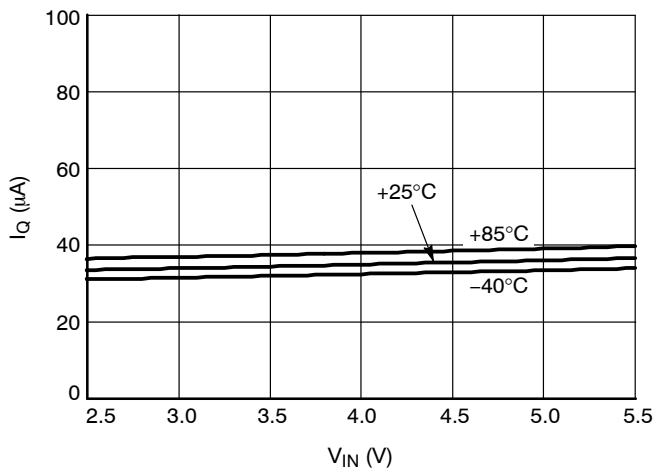

Figure 20. I_Q PFM vs. V_{IN} and Temperature

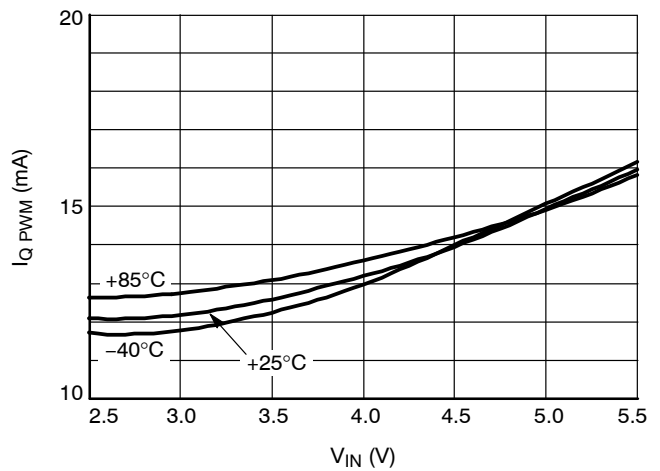

Figure 21. I_Q PWM vs. V_{IN} and Temperature

NCP6343

TYPICAL OPERATING CHARACTERISTICS $V_{IN} = PV_{IN} = 3.6\text{ V}$, $T_J = +25^\circ\text{C}$

DCDC = 1.225 V, $I_{\text{peak}} = 3.9\text{ A}$ (Unless otherwise noted). $L = 0.47\ \mu\text{H}$ PIFE20161B – $C_{\text{out}} = 2 \times 22\ \mu\text{F}$ 0603, $C_{\text{in}} = 4.7\ \mu\text{F}$ 0603.

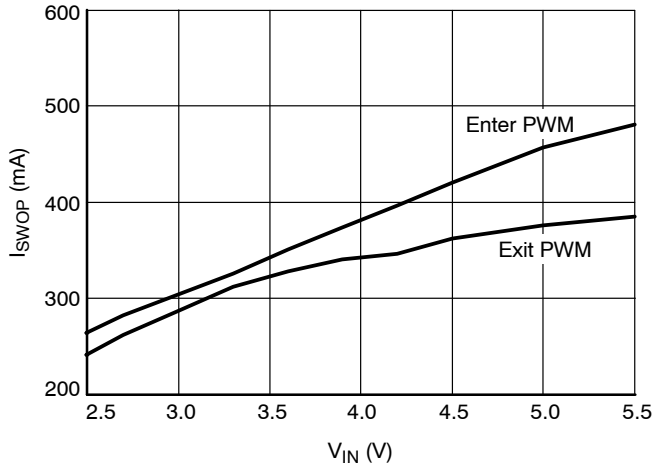

Figure 22. Switchover Point $V_{\text{OUT}} = 1.225\text{ V}$

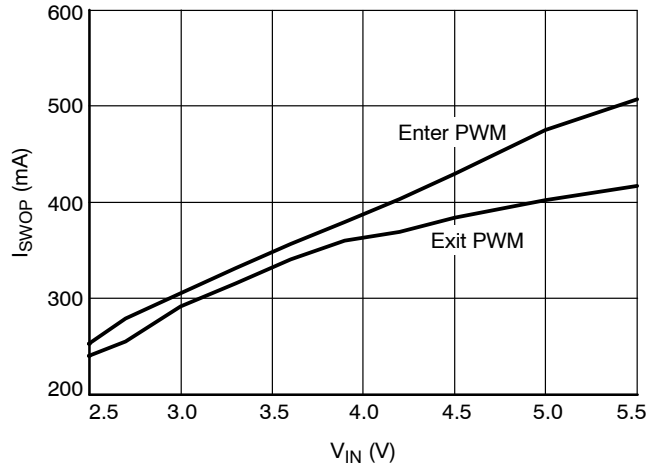

Figure 23. Switchover Point $V_{\text{OUT}} = 1.39375\text{ V}$

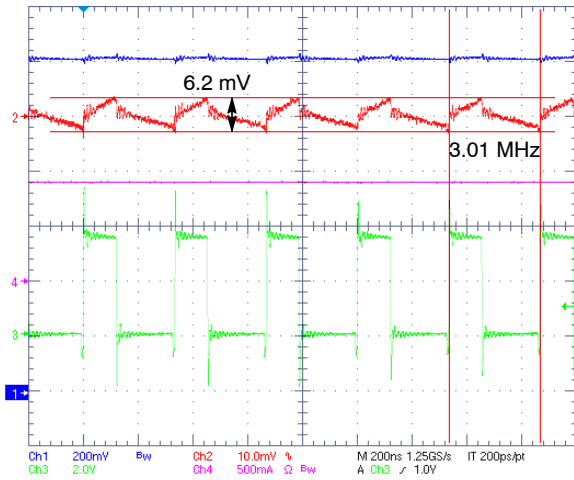

Figure 24. PWM Ripple

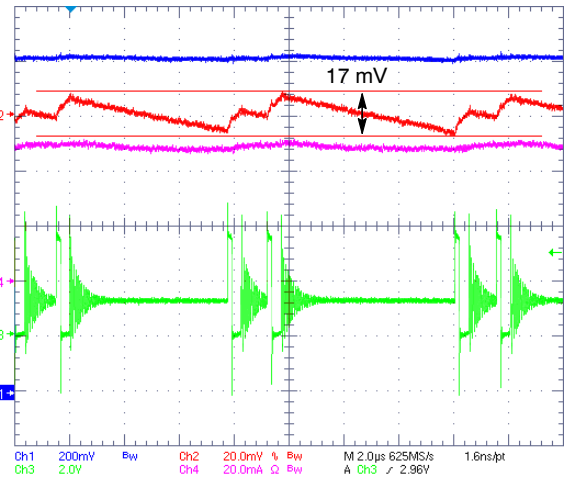

Figure 25. PFM Ripple

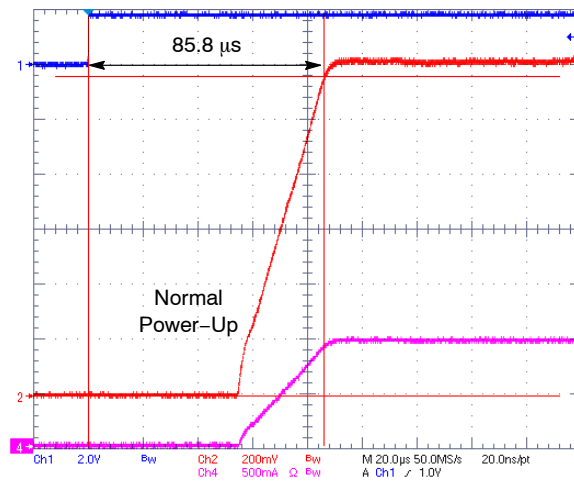
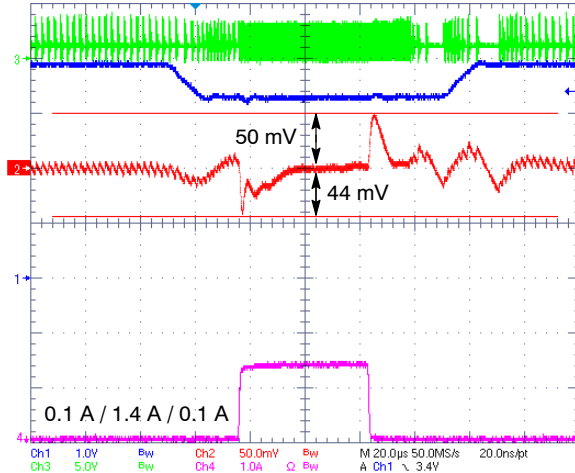

Figure 26. Normal Power Up, $V_{\text{OUT}} = 1.225\text{ V}$

TYPICAL OPERATING CHARACTERISTICS $V_{IN} = PV_{IN} = 3.6\text{ V}$, $T_J = +25^\circ\text{C}$

DCDC = 1.225 V, $I_{peak} = 3.9\text{ A}$ (Unless otherwise noted). $L = 0.47\ \mu\text{H}$ PIFE20161B – $C_{out} = 2 \times 22\ \mu\text{F}$ 0603, $C_{in} = 4.7\ \mu\text{F}$ 0603.



**Figure 27. Transient Load 0.1 – 1.4 A
Transient Line 4.2 – 3.6 V Auto Mode**

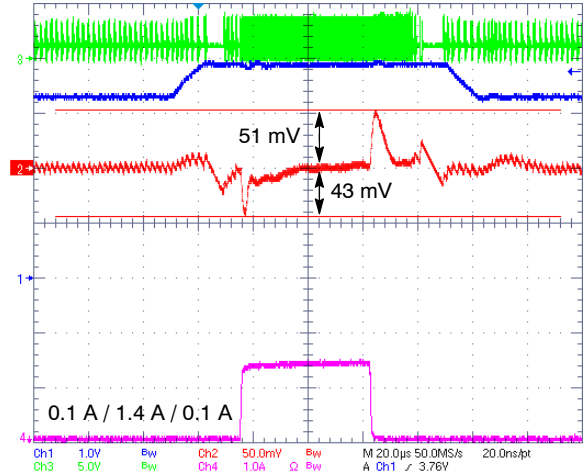

**Figure 28. Transient Load 0.1 – 1.4 A
Transient Line 3.6 – 4.2 V Auto Mode**

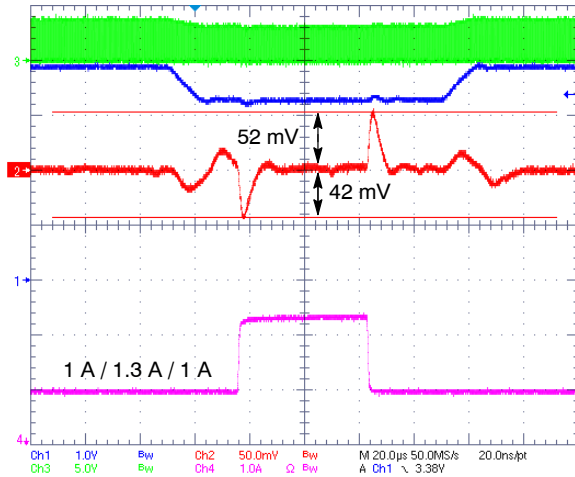

**Figure 29. Transient Load 1.0 – 2.3 A
Transient Line 4.2 – 3.6 V Auto Mode**

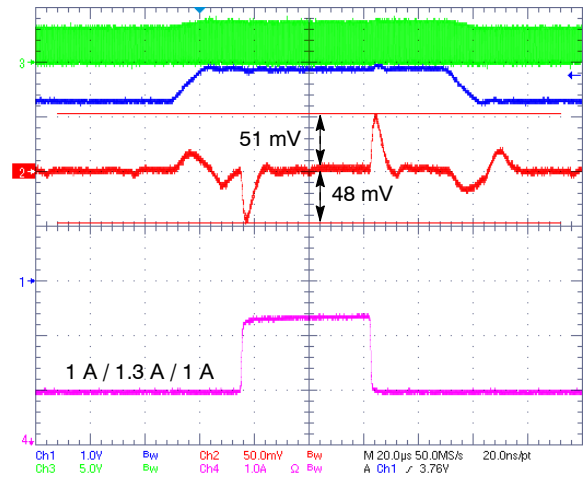

**Figure 30. Transient Load 1.0 – 2.3 A
Transient Line 3.6 – 4.2 V Auto Mode**

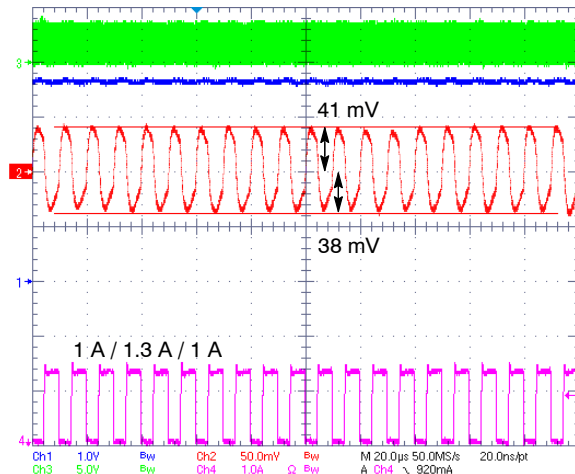

**Figure 31. Fast Transient Load
0.1 – 1.4 A Auto Mode**

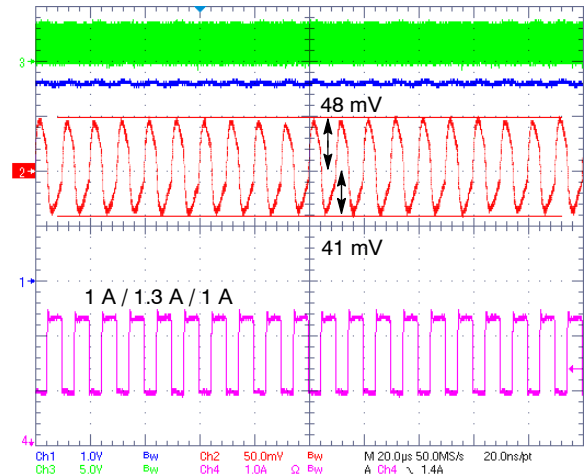

**Figure 32. Fast Transient Load
1.0 – 2.3 A Auto Mode**

DETAILED OPERATING DESCRIPTION

Detailed Descriptions

The NCP6343 is voltage mode stand alone synchronous DC to DC converter optimized to supply different sub systems of portable applications powered by one cell Li-Ion or three cells Alkaline/NiCd/NiMh. The IC can deliver up to 3 A at an I²C selectable voltage ranging from 0.60 V to 1.40 V. It can share the same output rail with another DCDC and works as a transient load helper without sinking current on shared rail. A 3 MHz switching frequency allows the use of smaller output filter components. Synchronous rectification and automatic PWM/PFM transitions improve overall solution efficiency. Forced PWM is also configurable. Operating modes, configuration, and output power can be easily selected either by programming a set of registers using an I²C compatible interface capable of operation up to 3.4 MHz. Default I²C settings are factory programmable.

DC to DC Buck Operation

The converter is a synchronous rectifier type with both high side and low side integrated switches. Neither external transistor nor diodes are required for NCP6343 operation. Feedback and compensation network are also fully integrated. The converter can operate in two different modes: PWM and PFM. The transition between PWM/PFM modes can occur automatically or the switcher can be placed in forced PWM mode by I²C programming (PWM bits of COMMAND register).

PWM (Pulse Width Modulation) Operating Mode

In medium and high load conditions, NCP6343 operates in PWM mode from a fixed clock and adapts its duty cycle to regulate the desired output voltage. In this mode, the inductor current is in CCM (Continuous Current Mode) and the voltage is regulated by PWM. The internal N-MOSFET switch operates as synchronous rectifier and is driven complementary to the P-MOSFET switch. In CCM, the lower switch (N-MOSFET) in a synchronous converter provides a lower voltage drop than the diode in an asynchronous converter, which provides less loss and higher efficiency.

PFM (Pulse Frequency Modulation) Operating Mode

In order to save power and improve efficiency at low loads the NCP6343 operates in PFM mode as the inductor drops into DCM (Discontinuous Current Mode). The upper FET on time is kept constant and the switching frequency is variable. Output voltage is regulated by varying the switching frequency which becomes proportional to loading current. As it does in PWM mode, the internal N-MOSFET operates as synchronous rectifier after each P-MOSFET on-pulse. When load increases and current in inductor becomes continuous again, the controller automatically turns back to PWM mode.

Forced PWM

The NCP6343 can be programmed to only use PWM and disable the transition to PFM if so desired. (PWM bits of COMMAND register).

Output Stage

NCP6343 is a high output current capable integrated DC to DC converter. To supply such a high current, the internal MOSFETs need to be large. The output stage is composed of 8 modules that can be individually Enabled / Disabled by setting the MODULE register.

Inductor Peak Current Limitation

NCP6343 is a 2.0 A to 3.0 A output current capable. During normal operation, peak current limitation will monitor and limit the current through the inductor. This current limitation is particularly useful when size and/or height constrain inductor power. The user can select peak current to keep inductor within its specifications. The peak current can be set by writing IPEAK[1..0] bits in LIMCONF register.

Table 5. Ipeak VALUES

IPEAK[1..0]	Default Inductor Peak Current (A)
00	2.9 A for 2.0 A output current
01	2.9 A for 2.0 A output current
10	3.4 A for 2.5 A output current
11	3.9 A for 3.0 A output current

Output Voltage

Output voltage is set internally by integrated resistor bridge and error amplifier that drives the PWM/PFM controller. No extra component is needed to set output voltage. However, writing in the Vout[6..0] bits of the PROG register will change settings. Output voltage level can be programmed in the 0.6 V to 1.4 V range by 6.25 mV steps.

Under Voltage Lock Out (UVLO)

NCP6343 core does not operate for voltages below the Under Voltage lock Out (UVLO) level. Below UVLO threshold, all internal circuitry (both analog and digital) is held in reset.

NCP6343 operation is guaranteed down to VUVLO when battery voltage is dropping off. To avoid erratic on / off behavior, a maximum 200 mV hysteresis is implemented. Restart is guaranteed at 2.5 V when VBAT voltage is recovering or rising.

Thermal Management

Thermal shutdown (TSD)

The thermal capability of IC can be exceeded due to step down converter output stage power level. A thermal protection circuitry is therefore implemented to prevent the IC from damage. This protection circuitry is only activated

when the core is in active mode (output voltage is turned on). During thermal shut down, output voltage is turned off.

When NCP6343 returns from thermal shutdown, it can re-start in 2 different configurations depending on REARM bit in the LIMCONF register (see register description section):

- If REARM = 0 then NCP6343 does not re-start after TSD. To restart, an EN pin toggle is required.
- If REARM = 1, NCP6343 re-starts with register values set prior to thermal shutdown.

A Thermal shut down interrupt is raised upon this event.

Thermal shut down threshold is set at 150°C (typical) when the die temperature increases and, in order to avoid erratic on / off behavior, a 30°C hysteresis is implemented. After a typical 150°C thermal shut down, NCP6343 will resume to normal operation when the die temperature cools to 120°C.

Thermal Warnings

In addition to the TSD, the die temperature monitoring will flag potential die over temperature. A thermal warning and thermal pre-warning are implemented which can inform the processor through two different interrupts (accessible via I²C) that NCP6343 is close to its thermal shutdown so that preventive measures to cool down die temperature can be taken by software.

The Warning threshold is set by hardware to 135°C typical when the die temperature increases. The Pre-Warning threshold is set by default to 105°C, but can be changed by user by setting the TPWTH[1..0] bits in the LIMCONF register.

Active Output Discharge

To make sure that no residual voltage remains in the power supply rail, an active discharge path can ground the NCP6343 output voltage.

For maximum flexibility, this feature can be easily disabled or enabled with DISCHG bit in PGOOD register

However the discharged path is activated during the first 100 μs after battery insertion.

Enabling

The EN pin controls NCP6343 start up: EN pin Low to High transition starts the power up sequencer. If EN is made low, the DC to DC converter is turned off and device enters:

- In Sleep Mode if Sleep_Mode I²C bit is high,
- In Off Mode if Sleep_Mode I²C bit is low.

When EN pin is set to a high level, the DC to DC converter can be enabled / disabled depending of the state of the EN bit of the PROG register: If EN I²C bit is high, DCDC is activated, If EN I²C is low the DC to DC converter is turned off and device enters:

- In Sleep Mode if Sleep_Mode I²C bit is high,
- In Off Mode if Sleep_Mode I²C bit is low.

The EN pin should not be left floating.

Power Up Sequence (PUS)

In order to power up the circuit, the input voltage AVIN has to rise above the VUVLO threshold. This triggers the internal core circuitry power up which is the “Wake Up Time” (including “Bias Time”).

This delay is internal and cannot be bypassed. EN pin transition within this delay corresponds to the “Initial power up sequence” (IPUS):

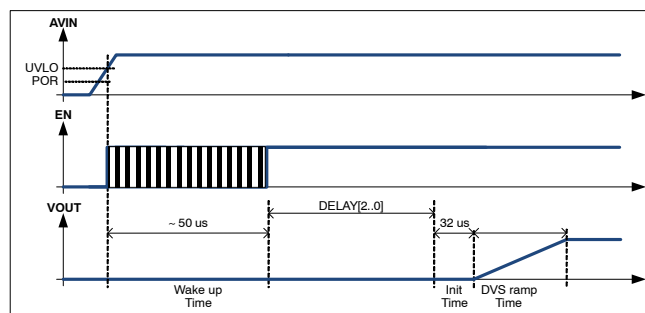

Figure 33. Initial Power Up Sequence

In addition a user programmable delay will also take place between end of Core circuitry turn on (Wake Up Time and Bias Time) and Init time: The DELAY[2..0] bits of TIME register will set this user programmable delay with a 2 ms resolution. With default delay of 0 ms, the NCP6343 IPUS takes roughly 85 μ s, means DCDC output voltage will be ready within 110 μ s.

NOTE: During the Wake Up time, the I²C interface is not active. Any I²C request to the IC during this time period will result in a NACK reply.

Normal, Quick and Fast Power Up Sequence

The previous description applies only when the EN transitions during the internal core circuitry power up (Wake up and calibration time). Otherwise 3 different cases are possible:

Enabling the part by setting EN pin from Off Mode will result in “Normal power up sequence” (NPUS, with DELAY;[2..0]).

Enabling the part by setting EN pin from Sleep Mode will result in “Quick power up sequence” (QPUS, with DELAY;[2..0]).

Enabling the part by setting EN bits of the PROG register (whereas EN is already high results in “Fast power up sequence” (FPUS, without DELAY[2..0]).

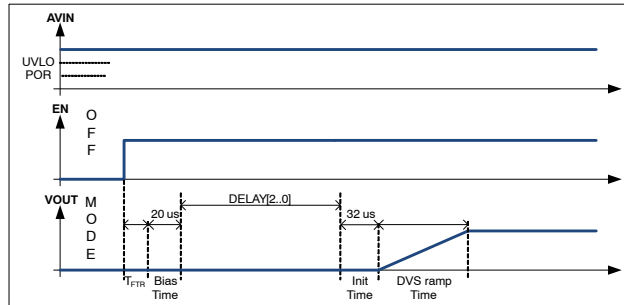

Figure 34. Normal Power Up Sequence (EN pin)

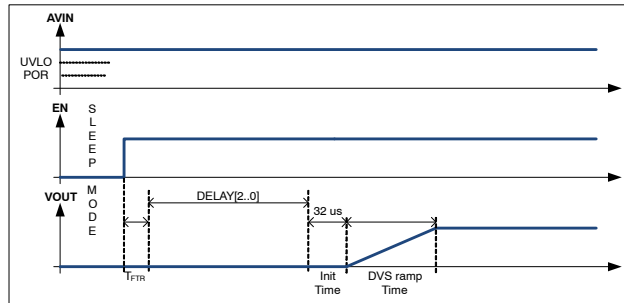

Figure 35. Quick Power Up Sequence (EN pin)

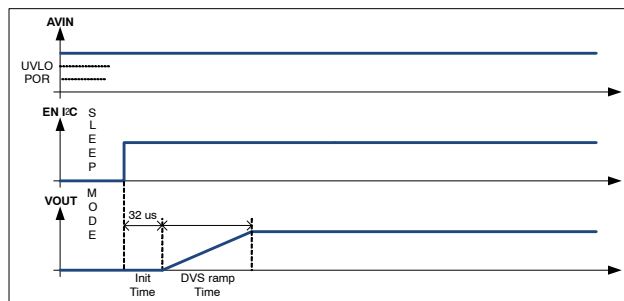

Figure 36. Fast Power Up Sequence (EN bit)

In addition the delay set in DELAY[2..0] bits in TIME register will apply only for the EN pins turn ON sequence (NPUS and QPUS).

Note that the sleep mode needs about 150 μ s to be established.

DC to DC converter Shut Down

When shutting down the device, no shut down sequence is required. Output voltage is disabled and, depending on the DISCHG bit state of PGOOD register, output may be discharged.

Shutdown is initiated by either grounding the EN pin (Hardware Shutdown) or by clearing the EN I²C bit (Software shutdown) in PROG register.

In hardware shutdown (EN = 0), the internal core is still active and I²C accessible.

NCP6343 shuts internal core down when AVIN falls below UVLO.

Dynamic Voltage Scaling (DVS)

This converter supports dynamic voltage scaling (DVS) allowing the output voltage to be reprogrammed via I²C commands and provides the different voltages required by the processor. The change between set points is managed in a smooth fashion without disturbing the operation of the processor.

When programming a higher voltage, output raises with controlled dV/dt defined by DVSup bit in TIME register (default 6.25 mV/0.166 μ s). When programming a lower voltage, output will decrease in equidistant steps defined by DVSDown[1..0] bits in TIME register (default 6.25 mV/2.666 μ s).

DVS sequence is automatically initiated by changing output voltage settings.

The DVS transition mode can be changed with the DVSMODE bit in COMMAND register:

- In forced PWM mode when accurate output voltage control is needed.

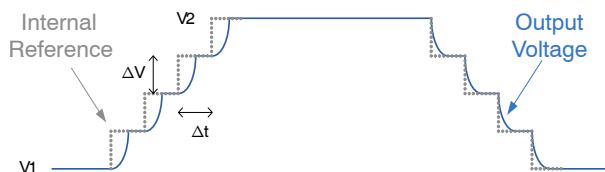

Figure 37. DVS in Forced PWM Mode Diagram

- In Auto mode when output voltage has not to be discharged. Note that approximately 30 μ s is needed to transition from PFM mode to PWM mode.

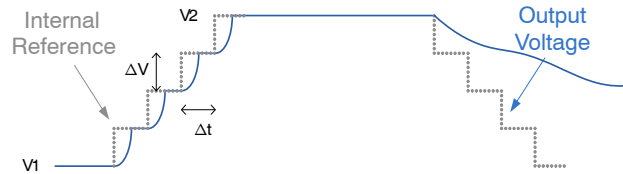

Figure 38. DVS in Auto Mode Diagram

Power Good

To indicate the output voltage level is established, a power good signal is available.

The power good signal is high when the channel is off and goes low when enabling the channel. Once the output voltage reaches 95% of the expected output level, the power good logic signal becomes high (ACK_PG, SEN_PG bits).

During operation when the output drops below 90% of the programmed level the power good logic signal goes low, indicating a power failure. When the voltage rises again to above 95% the power good signal goes high again.

During a positive DVS sequence, when target voltage is higher than initial voltage, the Power Good logic signal will be set low during output voltage ramping and transition to high once the output voltage reaches 95% of the target voltage. When the target voltage is lower than the initial voltage, Power Good logic signals will remain at high level during transition.

Power Good signal during normal operation can be disabled by clearing the PGDCDC bit in PGOOD register.

Power Good operation during DVS can be controlled by setting / clearing the bit PGDVS in PGOOD register

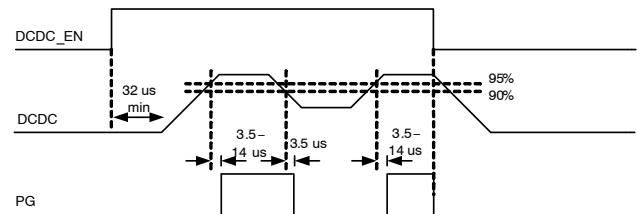

Figure 39. Power Good Signal

NCP6343

Interrupt

The interrupt controller continuously monitors internal interrupt sources, generating an interrupt signal when a system status change is detected (dual edge monitoring).

Table 6. INTERRUPT SOURCES

Interrupt Name	Description
TSD	Thermal Shut Down
TWARN	Thermal Warning
TPREW	Thermal Pre Warning
UVLO	Under Voltage Lock Out
IDCDC	DCDC current Over / below limit
PG	Power Good

Individual bits generating interrupts will be set to 1 in the INT_ACK register (I²C read only registers), indicating the interrupt source. INT_ACK register is automatically reset by an I²C read. The INT_SEN register (read only register) contains real time indicators of interrupt sources.

When the host reads the INT_ACK registers the interrupt register INT_ACK is cleared.

Figure 40 is UVLO event example:

INT_SEN/INT_MSK/INT_ACK and an I²C read access behavior.

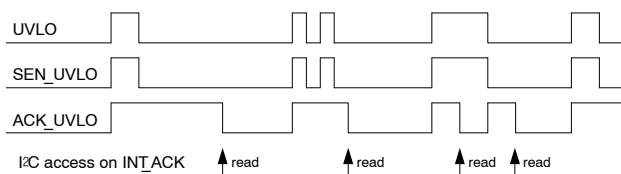

Figure 40. Interrupt Operation Example

Configurations

Default output voltages, enables, DCDC modes, current limit and other parameters can be factory programmed upon request. The default configuration pre-defined is depicted below:

Table 7. DEFAULT CONFIGURATIONS

Configuration	NCP6343	NCP6343A	NCP6343B	NCP6343D
Default I ² C address	0x1C	0x14	0x1C	0x14
PID product id.	12h	12h	12h	12h
RID revision id.	xxh	xxh	xxh	xxh
FID feature id.	00h	02h	01h	03h
VOUT	1.225 V	1.225 V	1.225 V	1.18125 V
MODE	Auto mode	Forced PWM mode	Auto mode	Forced PWM mode
DVS Up Timing	6.25mV/0.166μs	6.25mV/0.166μs	6.25mV/0.166μs	6.25mV/0.166μs
Default IPEAK	2.9 A	3.9 A	3.9 A	3.9 A
Marking	6343	6343A	6343B	6343D
OPN	NCP6343FCT1G	NCP6343AFCCT1G	NCP6343BFCCT1G	NCP6343DFCCT1G

Table 8. DEFAULT CONFIGURATIONS

Configuration	NCP6343AV	NCP6343S	NCP6343M	NCP6343X
Default I ² C address	0x14	0x10	0x18	0x1C
PID product id.	12h	12h	12h	12h
RID revision id.	xxh	xxh	xxh	xxh
FID feature id.	02h	00h	00h	01h
VOUT	1.225 V	1.050 V	0.925 V	1.225 V
MODE	Auto mode	Auto mode	Auto mode	Auto mode
DVS Up Timing	6.25mV/2.666μs	6.25mV/2.666μs	6.25mV/2.666μs	6.25mV/0.166μs
Default IPEAK	3.9 A	3.9 A	3.9 A	3.9 A
Marking	6343V	6343S	6343M	6343X
OPN	NCP6343AVFCCT1G	NCP6343SFCCT1G	NCP6343MFCCT1G	NCP6343XFCCT1G

NCP6343

I²C Compatible Interface

NCP6343 can support a subset of I²C protocol Detailed below.

I²C Communication Description

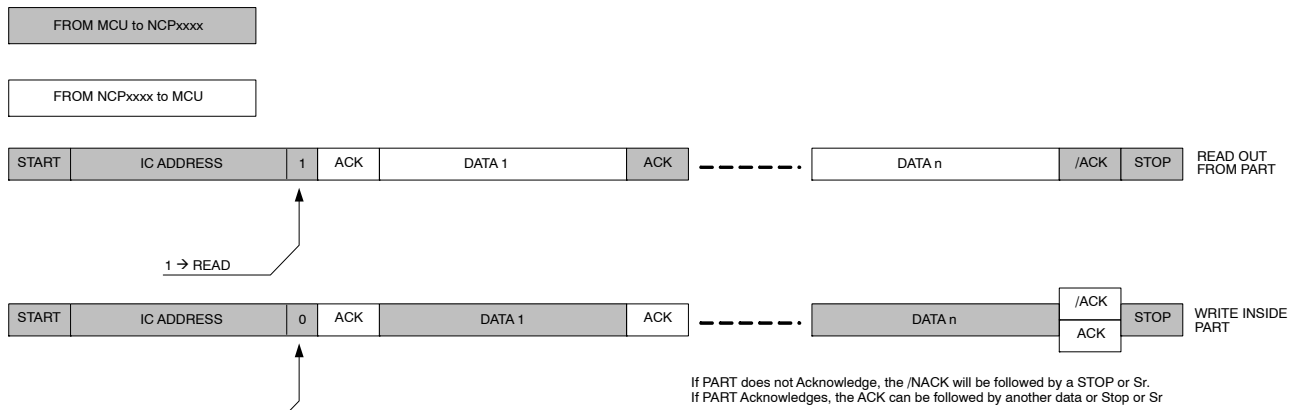

Figure 41. General Protocol Description

The first byte transmitted is the Chip address (with the LSB bit set to 1 for a read operation, or set to 0 for a Write operation). The following data will be:

- In case of a Write operation, the register address (@REG) pointing to the register we want to write in followed by the data we will write in that location. The writing process is auto-incremental, so the first data will be written in @REG, the contents of @REG are incremented and the next data byte is placed in the location pointed to by @REG + 1 ..., etc.

- In case of read operation, the NCP6343 will output the data from the last register that has been accessed by the last write operation. Like the writing process, the reading process is auto-incremental.

Read Out from Part

The Master will first make a “Pseudo Write” transaction with no data to set the internal address register. Then, a stop then start or a Repeated Start will initiate the read transaction from the register address the initial write transaction has pointed to:

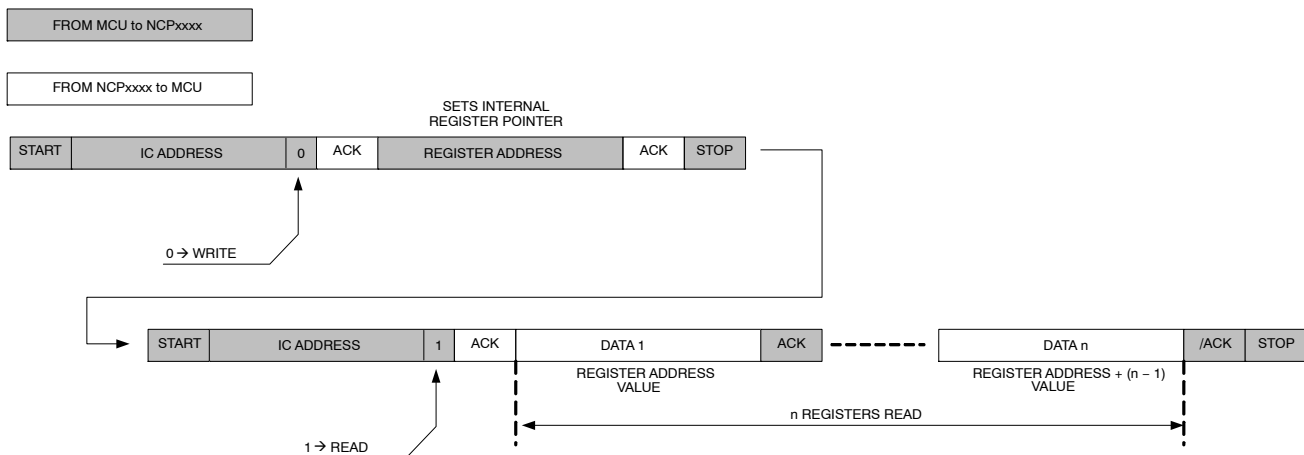

Figure 42. Read Out from Part

The first WRITE sequence will set the internal pointer to the register we want access to. Then the read transaction will start at the address the write transaction has initiated.

Transaction with Real Write then Read

With Stop Then Start

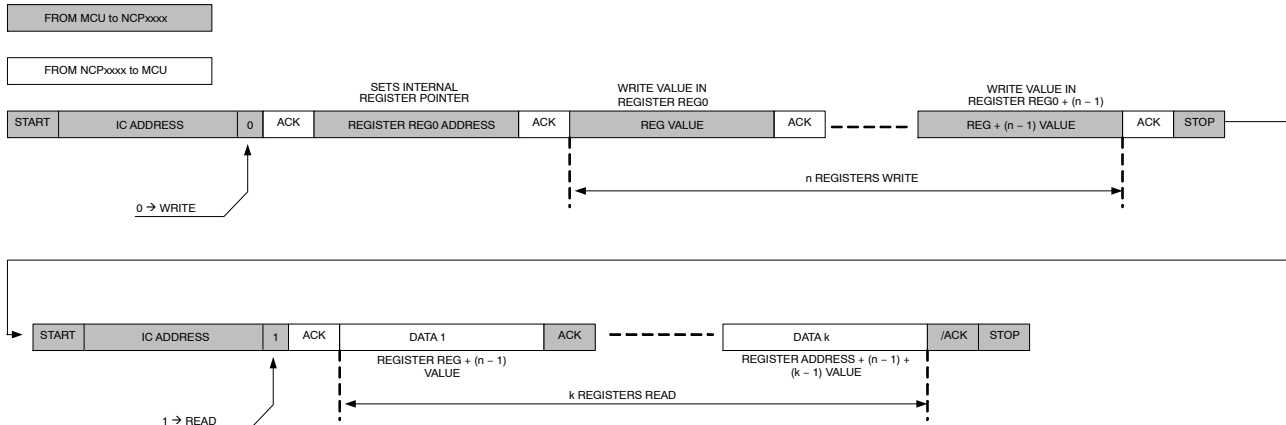

Figure 43. Write Followed by Read Transaction

Write In Part

Write operation will be achieved by only one transaction. After chip address, the MCU first data will be the internal register we want access to, then following data will be the data we want to write in Reg, Reg + 1, Reg + 2, ..., Reg + n.

Write n Registers:

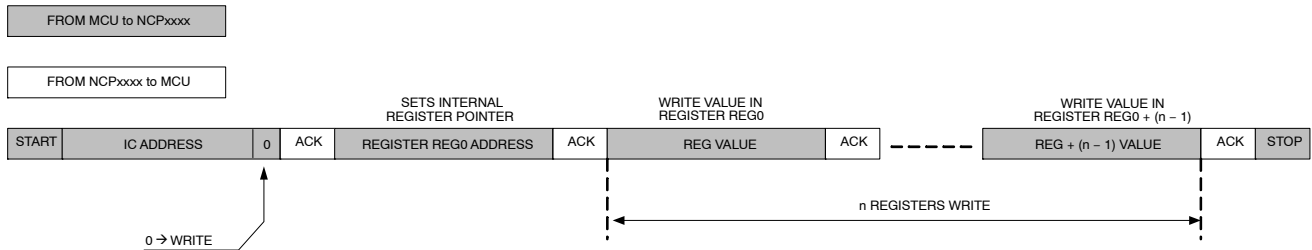

Figure 44. Write In n Registers

I²C Address

NCP6343 has four available I²C address selectable by factory settings (ADD0 to ADD3). Different address settings can be generated upon request to ON Semiconductor. The default address is set to 38h / 39h since the NCP6343 supports 7-bit address only and ignores A0.

Table 9. I²C ADDRESS

I ² C Address	Hex	A7	A6	A5	A4	A3	A2	A1	A0
ADD0 (NCP6343S)	W 0x20 R 0x21	0	0	1	0	0	0	0	R/W
	Add	0x10							-
ADD1 (NCP6343AV, NCP6343D)	W 0x28 R 0x29	0	0	1	0	1	0	0	R/W
	Add	0x14							-
ADD2 (NCP6343M)	W 0x30 R 0x31	0	0	1	1	0	0	0	R/W
	Add	0x18							-
ADD3 (default) (NCP6343, NCP6343B, NCP6343X)	W 0x38 R 0x39	0	0	1	1	1	0	0	R/W
	Add	0x1C							-

NCP6343

Register Map

Table 10 describes I²C registers.

Registers can be:

R	Read only register
RC	Read then Clear
RW	Read and Write register
Reserved	Address is reserved and register is not physically designed
Spare	Address is reserved and register is physically designed

Table 10. I²C REGISTERS MAP DEFAULT CONFIGURATION (NCP6343)

Add.	Register Name	Type	Def.	Function
00h	INT_ACK	RC	00h	Interrupt register
01h	INT_SEN	R	00h	Sense register (real time status)
02h	-	-	-	Reserved for future use
03h	PID	R	12h	Product Identification
04h	RID	R	Metal	Revision Identification
05h	FID	R	00h	Feature Identification (trim)
06h to 10h	-	-	-	Reserved for future use
11h	PROG	RW	E4h	Output voltage settings and (trim)
12h	PGOOD	RW	00h	Power good and active discharge settings (partial trim)
13h	TIME	RW	19h	Enabling and DVS timings (trim)
14h	COMMAND	RW	00h	Enabling and Operating mode Command register (partial trim)
15h	MODULE	RW	80h	Active module count settings
16h	LIMCONF	RW	23h	Reset and limit configuration register (partial trim)
17h to 1Fh	-	-	-	Reserved for future use
20h to FFh	-	-	-	Reserved. Test Registers

Table 11. I²C REGISTERS MAP DEFAULT CONFIGURATION (NCP6343A)

Add.	Register Name	Type	Def.	Function
00h	INT_ACK	RC	00h	Interrupt register
01h	INT_SEN	R	00h	Sense register (real time status)
02h	-	-	-	Reserved for future use
03h	PID	R	12h	Product Identification
04h	RID	R	Metal	Revision Identification
05h	FID	R	02h	Feature Identification (trim)
06h to 10h	-	-	-	Reserved for future use
11h	PROG	RW	E4h	Output voltage settings and (trim)
12h	PGOOD	RW	00h	Power good and active discharge settings (partial trim)
13h	TIME	RW	19h	Enabling and DVS timings (trim)
14h	COMMAND	RW	80h	Enabling and Operating mode Command register (partial trim)
15h	MODULE	RW	80h	Active module count settings
16h	LIMCONF	RW	E3h	Reset and limit configuration register (partial trim)
17h to 1Fh	-	-	-	Reserved for future use
20h to FFh	-	-	-	Reserved. Test Registers

NCP6343

Table 12. I²C REGISTERS MAP DEFAULT CONFIGURATION (NCP6343B)

Addr.	Register Name	Type	Def.	Function
00h	INT_ACK	RC	00h	Interrupt register
01h	INT_SEN	R	00h	Sense register (real time status)
02h	-	-	-	Reserved for future use
03h	PID	R	12h	Product Identification
04h	RID	R	Metal	Revision Identification
05h	FID	R	01h	Feature Identification (trim)
06h to 10h	-	-	-	Reserved for future use
11h	PROG	RW	E4h	Output voltage settings and (trim)
12h	PGOOD	RW	00h	Power good and active discharge settings (partial trim)
13h	TIME	RW	19h	Enabling and DVS timings (trim)
14h	COMMAND	RW	00h	Enabling and Operating mode Command register (partial trim)
15h	MODULE	RW	80h	Active module count settings
16h	LIMCONF	RW	E3h	Reset and limit configuration register (partial trim)
17h to 1Fh	-	-	-	Reserved for future use
20h to FFh	-	-	-	Reserved. Test Registers

Table 13. I²C REGISTERS MAP DEFAULT CONFIGURATION (NCP6343D)

Addr.	Register Name	Type	Def.	Function
00h	INT_ACK	RC	00h	Interrupt register
01h	INT_SEN	R	00h	Sense register (real time status)
02h	-	-	-	Reserved for future use
03h	PID	R	12h	Product Identification
04h	RID	R	Metal	Revision Identification
05h	FID	R	03h	Feature Identification (trim)
06h to 10h	-	-	-	Reserved for future use
11h	PROG	RW	DDh	Output voltage settings and (trim)
12h	PGOOD	RW	00h	Power good and active discharge settings (partial trim)
13h	TIME	RW	19h	Enabling and DVS timings (trim)
14h	COMMAND	RW	80h	Enabling and Operating mode Command register (partial trim)
15h	MODULE	RW	80h	Active module count settings
16h	LIMCONF	RW	E3h	Reset and limit configuration register (partial trim)
17h to 1Fh	-	-	-	Reserved for future use
20h to FFh	-	-	-	Reserved. Test Registers

NCP6343

Table 14. I²C REGISTERS MAP DEFAULT CONFIGURATION (NCP6343AV)

Addr.	Register Name	Type	Def.	Function
00h	INT_ACK	RC	00h	Interrupt register
01h	INT_SEN	R	00h	Sense register (real time status)
02h	-	-	-	Reserved for future use
03h	PID	R	12h	Product Identification
04h	RID	R	Metal	Revision Identification
05h	FID	R	02h	Feature Identification (trim)
06h to 10h	-	-	-	Reserved for future use
11h	PROG	RW	E4h	Output voltage settings and (trim)
12h	PGOOD	RW	00h	Power good and active discharge settings (partial trim)
13h	TIME	RW	1Dh	Enabling and DVS timings (trim)
14h	COMMAND	RW	00h	Enabling and Operating mode Command register (partial trim)
15h	MODULE	RW	80h	Active module count settings
16h	LIMCONF	RW	E3h	Reset and limit configuration register (partial trim)
17h to 1Fh	-	-	-	Reserved for future use
20h to FFh	-	-	-	Reserved. Test Registers

Table 15. I²C REGISTERS MAP DEFAULT CONFIGURATION (NCP6343S)

Addr.	Register Name	Type	Def.	Function
00h	INT_ACK	RC	00h	Interrupt register
01h	INT_SEN	R	00h	Sense register (real time status)
02h	-	-	-	Reserved for future use
03h	PID	R	12h	Product Identification
04h	RID	R	Metal	Revision Identification
05h	FID	R	00h	Feature Identification (trim)
06h to 10h	-	-	-	Reserved for future use
11h	PROG	RW	C8h	Output voltage settings and (trim)
12h	PGOOD	RW	00h	Power good and active discharge settings (partial trim)
13h	TIME	RW	1Dh	Enabling and DVS timings (trim)
14h	COMMAND	RW	00h	Enabling and Operating mode Command register (partial trim)
15h	MODULE	RW	80h	Active module count settings
16h	LIMCONF	RW	E3h	Reset and limit configuration register (partial trim)
17h to 1Fh	-	-	-	Reserved for future use
20h to FFh	-	-	-	Reserved. Test Registers

NCP6343

Table 16. I²C REGISTERS MAP DEFAULT CONFIGURATION (NCP6343M)

Addr.	Register Name	Type	Def.	Function
00h	INT_ACK	RC	00h	Interrupt register
01h	INT_SEN	R	00h	Sense register (real time status)
02h	-	-	-	Reserved for future use
03h	PID	R	12h	Product Identification
04h	RID	R	Metal	Revision Identification
05h	FID	R	00h	Feature Identification (trim)
06h to 10h	-	-	-	Reserved for future use
11h	PROG	RW	B4h	Output voltage settings and (trim)
12h	PGOOD	RW	00h	Power good and active discharge settings (partial trim)
13h	TIME	RW	1Dh	Enabling and DVS timings (trim)
14h	COMMAND	RW	00h	Enabling and Operating mode Command register (partial trim)
15h	MODULE	RW	80h	Active module count settings
16h	LIMCONF	RW	E3h	Reset and limit configuration register (partial trim)
17h to 1Fh	-	-	-	Reserved for future use
20h to FFh	-	-	-	Reserved. Test Registers

Table 17. I²C REGISTERS MAP DEFAULT CONFIGURATION (NCP6343X)

Addr.	Register Name	Type	Def.	Function
00h	INT_ACK	RC	00h	Interrupt register
01h	INT_SEN	R	00h	Sense register (real time status)
02h	-	-	-	Reserved for future use
03h	PID	R	12h	Product Identification
04h	RID	R	Metal	Revision Identification
05h	FID	R	01h	Feature Identification (trim)
06h to 10h	-	-	-	Reserved for future use
11h	PROG	RW	E4h	Output voltage settings and (trim)
12h	PGOOD	RW	00h	Power good and active discharge settings (partial trim)
13h	TIME	RW	19h	Enabling and DVS timings (trim)
14h	COMMAND	RW	00h	Enabling and Operating mode Command register (partial trim)
15h	MODULE	RW	80h	Active module count settings
16h	LIMCONF	RW	E3h	Reset and limit configuration register (partial trim)
17h to 1Fh	-	-	-	Reserved for future use
20h to FFh	-	-	-	Reserved. Test Registers

Registers Description

Table 18. INTERRUPT ACKNOWLEDGE REGISTER

Name: INTACK				Address: 00h			
Type: RC				Default: 0000000b (00h)			
Trigger: Dual Edge [D7..D0]							
D7	D6	D5	D4	D3	D2	D1	D0
ACK_TSD	ACK_TWARN	ACK_TPREW	Spare = 0	Spare= 0	ACK_UVLO	ACK_IDCDC	ACK_PG
Bit		Bit Description					
ACK_PG		Power Good Sense Acknowledgement 0: Cleared 1: DCDC Power Good Event detected					
ACK_IDCDC		DCDC Over Current Sense Acknowledgement 0: Cleared 1: DCDC Over Current Event detected					
ACK_UVLO		Under Voltage Sense Acknowledgement 0: Cleared 1: Under Voltage Event detected					
ACK_TPREW		Thermal Pre Warning Sense Acknowledgement 0: Cleared 1: Thermal Pre Warning Event detected					
ACK_TWARN		Thermal Warning Sense Acknowledgement 0: Cleared 1: Thermal Warning Event detected					
ACK_TSD		Thermal Shutdown Sense Acknowledgement 0: Cleared 1: Thermal Shutdown Event detected					

Table 19. INTERRUPT SENSE REGISTER

Name: INTSEN				Address: 01h			
Type: R				Default: 0000000b (00h)			
Trigger: N/A							
D7	D6	D5	D4	D3	D2	D1	D0
SEN_TSD	SEN_TWARN	SEN_TPREW	Spare = 0	Spare = 0	SEN_UVLO	SEN_IDCDC	SEN_PG
Bit		Bit Description					
SEN_PG		Power Good Sense 0: DCDC Output Voltage below target 1: DCDC Output Voltage within nominal range					
SEN_IDCDC		DCDC over current sense 0: DCDC output current is below limit 1: DCDC output current is over limit					
SEN_UVLO		Under Voltage Sense 0: Input Voltage higher than UVLO threshold 1: Input Voltage lower than UVLO threshold					
SEN_TPREW		Thermal Pre Warning Sense 0: Junction temperature below thermal pre-warning limit 1: Junction temperature over thermal pre-warning limit					
SEN_TWARN		Thermal Warning Sense 0: Junction temperature below thermal warning limit 1: Junction temperature over thermal warning limit					
SEN_TSD		Thermal Shutdown Sense 0: Junction temperature below thermal shutdown limit 1: Junction temperature over thermal shutdown limit					

NCP6343

Table 20. PRODUCT ID REGISTER

Name: PID				Address: 03h			
Type: R				Default: 00010010b (12h)			
Trigger: N/A				Reset on N/A			
D7	D6	D5	D4	D3	D2	D1	D0
PID_7	PID_6	PID_5	PID_4	PID_3	PID_2	PID_1	PID_0

Table 21. REVISION ID REGISTER

Name: RID				Address: 04h			
Type: R				Default: Metal			
Trigger: N/A							
D7	D6	D5	D4	D3	D2	D1	D0
Spare = 0	Spare = 0	Spare = 0	Spare = 0	RID_3	RID_2	RID_1	RID_0
Bit		Bit Description					
RID[3..0]		Revision Identification 0000: First silicon 0100: Optimized silicon 1000: Production					

Table 22. FEATURE ID REGISTER

Name: FID				Address: 05h			
Type: R				Default: Metal			
Trigger: N/A							
D7	D6	D5	D4	D3	D2	D1	D0
Spare = 0	Spare = 0	Spare = 0	Spare = 0	FID_3	FID_2	FID_1	FID_0
Bit		Bit Description					
FID[3..0]		Feature Identification 0000: Default Configuration					

Table 23. DC to DC VOLTAGE PROG REGISTER

Name: PROG				Address: 11h			
Type: RW				Default: See Register map			
Trigger: N/A							
D7	D6	D5	D4	D3	D2	D1	D0
EN		Vout[6..0]					
Bit		Bit Description					
Vout[6..0]		Sets the DC to DC converter output 0000000b = 600 mV – 1111111b = 1393.75 mV (steps of 6.25 mV)					
EN		EN Pin Gating 0: Disabled 1: Enabled					

NCP6343

Table 24. POWER GOOD REGISTER

Name: PGOOD				Address: 12h			
Type: RW				Default: See Register map			
Trigger: N/A							
D7	D6	D5	D4	D3	D2	D1	D0
Spare = 0	Spare = 0	Spare = 0	DISCHG	Spare = 0	Spare = 0	PGDVS	PGDCDC
Bit		Bit Description					
PGDCDC		Power Good Enabling 0 = Disabled 1 = Enabled					
PGDVS		Power Good Active On DVS 0 = Disabled 1 = Enabled					
DISCHG		Active discharge bit Enabling 0 = Discharge path disabled 1 = Discharge path enabled					

Table 25. TIMING REGISTER

Name: TIME				Address: 13h			
Type: RW				Default: See Register map			
Trigger: N/A							
D7	D6	D5	D4	D3	D2	D1	D0
DELAY[2..0]			DVSdown[1..0]		DVSUp	DBN_Time[1..0]	
Bit		Bit Description					
DBN_Time[1..0]		EN debounce time 00 = No debounce 01 = 1–2 μ s 10 = 2–3 μ s 11 = 3–4 μ s					
DVSUp		DVS Speed for up DVS 0 = 6.25 mV step / 0.166 μ s 1 = 6.25 mV step / 2.666 μ s					
DVSdown[1..0]		DVS Speed for down DVS 00 = 6.25 mV step / 0.333 μ s 01 = 6.25 mV step / 0.666 μ s 10 = 6.25 mV step / 1.333 μ s 11 = 6.25 mV step / 2.666 μ s					
DELAY[2..0]		Delay applied upon enabling (ms) 000b = 0 ms – 111b = 14 ms (Steps of 2 ms)					

NCP6343

Table 26. COMMAND REGISTER

Name: COMMAND				Address: 14h			
Type: RW				Default: See Register map			
Trigger: N/A							
D7	D6	D5	D4	D3	D2	D1	D0
PWM	Spare = 0	DVSMODE	Sleep_Mode	Spare = 0	Spare = 0	Spare = 0	Spare = 0
Bit		Bit Description					
Sleep_Mode		Sleep mode 0 = Low Iq mode when EN low 1 = Force product in sleep mode					
DVSMODE		DVS transition mode selection 0 = Auto 1 = Forced PWM					
PWM		DCDC Operating mode 0 = Auto 1 = Forced PWM					

Table 27. OUTPUT STAGE MODULE SETTINGS REGISTER

Name: MODULE				Address: 15h			
Type: RW				Default: See Register map			
Trigger: N/A							
D7	D6	D5	D4	D3	D2	D1	D0
MODUL[3..0]				Spare =0	Spare =0	Spare =0	Spare =0
Bit		Bit Description					
MODUL [3..0]		Number of modules 0000 = 1 Module - 0111 ~ 1111 = 8 Modules (Steps of 1)					

Table 28. LIMITS CONFIGURATION REGISTER

Name: LIMCONF				Address: 16h			
Type: RW				Default: See Register map			
Trigger: N/A							
D7	D6	D5	D4	D3	D2	D1	D0
IPEAK[1..0]		TPWTH[1..0]		Spare = 0	FORCERST	RSTSTATUS	REARM
Bit		Bit Description					
REARM		Rearming of device after TSD 0: No re-arming after TSD 1: Re-arming active after TSD with no reset of I ² C registers: new power-up sequence is initiated with previously programmed I ² C registers values					
RSTSTATUS		Reset Indicator Bit 0: Must be written to 0 after register reset 1: Default (loaded after Registers reset)					
FORCERST		Force Reset Bit 0 = Default value, Self cleared to 0 1: Force reset of internal registers to default					
TPWTH[1..0]		Thermal pre-Warning threshold settings 00 = 83°C 01 = 94°C 10 = 105°C 11 = 116°C					
IPEAK		Inductor peak current settings 00 = 2.9 A (Iload 2.0 A) 01 = 2.9 A (Iload 2.0 A) 10 = 3.4 A (Iload 2.5 A) 11 = 3.9 A (Iload 3.0 A)					

APPLICATION INFORMATION

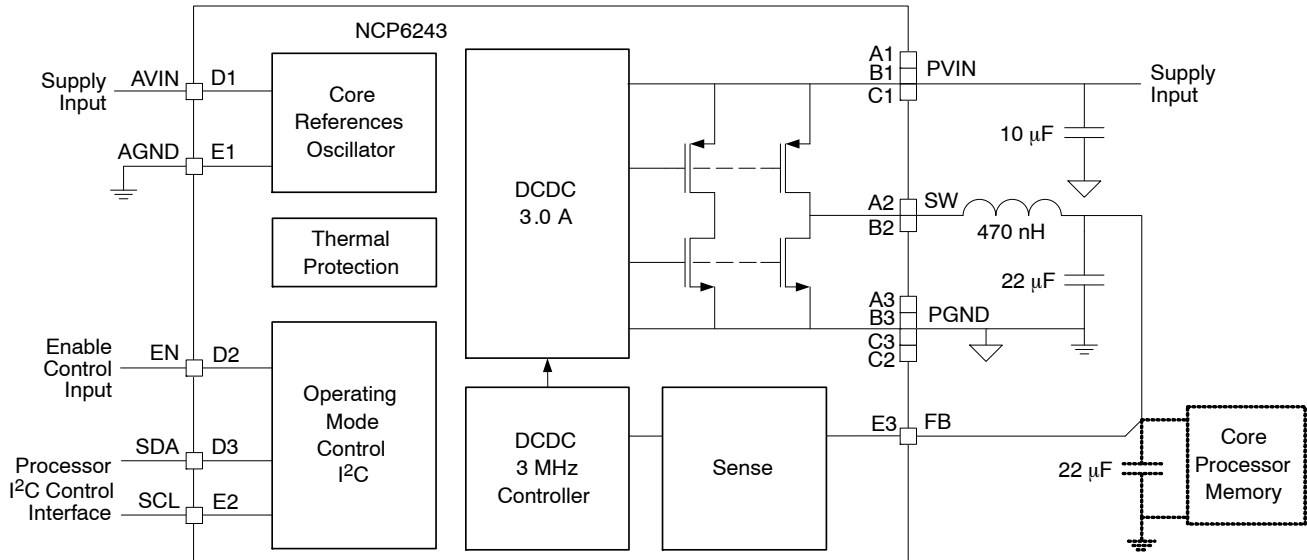

Figure 45. Typical Application Schematic

Output Filter Design Considerations

The output filter introduces a double pole in the system at a frequency of:

$$f_{LC} = \frac{1}{2 \cdot \pi \cdot \sqrt{L \cdot C}}$$

NCP6343 internal compensation network is optimized for a typical output filter comprising a 470 nH inductor and 22 µF capacitor as describes in the basic application schematic is described by Figure 16.

Voltage Sensing Considerations

In order to regulate power supply rail, NCP6343 should sense its output voltage. Thanks to the FB pin, the IC can support two sensing methods:

- Normal case: the voltage sensing is achieved close to the output capacitor. In that case, FB is connected to the output capacitor positive terminal (voltage to regulate).
- Remote sensing: In remote sensing, the power supply rail sense is made close to the system powered by the NCP6343. The voltage to system is more accurate, since PCB line impedance voltage drop is within the regulation loop. In that case, we recommend connecting the FB pin to the system decoupling capacitor positive terminal.

Table 29. INDUCTOR SELECTION

Supplier	Part #	Value (µH)	Size (mm) (L x l x T)	DC Rated Current (A)	DCR Max at 25°C (mΩ)
Cyntec	PIFE20161B-R47-MS-11	0.47	2.0 x 1.6 x 1.2	3.9	36
Cyntec	PIFE25201T-R47-MS-11	0.47	2.5 x 2.0 x 1.0	4.5	41
TOKO	DFE201612P-H-R47M	0.47	2.0 x 1.6 x 1.2	4.3	33
TOKO	DFE201610R-H-R47N	0.47	2.0 x 1.6 x 1.0	3.3	48
TOKO	DFE201612R-H-R47N	0.47	2.0 x 1.6 x 1.2	3.8	40
TDK	TFM252010A-R47M	0.47	2.5 x 2.0 x 1.0	4.5	30
TDK	SPM6530T-R47M170	0.47	7.1 x 6.5 x 3.0	20	4

Components Selection

Inductor Selection

The inductance of the inductor is determined by given peak-to-peak ripple current I_{L_PP} of approximately 20% to 50% of the maximum output current I_{OUT_MAX} for a trade-off between transient response and output ripple. The inductance corresponding to the given current ripple is:

$$L = \frac{(V_{IN} - V_{OUT}) \cdot V_{OUT}}{V_{IN} \cdot f_{SW} \cdot I_{L_PP}}$$

The selected inductor must have high enough saturation current rating to be higher than the maximum peak current that is

$$I_{L_MAX} = I_{OUT_MAX} + \frac{I_{L_PP}}{2}$$

The inductor also needs to have high enough current rating based on temperature rise concern. Low DCR is good for efficiency improvement and temperature rise reduction. Table 29 shows recommended.

Output Capacitor Selection

The output capacitor selection is determined by output voltage ripple and load transient response requirement. For high transient load performance high output capacitor value must be used. For a given peak-to-peak ripple current I_{L_PP} in the inductor of the output filter, the output voltage ripple across the output capacitor is the sum of three components as below.

$$V_{OUT_PP} \approx V_{OUT_PP(C)} + V_{OUT_PP(ESR)} + V_{OUT_PP(ESL)}$$

Where $V_{OUT_PP(C)}$ is a ripple component by an equivalent total capacitance of the output capacitors, $V_{OUT_PP(ESR)}$ is a ripple component by an equivalent ESR of the output capacitors, and $V_{OUT_PP(ESL)}$ is a ripple component by an equivalent ESL of the output capacitors. In PWM operation mode, the three ripple components can be obtained by

$$V_{OUT_PP(C)} = \frac{I_{L_PP}}{8 \cdot C \cdot f_{SW}}, \text{ and } V_{OUT_PP(ESR)} = I_{L_PP} \cdot ESR$$

$$V_{OUT_PP(ESL)} = \frac{ESL}{ESL + L} \cdot V_{IN}$$

and the peak-to-peak ripple current is

$$I_{L_PP} = \frac{(V_{IN} - V_{OUT}) \cdot V_{OUT}}{V_{IN} \cdot f_{SW} \cdot L}$$

In applications with all ceramic output capacitors, the main ripple component of the output ripple is $V_{OUT_PP(C)}$. So that the minimum output capacitance can be calculated regarding to a given output ripple requirement V_{OUT_PP} in PWM operation mode.

$$C_{MIN} = \frac{I_{L_PP}}{8 \cdot V_{OUT_PP} \cdot f_{SW}}$$

Input Capacitor Selection

One of the input capacitor selection guides is the input voltage ripple requirement. To minimize the input voltage ripple and get better decoupling in the input power supply rail, ceramic capacitor is recommended due to low ESR and ESL. The minimum input capacitance regarding to the input ripple voltage V_{IN_PP} is

$$C_{IN_MIN} = \frac{I_{OUT_MAX} \cdot (D - D^2)}{V_{IN_PP} \cdot f_{SW}} \quad \text{where} \quad D = \frac{V_{OUT}}{V_{IN}}$$

In addition, the input capacitor needs to be able to absorb the input current, which has a RMS value of

$$I_{IN_RMS} = I_{OUT_MAX} \cdot \sqrt{D - D^2}$$

The input capacitor also needs to be sufficient to protect the device from over voltage spike, and normally at least 4.7 μ F capacitor is required. The input capacitor should be located as close as possible to the IC. All PGNDs are connected together to the ground terminal of the input cap which then connects to the ground plane. All PVIN are connected together to the Vbat terminal of the input cap which then connects to the Vbat plane.

Electrical Layout Considerations

Good electrical layout is a key to make sure proper operation, high efficiency, and noise reduction. Electrical layout guidelines are:

- Use wide and short traces for power paths (such as PVIN, VOUT, SW, and PGND) to reduce parasitic inductance and high-frequency loop area. It is also good for efficiency improvement.
- The device should be well decoupled by input capacitor and input loop area should be as small as possible to reduce parasitic inductance, input voltage spike, and noise emission.
- SW node should be a large copper, but compact because it is also a noise source.
- It would be good to have separated ground planes for PGND and AGND and connect the two planes at one point. Try best to avoid overlap of input ground loop and output ground loop to prevent noise impact on output regulation.
- Arrange a “quiet” path for output voltage sense, and make it surrounded by a ground plane.

Thermal Layout Considerations

Good PCB layout helps high power dissipation from a small package with reduced temperature rise. Thermal layout guidelines are:

- A four or more layers PCB board with solid ground planes is preferred for better heat dissipation.
- More free vias are welcome to be around IC to connect the inner ground layers to reduce thermal impedance.
- Use large area copper especially in top layer to help thermal conduction and radiation.
- Use two layers for the high current paths (PVIN, PGND, SW) in order to split current in two different paths and limit PCB copper self heating.

NCP6343

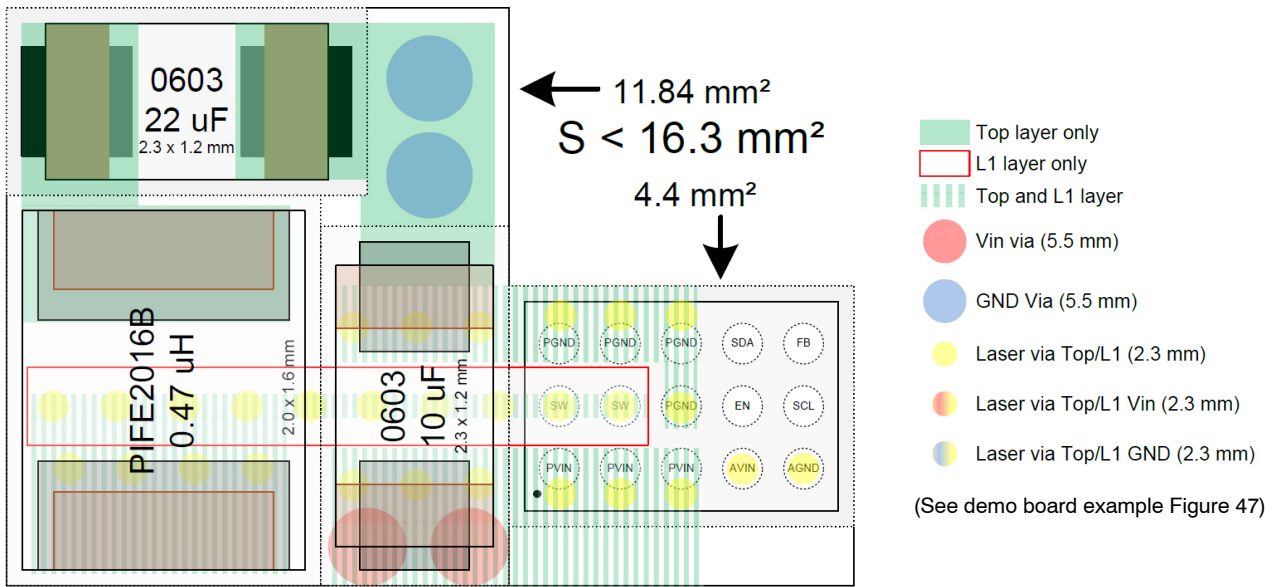

Figure 46. Layout Recommendation

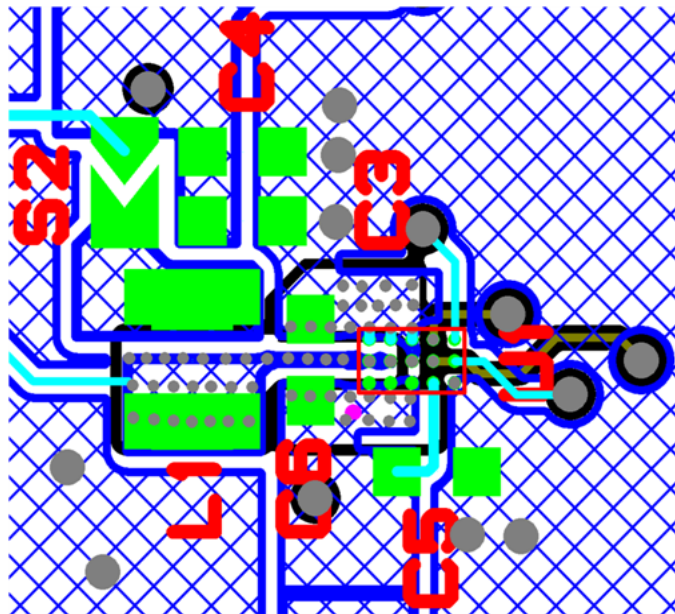

Figure 47. Demo Board Example

Input capacitor placed as close as possible to the IC.

PVIN directly connected to Cin input capacitor, and then connected to the Vin plane. Local mini planes used on the top layer (blue) and layer just below top layer (white) with laser vias.

AVIN connected to the Vin plane just after the capacitor.

AGND directly connected to the GND plane.

PGND directly connected to Cin input capacitor, and then connected to the GND plane: Local mini planes used on the top layer (blue) and layer just below top layer (white) with laser vias.

SW connected to the Lout inductor with trace between input capacitor terminals on top layer (blue) and local mini planes on the layer just below top layer (white) with laser vias.

NCP6343

ORDERING INFORMATION

Device	Marking	Package	Comment	Shipping [†]
NCP6343FCT1G**	6343	WLCSP15 without Back Coating (Pb-Free)	I2C address 0x1C (0011100x b)	3000 / Tape & Reel
NCP6343AFCCT1G**	6343A	WLCSP15 with Back Coating (Pb-Free)	I2C address 0x14 (0010100x b)	3000 / Tape & Reel
NCP6343BFCCT1G**	6343B	WLCSP15 with Back Coating (Pb-Free)	I2C address 0x1C (0011100x b)	3000 / Tape & Reel
NCP6343DFCCT1G**	6343D	WLCSP15 with Back Coating (Pb-Free)	I2C address 0x14 (0010100x b)	3000 / Tape & Reel
NCP6343AVFCCT1G*	6343V	WLCSP15 with Back Coating (Pb-Free)	I2C address 0x14 (0010100x b)	3000 / Tape & Reel
NCP6343SFCCT1G*	6343S	WLCSP15 with Back Coating (Pb-Free)	I2C address 0x10 (0010000x b)	3000 / Tape & Reel
NCP6343MFCCT1G*	6343M	WLCSP15 with Back Coating (Pb-Free)	I2C address 0x18 (0011000x b)	3000 / Tape & Reel
NCP6343XFCCT1G	6343X	WLCSP15 with Back Coating (Pb-Free)	I2C address 0x1C (0011100x b)	3000 / Tape & Reel

[†]For information on tape and reel specifications, including part orientation and tape sizes, please refer to our Tape and Reel Packaging Specifications Brochure, BRD8011/D.

*Not recommended for new designs.

**This device is End of Life. Please contact sales for additional information and assistance with replacement devices.

MECHANICAL CASE OUTLINE

PACKAGE DIMENSIONS

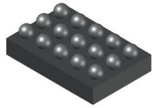

WLCSP15, 1.34x1.99x0.548
CASE 567GB
ISSUE D

DATE 02 JUN 2022

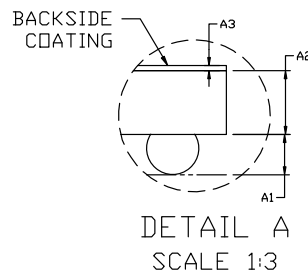
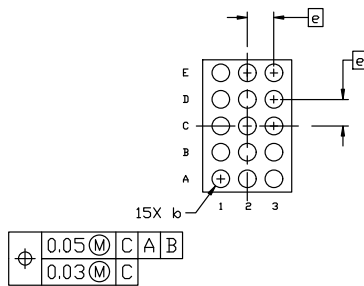
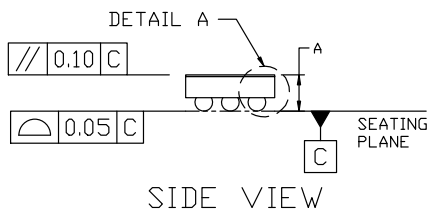
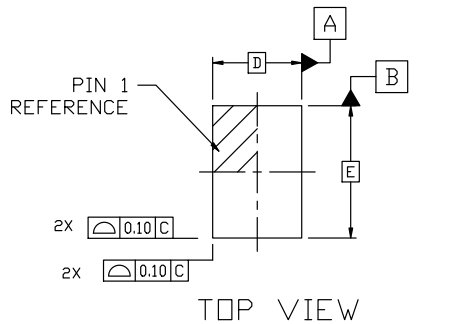

NOTES:

1. DIMENSIONING AND TOLERANCING PER ASME Y14.5M, 2009.
2. CONTROLLING DIMENSION: MILLIMETERS
3. DIMENSION b IS MEASURED AT THE MAXIMUM SOLDER BALL DIAMETER PARALLEL TO DATUM C.
4. COPLANARITY APPLIES TO THE SPHERICAL CROWNS OF THE SOLDER BALLS.
5. DATUM C, THE SEATING PLANE, IS DEFINED BY THE SPHERICAL CROWNS OF THE SOLDER BALLS.

DIM	MILLIMETERS		
	MIN.	NOM.	MAX.
A	0.498	0.548	0.598
A1	0.178	0.203	0.228
A2	0.295	0.320	0.345
A3	0.025 BSC		
b	0.233	0.263	0.293
D	1.34 BSC		
E	1.99 BSC		
e	0.40 BSC		

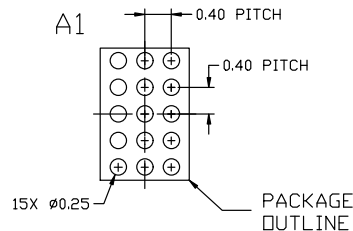

GENERIC MARKING DIAGRAM*

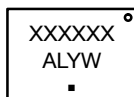

- A = Assembly Location
- L = Wafer Lot
- Y = Year
- W = Work Week
- = Pb-Free Package

*This information is generic. Please refer to device data sheet for actual part marking. Pb-Free indicator, "G" or microdot "▪", may or may not be present. Some products may not follow the Generic Marking.

RECOMMENDED MOUNTING FOOTPRINT*

* For additional information on our Pb-Free strategy and soldering details, please download the ON Semiconductor Soldering and Mounting Techniques Reference Manual, SOLDERRM/D.

DOCUMENT NUMBER:	98AON84651E	Electronic versions are uncontrolled except when accessed directly from the Document Repository. Printed versions are uncontrolled except when stamped "CONTROLLED COPY" in red.
DESCRIPTION:	WLCSP15, 1.34X1.99x0.548	PAGE 1 OF 1

onsemi and ONSEMI are trademarks of Semiconductor Components Industries, LLC dba onsemi or its subsidiaries in the United States and/or other countries. onsemi reserves the right to make changes without further notice to any products herein. onsemi makes no warranty, representation or guarantee regarding the suitability of its products for any particular purpose, nor does onsemi assume any liability arising out of the application or use of any product or circuit, and specifically disclaims any and all liability, including without limitation special, consequential or incidental damages. onsemi does not convey any license under its patent rights nor the rights of others.

onsemi, **Onsemi**, and other names, marks, and brands are registered and/or common law trademarks of Semiconductor Components Industries, LLC dba "**onsemi**" or its affiliates and/or subsidiaries in the United States and/or other countries. **onsemi** owns the rights to a number of patents, trademarks, copyrights, trade secrets, and other intellectual property. A listing of **onsemi**'s product/patent coverage may be accessed at www.onsemi.com/site/pdf/Patent-Marking.pdf. **onsemi** reserves the right to make changes at any time to any products or information herein, without notice. The information herein is provided "as-is" and **onsemi** makes no warranty, representation or guarantee regarding the accuracy of the information, product features, availability, functionality, or suitability of its products for any particular purpose, nor does **onsemi** assume any liability arising out of the application or use of any product or circuit, and specifically disclaims any and all liability, including without limitation special, consequential or incidental damages. Buyer is responsible for its products and applications using **onsemi** products, including compliance with all laws, regulations and safety requirements or standards, regardless of any support or applications information provided by **onsemi**. "Typical" parameters which may be provided in **onsemi** data sheets and/or specifications can and do vary in different applications and actual performance may vary over time. All operating parameters, including "Typicals" must be validated for each customer application by customer's technical experts. **onsemi** does not convey any license under any of its intellectual property rights nor the rights of others. **onsemi** products are not designed, intended, or authorized for use as a critical component in life support systems or any FDA Class 3 medical devices or medical devices with a same or similar classification in a foreign jurisdiction or any devices intended for implantation in the human body. Should Buyer purchase or use **onsemi** products for any such unintended or unauthorized application, Buyer shall indemnify and hold **onsemi** and its officers, employees, subsidiaries, affiliates, and distributors harmless against all claims, costs, damages, and expenses, and reasonable attorney fees arising out of, directly or indirectly, any claim of personal injury or death associated with such unintended or unauthorized use, even if such claim alleges that **onsemi** was negligent regarding the design or manufacture of the part. **onsemi** is an Equal Opportunity/Affirmative Action Employer. This literature is subject to all applicable copyright laws and is not for resale in any manner.

ADDITIONAL INFORMATION

TECHNICAL PUBLICATIONS:

Technical Library: www.onsemi.com/design/resources/technical-documentation
onsemi Website: www.onsemi.com

ONLINE SUPPORT: www.onsemi.com/support

For additional information, please contact your local Sales Representative at www.onsemi.com/support/sales