

NCP629

High Performance CMOS LDO Regulator with Enable and Enhanced ESD Protection in Chip Scale Package (CSP)

The NCP629 provides 150 mA of output current at fixed voltage options. It is designed for portable battery powered applications and offers high performance features such as low power operation, fast enable response time, and low dropout.

The device is designed to be used with low cost ceramic capacitors.

Features

- Output Voltage Options:
1.5 V, 1.8 V, 2.8 V, 3.0 V, 3.3 V, 3.5 V, 5.0 V
- Ultra-Low Dropout Voltage of 150 mV at 150 mA
- Fast Enable Turn-on Time of 15 μ s
- Wide Supply Voltage Operating Range
- Supports sub-1 V Enable Threshold
- Excellent Line and Load Regulation
- High Accuracy up to 2% Output Voltage Tolerance over All Operating Conditions
- Typical Noise Voltage of 50 μ V_{rms} without a Bypass Capacitor
- Ultra Small CSP Footprint and Height: 1.028 x 1.19 mm, Max Height 0.6 mm
- Enhanced ESD Protection (HBM 3.5 kV, MM 400 V)
- These are Pb-Free Devices

Typical Applications

- Personal Electronics (MP3 Players)
- Portable Devices (Cellular Phones)
- Noise Sensitive Circuits – VCO, RF Stages, etc.
- Camcorders and Cameras

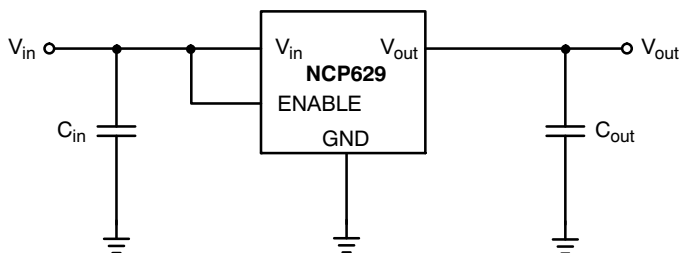

Figure 1. Typical Application Circuit



ON Semiconductor®

<http://onsemi.com>



5 PIN FLIP-CHIP
CASE 499AY

MARKING DIAGRAM

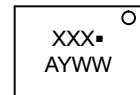

XXX = Specific Device Code
A = Assembly Location
Y = Year
WW = Work Week
▪ = Pb-Free Package

PIN CONNECTIONS

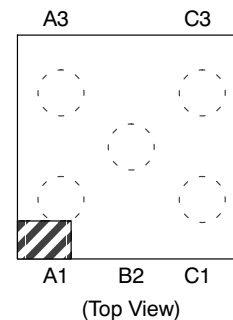

A3 = ENABLE
C3 = V_{in}
C1 = V_{out}
B2 = NC
A1 = GND (substrate)

ORDERING INFORMATION

See detailed ordering and shipping information in the package dimensions section on page 10 of this data sheet.

NCP629

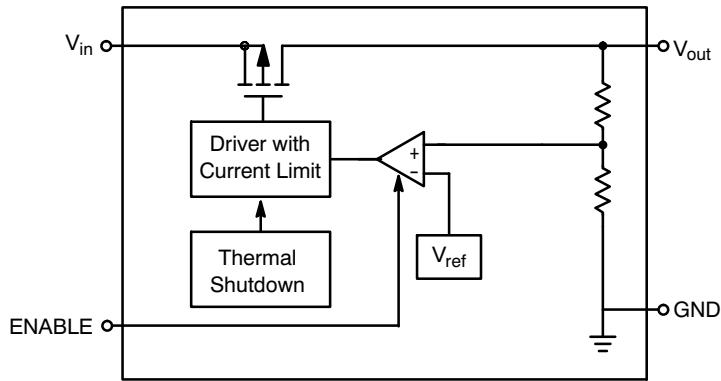

Figure 2. Simplified Block Diagram

PIN FUNCTION DESCRIPTION

Pin No.	Pin Name	Description
C3	V_{in}	Positive Power Supply Input
A1	GND	Power Supply Ground; Device Substrate
A3	ENABLE	The Enable Input places the device into low-power standby when pulled to logic low (< 0.4 V). Connect to V_{in} if the function is not used.
B2	NC	No Connection
C1	V_{out}	Regulated Output Voltage

ABSOLUTE MAXIMUM RATINGS

Rating	Symbol	Value	Unit
Input Voltage Range (Note 1)	V_{in}	-0.3 to 6.5	V
Output Voltage Range	V_{out}	-0.3 to 6.5 (or $V_{in} + 0.3$) Whichever is Lower	V
Enable Input Range	ENABLE	-0.3 to 6.5 (or $V_{in} + 0.3$) Whichever is Lower	V
Maximum Junction Temperature	$T_{J(max)}$	150	°C
Storage Temperature Range	T_{STG}	-65 to 150	°C
ESD Capability, Human Body Model (Note 2)	ESD _{HBM}	3500	V
ESD Capability, Machine Model (Note 2)	ESD _{MM}	400	V
Moisture Sensitivity Level	MSL	MSL1/260	-

Stresses exceeding Maximum Ratings may damage the device. Maximum Ratings are stress ratings only. Functional operation above the Recommended Operating Conditions is not implied. Extended exposure to stresses above the Recommended Operating Conditions may affect device reliability.

1. Refer to ELECTRICAL CHARACTERISTICS and APPLICATION INFORMATION for Safe Operating Area.
2. This device series incorporates ESD protection and is tested by the following methods:
 ESD Human Body Model tested per AEC-Q100-002 (EIA/JESD22-A114)
 ESD Machine Model tested per AEC-Q100-003 (EIA/JESD22-A115)
 Latchup Current Maximum Rating: ≤150 mA per JEDEC standard: JESD78.

THERMAL CHARACTERISTICS

Rating	Symbol	Value	Unit
Thermal Characteristics (Note 3) Thermal Resistance, Junction-to-Air (Note 4)	$R_{\theta JA}$	277	°C/W

3. Refer to ELECTRICAL CHARACTERISTICS and APPLICATION INFORMATION for Safe Operating Area.
4. Values based on copper area of 645 mm², 1 oz copper thickness.

OPERATING RANGES (Note 5)

Rating	Symbol	Min	Max	Unit
Operating Input Voltage (Note 6)	V_{in}	1.5	6	V
Output Current	I_{out}	0	150	mA
Ambient Temperature	T_A	-40	125	°C

5. Refer to ELECTRICAL CHARACTERISTICS and APPLICATION INFORMATION for Safe Operating Area.
6. Minimum $V_{in} = 1.5$ V or ($V_{out} + V_{DO}$), whichever is higher.

NCP629

ELECTRICAL CHARACTERISTICS

($V_{in} = V_{out} + 0.5\text{ V}$, $C_{in} = C_{out} = 1.0\ \mu\text{F}$, for typical values $T_A = 25^\circ\text{C}$, for min/max values $T_A = -40^\circ\text{C}$ to 125°C ; unless otherwise noted.)
(Note 7)

Parameter	Test Conditions	Symbol	Min	Typ	Max	Unit
Regulator Output						
Output Voltage 1.5 V 1.8 V 2.8 V 3.0 V 3.3 V 3.5 V 5.0 V	$I_{out} = 1.0\text{ mA to }150\text{ mA}$ $V_{in} = (V_{out} + 0.5\text{ V})\text{ to }6.0\text{ V}$	V_{out}	1.470 1.764 2.744 2.940 3.234 3.430 4.900 (-2%)		1.530 1.836 2.856 3.060 3.366 3.570 5.100 (+2%)	V
Power Supply Ripple Rejection (Note 8) ($V_{in} = V_{out} + 1.0\text{ V} + 0.5\text{ V}_{p-p}$)	$I_{out} = 1.0\text{ mA to }150\text{ mA}$ $f = 120\text{ Hz}$ $f = 1.0\text{ kHz}$ $f = 10\text{ kHz}$	PSRR	- - -	62 55 38	- - -	dB
Line Regulation	$V_{in} = (V_{out} + 0.5\text{ V})\text{ to }6.0\text{ V}$, $I_{out} = 1.0\text{ mA}$	Reg _{line}	-	1.0	10	mV
Load Regulation 1.5 V 1.8 V 2.8 V to 5.0 V	$I_{out} = 1.0\text{ mA to }150\text{ mA}$	Reg _{load}	- - -	2.0 2.0 2.0	20 25 30	mV
Output Noise Voltage (Note 8)	$V_{out} = 1.5\text{ V}$, $f = 10\text{ Hz to }100\text{ kHz}$	V_n	-	50	-	μV_{rms}
Output Short Circuit Current	$V_{out} = 0\text{ V}$	I_{sc}	300	550	800	mA
Dropout Voltage 1.5 V 1.8 V 2.8 V to 5.0 V	Measured at: $V_{out} - 2.0\%$ $I_{out} = 150\text{ mA}$	V_{DO}	- - -	150 125 75	225 175 125	mV

General

Disable Current	ENABLE = 0 V, $V_{in} = 6\text{ V}$ $-40^\circ\text{C} \leq T_A \leq 85^\circ\text{C}$	I_{DIS}	-	0.01	1.0	μA
Ground Current 1.5 V 1.8 V to 3.0 V 3.3 V to 5.0 V	ENABLE = 0.9 V, $I_{out} = 1.0\text{ mA to }150\text{ mA}$	I_{GND}	- - -	135 140 145	170 175 180	μA
Thermal Shutdown Temperature (Note 8)		T_{SD}	-	175	-	$^\circ\text{C}$
Thermal Shutdown Hysteresis (Note 8)		T_{SH}	-	10	-	$^\circ\text{C}$

Chip Enable

ENABLE Input Threshold Voltage Voltage Increasing, Logic High Voltage Decreasing, Logic Low		$V_{th(EN)}$	0.9 -	- -	- 0.4	V
Enable Input Bias Current (Note 8)		I_{EN}	-	3.0	100	nA

Timing

Output Turn On Time 1.5 V to 3.5 V 5.0 V	ENABLE = 0 V to V_{in}	t_{on}	- -	15 30	25 50	μs
--	--------------------------	----------	--------	----------	----------	---------------

7. Performance guaranteed over the indicated operating temperature range by design and/or characterization, production tested at $T_J = T_A = 25^\circ\text{C}$. Low duty cycle pulse techniques are used during testing to maintain the junction temperature as close to ambient as possible.
8. Values based on design and/or characterization.

NCP629

TYPICAL CHARACTERISTICS

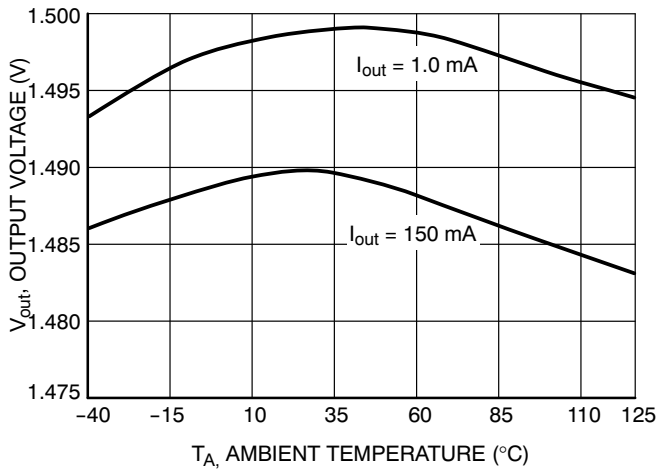

Figure 3. Output Voltage vs. Temperature
(1.5 V Fixed Output, V_{in} = 2 V)

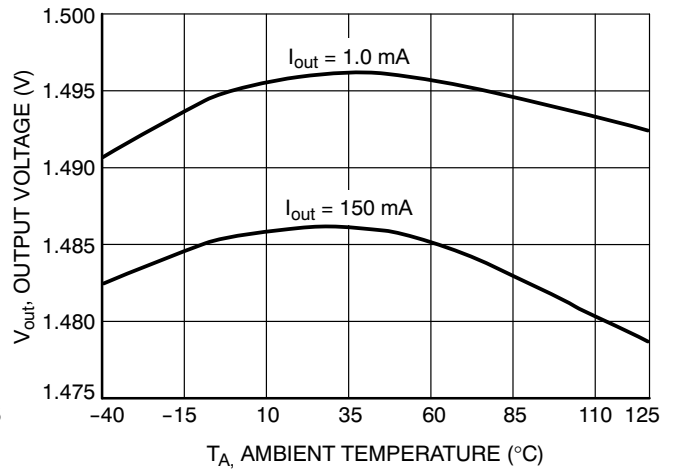

Figure 4. Output Voltage vs. Temperature
(1.5 V Fixed Output, V_{in} = 6 V)

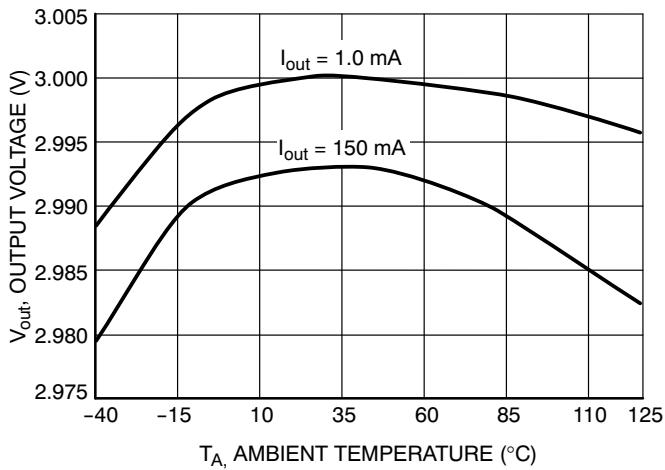

Figure 5. Output Voltage vs. Temperature
(3.0 V Fixed Output, V_{in} = 3.5 V)

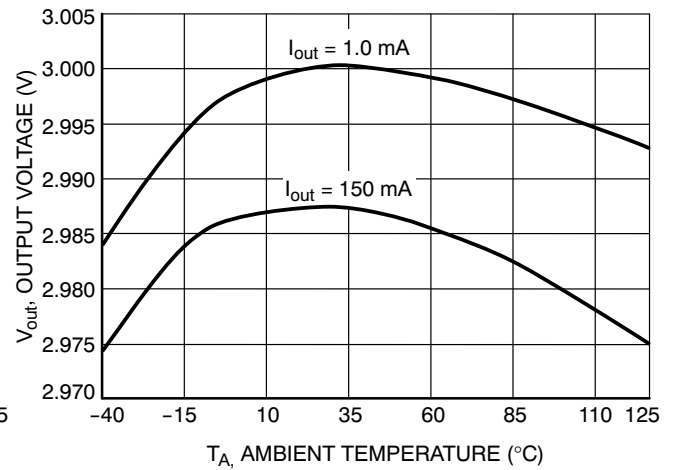

Figure 6. Output Voltage vs. Temperature
(3.0 V Fixed Output, V_{in} = 6 V)

TYPICAL CHARACTERISTICS

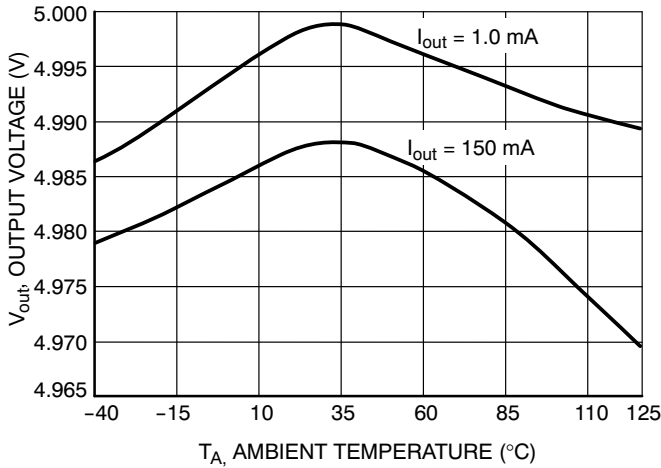

Figure 7. Output Voltage vs. Temperature
(5.0 V Fixed Output, $V_{in} = 5.5$ V)

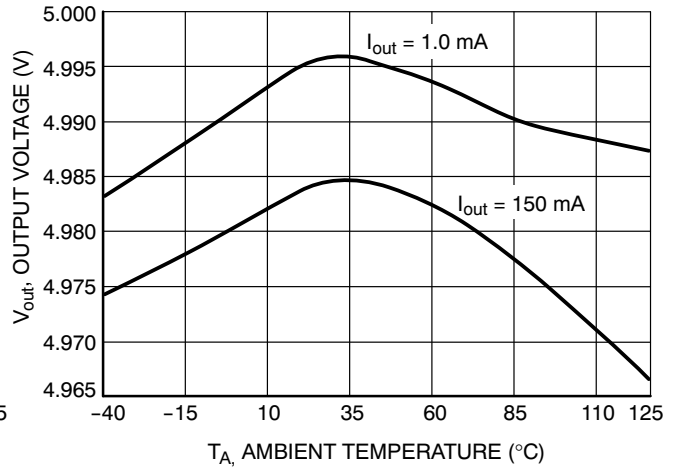

Figure 8. Output Voltage vs. Temperature
(5.0 V Fixed Output, $V_{in} = 6$ V)

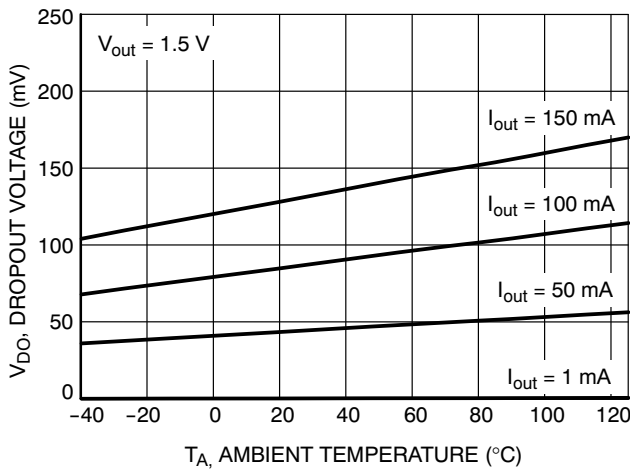

Figure 9. Dropout Voltage vs. Temperature
(Over Current Range)

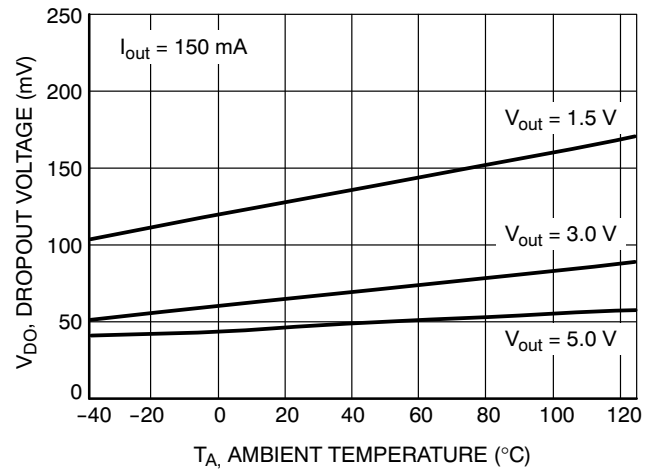

Figure 10. Dropout Voltage vs. Temperature
(Over Output Voltage)

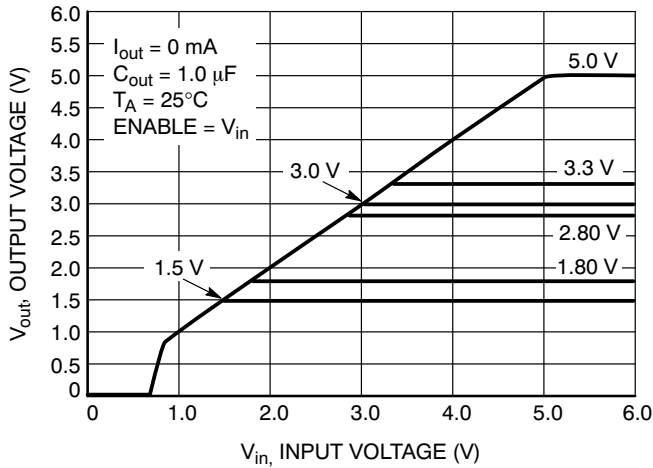

Figure 11. Output Voltage vs. Input Voltage

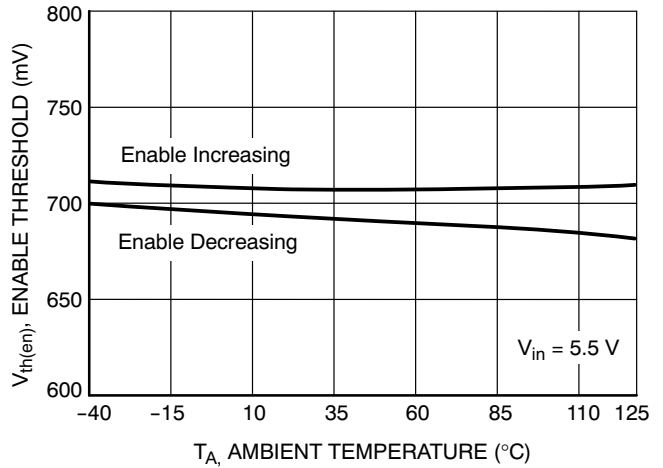

Figure 12. Enable Threshold vs. Temperature

TYPICAL CHARACTERISTICS

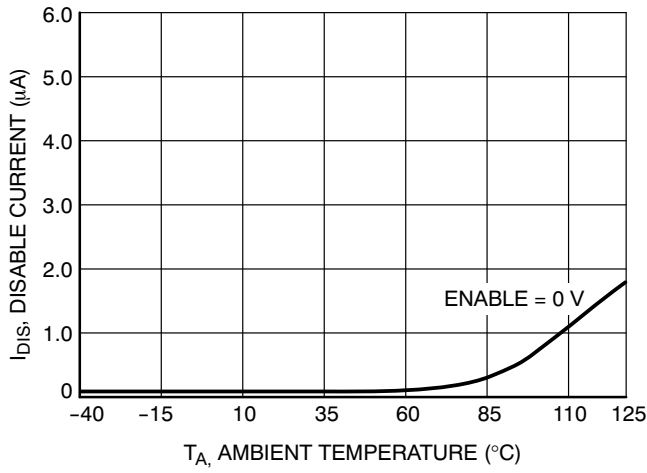

Figure 13. Ground Current (Sleep Mode) vs. Temperature

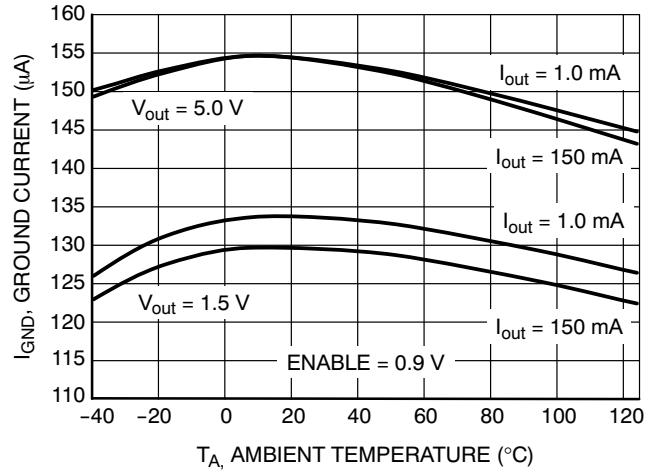

Figure 14. Ground Current (Run Mode) vs. Temperature

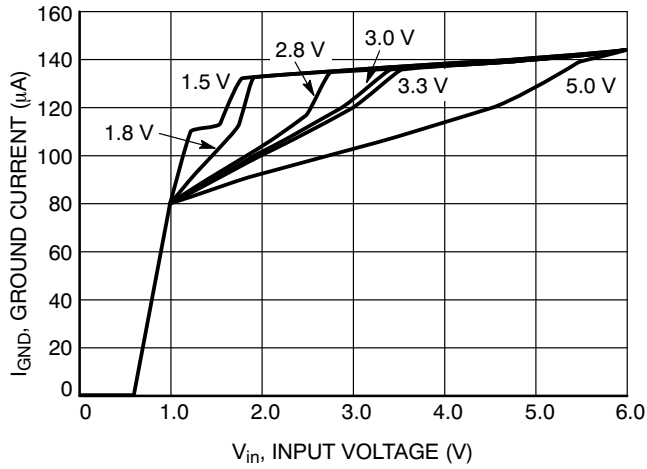

Figure 15. Ground Current vs. Input Voltage

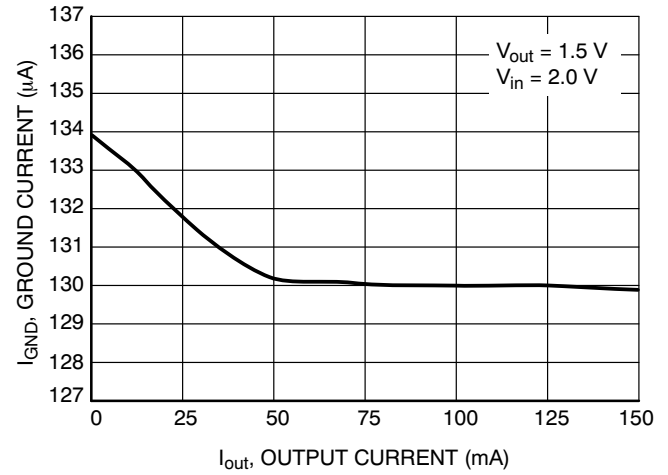

Figure 16. Ground Current vs. Output Current

NCP629

TYPICAL CHARACTERISTICS

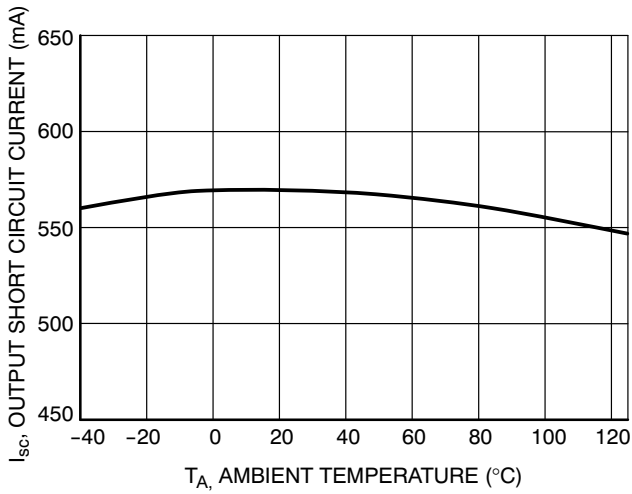

Figure 17. Output Short Circuit Current vs. Temperature

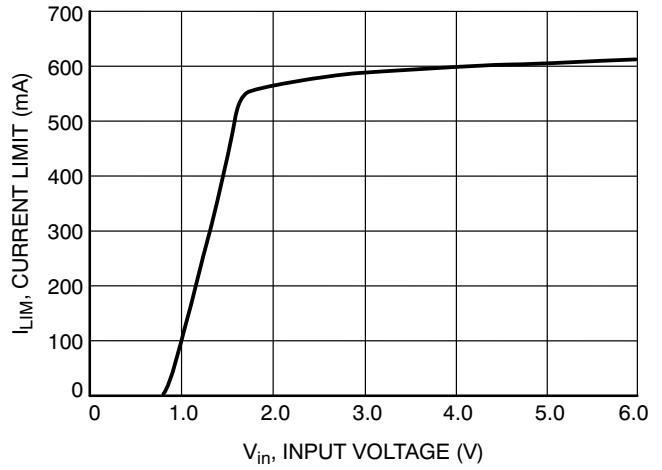

Figure 18. Current Limit vs. Input Voltage

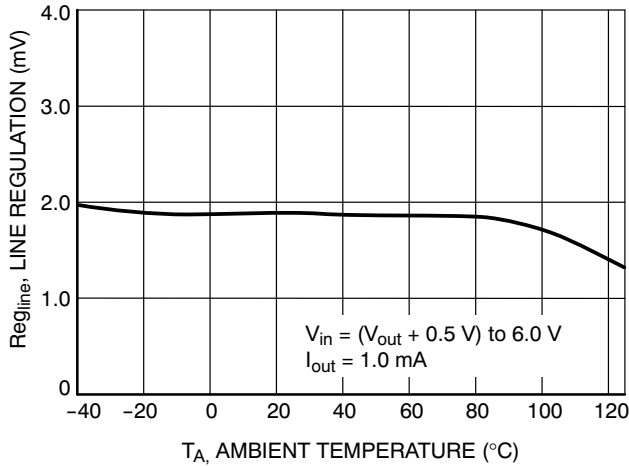

Figure 19. Line Regulation vs. Temperature

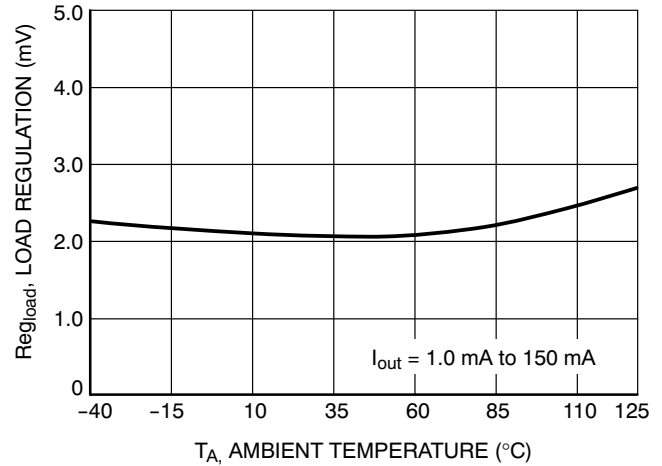

Figure 20. Load Regulation vs. Temperature

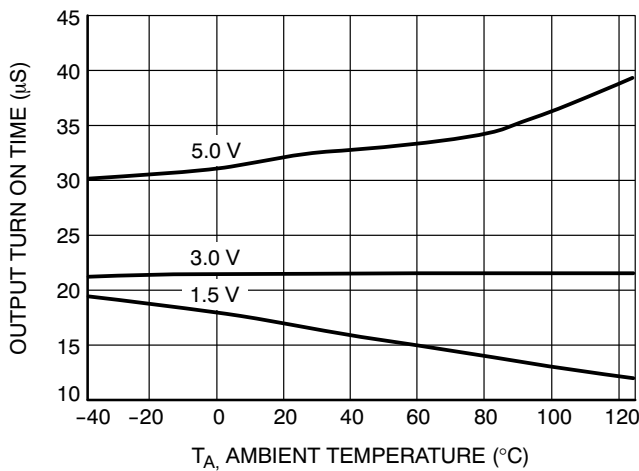

Figure 21. Output Turn On Time vs. Temperature

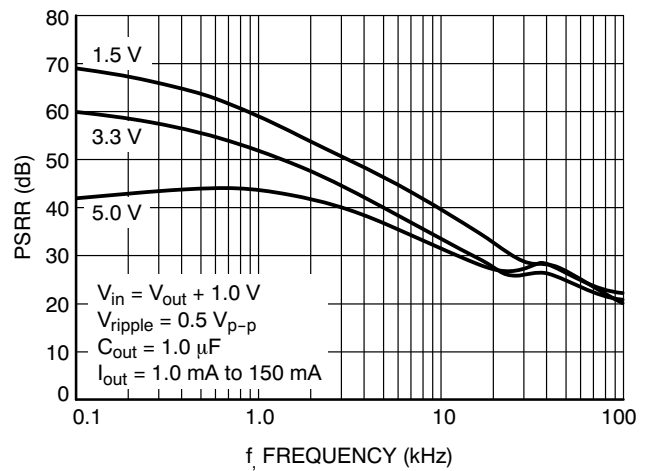

Figure 22. Power Supply Ripple Rejection vs. Frequency

NCP629

TYPICAL CHARACTERISTICS

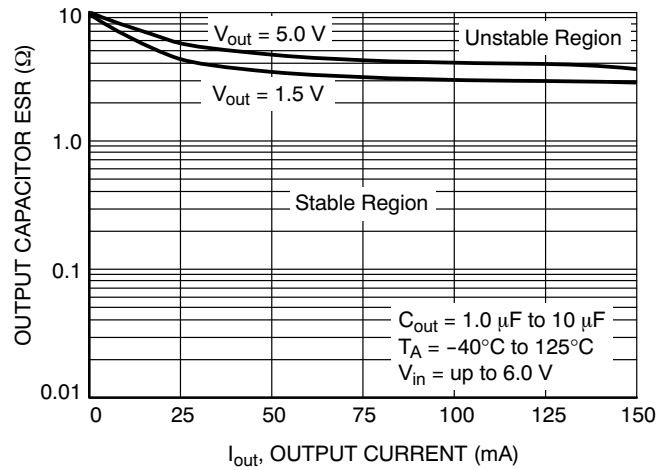

Figure 23. Output Stability with Output Capacitor ESR over Output Current

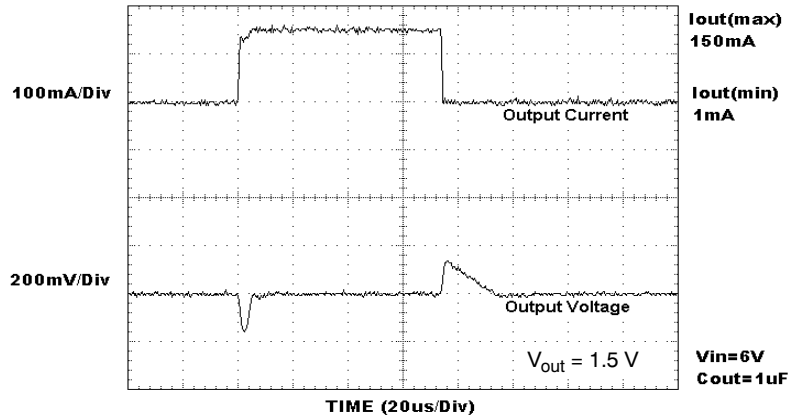

Figure 24. Load Transient Response ($1.0\ \mu\text{F}$)

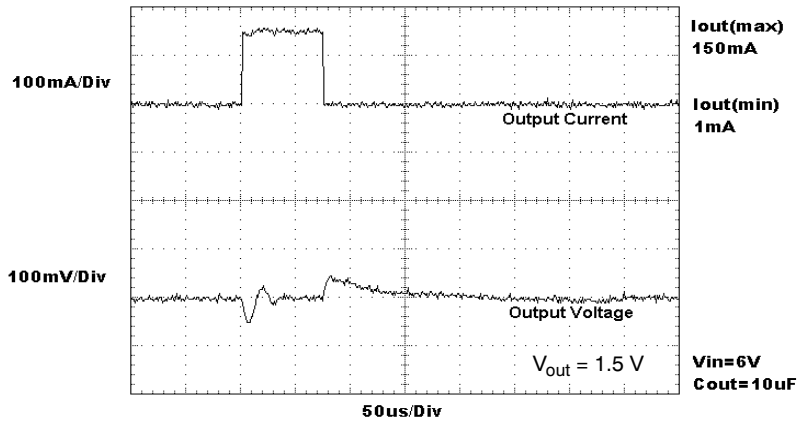

Figure 25. Load Transient Response ($10\ \mu\text{F}$)

DEFINITIONS

Load Regulation

The change in output voltage for a change in output load current at a constant temperature.

Dropout Voltage

The input/output differential at which the regulator output no longer maintains regulation against further reductions in input voltage. Measured when the output drops 2% below its nominal. The junction temperature, load current, and minimum input supply requirements affect the dropout level.

Output Noise Voltage

This is the integrated value of the output noise over a specified frequency range. Input voltage and output load current are kept constant during the measurement. Results are expressed in μV_{rms} or $\text{nV}/\sqrt{\text{Hz}}$.

Disable and Ground Current

Ground Current (I_{GND}) is the current that flows through the ground pin when the regulator operates with a load on its output. This consists of internal IC operation, bias, etc. It is actually the difference between the input current (measured through the LDO input pin) and the output load current. If the regulator has an input pin that reduces its internal bias and shuts off the output (enable/disable function), this term is called the disable current (I_{DIS}).

Line Regulation

The change in output voltage for a change in input voltage. The measurement is made under conditions of low dissipation or by using pulse techniques such that the average junction temperature is not significantly affected.

Line Transient Response

Typical output voltage overshoot and undershoot response when the input voltage is excited with a given slope.

Load Transient Response

Typical output voltage overshoot and undershoot response when the output current is excited with a given slope between low-load and high-load conditions.

Thermal Protection

Internal thermal shutdown circuitry is provided to protect the integrated circuit in the event that the maximum junction temperature is exceeded. When activated at typically 175°C, the regulator turns off. This feature is provided to prevent failures from accidental overheating.

Maximum Package Power Dissipation

The power dissipation level at which the junction temperature reaches its maximum operating value.

APPLICATIONS INFORMATION

The NCP629 series regulator is self-protected with internal thermal shutdown and internal current limit. Typical application circuit is shown in Figure 1.

Input Decoupling (C_{in})

A ceramic or tantalum 1.0 μF capacitor is recommended and should be connected close to the NCP629 package. Higher capacitance and lower ESR will improve the overall line transient response.

Output Decoupling (C_{out})

The NCP629 is a stable component and does not require a minimum Equivalent Series Resistance (ESR) for the output capacitor. The minimum output decoupling value is 1.0 μF and can be augmented to fulfill stringent load transient requirements. The regulator works with ceramic chip capacitors as well as tantalum devices. Typical

characteristics were measured with Murata ceramic capacitors GRM31MR71E105KA01 (1.0 μF , 25 V X7R, 1206). Larger values improve noise rejection and load regulation transient response. Figure 23 shows the stability region for a range of operating conditions and ESR values.

No-Load Regulation Considerations

The NCP629 contains an overshoot clamp circuit to improve transient response during a load current step release. When output voltage exceeds the nominal by approximately 20 mV, this circuit becomes active and clamps the output from further voltage increase. Tying the ENABLE pin to V_{in} will ensure that the part is active whenever the supply voltage is present, thus guaranteeing that the clamp circuit is active whenever leakage current is present.

NCP629

Noise Decoupling

The NCP629 is a low noise regulator and needs no external noise reduction capacitor. Unlike other low noise regulators which require an external capacitor and have slow startup times, the NCP629 operates without a noise reduction capacitor, has a typical 15 μ s startup delay and achieves a 50 μ V_{rms} overall noise level between 10 Hz and 100 kHz.

Enable Operation

The enable pin will turn the regulator on or off. The threshold limits are covered in the electrical characteristics table in this data sheet. The turn-on/turn-off transient voltage being supplied to the enable pin should exceed a slew rate of 10 mV/ μ s to ensure correct operation. If the enable function is not to be used then the pin should be connected to V_{in}.

Thermal

As power in the NCP629 increases, it might become necessary to provide some thermal relief. The maximum power dissipation supported by the device is dependent upon board design and layout. Mounting pad configuration on the PCB, the board material, and the ambient temperature affect the rate of junction temperature rise for the part. When the NCP629 has good thermal conductivity through the PCB, the junction temperature will be relatively low with high power applications. The maximum dissipation the NCP629 can handle is given by:

$$P_{D(MAX)} = \frac{T_{J(MAX)} - T_A}{R_{\theta JA}} \quad (\text{eq. 1})$$

Since T_J is not recommended to exceed 125°C, then the NCP629 soldered on 645 mm², 1 oz copper area, FR4 can dissipate up to 360 mW when the ambient temperature (T_A) is 25°C. See Figure 26 for R_{thJA} versus PCB area.

The power dissipated by the NCP629 can be calculated from the following equations:

$$P_D \approx V_{in}(I_{GND} @ I_{out}) + I_{out}(V_{in} - V_{out}) \quad (\text{eq. 2})$$

or

$$V_{in(MAX)} \approx \frac{P_{D(MAX)} + (V_{out} \times I_{out})}{I_{out} + I_{GND}} \quad (\text{eq. 3})$$

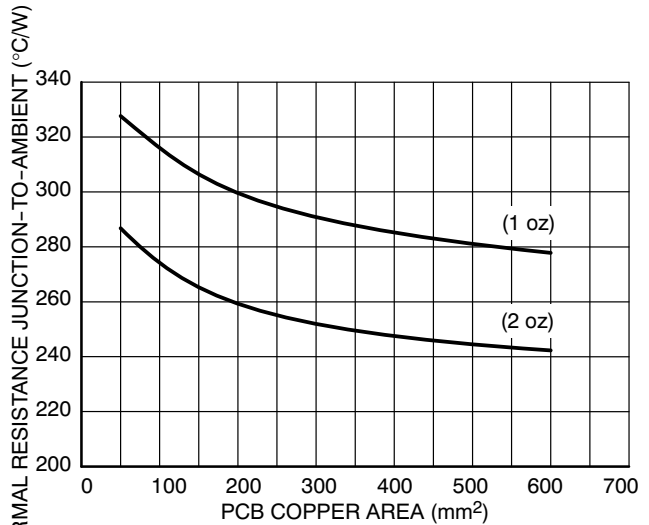

Figure 26. R_{thJA} vs. PCB Copper Area

Hints

V_{in} and GND printed circuit board traces should be as wide as possible. When the impedance of these traces is high, there is a chance to pick up noise or cause the regulator to malfunction. Place external components, especially the output capacitor, as close as possible to the NCP629, and make traces as short as possible.

DEVICE ORDERING INFORMATION

Device	Version	Marking Code	Package	Shipping [†]
NCP629FC15T2G	1.5 V	AAA	5 Pin Flip-Chip	3000/Tape & Reel
NCP629FC18T2G	1.8 V	AAC		
NCP629FC28T2G	2.8 V	AAD		
NCP629FC30T2G	3.0 V	AAE		
NCP629FC33T2G	3.3 V	AAF		
NCP629FC35T2G	3.5 V	AAG		
NCP629FC50T2G	5.0 V	AAH		

[†]For information on tape and reel specifications, including part orientation and tape sizes, please refer to our Tape and Reel Packaging Specifications Brochure, BRD8011/D.

MECHANICAL CASE OUTLINE

PACKAGE DIMENSIONS



SCALE 4:1

5 PIN FLIP-CHIP CASE 499AY-01 ISSUE O

DATE 06 JUN 2007

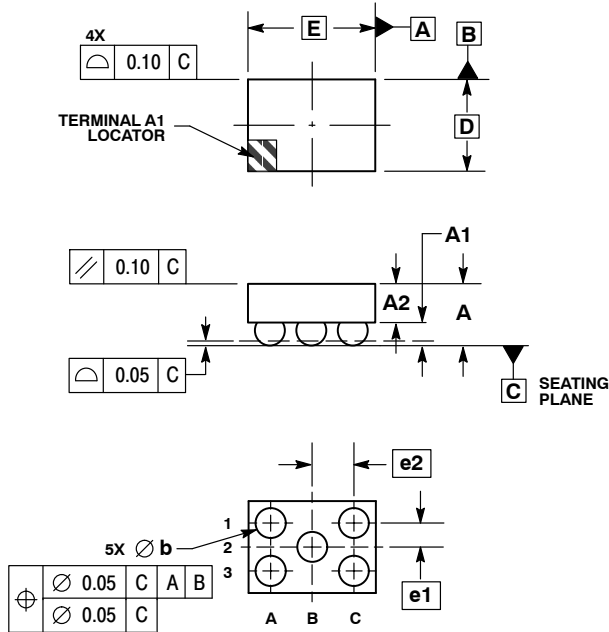

NOTES:

1. DIMENSIONING AND TOLERANCING PER ASME Y14.5M, 1994.
2. CONTROLLING DIMENSION: MILLIMETERS.
3. COPLANARITY APPLIES TO SPHERICAL CROWNS OF SOLDER BALLS.

MILLIMETERS			
DIM	MIN	NOM	MAX
A	0.475	0.530	0.585
A1	0.170	0.200	0.230
A2	0.305	0.330	0.355
b	0.220	0.250	0.270
D	1.028 BSC		
E	1.190 BSC		
e1	0.250 BSC		
e2	0.410 BSC		

SOLDERING FOOTPRINT*

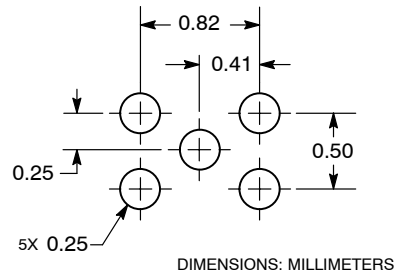

*For additional information on our Pb-Free strategy and soldering details, please download the ON Semiconductor Soldering and Mounting Techniques Reference Manual, SOLDERRM/D.

DOCUMENT NUMBER:	98AON24677D	Electronic versions are uncontrolled except when accessed directly from the Document Repository. Printed versions are uncontrolled except when stamped "CONTROLLED COPY" in red.
DESCRIPTION:	5 PIN FLIP-CHIP, 1.028X1.190	PAGE 1 OF 1

ON Semiconductor and are trademarks of Semiconductor Components Industries, LLC dba ON Semiconductor or its subsidiaries in the United States and/or other countries. ON Semiconductor reserves the right to make changes without further notice to any products herein. ON Semiconductor makes no warranty, representation or guarantee regarding the suitability of its products for any particular purpose, nor does ON Semiconductor assume any liability arising out of the application or use of any product or circuit, and specifically disclaims any and all liability, including without limitation special, consequential or incidental damages. ON Semiconductor does not convey any license under its patent rights nor the rights of others.

onsemi, **Onsemi**, and other names, marks, and brands are registered and/or common law trademarks of Semiconductor Components Industries, LLC dba "**onsemi**" or its affiliates and/or subsidiaries in the United States and/or other countries. **onsemi** owns the rights to a number of patents, trademarks, copyrights, trade secrets, and other intellectual property. A listing of **onsemi**'s product/patent coverage may be accessed at www.onsemi.com/site/pdf/Patent-Marking.pdf. **onsemi** reserves the right to make changes at any time to any products or information herein, without notice. The information herein is provided "as-is" and **onsemi** makes no warranty, representation or guarantee regarding the accuracy of the information, product features, availability, functionality, or suitability of its products for any particular purpose, nor does **onsemi** assume any liability arising out of the application or use of any product or circuit, and specifically disclaims any and all liability, including without limitation special, consequential or incidental damages. Buyer is responsible for its products and applications using **onsemi** products, including compliance with all laws, regulations and safety requirements or standards, regardless of any support or applications information provided by **onsemi**. "Typical" parameters which may be provided in **onsemi** data sheets and/or specifications can and do vary in different applications and actual performance may vary over time. All operating parameters, including "Typicals" must be validated for each customer application by customer's technical experts. **onsemi** does not convey any license under any of its intellectual property rights nor the rights of others. **onsemi** products are not designed, intended, or authorized for use as a critical component in life support systems or any FDA Class 3 medical devices or medical devices with a same or similar classification in a foreign jurisdiction or any devices intended for implantation in the human body. Should Buyer purchase or use **onsemi** products for any such unintended or unauthorized application, Buyer shall indemnify and hold **onsemi** and its officers, employees, subsidiaries, affiliates, and distributors harmless against all claims, costs, damages, and expenses, and reasonable attorney fees arising out of, directly or indirectly, any claim of personal injury or death associated with such unintended or unauthorized use, even if such claim alleges that **onsemi** was negligent regarding the design or manufacture of the part. **onsemi** is an Equal Opportunity/Affirmative Action Employer. This literature is subject to all applicable copyright laws and is not for resale in any manner.

ADDITIONAL INFORMATION

TECHNICAL PUBLICATIONS:

Technical Library: www.onsemi.com/design/resources/technical-documentation
onsemi Website: www.onsemi.com

ONLINE SUPPORT: www.onsemi.com/support

For additional information, please contact your local Sales Representative at www.onsemi.com/support/sales

