

# NCP6251

## Product Preview

# 2/3/4-Phase Controller for CPU Applications

The NCP6251 is a multiphase synchronous buck regulator controller designed to power the Core and Northbridge of an AMD microprocessor. The controller has a user configurable two, three, or four phase regulator for the Core and an independent single phase regulator to power the microprocessor Northbridge. The NCP6251 incorporates differential voltage sensing, differential phase current sensing, optional load-line voltage positioning, and programmable  $V_{DD}$  and  $V_{DDNB}$  offsets to provide accurately regulated power parallel- and serial-VID AMD processors. Dual-edge multiphase modulation provides the fastest initial response to dynamic load events. This reduces system cost by requiring less bulk and ceramic output capacitance to meet transient regulation specifications.

High performance operational error amplifiers are provided to simplify compensation of the  $V_{DD}$  and  $V_{DDNB}$  regulators. Dynamic Reference Injection further simplifies loop compensation by eliminating the need to compromise between response to load transients and response to VID code changes.

### Features

- Meets AMD's Hybrid VR Specifications
- Up to Four  $V_{DD}$  Phases
- Single-Phase  $V_{DDNB}$  Controller
- Dual-Edge PWM for Fastest Initial Response to Transient Loading
- High Performance Operational Error Amplifiers
- Internal Soft-Start and Slew Rate Limiting
- Dynamic Reference Injection (Patent #US07057381)
- DAC Range from 12.5 mV to 1.55 V
- $\pm 0.6\%$  DAC Accuracy from 0.8 V to 1.55 V
- $V_{DD}$  and  $V_{DD}$  Offset Ranges 0 mV – 800 mV
- True Differential Remote Voltage Sense Amplifiers
- Phase-to-Phase  $I_{DD}$  Current Balancing
- Differential Current Sense Amplifiers for Each Phase of Each Output
- "Lossless" Inductor Current Sensing for  $V_{DD}$  and  $V_{DDNB}$  Outputs
- Supports Load Lines (Droop) for  $V_{DD}$  and  $V_{DDNB}$  Outputs
- Oscillator Range of 100 kHz – 1 MHz
- Tracking Overvoltage Protection
- Output Inductor DCR-Based Over Current Protection for  $V_{DD}$  and  $V_{DDNB}$  Outputs
- Guaranteed Startup into Precharged Loads
- Temperature Range: 0°C to 70°C
- Two Stage Overcurrent Protection

### Applications

- Desktop Processors
- Server Processors
- High-End Notebook PCs

This document contains information on a product under development. ON Semiconductor reserves the right to change or discontinue this product without notice.



ON Semiconductor®

<http://onsemi.com>

### MARKING DIAGRAM

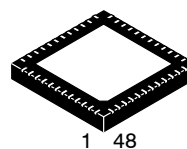

QFN48, 7x7  
CASE 485AJ

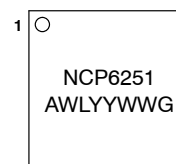

A = Assembly Location  
WL = Wafer Lot  
YY = Year  
WW = Work Week  
G = Pb-Free Package

### ORDERING INFORMATION

Device	Package	Shipping†
NCP6251MNR2G	QFN48 (Pb-Free)	2500 / Tape & Reel

†For information on tape and reel specifications, including part orientation and tape sizes, please refer to our Tape and Reel Packaging Specifications Brochure, BRD8011/D.

# NCP6251

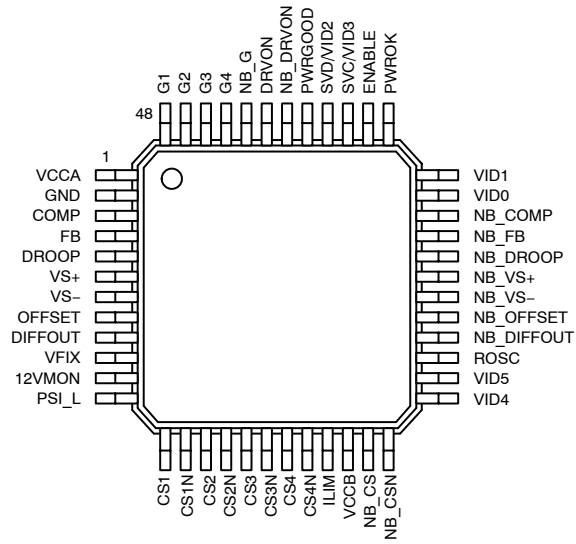

Figure 1. Pinout

# NCP6251

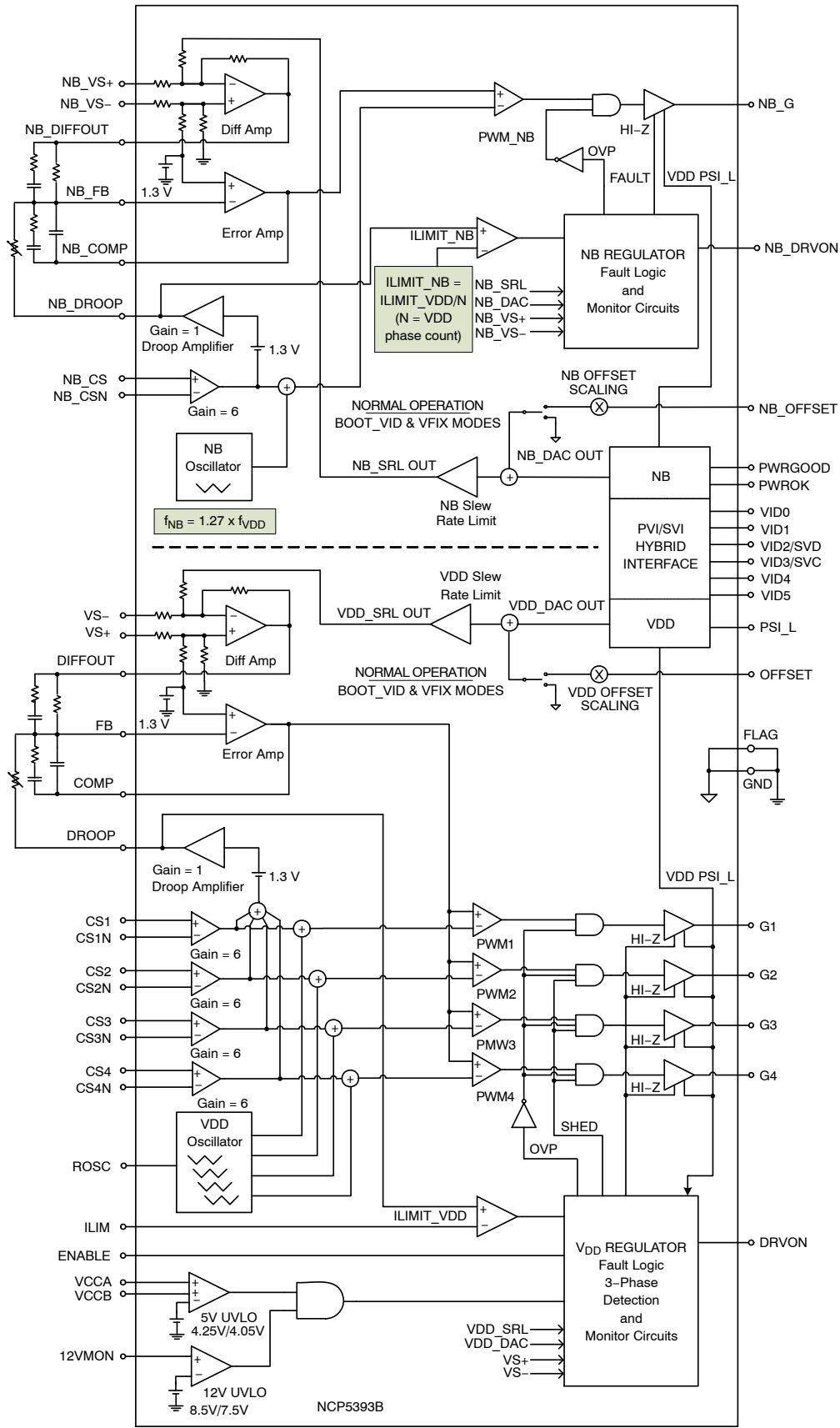

Figure 2. NCP6251 Block Diagram



# NCP6251

## NCP6251 PIN DESCRIPTIONS

Pin No.	Symbol	Description
1	VCCA	5 V supply pin for the NCP6251. The $V_{CC}$ bypassing capacitance must be connected between this pin and GND (preferably returned to the package flag).
2	GND	Small-signal power supply return. This pin should be tied directly to the package flag (exposed pad).
3	COMP	Output of the voltage error amplifier for the $V_{DD}$ regulator.
4	FB	Voltage error amplifier inverting input for the $V_{DD}$ regulator.
5	DROOP	Voltage output signal proportional to total current drawn from the $V_{DD}$ regulator. Used when load line operation ("droop") is desired.
6	VS+	Non-inverting input to the differential remote sense amplifier for the $V_{DD}$ regulator.
7	VS-	Inverting input to the differential remote sense amplifier for the $V_{DD}$ regulator.
8	OFFSET	Input for offset voltage to be added to the $V_{DD}$ DAC's output voltage. Ground this pin for zero $V_{DD}$ offset.
9	DIFFOUT	Output of the differential remote sense amplifier for the $V_{DD}$ regulator.
10	VFIX	When pulled low, this pin causes the levels on the SVC (VID3) and SVD (VID2) pins to be decoded as a two-bit DAC code, which controls the $V_{DD}$ and VDDNB outputs. Internally pulled high by 5 $\mu$ A to $V_{CC}$
11	12VMON	UVLO monitor input for the 12 V power rail.
12	PSI_L	Determines number of phases operating in PSI_L mode. Phase shed count is locked upon ENABLE assertion. After soft-start, becomes power saving control in PVID mode. Low = phase shed operation, High = normal operation.
13	CS1	Non-inverting input to current sense amplifier #1 for the $V_{DD}$ regulator. See Table: "Pin Connections vs. Phase Count"
14	CS1N	Inverting input to current sense amplifier #1 for the $V_{DD}$ regulator. See Table: "Pin Connections vs. Phase Count"
15	CS2	Non-inverting input to current sense amplifier #2 for the $V_{DD}$ regulator. See Table: "Pin Connections vs. Phase Count"
16	CS2N	Inverting input to current sense amplifier #2 for the $V_{DD}$ regulator. See Table: "Pin Connections vs. Phase Count"
17	CS3	Non-inverting input to current sense amplifier #3 for the $V_{DD}$ regulator. See Table: "Pin Connections vs. Phase Count"
18	CS3N	Inverting input to current sense amplifier #3 for the $V_{DD}$ regulator. See Table: "Pin Connections vs. Phase Count"
19	CS4	Non-inverting input to current sense amplifier #4 for the $V_{DD}$ regulator. See Table: "Pin Connections vs. Phase Count"
20	CS4N	Inverting input to current sense amplifier #4 for the $V_{DD}$ regulator. See Table: "Pin Connections vs. Phase Count"
21	ILIM	Overcurrent shutdown threshold for $V_{DD}$ and VDDNB. A resistor divider from ROSC to GND is typically used to develop an appropriate voltage on $I_{LIM}$ . This will set the two-stage over current protection, $I_{LIM1}$ and $I_{LIM2}$ . $I_{LIM1}$ is the first stage OCP with a delayed latch response. $I_{LIM2}$ is a higher value, typically $1.3 \times I_{LIM1}$ , it is an immediate latch response.
22	VCCB	5 V supply pin. Tie this pin to VCCA (Pin 1).
23	NB_CS	Non-inverting input to the current sense amplifier for the VDDNB regulator
24	NB_CSN	Inverting input to the current sense amplifier for the VDDNB regulator
25	VID4	Parallel Voltage ID DAC Input 4. Not used in SVI mode.
26	VID5	Parallel Voltage ID DAC Input 5. Not used in SVI mode.
27	ROSC	A resistance from this pin to ground programs the $V_{DD}$ and VDDNB oscillator frequencies. This pin supplies a trimmed output voltage of 2 V.
28	NB_DIFFOUT	Output of the differential remote sense amplifier for the VDDNB regulator.
29	NB_OFFSET	Input for offset voltage to be added to the VDDNB DAC's output voltage. Ground this pin for zero VDDNB offset.

# NCP6251

## NCP6251 PIN DESCRIPTIONS

Pin No.	Symbol	Description
30	NB_VS-	Inverting input to the differential remote sense amplifier for the VDDNB regulator.
31	NB_VS+	Non-inverting input to the differential remote sense amplifier for the VDDNB regulator.
32	NB_DROOP	Voltage output signal proportional to total current drawn from the VDDNB regulator. Used when load line operation ("droop") is desired.
33	NB_FB	Voltage error amplifier inverting input for the V <sub>DDNB</sub> regulator.
34	NB_COMP	Output of the voltage error amplifier for the V <sub>DDNB</sub> regulator.
35	VID0	Parallel Voltage ID DAC Input 0. Not used in SVI mode.
36	VID1	Parallel Voltage ID DAC Input 1. Also used for PVI or SVI mode selection.
37	PWROK	System power supplies status input. Used in SVI mode only.
38	ENABLE	High = Run, Low = Standby/Reset.
39	VID3/SVC	Parallel Voltage ID DAC Input 1. Also used in SVI mode.
40	VID2/SVD	Parallel Voltage ID DAC Input 1. Also used in SVI mode.
41	PWRGOOD	Open drain output. High indicates that the active output(s) are within specification. Internally pulled high by 5 $\mu$ A to V <sub>CC</sub>
42	NB_DRVON	Bidirectional Gate Drive Enable to the gate driver for the V <sub>DDNB</sub> regulator.
43	DRVON	Bidirectional Gate Drive Enable to gate drivers for the V <sub>DD</sub> regulator.
44	NB_G	PWM output to the V <sub>DDNB</sub> gate driver.
45	G4	PWM output #4. See Table: "Pin Connections vs. Phase Count"
46	G3	PWM output #3. See Table: "Pin Connections vs. Phase Count"
47	G2	PWM output #2. See Table: "Pin Connections vs. Phase Count"
48	G1	PWM output #1. See Table: "Pin Connections vs. Phase Count"
FLAG	PGND	High-current power supply return via metal pad (flag) underneath package. The package flag should be tied directly to Pin 2.

## PIN CONNECTIONS VS. PHASE COUNT

Number of Phases	G4	G3	G2	G1	CS4 & CS4N	CS3 & CS3N	CS2 & CS2N	CS1 & CS1N
4	Phase 4 Out	Phase 3 Out	Phase 2 Out	Phase 1 Out	Phase 4 CS Input	Phase 3 CS Input	Phase 2 CS Input	Phase 1 CS Input
3	Tie to GND	Phase 3 Out	Phase 2 Out	Phase 1 Out	Tie to GND or V <sub>DD</sub>	Phase 3 CS Input	Phase 2 CS Input	Phase 1 CS Input
2	Tie to GND	Phase 2 Out	Tie to GND	Phase 1 Out	Tie to GND or V <sub>DD</sub>	Phase 2 CS input	Tie to GND or V <sub>DD</sub>	Phase 1 CS Input

# NCP6251

## ABSOLUTE MAXIMUM RATINGS ELECTRICAL INFORMATION

Pin Symbol	V <sub>MAX</sub>	V <sub>MIN</sub>	I <sub>SOURCE</sub>	I <sub>SINK</sub>
12VMON	25 V	-0.3 V	N/A	50 μA
VCC	7.0 V	-0.3 V	N/A	10 mA
COMP, NB_COMP	5.5 V	-0.3 V	10 mA	10 mA
DROOP, NB_DROOP	5.5 V	-0.3 V	5 mA	5 mA
DIFFOUT, NB_DIFFOUT	5.5 V	-0.3 V	20 mA	20 mA
DRVON, NB_DRVON	5.5 V	-0.3 V	5 mA	10 mA
PWRGOOD	5.5 V	-0.3 V	N/A	20 mA
VS+, NB_VS+	3 V	-0.3 V	1 mA	1 mA
VS-, NB_VS-	0.3 V	-0.3 V	1 mA	1 mA
ROSC	5.5 V	-0.3 V	1 mA	N/A
All Other Pins	5.5 V	-0.3 V	N/A	N/A

Stresses exceeding Maximum Ratings may damage the device. Maximum Ratings are stress ratings only. Functional operation above the Recommended Operating Conditions is not implied. Extended exposure to stresses above the Recommended Operating Conditions may affect device reliability.

NOTE: All signals are referenced to GND unless noted otherwise.

## THERMAL INFORMATION

Rating	Symbol	Value	Unit
Thermal Characteristic, QFN Package (Note 1)	R <sub>θJA</sub>	30.5	°C/W
Operating Junction Temperature Range (Note 2)	T <sub>J</sub>	0 to 125	°C
Operating Ambient Temperature Range	T <sub>A</sub>	0 to 70	°C
Maximum Storage Temperature Range	T <sub>STG</sub>	-55 to +150	°C
Moisture Sensitivity Level, QFN Package	MSL	1	

\* The maximum package power dissipation must be observed.

1. JESD 51-5 (1S2P Direct-Attach Method) with 0 LFM.
2. JESD 51-7 (1S2P Direct-Attach Method) with 0 LFM.

# NCP6251

**ELECTRICAL CHARACTERISTICS** (Unless otherwise stated:  $0^{\circ}\text{C} \leq T_A \leq 70^{\circ}\text{C}$ ;  $4.75\text{ V} \leq V_{CC} \leq 5.25\text{ V}$ ; All DAC Codes;  $C_{VCC} = 0.1\ \mu\text{F}$ )

Parameter	Test Conditions	Min	Typ	Max	Unit
<b>ERROR AMPLIFIERS</b> ( $V_{DD}$ & $V_{DDNB}$ )					
Input Bias Current		-200	-	200	nA
Input Offset Voltage (Note 3)	$V_+ = V_- = 1.3\text{V}$	-1.0	-	1.0	mV
Open Loop DC Gain	$C_L = 60\ \text{pF}$ to GND, $R_L = 10\ \text{k}\Omega$ to GND	-	80	-	dB
Open Loop Unity Gain Bandwidth	$C_L = 60\ \text{pF}$ to GND, $R_L = 10\ \text{k}\Omega$ to GND	-	15	-	MHz
Open Loop Phase Margin	$C_L = 60\ \text{pF}$ to GND, $R_L = 10\ \text{k}\Omega$ to GND	-	70	-	deg
Slew Rate	$\Delta V_{IN} = 100\ \text{mV}$ , $A_V = -10\ \text{V/V}$ , $1.5\ \text{V} < V_{COMP} < 2.5\ \text{V}$ , $C_L = 60\ \text{pF}$ , DC Loading = $\pm 125\ \mu\text{A}$	-	5	-	V/ $\mu\text{s}$
Maximum Output Voltage	10 mV of Overdrive, $I_{SOURCE} = 2.0\ \text{mA}$	3.5	-	-	V
Minimum Output Voltage	10 mV of Overdrive, $I_{SINK} = 2.0\ \text{mA}$	-	-	1.0	V
Output Source Current (Note 3)	10 mV of Overdrive, $V_{OUT} = 3.5\ \text{V}$	-	2	-	mA
Output Sink Current (Note 3)	10 mV of Overdrive, $V_{OUT} = 1.0\ \text{V}$	-	2	-	mA

## DIFFERENTIAL SUMMING AMPLIFIERS

 ( $V_{DD}$  &  $V_{DDNB}$ )

VS- Input Bias Current	VS- Voltage at 0 V		33		$\mu\text{A}$
VS+ Input Resistance	DRVON = Low		1.0		$\text{k}\Omega$
	DRVON = High		7		
VS+ Input Bias Voltage	DRVON = Low		0.37		V
	DRVON = High		0.05		
VS+ Input Voltage Range (Note 3)		-0.3	-	3.0	V
VS- Input Voltage Range (Note 3)		-0.3	-	0.3	V
-3dB Bandwidth (Note 3)	$C_L = 80\ \text{pF}$ to GND, $R_L = 10\ \text{k}\Omega$ to GND		15		MHz
DC gain, VS+ to DIFFOUT	VS+ to VS- = 0.5 V to 2.35 V	0.982	1.0	1.022	V/V
DAC Accuracy (Measured at VS+)	Closed Loop Measurement, Error Amplifier Inside the Loop. $1.0125\ \text{V} \leq V_{DAC} \leq 1.5500\ \text{V}$ $0.8000\ \text{V} \leq V_{DAC} \leq 1.0000\ \text{V}$ $12.5\ \text{mV} \leq V_{DAC} \leq 0.8000\ \text{V}$	-0.5 -5 -8	- - -	0.5 5 8	% mV mV
Slew Rate	$\Delta V_{IN} = 100\ \text{mV}$ , $\Delta V_{OUT} = 1.3\ \text{V} - 1.2\ \text{V}$		10		V/ $\mu\text{s}$
Maximum Output Voltage	$I_{SOURCE} = 2\ \text{mA}$	2.0			V
Minimum Output Voltage	$I_{SINK} = 2\ \text{mA}$			0.5	V
Output source current (Note 3)	$V_{OUT} = 3\ \text{V}$		2.0		mA
Output sink current (Note 3)	$V_{OUT} = 0.5\ \text{V}$		2.0		mA

## DROOP AMPLIFIERS

 ( $V_{DD}$  &  $V_{DDNB}$ )

Gain from Current Sense Input to Droop Amplifier Output	$0\ \text{mV} < (CS_x - CS_{xN}) < 60\ \text{mV}$	5.7	6.0	6.3	V/V
Droop Amplifier DC Output Voltage	$CS_x = CS_{xN} = 1.3\ \text{V}$		1.3		V
Slew Rate	$C_L = 20\ \text{pF}$ to GND, $R_L = 1\ \text{k}\Omega$ to GND	-	5.0	-	V/ $\mu\text{s}$
Maximum Output Voltage	$I_{SOURCE} = 4.0\ \text{mA}$	3.0	-	-	V
Minimum Output Voltage	$I_{SINK} = 1.0\ \text{mA}$	-	-	1.0	V
Output Source Current (Note 3)	$V_{OUT} = 3.0\ \text{V}$	-	4.0	-	mA
Output Sink Current (Note 3)	$V_{OUT} = 1.0\ \text{V}$	-	1.0	-	mA

3. Guaranteed by design. Not production tested.

4. For guaranteed Phase Shed Count upon ENABLE assertion, set the PSI\_L pin voltage range between the values shown for Min and Max per the intended phase shed count.



# NCP6251

**ELECTRICAL CHARACTERISTICS** (Unless otherwise stated:  $0^{\circ}\text{C} \leq T_A \leq 70^{\circ}\text{C}$ ;  $4.75\text{ V} \leq V_{\text{CC}} \leq 5.25\text{ V}$ ; All DAC Codes;  $C_{\text{VCC}} = 0.1\ \mu\text{F}$ )

Parameter	Test Conditions	Min	Typ	Max	Unit
<b>CURRENT SENSE AMPLIFIERS</b> ( $V_{\text{DD}}$ & $V_{\text{DDNB}}$ )					
Input Bias Current	$\text{CSx} = \text{CSxN} = 1.4\text{ V}$	-50	-	50	nA
Common Mode Input Voltage Range		-0.3	-	2.6	V
Differential Mode Input Voltage Range (Note 3)		-120	-	120	mV
Input Offset Voltage (Note 3)	$\text{CSx} = \text{CSxN} = 1.00\text{ V}$	-1.0	-	1.0	mV
Gain from Current Sense Input to PWM Comparator	$0\text{ mV} < (\text{CSx} - \text{CSxN}) < 60\text{ mV}$	5.0	6.0	7.0	V/V
<b>INTERNAL OFFSET VOLTAGE</b>					
Voltage at Error Amplifier Non-Inverting Inputs		-	1.3	-	V
<b>DRVON &amp; NB_DRVON</b>					
Output Voltage (High)	Sourcing $500\ \mu\text{A}$	3.0	-	-	V
Output Voltage (Low)	Sinking $500\ \mu\text{A}$	-	-	0.7	V
Delay Time	Propagation Delays	-	10	-	ns
Active Internal Pull-up Resistance	Sourcing $500\ \mu\text{A}$	-	2.0	-	k $\Omega$
Active Internal Pull-down Resistance	Sinking $500\ \mu\text{A}$	-	150	-	$\Omega$
Rise Time	$C_L (\text{PCB}) = 20\ \text{pF}$ , $\Delta V_{\text{OUT}} = 10\%$ to $90\%$	-	130	-	ns
Fall Time	$C_L (\text{PCB}) = 20\ \text{pF}$ , $\Delta V_{\text{OUT}} = 10\%$ to $90\%$	-	15	-	ns
<b><math>V_{\text{DD}}</math> PWM OSCILLATOR</b>					
Switching Frequency Range		100	-	900	kHz
Switching Frequency Accuracy 2- or 4-phase	ROSC = $49.9\ \text{k}\Omega$ ROSC = $24.9\ \text{k}\Omega$ ROSC = $10\ \text{k}\Omega$	196 380 760	- - -	226 420 981	kHz
Switching Frequency Accuracy 3-phase	ROSC = $49.9\ \text{k}\Omega$ ROSC = $24.9\ \text{k}\Omega$ ROSC = $10\ \text{k}\Omega$	196 380 760	- - -	226 420 981	kHz
ROSC Output Voltage	$10\ \mu\text{A} \leq \text{IROSC} \leq 200\ \mu\text{A}$	1.94	2.0	2.06	V
<b><math>V_{\text{DDNB}}</math> PWM OSCILLATOR</b>					
Switching Frequency		-	1.25	-	$\times f_{\text{VDD}}$
<b>PWM COMPARATORS</b> ( $V_{\text{DD}}$ & $V_{\text{DDNB}}$ )					
Minimum Pulse Width (Note 3)	$F_{\text{SW}} = 800\ \text{kHz}$	-	30	-	ns
Propagation Delay (Note 3)	$\pm 20\ \text{mV}$ of Overdrive	-	10	-	ns
Magnitude of the PWM Ramp		-	1.0	-	V
0% Duty Cycle	COMP Voltage at which the PWM Outputs Remain LOW	-	0.2	-	V
100% Duty Cycle	COMP Voltage at which the PWM Outputs Remain HIGH	-	1.2	-	V
PWM Phase Angle Error	Between Adjacent Phases	-15		+15	$^{\circ}$
<b>PWRGOOD OUTPUT</b>					
PWRGOOD Output Voltage (Low)	$I_{\text{PGD}} = 5\ \text{mA}$	-	-	0.4	V
PWRGOOD Rise Time	External Pullup of $1\ \text{k}\Omega$ to $5\ \text{V}$ $C_{\text{TOTAL}} = 45\ \text{pF}$ , $\Delta V_{\text{OUT}} = 10\%$ to $90\%$	-	125	-	ns
PWRGOOD High-State Leakage	$V_{\text{PWRGOOD}} = 5.25\ \text{V}$	-	-	1	$\mu\text{A}$

3. Guaranteed by design. Not production tested.

4. For guaranteed Phase Shed Count upon ENABLE assertion, set the PSI\_L pin voltage range between the values shown for Min and Max per the intended phase shed count.

# NCP6251

## ELECTRICAL CHARACTERISTICS (Unless otherwise stated: $0^{\circ}\text{C} \leq T_A \leq 70^{\circ}\text{C}$ ; $4.75\text{ V} \leq V_{\text{CC}} \leq 5.25\text{ V}$ ; All DAC Codes; $C_{\text{VCC}} = 0.1\ \mu\text{F}$ )

Parameter	Test Conditions	Min	Typ	Max	Unit
-----------	-----------------	-----	-----	-----	------

### PWRGOOD OUTPUT

PWRGOOD Upper Threshold	$V_{\text{OUT}}$ Increasing, DAC = 1.3 V (Wrt DAC)	–	300	–	mV
PWRGOOD Lower Threshold	$V_{\text{OUT}}$ Decreasing, DAC = 1.3 V	–	350	–	mV

### PWM OUTPUTS ( $V_{\text{DD}}$ & $V_{\text{DDNB}}$ )

Output Voltage (High)	Sourcing 500 $\mu\text{A}$	3.0	–	$V_{\text{CC}}$	V
Output Voltage (Low)	Sinking 500 $\mu\text{A}$	–	–	0.15	V
Rise and Fall Times	$C_L = 50\ \text{pF}$ , 0.7 V to 3.0 V or 3.0 V to 0.7 V	–	15	–	ns
Tri-State Output Leakage	$G_x = 2.5\text{ V}$ ( $x = 1-4$ or NB)	–1.5	–	1.5	$\mu\text{A}$
Output Impedance – HIGH or LOW State	Resistance to $V_{\text{CC}}$ or GND	–	50	–	$\Omega$

### VDD REGULATOR 2/3/4 PHASE DETECTION

Gate Pin Source Current		–	80	–	$\mu\text{A}$
Gate Pin Threshold Voltage		–	250	–	mV
Phase Detect Timer		–	20	–	$\mu\text{s}$

### SLEW RATE LIMITERS

Soft-Start Slew Rate	In Any Mode During Soft-Start	0.64	0.8	0.96	mV/ $\mu\text{s}$
Slew Rate Limit	In Any Mode after Soft-Start Completes	–	3.25	–	mV/ $\mu\text{s}$

**VID INPUTS** (Note: In SVI Mode, VID[2] = Bidirectional “SVD” Line and VID[3] = “SVC” Clock Input supporting AMD’s recommendation in either fast-mode I2C or high-speed mode I2C)

VID Input Voltage (High)	$V_{\text{HIGH}}$	0.9	–	–	V
VID Input Voltage (Low)	$V_{\text{LOW}}$	–	–	0.6	V
VID Hysteresis	$V_{\text{HIGH}} - V_{\text{LOW}}$ or $V_{\text{LOW}} - V_{\text{HIGH}}$	–	100	–	mV
Input Pulldown Current	$V_{\text{IN}} = 0.6\text{ V} - 1.9\text{ V}$	–	15	–	$\mu\text{A}$
SVD Output Voltage (Low)	In SVI Mode, $I_{\text{SINK}} = 5\text{ mA}$	0	–	0.25	V

### ENABLE INPUT

ENABLE Input Voltage (High)	$V_{\text{HIGH}}$	2.0	–	–	V
ENABLE Input Voltage (Low)	$V_{\text{LOW}}$	–	–	0.8	V
Enable Hysteresis	Low – High or High – Low	–	200	–	mV
Enable Input Pull-Up Current	Internal Pullup to $V_{\text{CC}}$	–	15	–	$\mu\text{A}$

### VFIXEN INPUT (Active-Low Input)

VFIXEN Input Voltage (High)	$V_{\text{HIGH}}$	0.9	–	–	V
VFIXEN Input Voltage (Low)	$V_{\text{LOW}}$	–	–	0.6	V
VFIXEN Hysteresis	Low – High or High – Low	–	100	–	mV
VFIXEN Input Pull-Up Current	Internal Pullup to $V_{\text{CC}}$	–	15	–	$\mu\text{A}$

### PSI\_L (Power Saving Phase Shed and Control, Active Low) (This pin is used in PVI mode only)

PSI_L Phase Shed Count (Note 4)	Before Enable Assertion, No Phase Shedding while PSI_L Active	–	–	0.6	V
PSI_L Phase Shed Count (Note 4)	Before ENABLE Assertion, Phase Shed to 2 Phases	0.9	–	1.1	V
PSI_L Phase Shed Count (Note 4)	Before ENABLE Assertion, Phase Shed to 1 Phase	1.3	–	–	V
PSI_L Input Voltage (High)	After Soft-Start, $V_{\text{HIGH}}$	0.9	–	–	V
PSI_L Input Voltage (Low)	After Soft-Start, $V_{\text{LOW}}$	–	–	0.6	V
PSI_L Hysteresis	After Soft-Start, $V_{\text{HIGH}} - V_{\text{LOW}}$ or $V_{\text{LOW}} - V_{\text{HIGH}}$	–	100	–	mV

3. Guaranteed by design. Not production tested.

4. For guaranteed Phase Shed Count upon ENABLE assertion, set the PSI\_L pin voltage range between the values shown for Min and Max per the intended phase shed count.

# NCP6251

**ELECTRICAL CHARACTERISTICS** (Unless otherwise stated:  $0^{\circ}\text{C} \leq T_A \leq 70^{\circ}\text{C}$ ;  $4.75\text{ V} \leq V_{\text{CC}} \leq 5.25\text{ V}$ ; All DAC Codes;  $C_{\text{VCC}} = 0.1\ \mu\text{F}$ )

Parameter	Test Conditions	Min	Typ	Max	Unit
<b>CURRENT LIMIT</b>					
Current Sense Amp to $I_{\text{LIM}}$ Gain	$20\text{ mV} < (\text{CSx} - \text{CSxN}) < 60\text{ mV}$ (CS inputs tied)	5.7	6.0	6.3	V/V
$I_{\text{LIM}}$ Pin Input Bias Current		–	–	0.5	$\mu\text{A}$
$I_{\text{LIM}}$ Pin Working Voltage Range (Note 3)		0.2	–	2.0	V
$I_{\text{LIM}}$ Offset Voltage	Offset extrapolated to $\text{CSx} - \text{CSxN} = 0\text{ V}$ , and referred to the $I_{\text{LIM}}$ pin	–	30	–	mV
Delay		–	600	–	ns
VDDNB Current Limit Coefficient	$= N \times V_{\text{NBILIM}} / V_{\text{ILIM}}$ , where $N$ = number of VDD phases, and $V_{\text{NBILIM}}$ is the equivalent voltage threshold for NB Current Limit resulting from $V_{\text{ILIM}}$ .	–	1.0	–	V
$I_{\text{LIM}2}$ to $I_{\text{LIM}1}$ Ratio		–	1.3	–	
<b>OFFSET INPUTS</b> ( $V_{\text{DD}}$ & $V_{\text{DDNB}}$ )					
Output Offset Voltage Above VDAC		0	–	800	mV
<b>OUTPUT OVERVOLTAGE PROTECTION</b> ( $V_{\text{DD}}$ & $V_{\text{DDNB}}$ )					
Over Voltage Threshold	In normal operation, with no VID changes	$V_{\text{DAC}} + 220$	$V_{\text{DAC}} + 235$	$V_{\text{DAC}} + 250$	mV
<b>VCCA UNDERVOLTAGE PROTECTION</b>					
VCCA UVLO Start Threshold		4.0	4.25	4.5	V
VCCA UVLO Stop Threshold		3.8	4.05	4.3	V
VCCA UVLO Hysteresis			200		mV
<b>INPUT SUPPLY CURRENT</b>					
VCC Operating Current	ENABLE held Low, No PWM operation	–	25	35	mA
<b>12VMON</b>					
12VMON (High Threshold)		8	8.5	9	V
12VMON (Low Threshold)		7	7.5	8	V
12VMON Hysteresis	Low – High or High – Low		1.0		V

3. Guaranteed by design. Not production tested.

4. For guaranteed Phase Shed Count upon ENABLE assertion, set the  $\text{PSI\_L}$  pin voltage range between the values shown for Min and Max per the intended phase shed count.

## TYPICAL CHARACTERISTICS

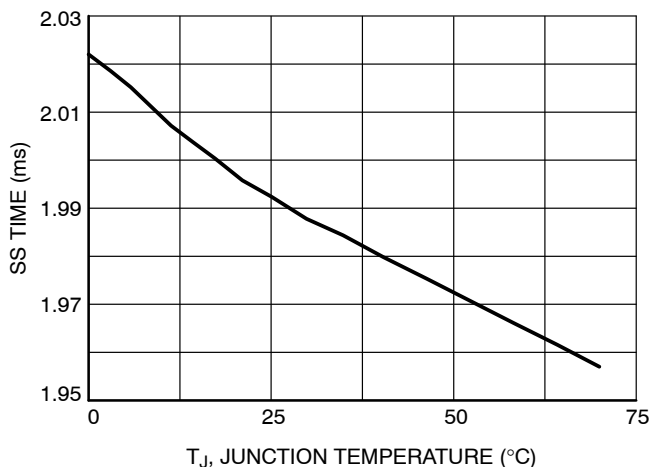

Figure 1. SS Time vs. Temperature

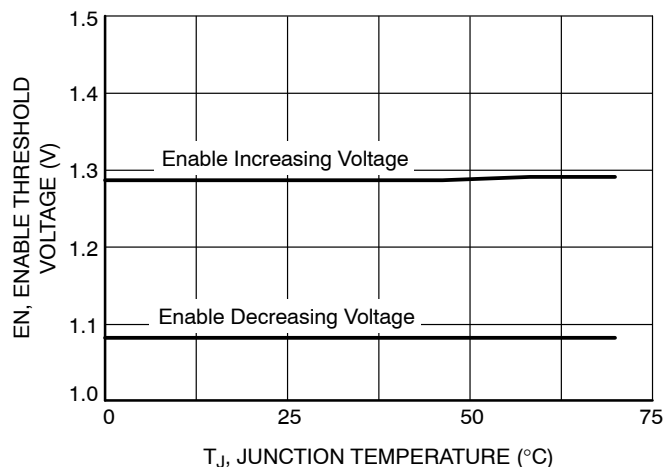

Figure 2. Enable Threshold Voltage vs. Temperature

TYPICAL CHARACTERISTICS

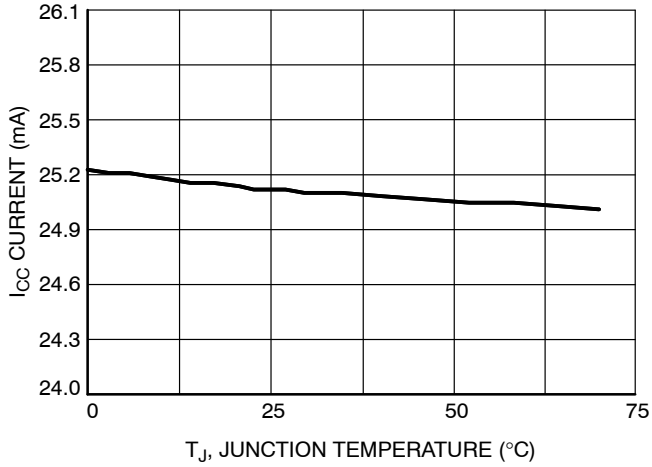

Figure 3. I<sub>CC</sub> Current vs. Temperature

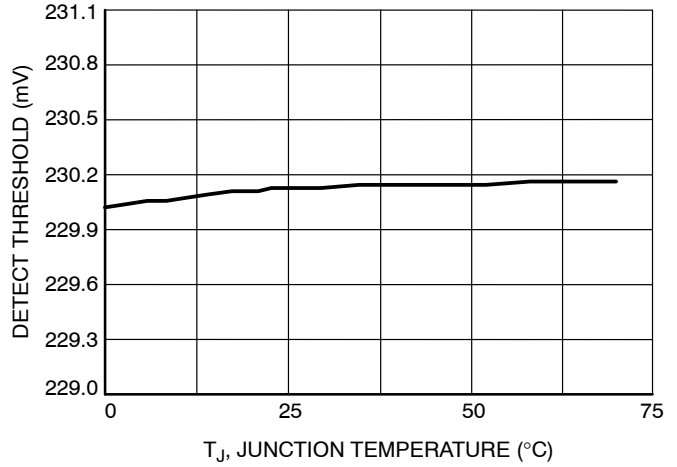

Figure 4. 2/3/4 Phase Detection Threshold vs. Temperature

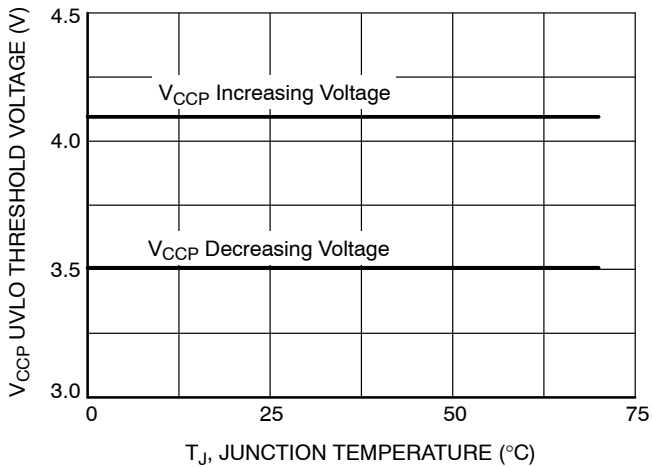

Figure 5. V<sub>CCP</sub> Undervoltage Lockout Threshold Voltage vs. Temperature

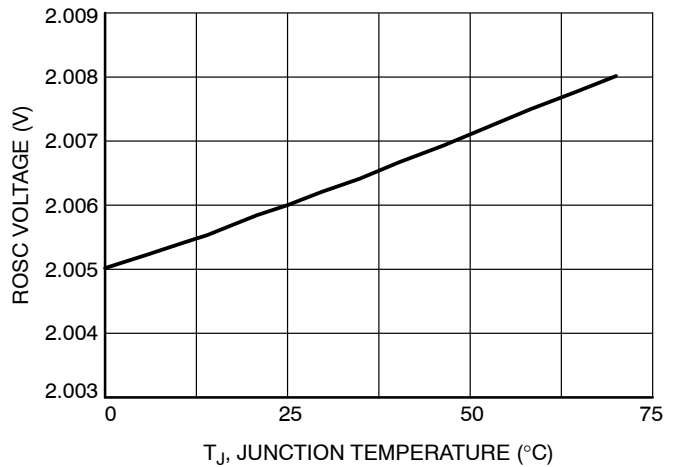

Figure 6. ROSC Voltage vs. Temperature

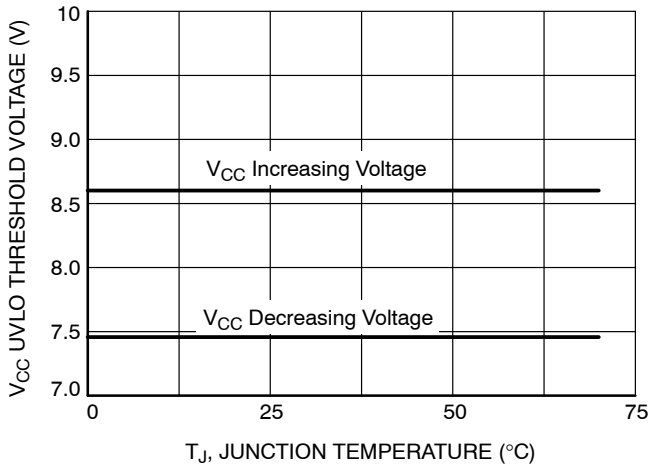

Figure 7. 12VMON Undervoltage Lockout Threshold Voltage vs. Temperature

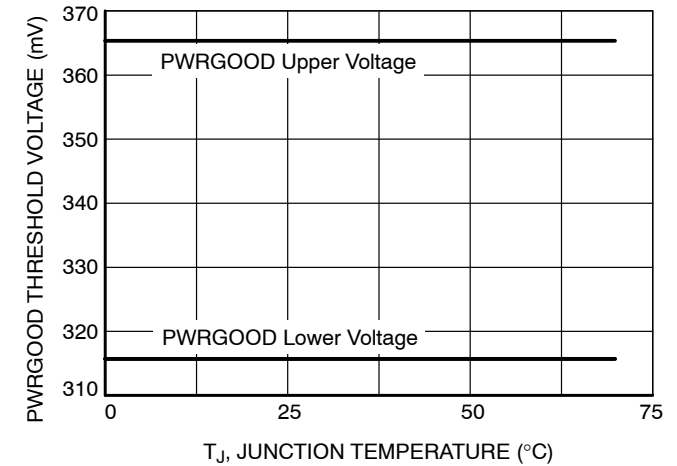

Figure 8. PWRGOOD Voltage vs. Temperature

## Functional Description

### General

NCP6251 is a universal CPU hybrid power Controller compatible with both Parallel VID interface (PVI) and Serial VID interface (SVI) protocols for AMD Processors. The Controller implements a single-phase control architecture to provide the Northbridge (NB) voltage on the same chip. For the CORE section, programmable 2- to-4 phase featuring Dual-Edge multiphase architecture is implemented. It embeds two independent controllers for CPU CORE and the integrated NB, each one with its set of protections.

The NCP6251 incorporates differential voltage sensing, differential phase current sensing, optional load-line voltage positioning, and programmable VDD and VDDNB offsets to provide accurately regulated power parallel- and serial-VID AMD processors. Dual-edge multiphase modulation provides the fastest initial response to dynamic load events.

NCP6251 also supports V\_FIX mode for board debug and testing. In this particular configuration the SVI bus is used as a static bus configuring four operative voltages (through SVC and SVD) for both the sections and ignoring any serial-VID command.

NCP6251 is able to detect which kind of CPU is connected and configures itself to work as a Single-Plane PVI controller or Dual-Plane SVI controller.

### Remote Output Sensing Amplifier (RSA)

A true differential amplifier allows the NCP6251 to measure VCore voltage feedback with respect to the VCore ground reference point by connecting the VCore reference point to VSP, and the VCore ground reference point to VSN. This configuration keeps ground potential differences between the local controller ground and the VCore ground reference point from affecting regulation of VCore between VCore and VCore ground reference points. The RSA also subtracts the DAC (minus VID offset) voltage, thereby producing an unamplified output error voltage at the DIFFOUT pin. This output also has a 1.3 V bias voltage as the floating ground to allow both positive and negative error voltages.

### Precision Programmable DAC

A precision programmable DAC is provided and system trimmed. This DAC has 0.6% accuracy over the entire operating temperature range of the part. The NCP6251 is a Hybrid controller which supports both a six bit parallel VID interface (PVI) and a seven bit serial VID interface (SVI). The NCP6251 allows manufacturers to build a motherboard that will accommodate either parallel or serial VID processors in the same socket.

### High Performance Voltage Error Amplifier

The error amplifier is designed to provide high slew rate and bandwidth. Although not required when operating as the controller of a voltage regulator, a capacitor from COMP to VFB is required for stable unity gain test configurations.

### Gate Driver Outputs and 2/3/4 Phase Operation

The part can be configured to run in 2-, 3-, or 4-phase mode. In 2-phase mode, phases 1 and 3 should be used to drive the external gate drivers, G2 and G4 must be grounded. In 3-phase mode, gate output G4 must be grounded. In 4-phase mode all 4 gate outputs are used as shown in the 4-phase Applications Schematic. The Current Sense inputs of unused channels should be connected to GND or to VDD. Please refer to table "PIN CONNECTIONS vs. PHASE COUNTS" for details.

### Differential Current Sense Amplifiers and Summing Amplifier

Four differential amplifiers are provided to sense the output current of each phase. The inputs of each current sense amplifier must be connected across the current sensing element of the phase controlled by the corresponding gate output (G1, G2, G3, or G4). If a phase is unused, the differential inputs to that phase's current sense amplifier must be shorted together and connected to the GND or to VDD.

The current signals sensed from inductor DCR are fed into a summing amplifier to have a summed-up output. The outputs of current sense amplifiers control three functions. First, the summing current signal of all phases will go through DROOP amplifier and join the voltage feedback loop for output voltage positioning. Second, the output signal from DROOP amplifier also goes to ILIM amplifier to monitor the output current limit. Finally, the individual phase current contributes to the current balance of all phases by offsetting their ramp signals of PWM comparators.

### Oscillator and Triangle Wave Generator

The controller embeds a programmable precision dual-Oscillator: one section is used for the CORE and it is a multiphase programmable oscillator managing equal phase-shift among all phases and the other section is used for the NB section. The oscillator's frequency is programmed by the resistance connected from the ROSC pin to ground. The user will usually form this resistance from two resistors in order to create a voltage divider that uses the ROSC output voltage as the reference for creating the current limit setpoint voltage. The oscillator frequency range is 100 kHz per phase to 1.0 MHz per phase. The oscillator generates up to 4 symmetrical triangle waveforms with amplitude between 1.3 V and 2.3 V. The triangle waves have a phase delay between them such that for 2-, 3- and 4-phase operation the PWM outputs are separated by 180, 120, and 90 angular degrees, respectively.

When the NB phase is enabled, in order to ensure that the VDDNB oscillator does not accidentally lock to the VDD oscillator, the VDDNB oscillator will free-run at a frequency which is nominally 1.25 ratio of  $f_{VDD}$ .

# NCP6251

## CPU Support

NCP6251 is able to detect the CPU it is going to supply and configure itself to PVI or SVI mode. When in PVI mode, to address the CORE section the NCP6251 uses VID[5:0]. When in SVI mode NCP6251 uses VID2 and VID3 alone for SVC and SVD information respectively. Whether the controller is controlled by the serial or parallel interface is determined by sampling the VID1 line at the time that the voltage regulator enable line is asserted; if the VID1 line is high when Enable is asserted, the voltage regulator starts in PVI mode, otherwise the voltage regulator starts in SVI mode.

## PVI – Parallel Interface

PVI is a 6-bit wide parallel interface to address the CORE Section reference. NB is kept in HiZ mode. Parallel mode operation is depicted in Figure 9. Voltage identifications for the 6bit AMD mode is given in Table 2.

The normal PVI startup sequence for the NCP6251 is as follows:

- 5 V is applied to the VCCA and VCCB pins to power the NCP6251 and 12 V is applied to 12VMON.
- The NCP6251 samples the load on the G4 and G2 pins. If these pins are tied to ground the operating mode will be altered from four phase mode, to three phase, or two phase operation.
- The system power sequence logic asserts the NCP6251 ENABLE pin:

- The NCP6251 will sample the VID1 line to determine whether to start in SVI or PVI mode. PVID mode is determined when VID1 = High.
- The NCP6251 samples the voltage on the PSI\_L pin in order to determine the desired operating configuration during power saving mode.
- The Boot VID is captured from decoding the voltages on the VID[0:5].
- The NCP6251 V<sub>DD</sub> regulator will soft-start and ramp to the initial Boot VID. The VDDNB regulator remains off (high-Z output).
- PWRGOOD is asserted by the NCP6251.
- PWROK is not used in PVID mode.
- The NCP6251 will accept new VID codes on the parallel VID interface (See Table 2). See Figure 9 for details.

**Table 1. Metal VID/BOOT VID**

SVC	SVD	Output Voltage
		Pre-PWROK Metal VID
0	0	1.1 V
0	1	1.0 V
1	0	0.9 V
1	1	0.8 V

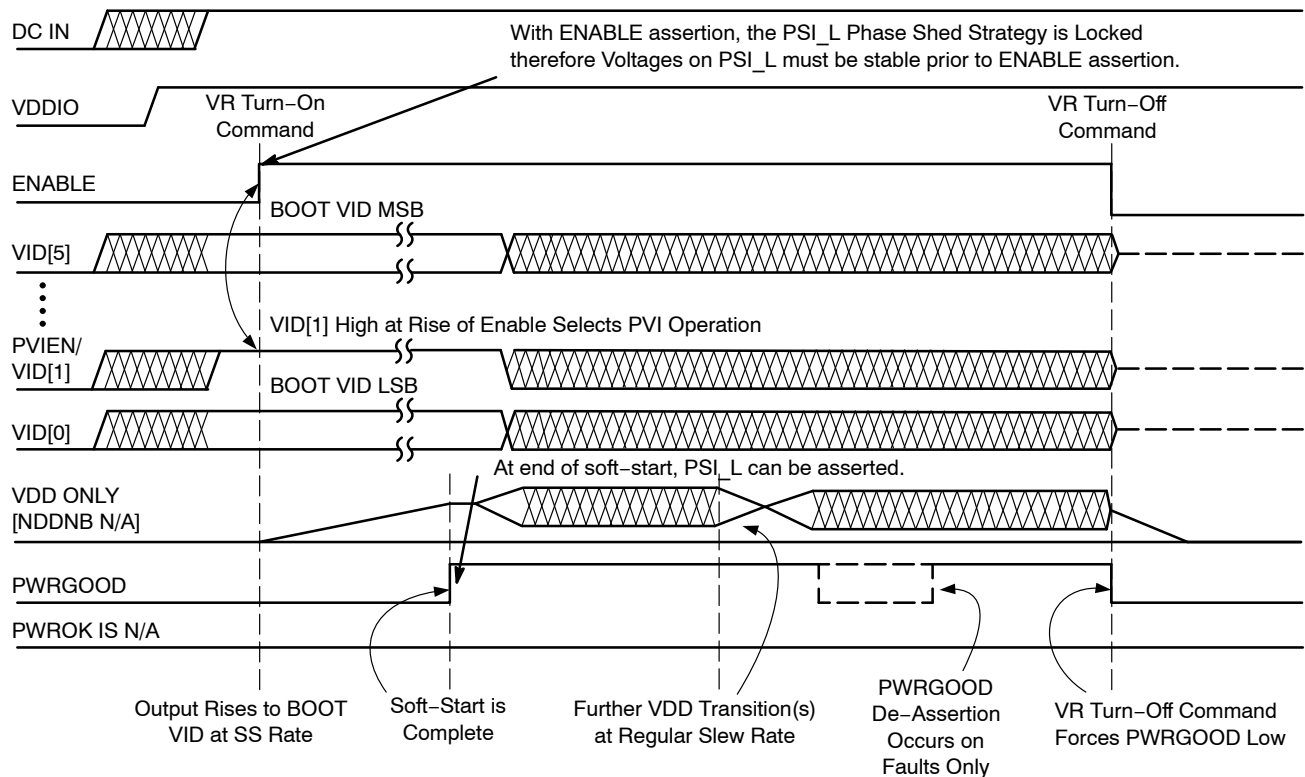

**Figure 9. Power Up Sequences in Parallel Mode Operation**

# NCP6251

**Table 2. SIX-BIT PARALLEL VID CODES in PVI Modes**

SVID[5:0]	V <sub>OUT</sub> (V)	SVID[5:0]	V <sub>OUT</sub> (V)	SVID[5:0]	V <sub>OUT</sub> (V)	SVID[5:0]	V <sub>OUT</sub> (V)
00_0000	1.5500	01_0000	1.1500	10_0000	0.7625	11_0000	0.5625
00_0001	1.5250	01_0001	1.1250	10_0001	0.7500	11_0001	0.5500
00_0010	1.5000	01_0010	1.1000	10_0010	0.7375	11_0010	0.5375
00_0011	1.4750	01_0011	1.0750	10_0011	0.7250	11_0011	0.5250
00_0100	1.4500	01_0100	1.0500	10_0100	0.7125	11_0100	0.5125
00_0101	1.4250	01_0101	1.0250	10_0101	0.7000	11_0101	0.5000
00_0110	1.4000	01_0110	1.0000	10_0110	0.6875	11_0110	0.4875
00_0111	1.3750	01_0111	0.9750	10_0111	0.6750	11_0111	0.4750
00_1000	1.3500	01_1000	0.9500	10_1000	0.6625	11_1000	0.4625
00_1001	1.3250	01_1001	0.9250	10_1001	0.6500	11_1001	0.4500
00_1010	1.3000	01_1010	0.9000	10_1010	0.6325	11_1010	0.4375
00_1011	1.2750	01_1011	0.8750	10_1011	0.6250	11_1011	0.4250
00_1100	1.2500	01_1100	0.8500	10_1100	0.6125	11_1100	0.4125
00_1101	1.2250	10_1101	0.8250	10_1101	0.6000	11_1101	0.4000
00_1110	1.2000	01_1110	0.8000	10_1110	0.5875	11_1110	0.3875
00_1111	1.1750	01_1111	0.7750	10_1111	0.5750	11_1111	0.3750

## SVI – Serial Interface

SVI is a two wire, Clock and Data, bus that connects a single master (CPU) to one NCP6251. The master initiates and terminates SVI transactions and drives the clock, SVC, and the data SVD, during a transaction. The slave receives the SVI transactions and acts accordingly. SVI wire protocol is based on fast-mode I2C.

PWROK is proprietary of the SVI protocol and is considered at start-up. The SVI mode operation is explained in Figure 10. The VID codes from the decoded SVI value are given in Table 3.

The normal SVI startup sequence for the NCP6251 is as follows:

- 5 V is applied to the VCCA and VCCB pins to power the NCP6251 and 12 V is applied to 12VMON.
- The NCP6251 samples the load on the G4 and G2 pins. If these pins are tied to ground the operating mode will be altered from four phase mode, to three phase, or two phase operation.
- The system power sequence logic asserts the NCP6251 ENABLE pin:

- The NCP6251 will sample the VID1 line to determine whether to start in SVI or PVI mode. SVID mode is determined when VID1 = Low.
- The NCP6251 samples the voltage on the PSI\_L pin in order to determine the desired operating configuration during power saving mode.
- The Boot VID is captured from decoding the voltages on the VID3/SVC and VID2/SVD pins per Table 1 and stored.
- The NCP6251 will start the VDD and VDDNB regulators. Both regulators will soft start and ramp to the Boot VID Voltage (See Table 1).
- The NCP6251 asserts PWROOD.
- The system asserts PWROK The system processor will hold the boot VID voltage for at least 10us after PWROK signal is asserted
- Now the NCP6251 can accept new SVID codes on the serial VID interface (See Table 3).
- If the system should de-assert PWROK, then the NCP6251 will reset the Core and Northbridge VIDs and regulate at the Boot VID voltage.

# NCP6251

**Table 3. SEVEN-BIT SERIAL VID CODES for SVI Mode**

SVID[6:0]	V <sub>OUT</sub> (V)	SVID[6:0]	V <sub>OUT</sub> (V)	SVID[6:0]	V <sub>OUT</sub> (V)	SVID[6:0]	V <sub>OUT</sub> (V)
000_0000	1.5500	010_0000	1.1500	100_0000	0.7500	110_0000	0.3500
000_0001	1.5375	010_0001	1.1375	100_0001	0.7375	110_0001	0.3375
000_0010	1.5250	010_0010	1.1250	100_0010	0.7250	110_0010	0.3250
000_0011	1.5125	010_0011	1.1125	100_0011	0.7125	110_0011	0.3125
000_0100	1.5000	010_0100	1.1000	100_0100	0.7000	110_0100	0.3000
000_0101	1.4875	010_0101	1.0875	100_0101	0.6875	110_0101	0.2875
000_0110	1.4750	010_0110	1.0750	100_0110	0.6750	110_0110	0.2750
000_0111	1.4625	010_0111	1.0625	100_0111	0.6625	110_0111	0.2625
000_1000	1.4500	010_1000	1.0500	100_1000	0.6500	110_1000	0.2500
000_1001	1.4375	010_1001	1.0375	100_1001	0.6325	110_1001	0.2375
000_1010	1.4250	010_1010	1.0250	100_1010	0.6250	110_1010	0.2250
000_1011	1.4125	010_1011	1.0125	100_1011	0.6125	110_1011	0.2125
000_1100	1.4000	010_1100	1.0000	100_1100	0.6000	110_1100	0.2000
000_1101	1.3875	010_1101	0.9875	100_1101	0.5875	110_1101	0.1875
000_1110	1.3750	010_1110	0.9750	100_1110	0.5750	110_1110	0.1750
000_1111	1.3625	010_1111	0.9625	100_1111	0.5625	110_1111	0.1625
001_0000	1.3500	011_0000	0.9500	101_0000	0.5500	111_0000	0.1500
001_0001	1.3375	011_0001	0.9375	101_0001	0.5375	111_0001	0.1375
001_0010	1.3250	011_0010	0.9250	101_0010	0.5250	111_0010	0.1250
001_0011	1.3125	011_0011	0.9125	101_0011	0.5125	111_0011	0.1125
001_0100	1.3000	011_0100	0.9000	101_0100	0.5000	111_0100	0.1000
001_0101	1.2875	011_0101	0.8875	101_0101	0.4875	111_0101	0.0875
001_0110	1.2750	011_0110	0.8750	101_0110	0.4750	111_0110	0.0750
001_0111	1.2625	011_0111	0.8625	101_0111	0.4625	111_0111	0.0625
001_1000	1.2500	011_1000	0.8500	101_1000	0.4500	111_1000	0.0500
001_1001	1.2375	011_1001	0.8375	101_1001	0.4375	111_1001	0.0375
001_1010	1.2250	011_1010	0.8250	101_1010	0.4250	111_1010	0.0250
001_1011	1.2125	011_1011	0.8125	101_1011	0.4125	111_1011	0.0125
001_1100	1.2000	011_1100	0.8000	101_1100	0.4000	111_1100	OFF
001_1101	1.1875	011_1101	0.7875	110_1101	0.3875	111_1101	OFF
001_1110	1.1750	011_1110	0.7750	101_1110	0.3750	111_1110	OFF
001_1111	1.1625	011_1111	0.7625	101_1111	0.3625	111_1111	OFF



# NCP6251

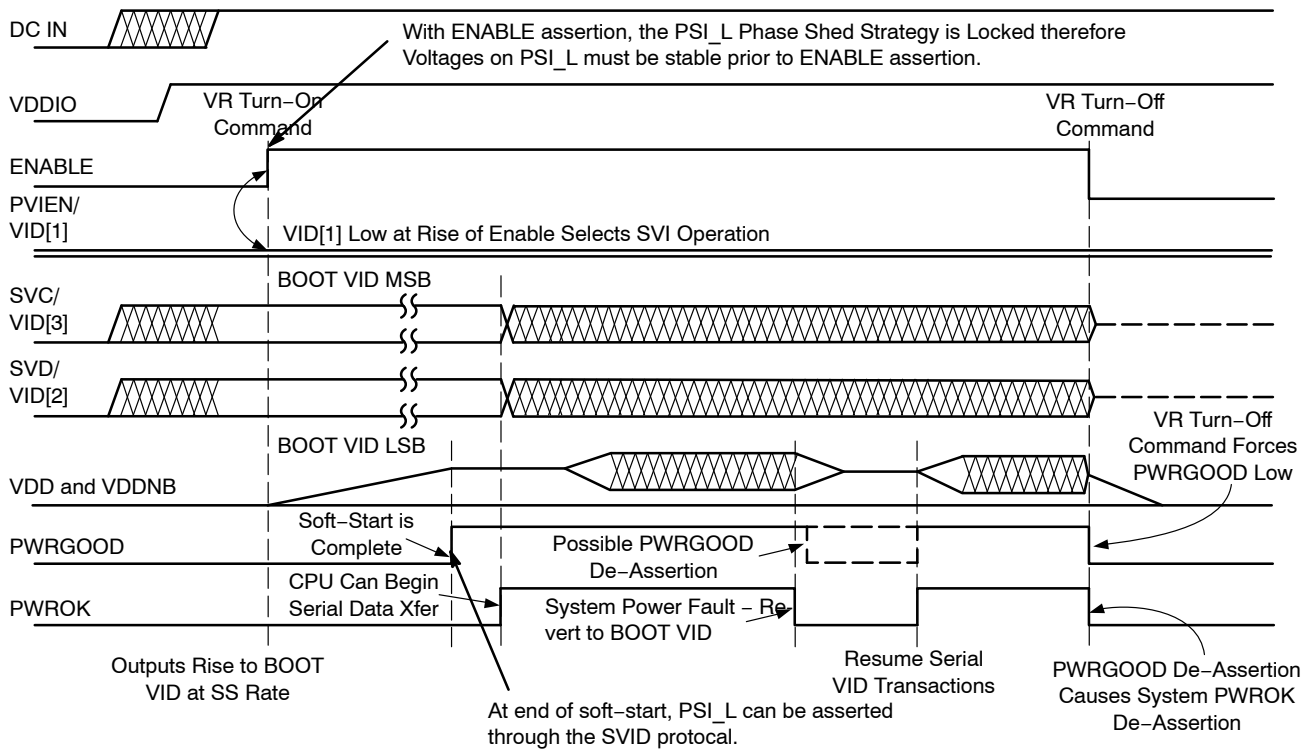

**Figure 10. Power-Up Sequence in Serial Mode Operation**

## Hardware Jumper Override – V\_FIX

VFIX is an active low pin and when it is pulled low, the controller enters V\_FIX mode. The voltage regulator can be powered when an external SVI bus master is not present. When in VFIX mode, all of the voltage regulator’s output voltages will be governed by the information shown in Table 4, regardless of the state of PWROK. VFIX mode is for debug only. If VFIX mode is necessary for processor bring-up, VFIXEN, SVC, and SVD should be connected with jumpers to either ground or VDDIO through suitable pull-up resistors. SVC and SVD are considered as static VID and the output voltage will change according to their status.

**Table 4. SVI VFIX VID CODES (TWO-BIT PARALLEL)**

SVC	SVD	V <sub>OUT</sub> (V)
0	0	1.4
0	1	1.2
1	0	1.0
1	1	0.8

The normal VFIXEN startup sequence for the NCP6251 is as follows:

- 5 V is applied to the VCCA and VCCB pins to power the NCP6251 and 12 V is applied to 12VMON.
- The NCP6251 samples the load on the G4 and G2 pins. If these pins are tied to ground the operating mode will be altered from four phase mode, to three phase, or two phase operation.

- The system power sequence logic asserts the NCP6251 ENABLE pin:
  - The NCP6251 will sample the VID1 line to determine whether to start in SVI or PVI mode.
  - The NCP6251 samples the voltage on the PSI\_L pin in order to determine the desired operating configuration during power saving mode.
  - The Boot VID is dependent on SVI or PVI mode startup.
- The NCP593A V<sub>DD</sub> regulator (and VDDNB if in SVID mode) will soft-start and ramp to the initial Boot VID.
- VFIXEN mode is entered once VFIXEN is asserted and the V<sub>DD</sub> and VDDNB regulators will regulate to the VFIXEN VID.
- VFIXEN VID is captured from decoding the voltages on the VID3/SVC and VID2/SVD pins per Table 4.
- If VFIXEN is asserted prior to the VID controller reaching the Boot VID, the VID controller will move to the VFIXEN VID.
- If VFIXEN is de-asserted, the device PORs. This occurs independent of ENABLE.

## PWROK De-Assertion

Anytime PWROK de-asserts while EN is asserted, the controller uses the previously stored *BOOT VID* and regulates all planes to that level performing an on-the-fly transition to that level. PWRGOOD remains asserted in this process.

## Power Saving Indicator (PSI\_L) and Phase Shedding

An AMD PVID processor provides an output signal to the NCP6251 controller's PSI\_L input to indicate when the processor is in a low power state. An AMD SVID processor indicates PSI\_L mode through the SVID protocol. The NCP6251 uses PSI\_L assertion to maximize efficiency at light loads. When PSI\_L is asserted, the PSI\_L function will be enabled, and the NCP6251 will run with a reduced phase count. The number of phases in PSI\_L mode is determined by the voltage level present on the PSI\_L input upon ENABLE assertion. This detection of phase count applies for both PVID and SVID AMD processors.

## Protection Features:

The NCP6251 handles many protection features. Undervoltage lockout, Over current shutdown, Overvoltage, Under voltage, Soft-Start etc are the main features. All the fault responses of the NCP6251 are listed in Table 5.

## Undervoltage Lockout

An undervoltage lockout (UVLO) senses the VCC and V<sub>CCP</sub> input. During powerup, the input voltage to the controller is monitored, and the PWM outputs and the soft-start circuit are disabled until the input voltage exceeds the threshold voltage of the UVLO comparator. The UVLO comparator incorporates hysteresis to avoid chattering, since VCC is likely to decrease as soon as the converter initiates soft-start.

## Overcurrent Shutdown

A programmable overcurrent function is incorporated within the IC. A comparator and latch make up this function. The inverting input of the comparator is connected to the I<sub>LIM</sub> pin. The voltage at this pin sets the maximum output current the converter can produce. The ROSC pin provides a convenient and accurate reference voltage from which a resistor divider can create the overcurrent setpoint voltage. Although not actually disabled, tying the I<sub>LIM</sub> pin directly to the ROSC pin sets the limit above useful levels – effectively disabling overcurrent shutdown. The comparator noninverting input is the summed current information from

the VDRP minus offset voltage. Internally there are two overcurrent thresholds based on the I<sub>LIM</sub> pin voltage. If the current information exceeds one of the thresholds, the overcurrent latch will be set either immediately (I<sub>LIM2</sub>) or with a delay of 50 ms (I<sub>LIM1</sub>). The outputs are pulled low, and the soft-start is pulled low. The outputs will remain disabled until the VCC voltage is removed and re-applied, or the ENABLE input is brought low and then high.

NB overcurrent is handled in similar way as the global CORE overcurrent. The total output current is compared with I<sub>limit</sub>/N<sub>phase</sub>. When overcurrent occurs in the NB, NB-DRVON is pulled low.

## Output Overvoltage and Undervoltage Protection and Power Good Monitor

An output voltage monitor is incorporated. During normal operation, if the output voltage is 250 mV over the DAC voltage, the PWRGOOD goes low, the DRVON signal remains high, the PWM outputs are set low. The outputs will remain disabled until the VCC voltage is removed and reapplied. Every time the OV is triggered it will increment the OV counter. If the counter reaches a count of 16 then the OV condition will latch into a permanent OV state. It will require POR or disable/enable to restart. Prior to latching if the OV condition goes away then normal operation will resume. An OV decrement counter is also incorporated. It consists of a free-running clock which runs at 8x the PWM frequency. So essentially every 4096 PWM cycles the OV counter will decrement. For example, for a max PWM frequency of 1 MHz, the counter decrements roughly every 4 ms and for a PWM frequency of 400 kHz, it would be about every 10 ms. During normal operation, if the output voltage falls more than 350 mV below the DAC setting, the PWRGOOD pin will be set low until the output voltage rises.

## Soft-Start

The NCP6251 ramps VDD (and VDDNB in SVID mode) to the Boot VID at a soft-start rate of 0.8 mV/μs typical. Upon receiving a PVID or SVID code (after PWROK assertion) the outputs ramp to the final DAC setting at the Dynamic VID slew rate of 3.25 mV/μs. Typical soft-start sequence timing is shown in Figure 11.

# NCP6251

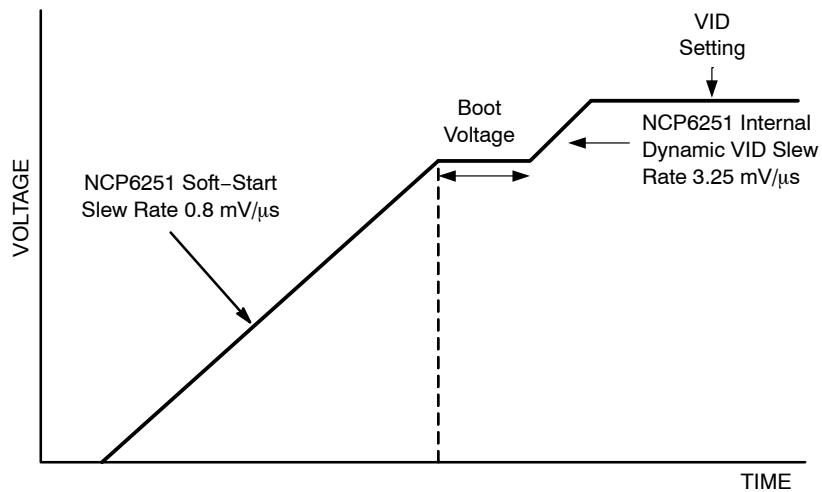

Figure 11. Soft Start Sequence to VCore

Table 5. FAULT RESPONSES

CONDITION	PWM OUTPUT(s)	PWRGOOD	DRVON (VDD)	DRVON (NB)	RESET METHOD	NOTES
VDD Global OCP ( $I_{LIM1}$ )	All to High-Z	Latched Low	Latched Low	Latched Low	Cycle ENABLE or +5 V and +12 V	Latched if the $V_{DD}$ rail current is over $I_{LIM1}$ (less than $I_{LIM2}$ ) for 50 ms
VDD Global OCP Immediately ( $I_{LIM2}$ )	All to High-Z	Latched Low	Latched Low	Latched Low	Cycle ENABLE or +5 V and +12 V	Latched immediately if the $V_{DD}$ rail current is over $I_{LIM2}$
NB OCP	All to High-Z	Latched Low	Latched Low	Latched Low	Cycle ENABLE or +5 V and +12 V	
Output OVP – Infrequent	Held Low for duration of OV	Held Low for duration of OV plus 500 $\mu$ s	Unaffected	Unaffected		“Infrequent” = fewer than 17 events per 4096/Fpwm seconds (e.g., 4.096 ms at Core PWM = 1 MHz)
Output OVP – Frequent	Latched Low	Latched Low	Unaffected	Unaffected	Cycle ENABLE, VCC (5 V) or 12 VMON	“Frequent” = 17 or more events per 4096/Fpwm seconds (e.g., 4.096 ms at Core PWM = 1 MHz)
Output UV Monitor	Unaffected	Held Low for duration of UV	Unaffected	Unaffected		
Unused Phase of VDD Regulator	Set to High-Z	Unaffected	Unaffected	Unaffected		
VDDNB Disabled	Set to High-Z	Unaffected by NB status	Unaffected	Latched Low		
5 V UVLO	All to High-Z	Held Low	Low until 5 V and 12 V are OK	Low until 5 V and 12 V are OK	Raise +5 V above UVLO Threshold	5 V and 12 V UVLO are the only modes which will force re-evaluating the phase count.
12 V UVLO	All to High-Z	Held Low	Low until 5 V and 12 V are OK	Low until 5 V and 12 V are OK	Raise +12 V above UVLO Threshold	5 V and 12 V UVLO are the only modes which will force re-evaluating the phase count.

# NCP6251

**Table 5. FAULT RESPONSES**

CONDITION	PWM OUT-PUT(s)	PWRGOOD	DRVON (VDD)	DRVON (NB)	RESET METHOD	NOTES
DRVON is Pulled Low by External Means	Unaffected (See Notes →)	Held Low	While Low a weak pull-up turns on	Unaffected	Address underlying cause, and let DRVON go High	VDD will try to regulate to 0 V. DRVON low will cause VDD MOSFETs to turn off. Both VDD & VDDNB will go through a SS upon recovery.
NB_DRVON is Pulled Low by External Means	Unaffected (See Notes →)	Held Low	Unaffected	While Low a weak pull-up turns on	Address underlying cause, and let NB_DRVON go High	VDDNB will try to regulate to 0 V. With NB_DRVON Low, all VDDNB MOSFETs to turnoff. Both VDD & VDDNB will go through a SS upon recovery.
ENABLE is Low	All to High-Z	Held Low	Held Low	Held Low	Assert ENABLE High	Cycling ENABLE does not cause the NCP6251 to re-evaluate the programmed number of phases

### Programming the Current Limit and the Oscillator Frequency

The demo board is set for an operating frequency of approximately 330 kHz. The ROSC pin provides a 2.0 V reference voltage which is divided down with a resistor divider and fed into the current limit pin ILIM. Calculate the total series resistance to set the frequency and then calculate the individual RLIM1 and RLIM2 values for the divider.

The series resistors RLIM1 and RLIM2 sink current from the ILIM pin to ground. This current is internally mirrored into a capacitor to create an oscillator. The period is

proportional to the resistance and frequency is inversely proportional to the total resistance. The total resistance may be estimated by Equation 2. This equation is valid for the individual phase frequency in both three and four phase mode.

$$R_{TOTAL} \cong 24686 \times F_{sw}^{-1.1549} \quad (\text{eq. 1})$$

$$30.5 \cdot \text{k}\Omega \cong 24686 \times 330^{-1.1549}$$

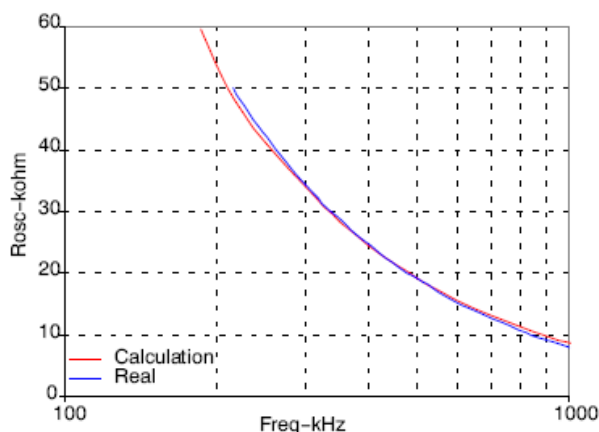

Figure 12. ROSC vs. Frequency

The current limit function is based on the total sensed current of all phases multiplied by a gain of 6. DCR sensed inductor current is function of the winding temperature. The best approach is to set the maximum current limit based on Calculate the current limit voltage:

the expected average maximum temperature of the inductor windings.

$$DCR_{Tmax} = DCR_{25C} \cdot (1 + 0.00393 (T_{max} - 25)) \quad (\text{eq. 2})$$

$$V_{LIMIT} \cong 6 \cdot \left( I_{MIN\_OCP} \cdot DCR_{Tmax} + \frac{DCR_{Tmax} \cdot V_{out}}{2 \cdot V_{in} \cdot F_{sw}} \cdot \left( \frac{V_{in} - V_{out}}{L} - (N-1) \cdot \frac{V_{out}}{L} \right) \right) \quad (\text{eq. 3})$$

Solve for the individual resistors:

$$RLIM2 = \frac{V_{LIMIT} \cdot R_{TOTAL}}{2 \cdot V} \quad (\text{eq. 4}) \quad \quad \quad RLIM1 = R_{TOTAL} - RLIM2 \quad (\text{eq. 5})$$

### Final Equation for the Current Limit Threshold

$$I_{LIMIT}(T_{inductor}) \cong \frac{\left( \frac{2 \cdot V \cdot RLIM2}{RLIM1 + RLIM2} \right)}{6 \cdot (DCR_{25C} \cdot (1 + 0.00393(T_{inductor} - 25)))} - \frac{V_{out}}{2 \cdot V_{in} \cdot F_{sw}} \cdot \left( \frac{V_{in} - V_{out}}{L} - (N-1) \cdot \frac{V_{out}}{L} \right) \quad (\text{eq. 6})$$

The inductors on the demo board have a DCR at 25°C of 0.75 mΩ. Selecting the closest available values of 16.9 kΩ for RLIM1 and 13.7 kΩ for RLIM2 yield a nominal operating frequency of 330 kHz and an approximate current limit of 152 A at 100°C. The total sensed current can be observed as a scaled voltage at the VDRP pin added to a positive, no-load offset of approximately 1.3 V.

### Two Stage Overcurrent Limit

NCP6251 will hold two overcurrent limits,  $I_{LIM1}$  is equal to  $I_{LIMIT}$ , it has a delayed latch response (50 ms).  $I_{LIM2}$  is typically 1.3 x  $I_{LIM1}$  and once triggered, PWM output will be immediately latched at high impedance.

# NCP6251

## OUTPUT OFFSET VOLTAGES

External offset voltages from 0 mV to 800 mV ‘above the DAC’ can be added for the  $V_{DD}$  and  $V_{DD\_NB}$  independently. Offset is set by a resistor divider from  $V_{CC}$  to GND. Output offsets are ratiometric to  $V_{CC}$ . As  $V_{CC}$  changes, the on-chip scaling factors change by the same amount:

$$\text{Offset} = 0.8 \text{ V} \times V_{\text{OFFSET}}/V_{CC}$$

For example: For 0 V offset: pin voltage = GND; For 800 mV offset: pin voltage =  $V_{CC}$

Minimum Voffset_IN (as $V_{in}/V_{CC}$ )	Typical Voffset_IN (as $V_{in}/V_{CC}$ )	Maximum Voffset_IN (as $V_{in}/V_{CC}$ )	Resulting Output Offset	Units
0	0	0.046875	0	mV
0.046875	0.06250	0.078125	25	mV
0.078125	0.09375	0.109375	50	mV
0.109375	0.12500	0.140625	75	mV
0.140625	0.15625	0.171875	100	mV
0.171875	0.18750	0.203125	125	mV
0.203125	0.21875	0.234375	150	mV
0.234375	0.25000	0.265625	175	mV
0.265625	0.28125	0.296875	200	mV
0.296875	0.31250	0.328125	225	mV
0.328125	0.34375	0.359375	250	mV
0.359375	0.37500	0.390625	275	mV
0.390625	0.40625	0.421875	300	mV
0.421875	0.43750	0.453125	325	mV
0.453125	0.46875	0.484375	350	mV
0.484375	0.50000	0.515625	375	mV
0.515625	0.53125	0.546875	400	mV
0.546875	0.56250	0.578125	425	mV
0.578125	0.59375	0.609375	450	mV
0.609375	0.62500	0.640625	475	mV
0.640625	0.65625	0.671875	500	mV
0.671875	0.68750	0.703125	525	mV
0.703125	0.71875	0.734375	550	mV
0.734375	0.75000	0.765625	575	mV
0.765625	0.78125	0.796875	600	mV
0.796875	0.81250	0.828125	625	mV
0.828125	0.84375	0.859375	650	mV
0.859375	0.87500	0.890625	675	mV
0.890625	0.90625	0.921875	700	mV
0.921875	0.93750	0.953125	725	mV
0.953125	0.96875	0.984375	750	mV
0.984375	1.00000	$V_{CC}+0.3 \text{ V}$	800	mV

The input to the OFFSET pin for the VDD output is encoded by an internal ADC.  
 The input to the NB\_OFFSET pin for the VDDNB output is encoded by the same ADC.  
 The reference for this ADC is  $V_{CC}$ . The ADC's output is ratiometric to  $V_{CC}$ .  
 Voffset IN represents the voltage applied to the OFFSET or NB\_OFFSET pin.  
 It is intended that these voltages be derived by a resistive divider from  $V_{CC}$ .  
 The recommended total driving impedance is <10 k $\Omega$ .

## NCP6251

In some modes, significant offset above VDAC could cause unpredictable results, or be harmful. The NCP6251 avoids such modes.

MODE	VDD OFFSET	NB OFFSET	NOTES
PVI (Soft-Start)	NO	N/A	Soft-Start is to Boot VID; NB is OFF
PVI (Normal Operation)	YES	N/A	Open it up for testing and gaming.
SVI (Soft-Start)	NO	NO	Soft-Start is to Boot VID; NB is ON
SVI (Boot VID)	NO	NO	Boot VID is AMD's start-up value
SVI (Normal Operation)	YES	YES	Open it up for testing and gaming.
VFIX	NO	NO	VFIX is a special test mode

# MECHANICAL CASE OUTLINE

## PACKAGE DIMENSIONS

ON Semiconductor®



QFN48 7x7, 0.5P  
CASE 485AJ-01  
ISSUE O

DATE 27 APR 2007

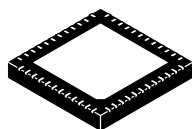

1 48

SCALE 2:1

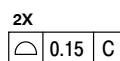
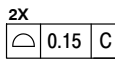
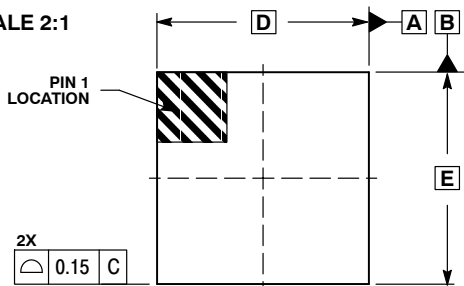

TOP VIEW

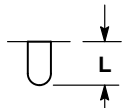

DETAIL A  
OPTIONAL CONSTRUCTION  
2X SCALE

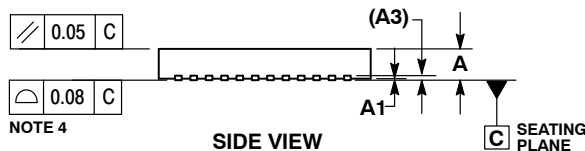

NOTE 4

SIDE VIEW

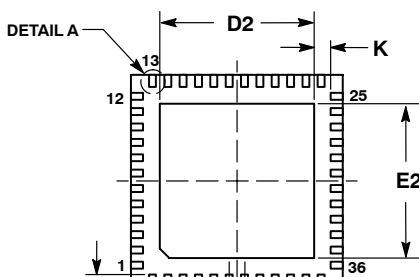

BOTTOM VIEW

$\text{M}$	0.10	C	A	B
$\text{N}$	0.05	C		

NOTE 3

NOTES:

- DIMENSIONS AND TOLERANCING PER ASME Y14.5M, 1994.
- CONTROLLING DIMENSION: MILLIMETERS.
- DIMENSION b APPLIES TO THE PLATED TERMINAL AND IS MEASURED BETWEEN 0.15 AND 0.30 MM FROM TERMINAL TIP.
- COPLANARITY APPLIES TO THE EXPOSED PAD AS WELL AS THE TERMINALS.

MILLIMETERS		
DIM	MIN	MAX
A	0.80	1.00
A1	0.00	0.05
A3	0.20 REF	
b	0.20	0.30
D	7.00 BSC	
D2	5.00	5.20
E	7.00 BSC	
E2	5.00	5.20
e	0.50 BSC	
K	0.20	---
L	0.30	0.50

GENERIC MARKING DIAGRAM\*

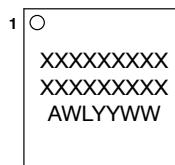

- A = Assembly Location
- WL = Wafer Lot
- YY = Year
- WW = Work Week

\*This information is generic. Please refer to device data sheet for actual part marking.  
Pb-Free indicator, "G" or microdot "•", may or may not be present.

SOLDERING FOOTPRINT\*

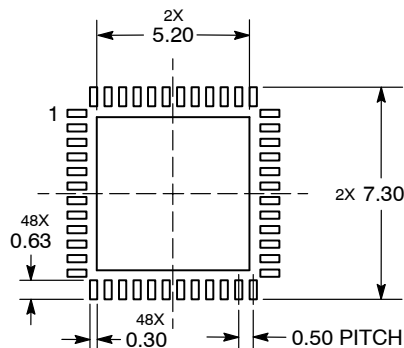

DIMENSIONS: MILLIMETERS

\*For additional information on our Pb-Free strategy and soldering details, please download the ON Semiconductor Soldering and Mounting Techniques Reference Manual, SOLDERRM/D.

DOCUMENT NUMBER:	98AON24490D	Electronic versions are uncontrolled except when accessed directly from the Document Repository. Printed versions are uncontrolled except when stamped "CONTROLLED COPY" in red.
DESCRIPTION:	QFN48 7X7, 0.50P	PAGE 1 OF 1

ON Semiconductor and are trademarks of Semiconductor Components Industries, LLC dba ON Semiconductor or its subsidiaries in the United States and/or other countries. ON Semiconductor reserves the right to make changes without further notice to any products herein. ON Semiconductor makes no warranty, representation or guarantee regarding the suitability of its products for any particular purpose, nor does ON Semiconductor assume any liability arising out of the application or use of any product or circuit, and specifically disclaims any and all liability, including without limitation special, consequential or incidental damages. ON Semiconductor does not convey any license under its patent rights nor the rights of others.



**onsemi**, **Onsemi**, and other names, marks, and brands are registered and/or common law trademarks of Semiconductor Components Industries, LLC dba "**onsemi**" or its affiliates and/or subsidiaries in the United States and/or other countries. **onsemi** owns the rights to a number of patents, trademarks, copyrights, trade secrets, and other intellectual property. A listing of **onsemi**'s product/patent coverage may be accessed at [www.onsemi.com/site/pdf/Patent-Marking.pdf](http://www.onsemi.com/site/pdf/Patent-Marking.pdf). **onsemi** reserves the right to make changes at any time to any products or information herein, without notice. The information herein is provided "as-is" and **onsemi** makes no warranty, representation or guarantee regarding the accuracy of the information, product features, availability, functionality, or suitability of its products for any particular purpose, nor does **onsemi** assume any liability arising out of the application or use of any product or circuit, and specifically disclaims any and all liability, including without limitation special, consequential or incidental damages. Buyer is responsible for its products and applications using **onsemi** products, including compliance with all laws, regulations and safety requirements or standards, regardless of any support or applications information provided by **onsemi**. "Typical" parameters which may be provided in **onsemi** data sheets and/or specifications can and do vary in different applications and actual performance may vary over time. All operating parameters, including "Typicals" must be validated for each customer application by customer's technical experts. **onsemi** does not convey any license under any of its intellectual property rights nor the rights of others. **onsemi** products are not designed, intended, or authorized for use as a critical component in life support systems or any FDA Class 3 medical devices or medical devices with a same or similar classification in a foreign jurisdiction or any devices intended for implantation in the human body. Should Buyer purchase or use **onsemi** products for any such unintended or unauthorized application, Buyer shall indemnify and hold **onsemi** and its officers, employees, subsidiaries, affiliates, and distributors harmless against all claims, costs, damages, and expenses, and reasonable attorney fees arising out of, directly or indirectly, any claim of personal injury or death associated with such unintended or unauthorized use, even if such claim alleges that **onsemi** was negligent regarding the design or manufacture of the part. **onsemi** is an Equal Opportunity/Affirmative Action Employer. This literature is subject to all applicable copyright laws and is not for resale in any manner.

## ADDITIONAL INFORMATION

### TECHNICAL PUBLICATIONS:

Technical Library: [www.onsemi.com/design/resources/technical-documentation](http://www.onsemi.com/design/resources/technical-documentation)  
onsemi Website: [www.onsemi.com](http://www.onsemi.com)

### ONLINE SUPPORT: [www.onsemi.com/support](http://www.onsemi.com/support)

For additional information, please contact your local Sales Representative at [www.onsemi.com/support/sales](http://www.onsemi.com/support/sales)