

# NCP502, NCV502

## Voltage Regulator - CMOS Low Iq, Low-Dropout

80 mA

The NCP502 series of fixed output linear regulators are designed for handheld communication equipment and portable battery powered applications which require low quiescent. The NCP502 series features an ultra-low quiescent current of 40  $\mu$ A. Each device contains a voltage reference unit, an error amplifier, a PMOS power transistor, resistors for setting output voltage, current limit, and temperature limit protection circuits.

The NCP502 has been designed to be used with low cost ceramic capacitors. The device is housed in the micro-miniature SC70-5 and TSOP-5 surface mount packages. Standard voltage versions are 1.5 V, 1.8 V, 2.5 V, 2.7 V, 2.8 V, 2.9 V, 3.0 V, 3.1 V, 3.3 V, 3.4 V, 3.5 V, 3.6 V, 3.7 V and 5.0 V. Other voltages are available in 100 mV steps.

### Features

- Low Quiescent Current of 40  $\mu$ A Typical
- Excellent Line and Load Regulation
- Low Output Voltage Option
- Output Voltage Accuracy of 2.0%
- Industrial Temperature Range of  $-40^{\circ}\text{C}$  to  $85^{\circ}\text{C}$ ,  
NCV502,  $T_A = -40^{\circ}\text{C}$  to  $125^{\circ}\text{C}$
- NCP502: 1.3 V Enable Threshold High, 0.3 V Enable Threshold Low
- NCV Prefix for Automotive and Other Applications Requiring Unique Site and Control Change Requirements; AEC-Q100 Qualified and PPAP Capable
- These are Pb-Free Devices

### Typical Applications

- Cellular Phones
- Battery Powered Consumer Products
- Hand-Held Instruments
- Camcorders and Cameras

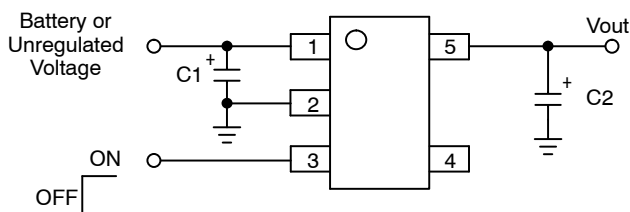

This device contains 86 active transistors

Figure 1. Typical Application Diagram



ON Semiconductor®

[www.onsemi.com](http://www.onsemi.com)

### MARKING DIAGRAM



SC70-5  
SQ SUFFIX  
CASE 419A

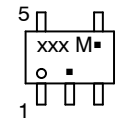

TSOP-5  
(SOT23-5, SC59-5)  
SN SUFFIX  
CASE 483

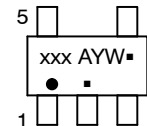

xxx = Specific Device Code  
A = Assembly Location  
Y = Year  
W = Work Week  
M = Date Code  
▪ = Pb-Free Package

(Note: Microdot may be in either location)

### PIN CONNECTIONS

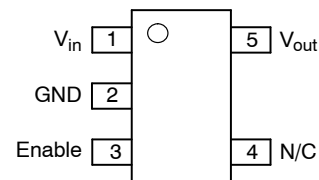

(Top View)

### ORDERING INFORMATION

See detailed ordering and shipping information in the package dimensions section on page 7 of this data sheet.

# NCP502, NCV502

## PIN FUNCTION DESCRIPTION

| Pin No. | Pin Name  | Description  |
|---------|-----------|--|
| 1       | $V_{in}$  | Positive power supply input voltage.   |
| 2       | GND       | Power supply ground.   |
| 3       | Enable    | This input is used to place the device into low-power standby. When this input is pulled low, the device is disabled. If this function is not used, Enable should be connected to $V_{in}$ . |
| 4       | N/C       | No internal connection.  |
| 5       | $V_{out}$ | Regulated output voltage.  |

## MAXIMUM RATINGS

| Rating   | Symbol    | Value   | Unit |
|--|-----------|---|------|
| Input Voltage  | $V_{in}$  | 12  | V    |
| Enable Voltage   | Enable    | -0.3 to $V_{in} + 0.3$                        | V    |
| Output Voltage   | $V_{out}$ | -0.3 to $V_{in} + 0.3$                        | V    |
| Power Dissipation and Thermal Characteristics<br>Power Dissipation | $P_D$     | Internally Limited                            | W    |
| Operating Junction Temperature                                     | $T_J$     | +150  | °C   |
| Operating Ambient Temperature                                      | $T_A$     | NCP502<br>-40 to +85<br>NCV502<br>-40 to +125 | °C   |
| Storage Temperature  | $T_{stg}$ | -55 to +150                                   | °C   |

Stresses exceeding those listed in the Maximum Ratings table may damage the device. If any of these limits are exceeded, device functionality should not be assumed, damage may occur and reliability may be affected.

1. Latchup capability (85°C)  $\pm 100$  mA DC with trigger voltage.

## THERMAL CHARACTERISTICS

| Rating   | Symbol          | Test Conditions                            | Value | Unit      |
|--|-----------------|--|-------|-----------|
| Thermal Characteristics, TSOP-5 (Note 2)<br>Thermal Resistance, Junction-to-Air (Note 3) | $R_{\theta JA}$ | 1 oz Copper Thickness, 100 mm <sup>2</sup> | 205   | °C/W      |
| Thermal Resistance, Junction-to-Ambient, SC70-5  | $R_{\theta JA}$ |  | 400   | W<br>°C/W |

NOTE: Single component mounted on a 80 x 80 x 15 mm FR4 PCB with stated copper head spreading area. Using the following boundary conditions as stated in EIA/JESD 51-1, 2, 3, 7, 12.

2. True no connect. Printed circuit board traces are allowable.
3. This device series contains ESD protection and exceeds the following tests:  
Human Body Model 2000 V per MIL-STD-883, Method 3015.  
Machine Model Method 200 V..

# NCP502, NCV502

## ELECTRICAL CHARACTERISTICS

( $V_{in} = V_{out(nom.)} + 2.0\text{ V}$ ,  $V_{enable} = V_{in}$ ,  $C_{in} = 1.0\ \mu\text{F}$ ,  $C_{out} = 1.0\ \mu\text{F}$ ,  $T_J = 25^\circ\text{C}$ , unless otherwise noted.)

| Characteristic   | Symbol             | Min   | Typ  | Max  | Unit                  |
|--|--------------------|---|--|--|-----------------------|
| Output Voltage ( $T_A = 25^\circ\text{C}$ , $I_{out} = 10\text{ mA}$ ) $V_{in} = V_{out(nom.)} + 1.0\text{ V}$<br>1.5 V<br>1.8 V<br>2.5 V<br>2.7 V<br>2.8 V<br>2.9 V<br>3.0 V<br>3.1 V<br>3.3 V<br>3.4 V<br>3.5 V<br>3.6 V<br>3.7 V<br>5.0 V | $V_{out}$          | 1.455<br>1.746<br>2.425<br>2.646<br>2.744<br>2.842<br>2.94<br>3.038<br>3.234<br>3.332<br>3.43<br>3.528<br>3.626<br>4.900  | 1.5<br>1.8<br>2.5<br>2.7<br>2.8<br>2.9<br>3.0<br>3.1<br>3.3<br>3.4<br>3.5<br>3.6<br>3.7<br>5.0 | 1.545<br>1.854<br>2.575<br>2.754<br>2.856<br>2.958<br>3.06<br>3.162<br>3.366<br>3.468<br>3.57<br>3.672<br>3.774<br>5.100 | V                     |
| Output Voltage ( $T_A = T_{low}$ to $T_{high}$ , $I_{out} = 10\text{ mA}$ ) $V_{in} = V_{out(nom.)}$<br>1.5 V<br>1.8 V<br>2.5 V<br>2.7 V<br>2.8 V<br>2.9 V<br>3.0 V<br>3.1 V<br>3.3 V<br>3.4 V<br>3.5 V<br>3.6 V<br>3.7 V<br>5.0 V           | $V_{out}$          | 1.455<br>1.746<br>2.425<br>2.619<br>2.716<br>2.813<br>2.910<br>3.007<br>3.201<br>3.298<br>3.43<br>3.528<br>3.626<br>4.900 | 1.5<br>1.8<br>2.5<br>2.7<br>2.8<br>2.9<br>3.0<br>3.1<br>3.3<br>3.4<br>3.5<br>3.6<br>3.7<br>5.0 | 1.545<br>1.854<br>2.575<br>2.781<br>2.884<br>2.987<br>3.09<br>3.193<br>3.399<br>3.502<br>3.57<br>3.672<br>3.774<br>5.100 | V                     |
| Line Regulation ( $V_{in} = V_{out} + 1.0\text{ V}$ to $12\text{ V}$ , $I_{out} = 10\text{ mA}$ )  | $Reg_{line}$       | –   | 0.4  | 3.0  | mV/V                  |
| Load Regulation ( $I_{out} = 1.0\text{ mA}$ to $80\text{ mA}$ )  | $Reg_{load}$       | –   | 0.2  | 0.8  | mV/mA                 |
| Output Current ( $V_{out} = (V_{out} \text{ at } I_{out} = 80\text{ mA}) - 3\%$ )  | $I_{o(nom.)}$      | 80  | 180  | –  | mA                    |
| Dropout Voltage ( $T_A = T_{low}$ to $T_{high}$ , $I_{out} = 80\text{ mA}$ , Measured at $V_{out} - 3.0\%$ )<br>1.5 V–1.7 V<br>1.8 V–2.4 V<br>2.5 V–2.6 V<br>2.7 V–2.9 V<br>3.0 V–4.0 V<br>4.1 V–5.0 V<br>NCV502 – 5.0 V                     | $V_{in} - V_{out}$ | –<br>–<br>–<br>–<br>–<br>–<br>–   | 1500<br>1300<br>1000<br>850<br>850<br>600<br>700   | 1900<br>1700<br>1400<br>1300<br>1200<br>900<br>1100  | mV                    |
| Quiescent Current<br>(Enable Input = 0 V)<br>(Enable Input = $V_{in}$ , $I_{out} = 1.0\text{ mA}$ to $I_{o(nom.)}$ )   | $I_Q$              | –<br>–  | 0.1<br>40  | 1.0<br>90  | $\mu\text{A}$         |
| Output Short Circuit Current ( $V_{out} = 0\text{ V}$ )  | $I_{out(max)}$     | 90  | 200  | 500  | mA                    |
| Ripple Rejection ( $f = 1.0\text{ kHz}$ , $15\text{ mA}$ )   | RR                 | –   | 55   | –  | dB                    |
| Output Voltage Noise ( $f = 100\text{ Hz}$ to $100\text{ kHz}$ )   | $V_n$              | –   | 180  | –  | $\mu\text{Vrms}$      |
| Enable Input Threshold Voltage (NCP502)<br>(Voltage Increasing, Output Turns On, Logic High)<br>(Voltage Decreasing, Output Turns Off, Logic Low)  | $V_{th(en)}$       | 1.3<br>–  | –<br>–   | –<br>0.3   | V                     |
| Output Voltage Temperature Coefficient   | $T_C$              | –   | 100  | –  | ppm/ $^\circ\text{C}$ |

4. Maximum package power dissipation limits must be observed.

$$P_D = \frac{T_J(max) - T_A}{R_{\theta JA}}$$

5. Low duty cycle pulse techniques are used during testing to maintain the junction temperature as close to ambient as possible.

# NCP502, NCV502

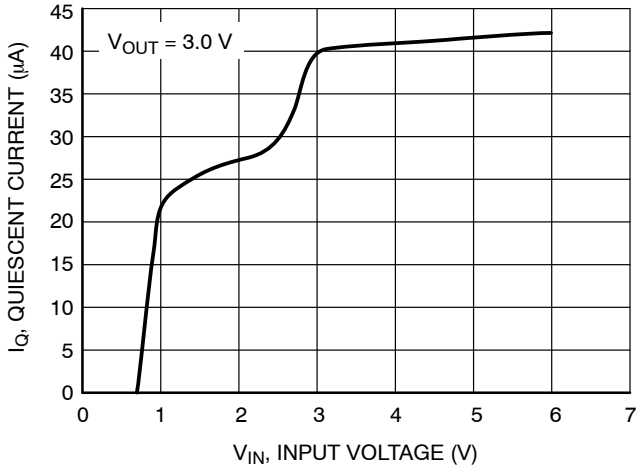

Figure 2. Quiescent Current versus Input Voltage



Figure 3. Quiescent Current versus Temperature

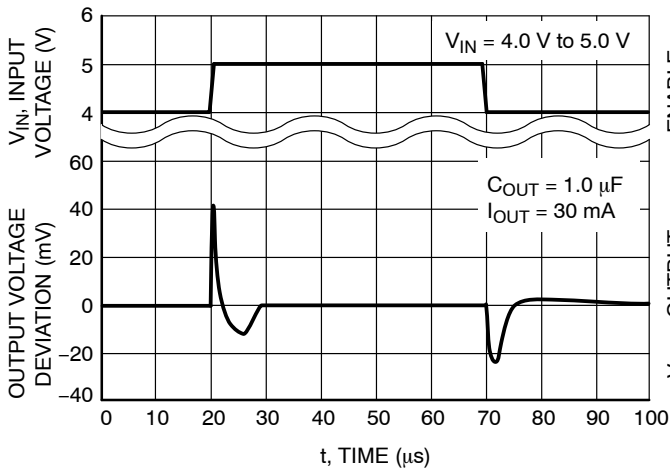

Figure 4. Line Transient Response

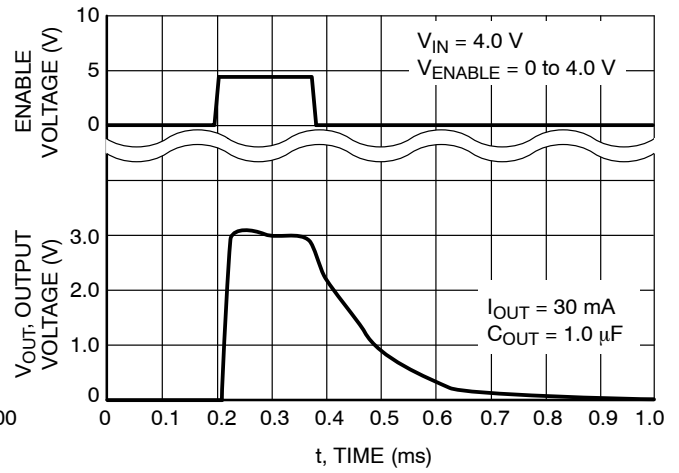

Figure 5. Enable Response

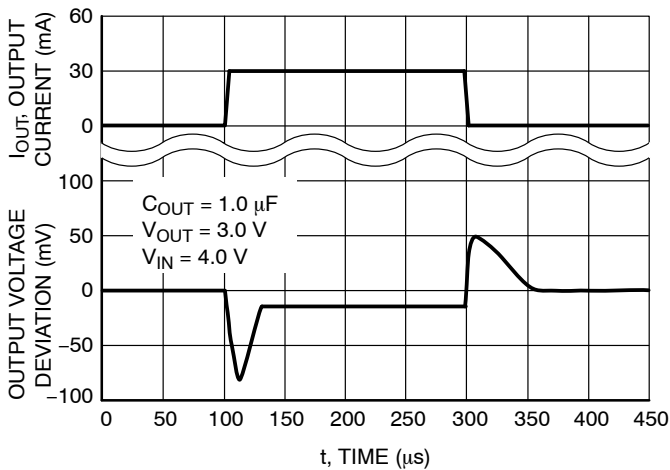

Figure 6. Load Transient Response

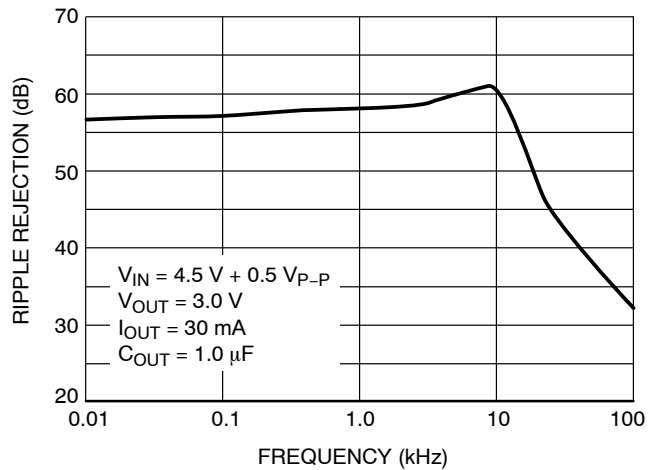
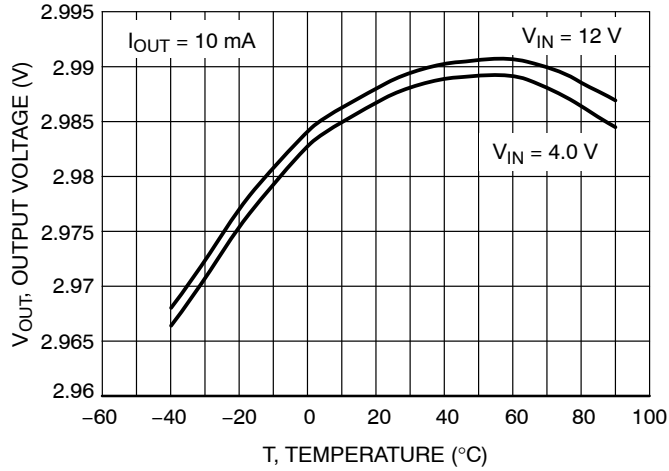
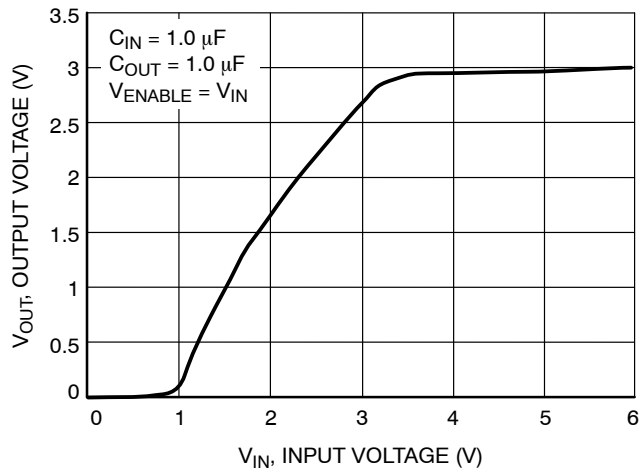

Figure 7. Ripple Rejection/Frequency

# NCP502, NCV502



**Figure 8. Output Voltage versus Temperature**



**Figure 9. Output Voltage versus Input Voltage**

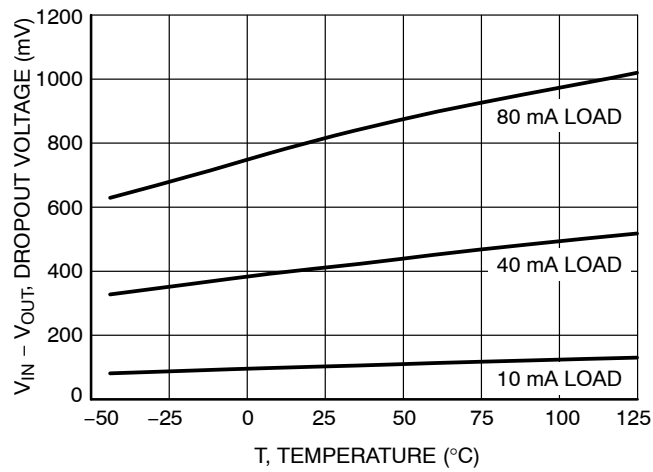

**Figure 10. Dropout Voltage versus Temperature**

## DEFINITIONS

### Load Regulation

The change in output voltage for a change in output current at a constant temperature.

### Dropout Voltage

The input/output differential at which the regulator output no longer maintains regulation against further reductions in input voltage. Measured when the output drops 3.0% below its nominal. The junction temperature, load current, and minimum input supply requirements affect the dropout level.

### Maximum Power Dissipation

The maximum total dissipation for which the regulator will operate within its specifications.

### Quiescent Current

The quiescent current is the current which flows through the ground when the LDO operates without a load on its output: internal IC operation, bias, etc. When the LDO becomes loaded, this term is called the Ground current. It is actually the difference between the input current (measured through the LDO input pin) and the output current.

### Line Regulation

The change in output voltage for a change in input voltage. The measurement is made under conditions of low dissipation or by using pulse technique such that the average chip temperature is not significantly affected.

### Line Transient Response

Typical over and undershoot response when input voltage is excited with a given slope.

### Thermal Protection

Internal thermal shutdown circuitry is provided to protect the integrated circuit in the event that the maximum junction temperature is exceeded. When activated at typically 160°C, the regulator turns off. This feature is provided to prevent failures from accidental overheating.

### Maximum Package Power Dissipation

The maximum power package dissipation is the power dissipation level at which the junction temperature reaches its maximum operating value, i.e. 125°C. Depending on the ambient power dissipation and thus the maximum available output current.

## APPLICATIONS INFORMATION

A typical application circuit for the NCP502 series is shown in Figure 1, front page.

### Input Decoupling (C1)

A 1.0  $\mu$ F capacitor either ceramic or tantalum is recommended and should be connected close to the NCP502 package. Higher values and lower ESR will improve the overall line transient response. If large line or load transients are not expected, then it is possible to operate the regulator without the use of a capacitor.

TDK capacitor: C2012X5R1C105K, or C1608X5R1A105K

### Output Decoupling (C2)

The NCP502 is a stable regulator and does not require any specific Equivalent Series Resistance (ESR) or a minimum output current. Capacitors exhibiting ESRs ranging from a few m $\Omega$  up to 5.0  $\Omega$  can thus safely be used. The minimum decoupling value is 1.0  $\mu$ F and can be augmented to fulfill stringent load transient requirements. The regulator accepts ceramic chip capacitors as well as tantalum devices. Larger values improve noise rejection and load regulation transient response.

TDK capacitor: C2012X5R1C105K, C1608X5R1A105K, or C3216X7R1C105K

### Enable Operation

The enable pin will turn on the regulator when pulled high and turn off the regulator when pulled low. These limits of

threshold are covered in the electrical specification section of this data sheet. If the enable is not used then the pin should be connected to  $V_{in}$ .

### Hints

Please be sure the  $V_{in}$  and GND lines are sufficiently wide. When the impedance of these lines is high, there is a chance to pick up noise or cause the regulator to malfunction.

Set external components, especially the output capacitor, as close as possible to the circuit, and make leads as short as possible.

### Thermal

As power across the NCP502 increases, it might become necessary to provide some thermal relief. The maximum power dissipation supported by the device is dependent upon board design and layout. Mounting pad configuration on the PCB, the board material and also the ambient temperature effect the rate of temperature rise for the part. This is stating that when the NCP502 has good thermal conductivity through the PCB, the junction temperature will be relatively low with high power dissipation applications.

## NCP502, NCV502

The maximum dissipation the package can handle is given by:

$$PD = \frac{T_J(\max) - T_A}{R_{\theta JA}}$$

If junction temperature is not allowed above the maximum 125°C, then the NCP502 can dissipate up to 250 mW @ 25°C.

The power dissipated by the NCP502 can be calculated from the following equation:

$$P_{tot} = [V_{in} * I_{gnd} (I_{out})] + [V_{in} - V_{out}] * I_{out}$$

or

$$V_{inMAX} = \frac{P_{tot} + V_{out} * I_{out}}{I_{gnd} + I_{out}}$$

If an 80 mA output current is needed then the ground current from the data sheet is 40 µA. For an NCP502 (3.0 V), the maximum input voltage will then be 6.12 V.

### ORDERING INFORMATION

| Device         | Nominal Output Voltage | Marking | Package             | Shipping†          |
|----------------|------------------------|---------|---------------------|--------------------|
| NCP502SQ15T2G  | 1.5                    | LCC     | SC70-5<br>(Pb-Free) | 3000 / Tape & Reel |
| NCP502SQ18T2G  | 1.8                    | LCD     |                     |                    |
| NCP502SQ25T2G  | 2.5                    | LCE     |                     |                    |
| NCP502SQ27T2G  | 2.7                    | LCF     |                     |                    |
| NCP502SQ28T2G  | 2.8                    | LCG     |                     |                    |
| NCP502SQ29T2G  | 2.9                    | LJI     |                     |                    |
| NCP502SQ30T2G  | 3.0                    | LCH     |                     |                    |
| NCP502SQ31T2G  | 3.1                    | LJJ     |                     |                    |
| NCP502SQ33T2G  | 3.3                    | LCI     |                     |                    |
| NCP502SQ34T2G  | 3.4                    | LJK     |                     |                    |
| NCP502SQ35T2G  | 3.5                    | LGO     |                     |                    |
| NCP502SQ36T2G  | 3.6                    | LIU     |                     |                    |
| NCP502SQ37T2G  | 3.7                    | LJQ     |                     |                    |
| NCP502SQ50T2G  | 5.0                    | LCJ     |                     |                    |
| NCP502SN28T1G  | 2.8                    | LKD     | TSOP-5<br>(Pb-Free) | 3000 / Tape & Reel |
| NCP502SN29T1G  | 2.9                    | LJN     |                     |                    |
| NCP502SN30T1G  | 3.0                    | LKE     |                     |                    |
| NCP502SN31T1G  | 3.1                    | LJO     |                     |                    |
| NCP502SN33T1G  | 3.3                    | LKF     |                     |                    |
| NCV502SN33T1G* | 3.3                    | LKF     |                     |                    |
| NCP502SN34T1G  | 3.4                    | LJK     |                     |                    |
| NCP502SN35T1G  | 3.5                    | LJ6     |                     |                    |
| NCP502SN36T1G  | 3.6                    | AC4     |                     |                    |
| NCP502SN37T1G  | 3.7                    | LKC     |                     |                    |
| NCP502SN50T1G  | 5.0                    | LKG     |                     |                    |
| NCV502SN50T1G* | 5.0                    | LKG     |                     |                    |

Additional voltages in 100 mV steps are available upon request by contacting your ON Semiconductor representative.

†For information on tape and reel specifications, including part orientation and tape sizes, please refer to our Tape and Reel Packaging Specifications Brochure, BRD8011/D.

\*NCV Prefix for Automotive and Other Applications Requiring Unique Site and Control Change Requirements; AEC-Q100 Qualified and PPAP Capable.

# MECHANICAL CASE OUTLINE PACKAGE DIMENSIONS



SCALE 2:1

## SC-88A (SC-70-5/SOT-353) CASE 419A-02 ISSUE M

DATE 11 APR 2023



### RECOMMENDED MOUNTING FOOTPRINT

\* For additional information on our Pb-Free strategy and soldering details, please download the ON Semiconductor Soldering and Mounting Techniques Reference Manual, SOLDERM/D.

### NOTES:

1. DIMENSIONING AND TOLERANCING PER ANSI Y14.5M, 1982.
2. CONTROLLING DIMENSION: MILLIMETERS
3. 419A-01 OBSOLETE. NEW STANDARD 419A-02
4. DIMENSIONS D AND E1 DO NOT INCLUDE MOLD FLASH, PROTRUSIONS, OR GATE BURRS. MOLD FLASH, PROTRUSIONS, OR GATE BURRS SHALL NOT EXCEED 0.1016MM PER SIDE.

| DIM | MILLIMETERS |      |      |
|-----|-------------|------|------|
|     | MIN.        | NOM. | MAX. |
| A   | 0.80        | 0.95 | 1.10 |
| A1  | ---         | ---  | 0.10 |
| A3  | 0.20 REF    |      |      |
| b   | 0.10        | 0.20 | 0.30 |
| c   | 0.10        | ---  | 0.25 |
| D   | 1.80        | 2.00 | 2.20 |
| E   | 2.00        | 2.10 | 2.20 |
| E1  | 1.15        | 1.25 | 1.35 |
| e   | 0.65 BSC    |      |      |
| L   | 0.10        | 0.15 | 0.30 |

### GENERIC MARKING DIAGRAM\*



\*This information is generic. Please refer to device data sheet for actual part marking. Pb-Free indicator, "G" or microdot "▪", may or may not be present. Some products may not follow the Generic Marking.

XXX = Specific Device Code

M = Date Code

▪ = Pb-Free Package

(Note: Microdot may be in either location)

#### STYLE 1:

1. BASE
2. EMITTER
3. BASE
4. COLLECTOR
5. COLLECTOR

#### STYLE 2:

1. ANODE
2. EMITTER
3. BASE
4. COLLECTOR
5. CATHODE

#### STYLE 3:

1. ANODE 1
2. N/C
3. ANODE 2
4. CATHODE 2
5. CATHODE 1

#### STYLE 4:

1. SOURCE 1
2. DRAIN 1/2
3. SOURCE 1
4. GATE 1
5. GATE 2

#### STYLE 5:

1. CATHODE
2. COMMON ANODE
3. CATHODE 2
4. CATHODE 3
5. CATHODE 4

#### STYLE 6:

1. EMITTER 2
2. BASE 2
3. EMITTER 1
4. COLLECTOR
5. COLLECTOR 2/BASE 1

#### STYLE 7:

1. BASE
2. EMITTER
3. BASE
4. COLLECTOR
5. COLLECTOR

#### STYLE 8:

1. CATHODE
2. COLLECTOR
3. N/C
4. BASE
5. EMITTER

#### STYLE 9:

1. ANODE
2. CATHODE
3. ANODE
4. ANODE
5. ANODE

Note: Please refer to datasheet for style callout. If style type is not called out in the datasheet refer to the device datasheet pinout or pin assignment.

|                         |                                 |   |
|-------------------------|---------------------------------|---|
| <b>DOCUMENT NUMBER:</b> | <b>98ASB42984B</b>              | Electronic versions are uncontrolled except when accessed directly from the Document Repository.<br>Printed versions are uncontrolled except when stamped "CONTROLLED COPY" in red. |
| <b>DESCRIPTION:</b>     | <b>SC-88A (SC-70-5/SOT-353)</b> | <b>PAGE 1 OF 1</b>  |

onsemi and ONSEMI are trademarks of Semiconductor Components Industries, LLC dba onsemi or its subsidiaries in the United States and/or other countries. onsemi reserves the right to make changes without further notice to any products herein. onsemi makes no warranty, representation or guarantee regarding the suitability of its products for any particular purpose, nor does onsemi assume any liability arising out of the application or use of any product or circuit, and specifically disclaims any and all liability, including without limitation special, consequential or incidental damages. onsemi does not convey any license under its patent rights nor the rights of others.



# MECHANICAL CASE OUTLINE PACKAGE DIMENSIONS

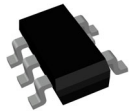

## TSOP-5 3.00x1.50x0.95, 0.95P CASE 483 ISSUE P

DATE 01 APR 2024

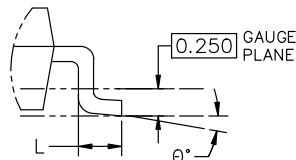

NOTES:

1. DIMENSIONING AND TOLERANCING CONFORM TO ASME Y14.5-2018.
2. ALL DIMENSION ARE IN MILLIMETERS (ANGLES IN DEGREES).
3. MAXIMUM LEAD THICKNESS INCLUDES LEAD FINISH THICKNESS. MINIMUM LEAD THICKNESS IS THE MINIMUM THICKNESS OF BASE MATERIAL.
4. DIMENSIONS D AND E1 DO NOT INCLUDE MOLD FLASH, PROTRUSIONS OF GATE BURRS. MOLD FLASH, PROTRUSIONS, OR GATE BURRS SHALL NOT EXCEED 0.15 PER SIDE. DIMENSION D.
5. OPTIONAL CONSTRUCTION: AN ADDITIONAL TRIMMED LEAD IS ALLOWED IN THIS LOCATION. TRIMMED LEAD NOT TO EXTEND MORE THAN 0.2 FROM BODY.

| DIM      | MILLIMETERS |       |       |
|----------|-------------|-------|-------|
|          | MIN.        | NOM.  | MAX.  |
| A        | 0.900       | 1.000 | 1.100 |
| A1       | 0.010       | 0.055 | 0.100 |
| A2       | 0.950 REF.  |       |       |
| b        | 0.250       | 0.375 | 0.500 |
| c        | 0.100       | 0.180 | 0.260 |
| D        | 2.850       | 3.000 | 3.150 |
| E        | 2.500       | 2.750 | 3.000 |
| E1       | 1.350       | 1.500 | 1.650 |
| e        | 0.950 BSC   |       |       |
| L        | 0.200       | 0.400 | 0.600 |
| $\theta$ | 0°          | 5°    | 10°   |

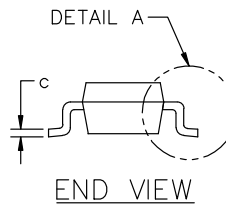

### GENERIC MARKING DIAGRAM\*

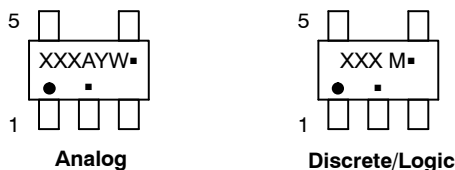

- XXX = Specific Device Code    XXX = Specific Device Code  
 A = Assembly Location        M = Date Code  
 Y = Year                            ▪ = Pb-Free Package  
 W = Work Week
- = Pb-Free Package

(Note: Microdot may be in either location)

\*This information is generic. Please refer to device data sheet for actual part marking. Pb-Free indicator, "G" or microdot "▪", may or may not be present. Some products may not follow the Generic Marking.

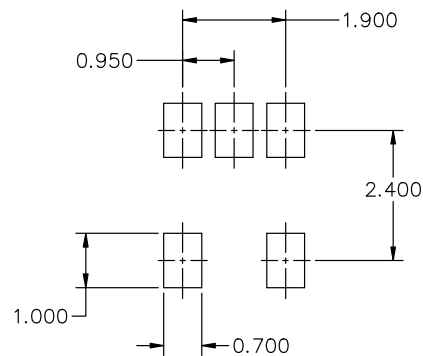

\* FOR ADDITIONAL INFORMATION ON OUR Pb-FREE STRATEGY AND SOLDERING DETAILS, PLEASE DOWNLOAD THE ON SEMICONDUCTOR SOLDERING AND MOUNTING TECHNIQUES REFERENCE MANUAL, SOLDERM/D.

|                         |                                     |  |
|-------------------------|-------------------------------------|--|
| <b>DOCUMENT NUMBER:</b> | <b>98ARB18753C</b>                  | Electronic versions are uncontrolled except when accessed directly from the Document Repository. Printed versions are uncontrolled except when stamped "CONTROLLED COPY" in red. |
| <b>DESCRIPTION:</b>     | <b>TSOP-5 3.00x1.50x0.95, 0.95P</b> | <b>PAGE 1 OF 1</b>   |

onsemi and ONSEMI are trademarks of Semiconductor Components Industries, LLC dba onsemi or its subsidiaries in the United States and/or other countries. onsemi reserves the right to make changes without further notice to any products herein. onsemi makes no warranty, representation or guarantee regarding the suitability of its products for any particular purpose, nor does onsemi assume any liability arising out of the application or use of any product or circuit, and specifically disclaims any and all liability, including without limitation special, consequential or incidental damages. onsemi does not convey any license under its patent rights nor the rights of others.

**onsemi**, **Onsemi**, and other names, marks, and brands are registered and/or common law trademarks of Semiconductor Components Industries, LLC dba "**onsemi**" or its affiliates and/or subsidiaries in the United States and/or other countries. **onsemi** owns the rights to a number of patents, trademarks, copyrights, trade secrets, and other intellectual property. A listing of **onsemi**'s product/patent coverage may be accessed at [www.onsemi.com/site/pdf/Patent-Marking.pdf](http://www.onsemi.com/site/pdf/Patent-Marking.pdf). **onsemi** reserves the right to make changes at any time to any products or information herein, without notice. The information herein is provided "as-is" and **onsemi** makes no warranty, representation or guarantee regarding the accuracy of the information, product features, availability, functionality, or suitability of its products for any particular purpose, nor does **onsemi** assume any liability arising out of the application or use of any product or circuit, and specifically disclaims any and all liability, including without limitation special, consequential or incidental damages. Buyer is responsible for its products and applications using **onsemi** products, including compliance with all laws, regulations and safety requirements or standards, regardless of any support or applications information provided by **onsemi**. "Typical" parameters which may be provided in **onsemi** data sheets and/or specifications can and do vary in different applications and actual performance may vary over time. All operating parameters, including "Typicals" must be validated for each customer application by customer's technical experts. **onsemi** does not convey any license under any of its intellectual property rights nor the rights of others. **onsemi** products are not designed, intended, or authorized for use as a critical component in life support systems or any FDA Class 3 medical devices or medical devices with a same or similar classification in a foreign jurisdiction or any devices intended for implantation in the human body. Should Buyer purchase or use **onsemi** products for any such unintended or unauthorized application, Buyer shall indemnify and hold **onsemi** and its officers, employees, subsidiaries, affiliates, and distributors harmless against all claims, costs, damages, and expenses, and reasonable attorney fees arising out of, directly or indirectly, any claim of personal injury or death associated with such unintended or unauthorized use, even if such claim alleges that **onsemi** was negligent regarding the design or manufacture of the part. **onsemi** is an Equal Opportunity/Affirmative Action Employer. This literature is subject to all applicable copyright laws and is not for resale in any manner.

## ADDITIONAL INFORMATION

### TECHNICAL PUBLICATIONS:

Technical Library: [www.onsemi.com/design/resources/technical-documentation](http://www.onsemi.com/design/resources/technical-documentation)  
onsemi Website: [www.onsemi.com](http://www.onsemi.com)

### ONLINE SUPPORT: [www.onsemi.com/support](http://www.onsemi.com/support)

For additional information, please contact your local Sales Representative at [www.onsemi.com/support/sales](http://www.onsemi.com/support/sales)