

# NCP4683

## 300 mA, Low Dropout Regulator

The NCP4683 is a CMOS Linear voltage regulator with 300 mA output current capability. The device has high output voltage accuracy, low supply current and high ripple rejection. The NCP4683 is easy to use, with output current fold-back protection circuit included. A Chip Enable function is included to save power by lowering supply current. The line and load transient responses are very good, thus this regulator is suitable for use as a power supply for communication equipment.

### Features

- Operating Input Voltage Range: 1.40 V to 5.25 V
- Output Voltage Range: 0.8 V to 3.6 V (available in 0.1 V steps)
- Output Voltage Accuracy:  $\pm 1.0\%$  ( $V_{OUT} > 2.0$  V)
- Supply Current: 50  $\mu$ A
- Dropout Voltage: 0.25 V ( $I_{OUT} = 300$  mA,  $V_{OUT} = 2.8$  V)
- High PSRR: 70 dB ( $f = 1$  kHz)
- Line Regulation: 0.02%/V Typ.
- Stable with Ceramic Capacitors: 1.0  $\mu$ F or more
- Current Fold Back Protection
- Available in UDFN4 1.0 x 1.0 mm, SC-70, SOT23 Packages
- These are Pb-Free Devices

### Typical Applications

- Battery-powered Equipment
- Networking and Communication Equipment
- Cameras, DVRs, STB and Camcorders
- Home Appliances

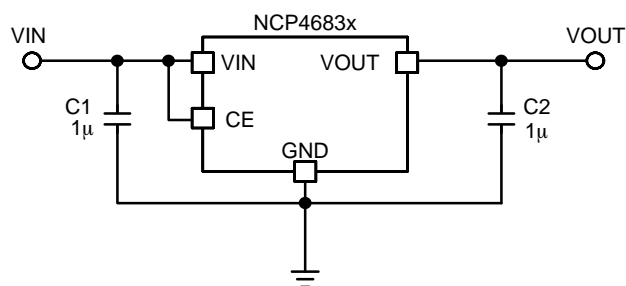

Figure 1. Typical Application Schematic



ON Semiconductor®

[www.onsemi.com](http://www.onsemi.com)

### MARKING DIAGRAMS



SOT-23-5  
CASE 1212



SC-70  
CASE 419A

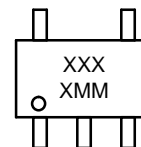

UDFN4  
CASE 517BR

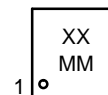

XX, XXX, XXXX = Specific Device Code  
M, MM = Date Code

### ORDERING INFORMATION

See detailed ordering, marking and shipping information in the package dimensions section on page 18 of this data sheet.

# NCP4683

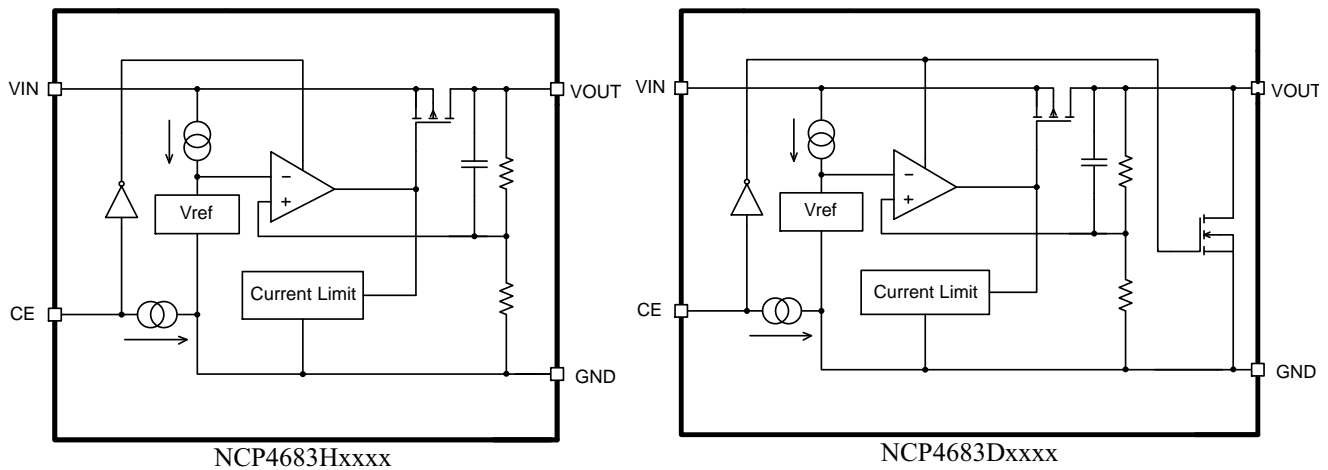

Figure 2. Simplified Schematic Block Diagram

## PIN FUNCTION DESCRIPTION

| Pin No. UDFN1010* | Pin No. SC-70 | Pin No. SOT23 | Pin Name         | Description                  |
|-------------------|---------------|---------------|------------------|------------------------------|
| 1                 | 4             | 5             | V <sub>OUT</sub> | Output pin                   |
| 2                 | 3             | 2             | GND              | Ground                       |
| 3                 | 1             | 3             | CE               | Chip enable pin (Active "H") |
| 4                 | 5             | 1             | V <sub>IN</sub>  | Input pin                    |
| -                 | 2             | 4             | NC               | No connection                |

\*Tab is GND level. (They are connected to the reverse side of this IC.  
The tab is better to be connected to the GND, but leaving it open is also acceptable.

## ABSOLUTE MAXIMUM RATINGS

| Rating                                    | Symbol             | Value                         | Unit |
|---|--------------------|-------------------------------|------|
| Input Voltage (Note 1)                    | V <sub>IN</sub>    | 6.0                           | V    |
| Output Voltage                            | V <sub>OUT</sub>   | -0.3 to V <sub>IN</sub> + 0.3 | V    |
| Chip Enable Input                         | V <sub>CE</sub>    | -0.3 to 6.0                   | V    |
| Output Current                            | I <sub>OUT</sub>   | 400                           | mA   |
| Power Dissipation UDFN1010                | P <sub>D</sub>     | 400                           | mW   |
| Power Dissipation SC-70                   |                    | 380                           |      |
| Power Dissipation SOT23                   |                    | 420                           |      |
| Junction Temperature                      | T <sub>J</sub>     | -40 to 150                    | °C   |
| Storage Temperature                       | T <sub>STG</sub>   | -55 to 125                    | °C   |
| ESD Capability, Human Body Model (Note 2) | ESD <sub>HBM</sub> | 2000                          | V    |
| ESD Capability, Machine Model (Note 2)    | ESD <sub>MM</sub>  | 200                           | V    |

Stresses exceeding those listed in the Maximum Ratings table may damage the device. If any of these limits are exceeded, device functionality should not be assumed, damage may occur and reliability may be affected.

- Refer to ELECTRICAL CHARACTERISTICS and APPLICATION INFORMATION for Safe Operating Area.
- This device series incorporates ESD protection and is tested by the following methods:  
ESD Human Body Model tested per AEC-Q100-002 (EIA/JESD22-A114)  
ESD Machine Model tested per AEC-Q100-003 (EIA/JESD22-A115)  
Latchup Current Maximum Rating tested per JEDEC standard: JESD78.

# NCP4683

## THERMAL CHARACTERISTICS

| Rating  | Symbol          | Value | Unit                        |
|---|-----------------|-------|-----------------------------|
| Thermal Characteristics, UDFN 1.0 x 1.0 mm<br>Thermal Resistance, Junction-to-Air | $R_{\theta JA}$ | 250   | $^{\circ}\text{C}/\text{W}$ |
| Thermal Characteristics, SOT23<br>Thermal Resistance, Junction-to-Air             | $R_{\theta JA}$ | 238   | $^{\circ}\text{C}/\text{W}$ |
| Thermal Characteristics, SC-70<br>Thermal Resistance, Junction-to-Air             | $R_{\theta JA}$ | 263   | $^{\circ}\text{C}/\text{W}$ |

## ELECTRICAL CHARACTERISTICS

$-40^{\circ}\text{C} \leq T_A \leq 85^{\circ}\text{C}$ ;  $V_{IN} = V_{OUT(NOM)} + 1\text{ V}$  or  $2.5\text{ V}$ , whichever is greater;  $I_{OUT} = 1\text{ mA}$ ,  $C_{IN} = C_{OUT} = 1.0\text{ }\mu\text{F}$ , unless otherwise noted. Typical values are at  $T_A = +25^{\circ}\text{C}$ .

| Parameter                        | Test Conditions   | Symbol                      | Min  | Typ      | Max  | Unit                    |    |
|----------------------------------|---|-----------------------------|--|----------|------|-------------------------|----|
| Operating Input Voltage          |   | $V_{IN}$                    | 1.40                                       |          | 5.25 | V                       |    |
| Output Voltage                   | $T_A = +25^{\circ}\text{C}$   | $V_{OUT}$                   | $V_{OUT} \geq 2.0\text{ V}$                | x0.99    |      | x1.01                   | V  |
|                                  |   |                             | $V_{OUT} < 2.0\text{ V}$                   | -20      |      | 20                      | mV |
|                                  | $-40^{\circ}\text{C} \leq T_A \leq 85^{\circ}\text{C}$  |                             | $V_{OUT} \geq 2.0\text{ V}$                | x0.97    |      | x1.03                   | V  |
|                                  |   |                             | $V_{OUT} < 2.0\text{ V}$                   | -60      |      | 60                      | mV |
| Output Voltage Temp. Coefficient | $-40^{\circ}\text{C} \leq T_A \leq 85^{\circ}\text{C}$  | $\Delta V_{OUT}/\Delta T_A$ |  | $\pm 80$ |      | ppm/ $^{\circ}\text{C}$ |    |
| Line Regulation                  | $V_{OUT(NOM)} + 0.5\text{ V} \leq V_{IN} \leq 5.0\text{ V}$   | $Line_{Reg}$                |  | 0.02     | 0.10 | %/V                     |    |
| Load Regulation                  | $I_{OUT} = 1\text{ mA}$ to $300\text{ mA}$  | $Load_{Reg}$                |  | 15       | 40   | mV                      |    |
| Dropout Voltage                  | $I_{OUT} = 300\text{ mA}$   | $V_{DO}$                    | $V_{OUT} = 0.8\text{ V}$                   |          | 0.56 | 0.72                    | V  |
|                                  |   |                             | $V_{OUT} = 0.9\text{ V}$                   |          | 0.51 | 0.65                    |    |
|                                  |   |                             | $1.0\text{ V} \leq V_{OUT} < 1.2\text{ V}$ |          | 0.46 | 0.59                    |    |
|                                  |   |                             | $1.2\text{ V} \leq V_{OUT} < 1.4\text{ V}$ |          | 0.39 | 0.50                    |    |
|                                  |   |                             | $1.4\text{ V} \leq V_{OUT} < 1.7\text{ V}$ |          | 0.35 | 0.44                    |    |
|                                  |   |                             | $1.7\text{ V} \leq V_{OUT} < 2.1\text{ V}$ |          | 0.30 | 0.39                    |    |
|                                  |   |                             | $2.1\text{ V} \leq V_{OUT} < 2.5\text{ V}$ |          | 0.26 | 0.34                    |    |
|                                  |   |                             | $2.5\text{ V} \leq V_{OUT} < 3.0\text{ V}$ |          | 0.25 | 0.30                    |    |
|                                  |   |                             | $3.0\text{ V} \leq V_{OUT} < 3.6\text{ V}$ |          | 0.22 | 0.29                    |    |
| Output Current                   |   | $I_{OUT}$                   | 300  |          |      | mA                      |    |
| Short Current Limit              | $V_{OUT} = 0\text{ V}$  | $I_{SC}$                    |  | 60       |      | mA                      |    |
| Quiescent Current                |   | $I_Q$                       |  | 50       | 75   | $\mu\text{A}$           |    |
| Standby Current                  | $V_{CE} = 0\text{ V}$ , $T_A = 25^{\circ}\text{C}$  | $I_{STB}$                   |  | 0.1      | 1.0  | $\mu\text{A}$           |    |
| CE Pin Threshold Voltage         | CE Input Voltage "H"  | $V_{CEH}$                   | 1.0  |          |      | V                       |    |
|                                  | CE Input Voltage "L"  | $V_{CEL}$                   |  |          | 0.4  |                         |    |
| CE Pull Down Current             |   | $I_{CEPD}$                  |  | 0.3      |      | $\mu\text{A}$           |    |
| Power Supply Rejection Ratio     | $V_{IN} = V_{OUT} + 1\text{ V}$ or $V_{IN} = 3\text{ V}$ ,<br>$\Delta V_{IN} = 0.2\text{ V}_{pk-pk}$ ,<br>$I_{OUT} = 30\text{ mA}$ , $f = 1\text{ kHz}$ | PSRR                        |  | 65       |      | dB                      |    |
| Output Noise Voltage             | $f = 10\text{ Hz}$ to $100\text{ kHz}$ , $I_{OUT} = 30\text{ mA}$ ,<br>$V_{OUT} = 1.2\text{ V}$ , $V_{IN} = 3.2\text{ V}$                               | $V_N$                       |  | 65       |      | $\mu\text{V}_{rms}$     |    |
| Low Output Nch Tr. On Resistance | $V_{IN} = 4\text{ V}$ , $V_{CE} = 0\text{ V}$ , D version only  | $R_{LOW}$                   |  | 50       |      | $\Omega$                |    |

Product parametric performance is indicated in the Electrical Characteristics for the listed test conditions, unless otherwise noted. Product performance may not be indicated by the Electrical Characteristics if operated under different conditions.

TYPICAL CHARACTERISTICS

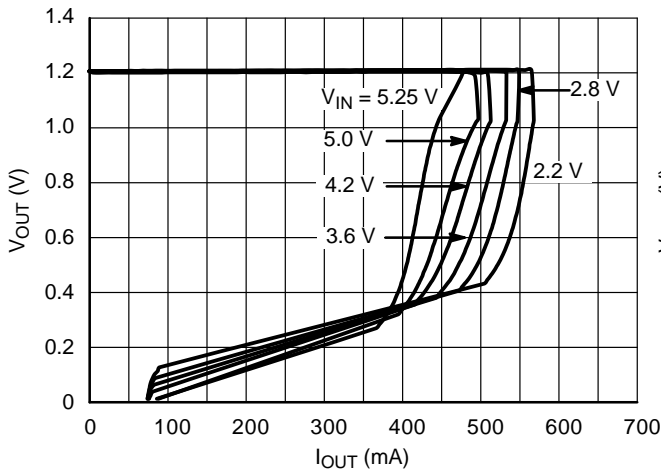

Figure 3. Output Voltage vs. Output Current  
1.2 V Version ( $T_J = 25^\circ\text{C}$ )

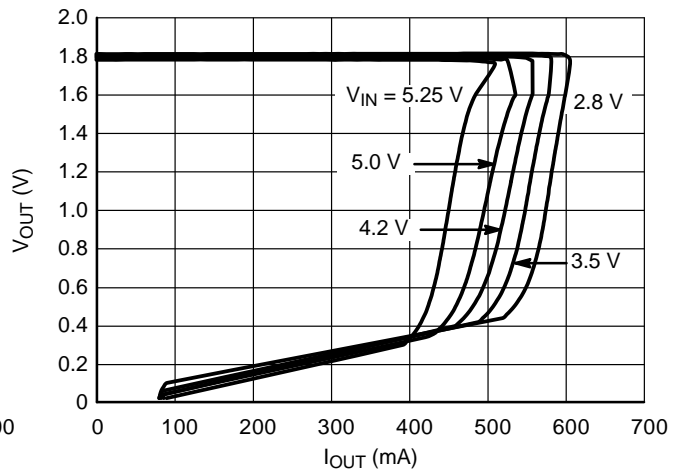

Figure 4. Output Voltage vs. Output Current  
1.8 V Version ( $T_J = 25^\circ\text{C}$ )

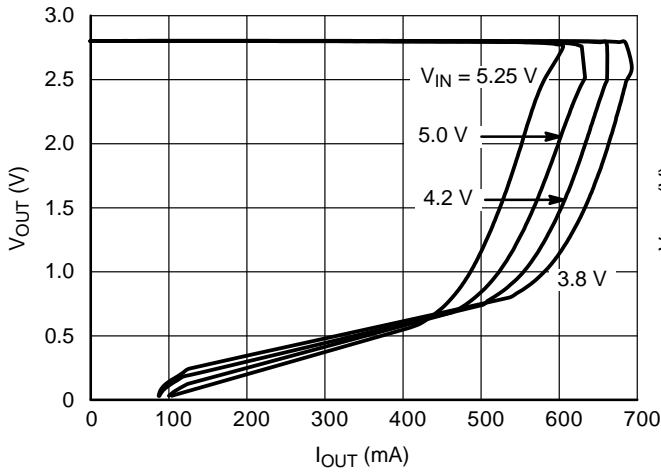

Figure 5. Output Voltage vs. Output Current  
2.8 V Version ( $T_J = 25^\circ\text{C}$ )

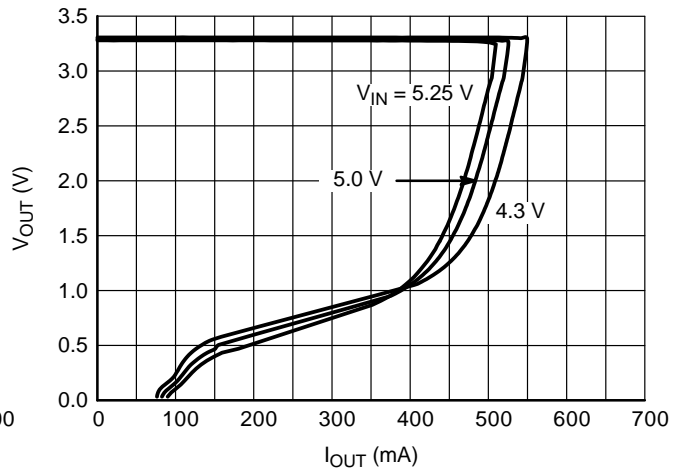

Figure 6. Output Voltage vs. Output Current  
3.3 V Version ( $T_J = 25^\circ\text{C}$ )

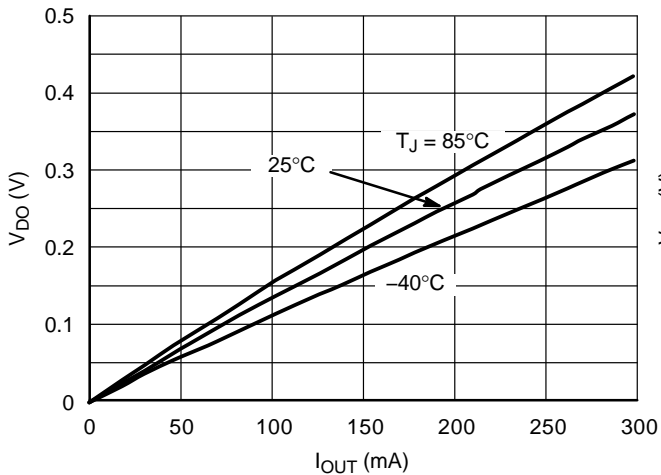

Figure 7. Dropout Voltage vs. Output Current  
1.2 V Version

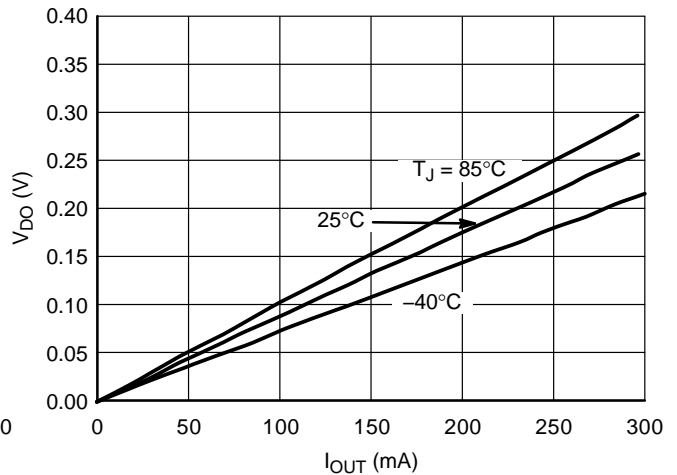

Figure 8. Dropout Voltage vs. Output Current  
1.8 V Version

TYPICAL CHARACTERISTICS

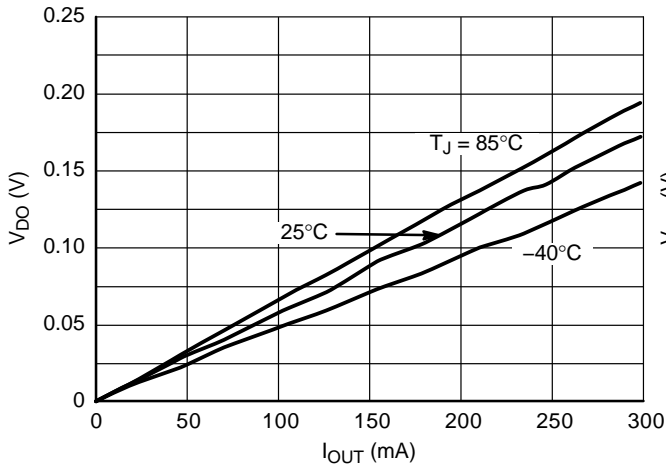

Figure 9. Dropout Voltage vs. Output Current  
2.8 V Version

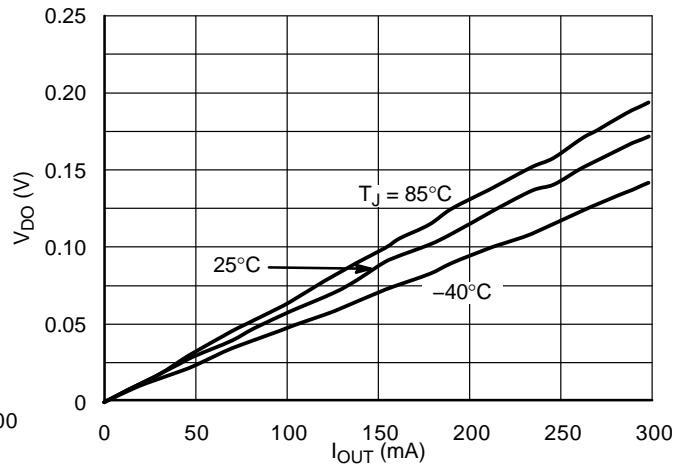

Figure 10. Dropout Voltage vs. Output Current  
3.3 V Version

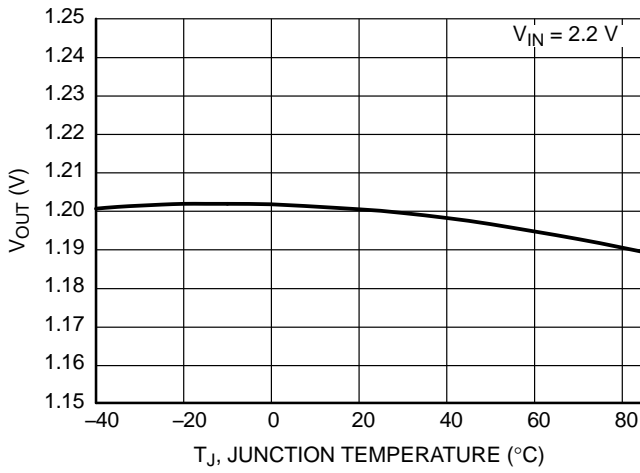

Figure 11. Output Voltage vs. Temperature,  
1.2 V Version

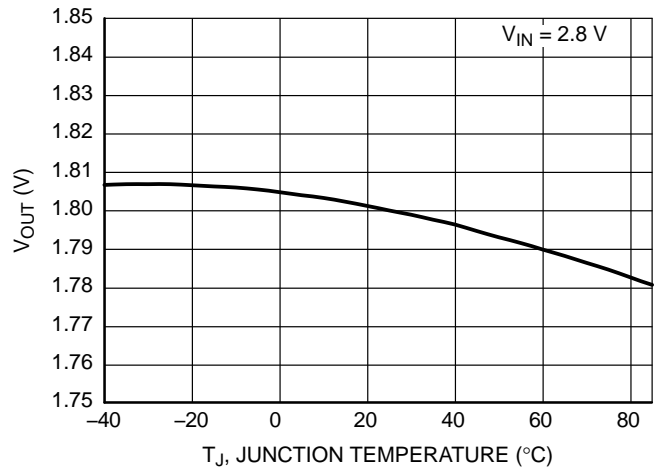

Figure 12. Output Voltage vs. Temperature,  
1.8 V Version

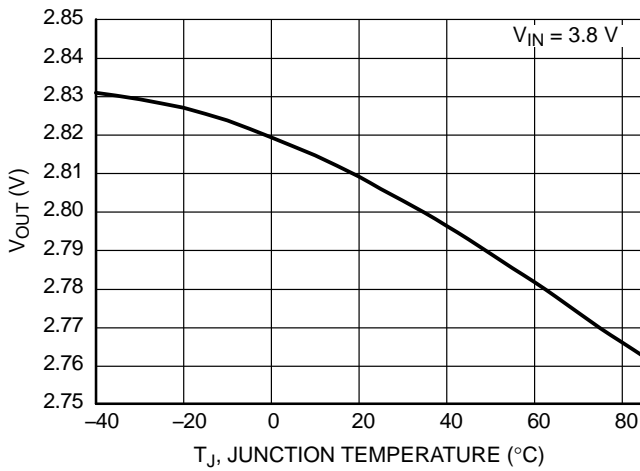

Figure 13. Output Voltage vs. Temperature,  
2.8 V Version

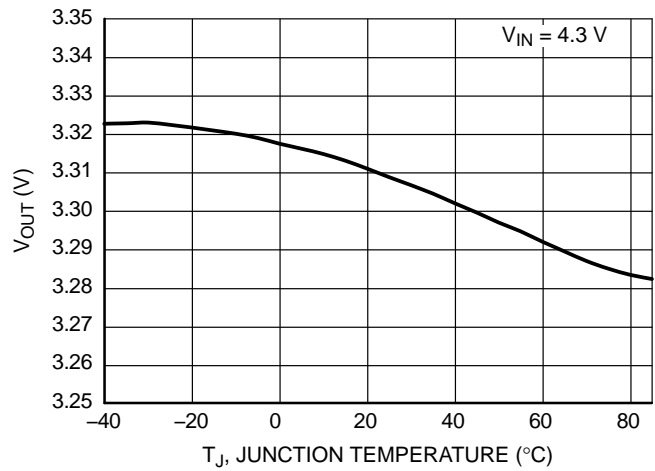

Figure 14. Output Voltage vs. Temperature,  
3.3 V Version

TYPICAL CHARACTERISTICS

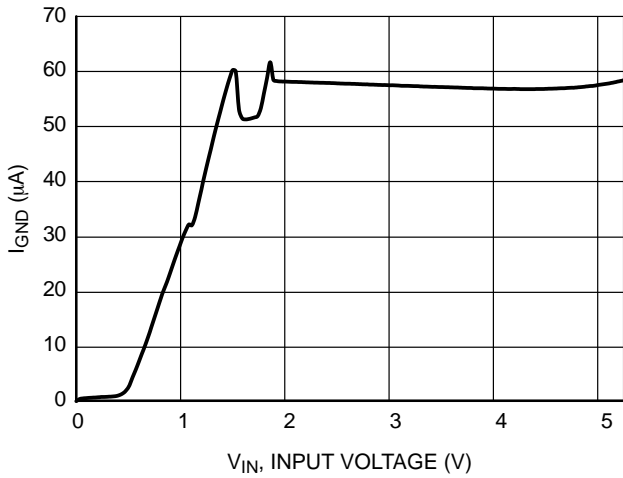

Figure 15. Supply Current vs. Input Voltage, 1.2 V Version

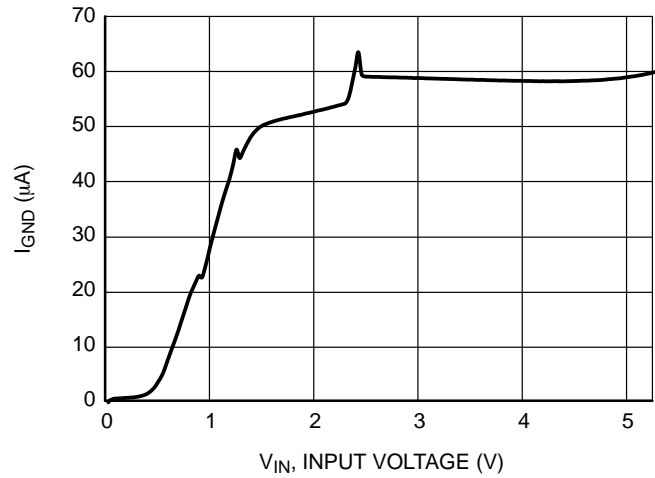

Figure 16. Supply Current vs. Input Voltage, 1.8 V Version

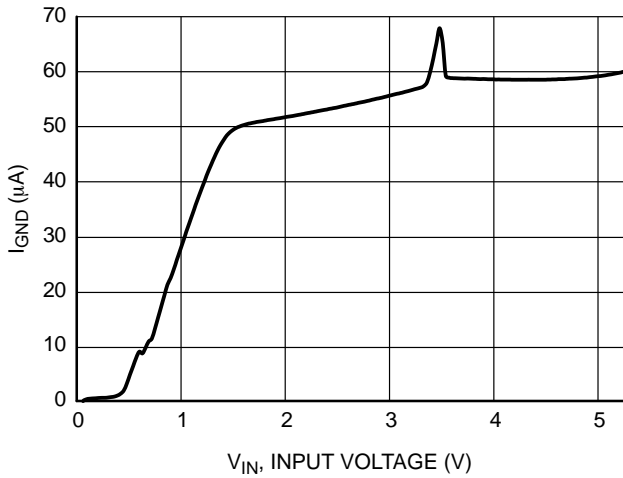

Figure 17. Supply Current vs. Input Voltage, 2.8 V Version

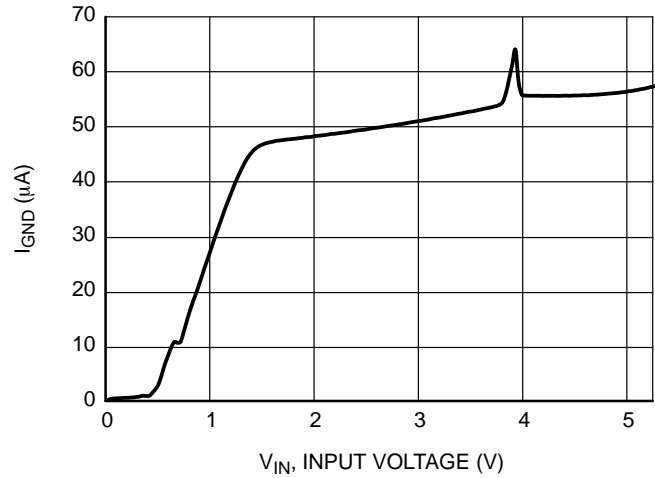

Figure 18. Supply Current vs. Input Voltage, 3.3 V Version

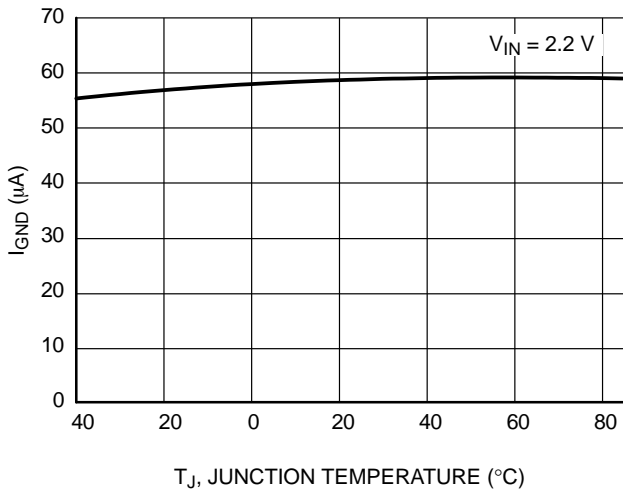

Figure 19. Supply Current vs. Temperature, 1.2 V Version

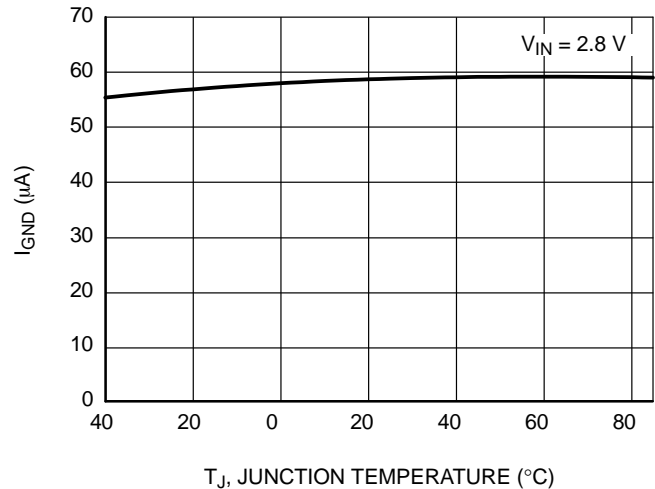

Figure 20. Supply Current vs. Temperature, 1.8 V Version

TYPICAL CHARACTERISTICS

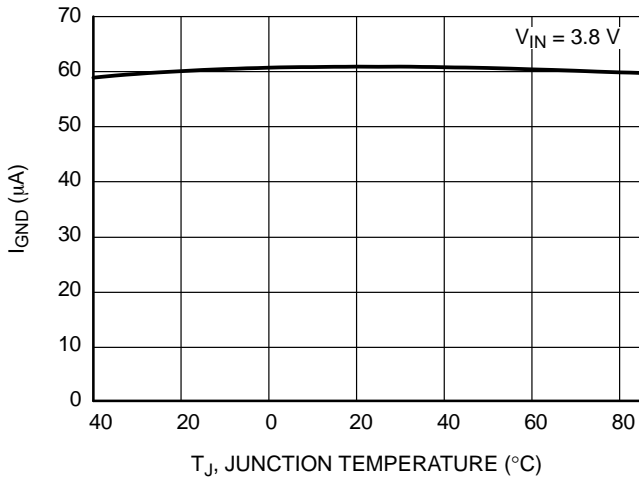

Figure 21. Supply Current vs. Temperature, 2.8 V Version

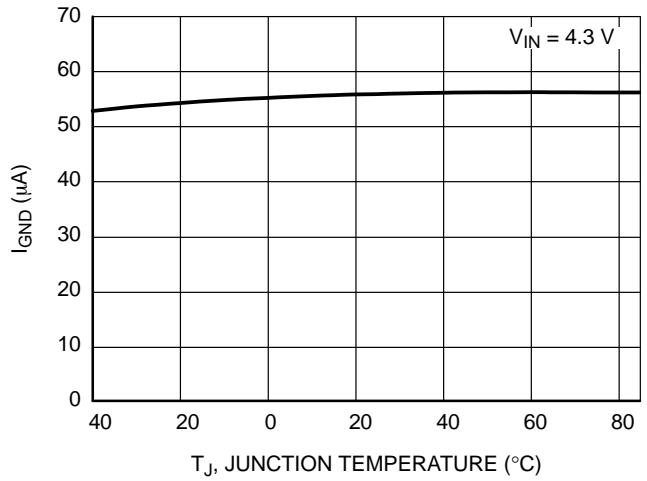

Figure 22. Supply Current vs. Temperature, 3.3 V Version

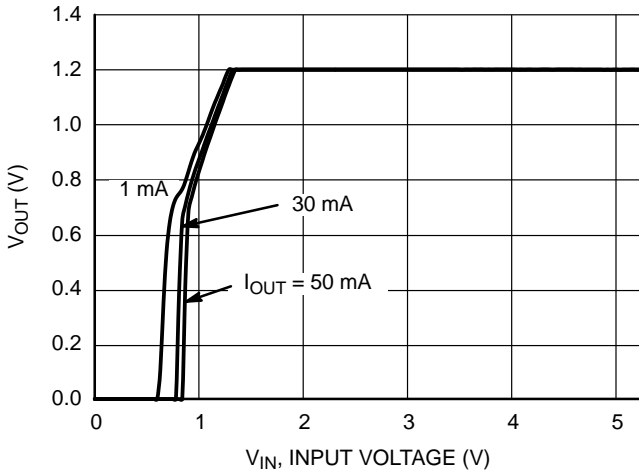

Figure 23. Output Voltage vs. Input Voltage, 1.2 V Version

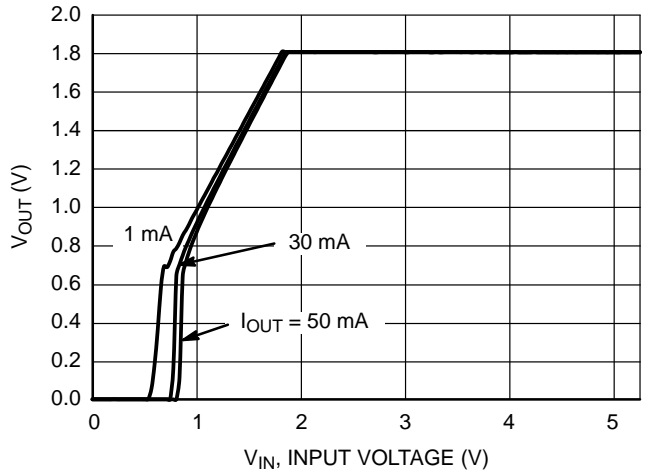

Figure 24. Output Voltage vs. Input Voltage, 1.8 V Version

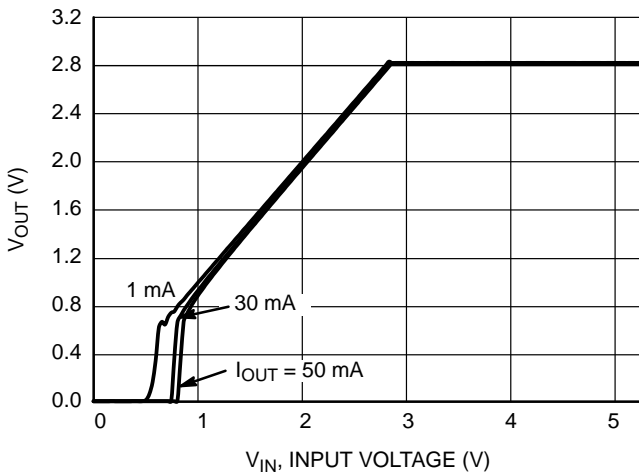

Figure 25. Output Voltage vs. Input Voltage, 2.8 V Version

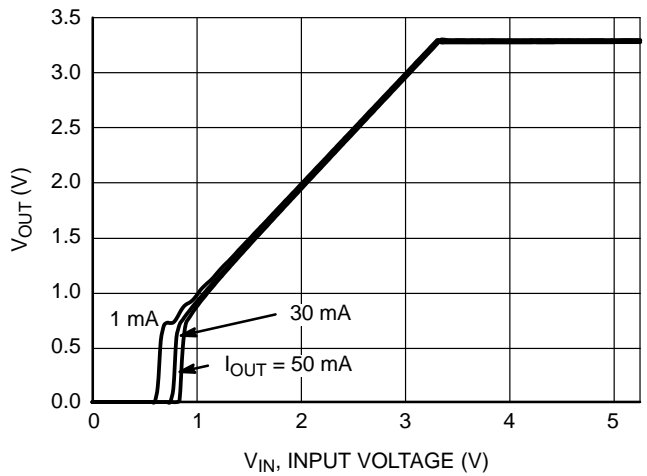

Figure 26. Output Voltage vs. Input Voltage, 3.3 V Version

TYPICAL CHARACTERISTICS

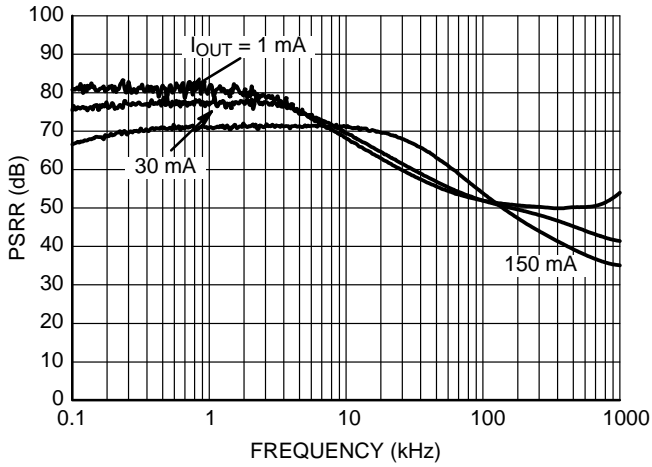

Figure 27. PSRR, 1.2 V Version,  $V_{IN} = 3.0\text{ V}$

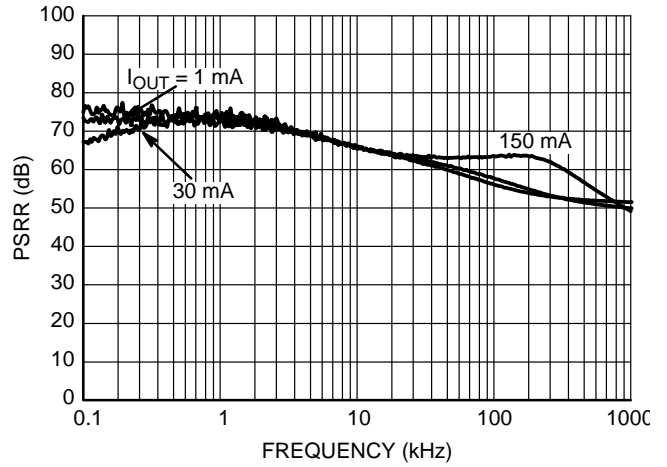

Figure 28. PSRR, 1.8 V Version,  $V_{IN} = 3.0\text{ V}$

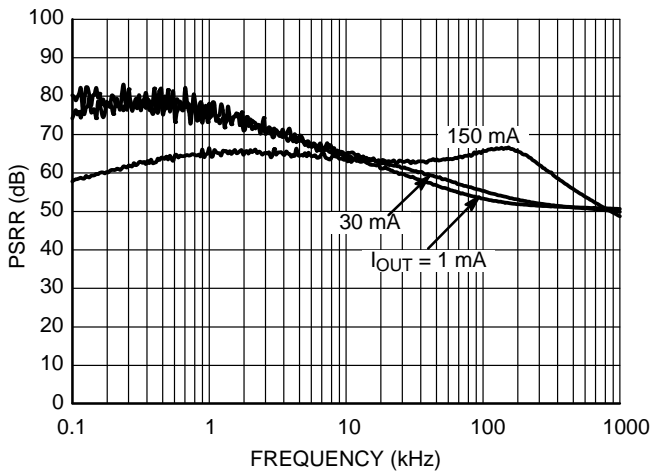

Figure 29. PSRR, 2.8 V Version,  $V_{IN} = 3.8\text{ V}$

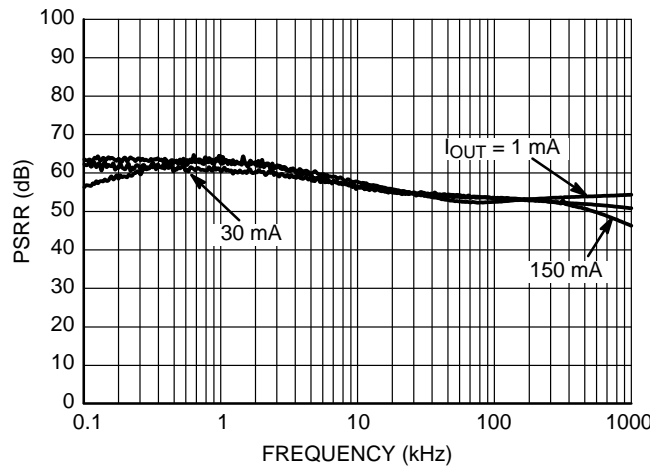

Figure 30. PSRR, 3.3 V Version,  $V_{IN} = 4.3\text{ V}$

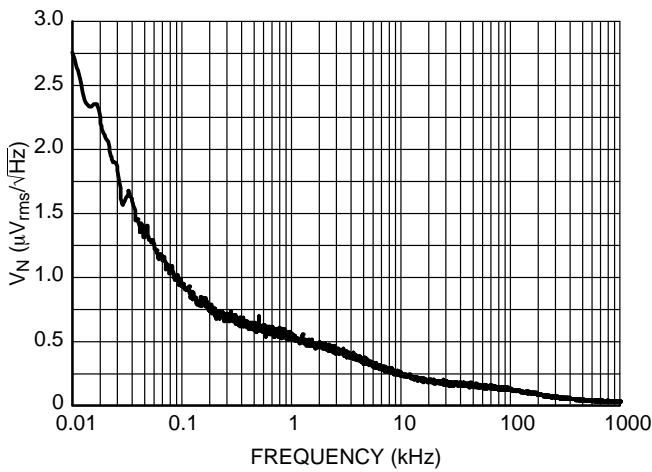

Figure 31. Output Voltage Noise, 1.2 V Version,  $V_{IN} = 2.2\text{ V}$

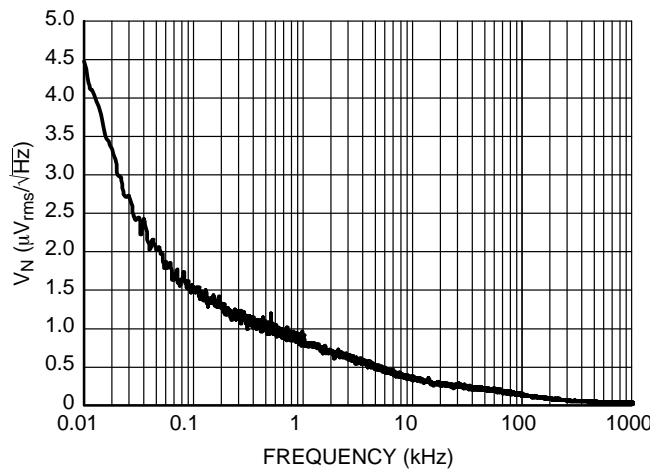

Figure 32. Output Voltage Noise, 1.8 V Version,  $V_{IN} = 2.8\text{ V}$



TYPICAL CHARACTERISTICS

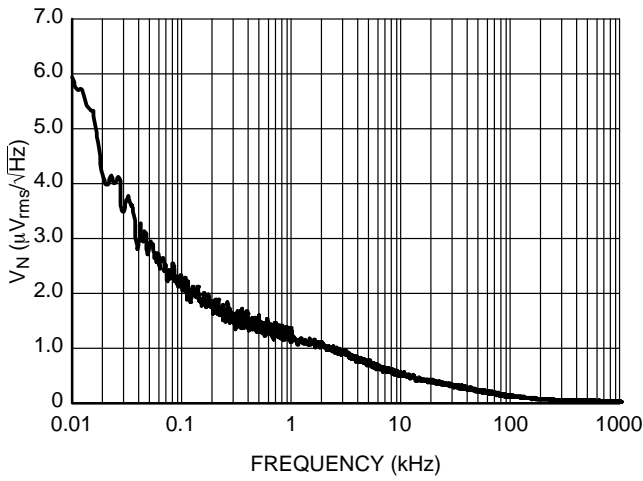

Figure 33. Output Voltage Noise, 2.8 V Version,  
 $V_{IN} = 3.8\text{ V}$

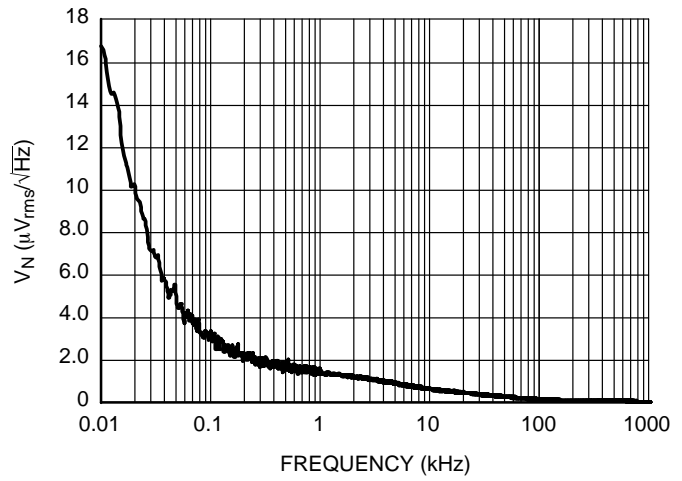

Figure 34. Output Voltage Noise, 3.3 V Version,  
 $V_{IN} = 4.3\text{ V}$

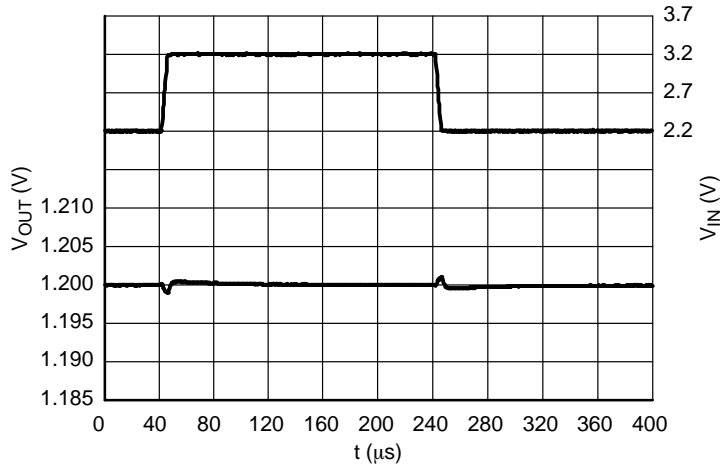

Figure 35. Line Transients, 1.2 V Version,  
 $t_R = t_F = 5\ \mu\text{s}$ ,  $I_{OUT} = 30\text{ mA}$

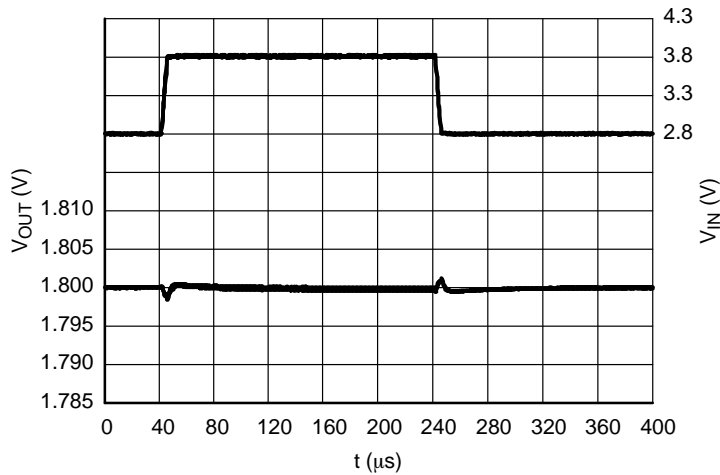

Figure 36. Line Transients, 1.8 V Version,  
 $t_R = t_F = 5\ \mu\text{s}$ ,  $I_{OUT} = 30\text{ mA}$

# NCP4683

## TYPICAL CHARACTERISTICS

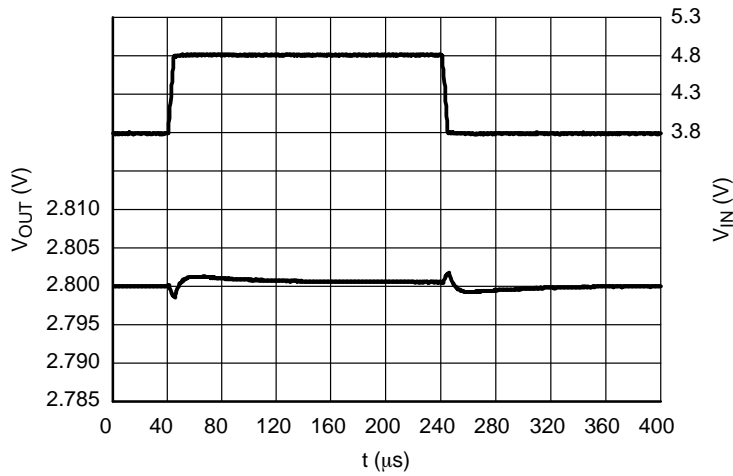

Figure 37. Line Transients, 2.8 V Version,  
 $t_{\text{R}} = t_{\text{F}} = 5 \mu\text{s}$ ,  $I_{\text{OUT}} = 30 \text{ mA}$

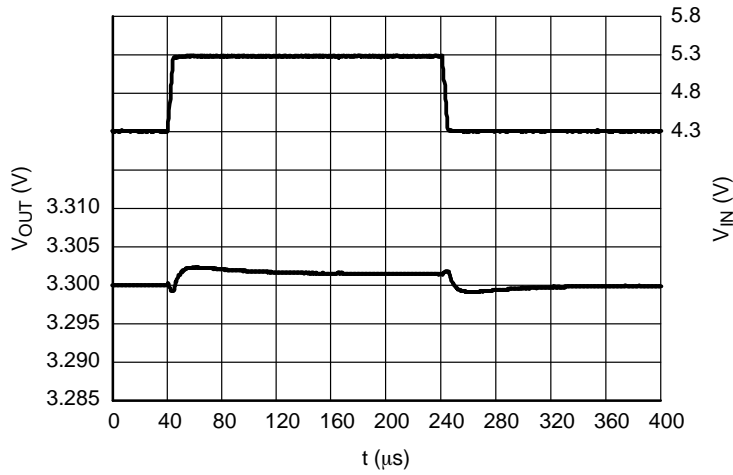

Figure 38. Line Transients, 3.3 V Version,  
 $t_{\text{R}} = t_{\text{F}} = 5 \mu\text{s}$ ,  $I_{\text{OUT}} = 30 \text{ mA}$

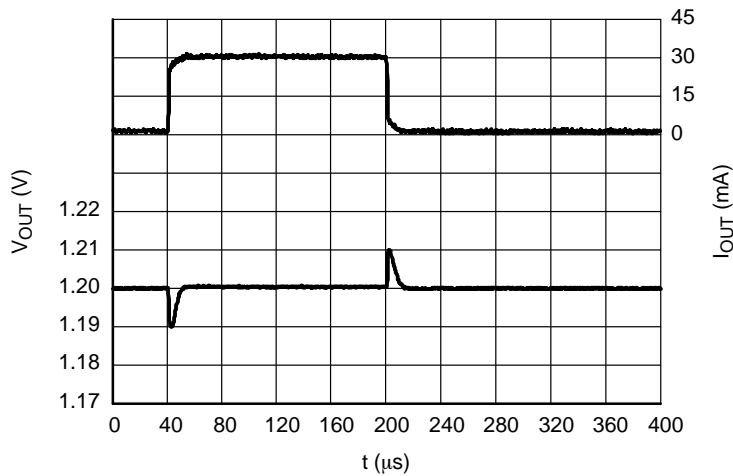

Figure 39. Load Transients, 1.2 V Version,  
 $I_{\text{OUT}} = 1 - 30 \text{ mA}$ ,  $t_{\text{R}} = t_{\text{F}} = 0.5 \mu\text{s}$ ,  $V_{\text{IN}} = 1.8 \text{ V}$

# NCP4683

## TYPICAL CHARACTERISTICS

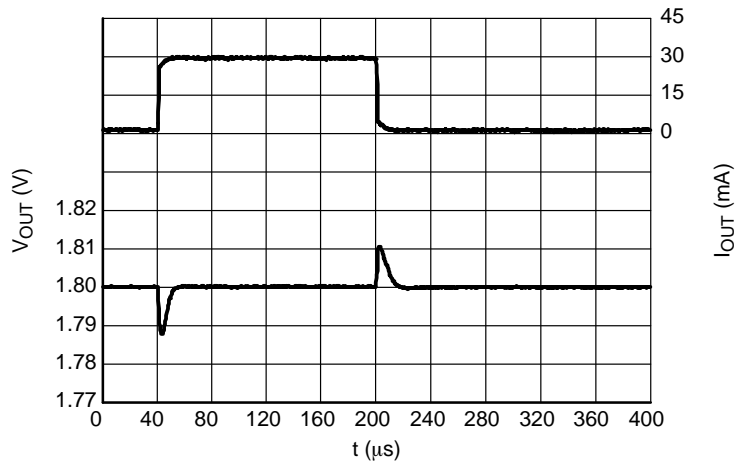

Figure 40. Load Transients, 1.8 V Version,  
 $I_{OUT} = 1 - 30$  mA,  $t_R = t_F = 0.5 \mu$ s,  $V_{IN} = 2.8$  V

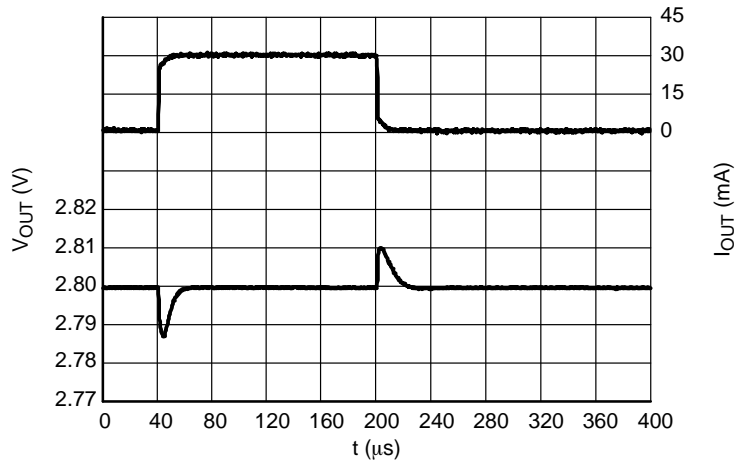

Figure 41. Load Transients, 2.8 V Version,  
 $I_{OUT} = 1 - 30$  mA,  $t_R = t_F = 0.5 \mu$ s,  $V_{IN} = 3.8$  V

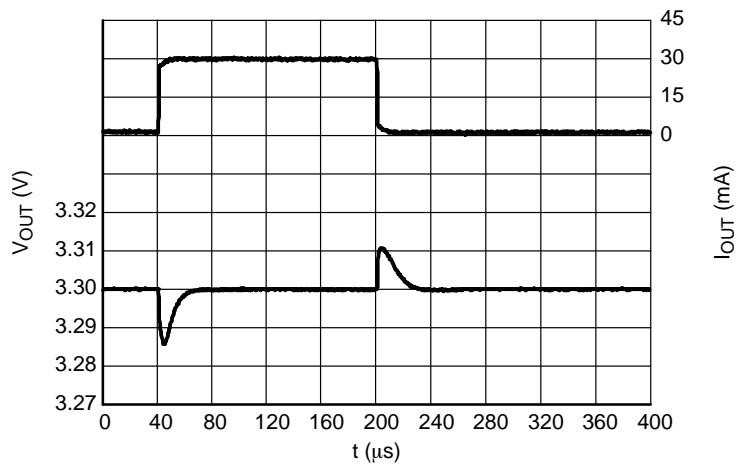
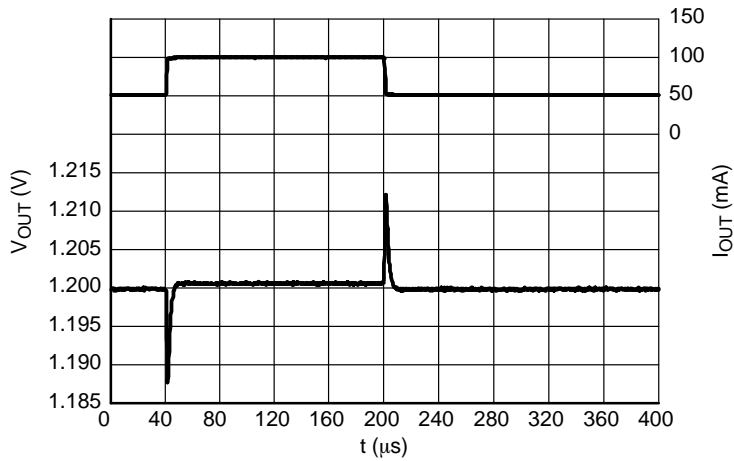

Figure 42. Load Transients, 3.3 V Version,  
 $I_{OUT} = 1 - 30$  mA,  $t_R = t_F = 0.5 \mu$ s,  $V_{IN} = 4.3$  V

# NCP4683

## TYPICAL CHARACTERISTICS



**Figure 43. Load Transients, 1.2 V Version,  
 $I_{OUT} = 50 - 100$  mA,  $t_R = t_F = 0.5$   $\mu$ s,  $V_{IN} = 1.8$  V**

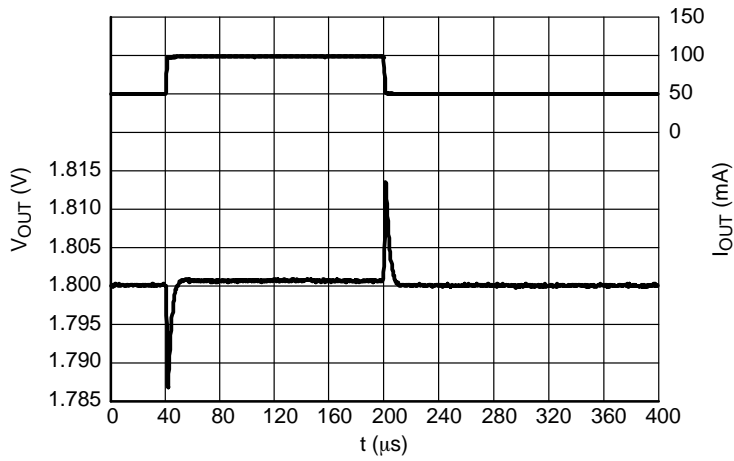

**Figure 44. Load Transients, 1.8 V Version,  
 $I_{OUT} = 50 - 100$  mA,  $t_R = t_F = 0.5$   $\mu$ s,  $V_{IN} = 2.8$  V**

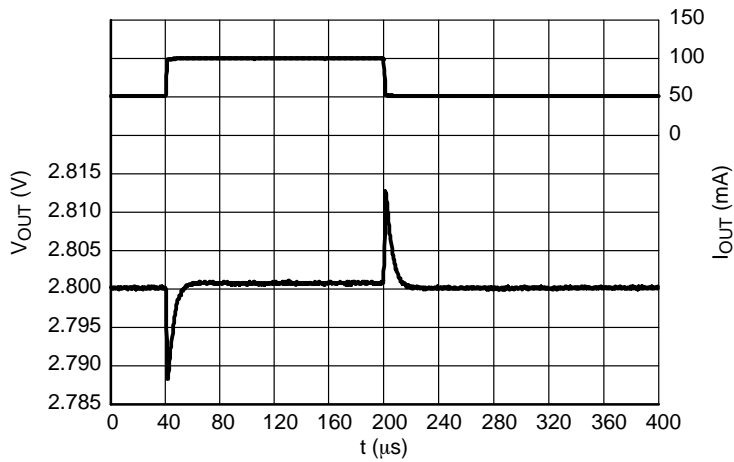

**Figure 45. Load Transients, 2.8 V Version,  
 $I_{OUT} = 50 - 100$  mA,  $t_R = t_F = 0.5$   $\mu$ s,  $V_{IN} = 3.8$  V**

# NCP4683

## TYPICAL CHARACTERISTICS

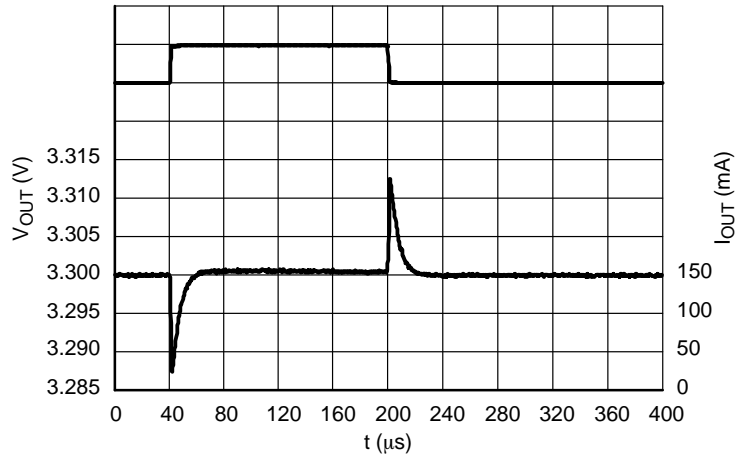

Figure 46. Load Transients, 3.3 V Version,  
 $I_{OUT} = 50 - 100 \text{ mA}$ ,  $t_R = t_F = 0.5 \mu\text{s}$ ,  $V_{IN} = 4.3 \text{ V}$

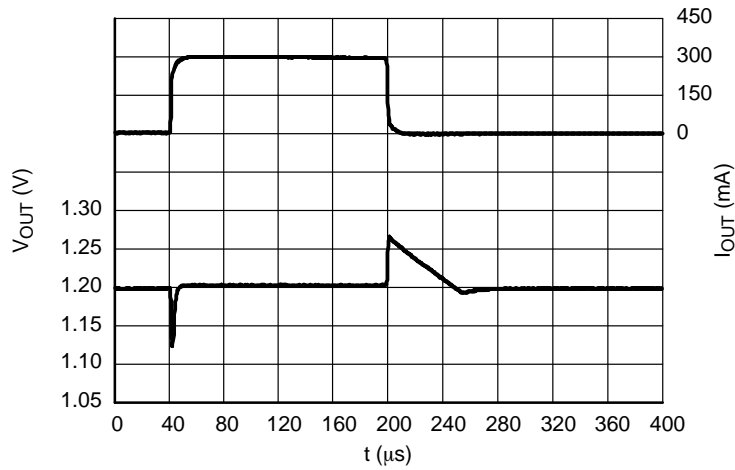

Figure 47. Load Transients, 1.2 V Version,  
 $I_{OUT} = 1 - 300 \text{ mA}$ ,  $t_R = t_F = 0.5 \mu\text{s}$ ,  $V_{IN} = 2.2 \text{ V}$

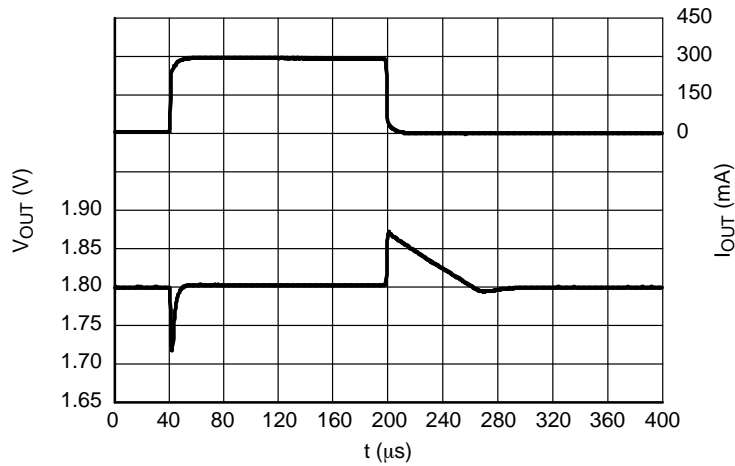
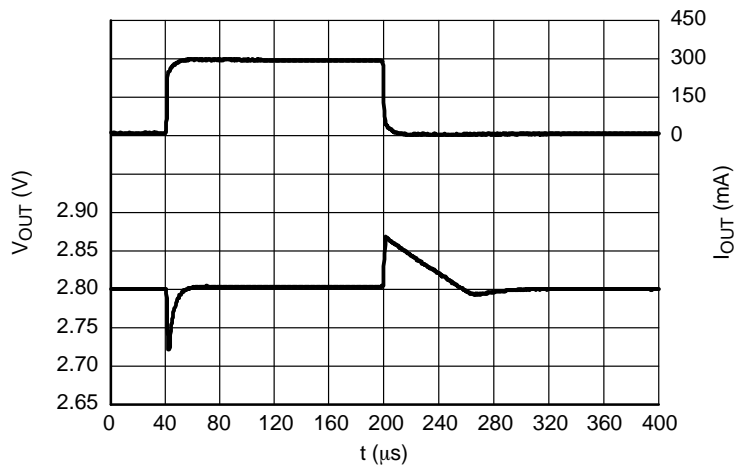

Figure 48. Load Transients, 1.8 V Version,  
 $I_{OUT} = 1 - 300 \text{ mA}$ ,  $t_R = t_F = 0.5 \mu\text{s}$ ,  $V_{IN} = 2.8 \text{ V}$

# NCP4683

## TYPICAL CHARACTERISTICS



**Figure 49. Load Transients, 2.8 V Version,  
 $I_{OUT} = 1 - 300 \text{ mA}$ ,  $t_R = t_F = 0.5 \mu\text{s}$ ,  $V_{IN} = 3.8 \text{ V}$**

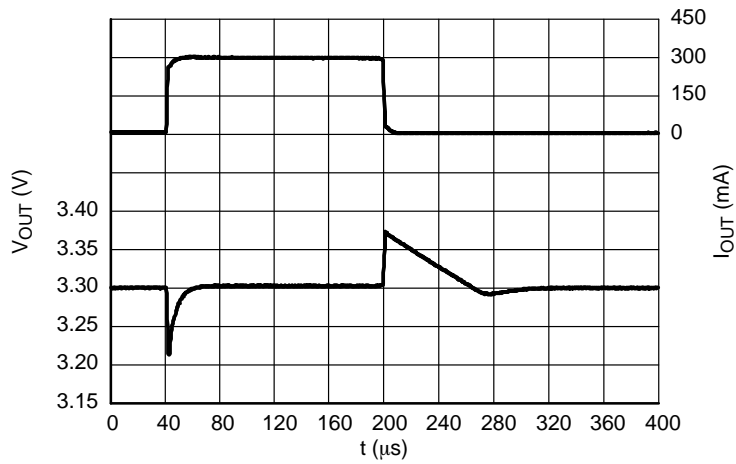

**Figure 50. Load Transients, 3.3 V Version,  
 $I_{OUT} = 1 - 300 \text{ mA}$ ,  $t_R = t_F = 0.5 \mu\text{s}$ ,  $V_{IN} = 4.3 \text{ V}$**

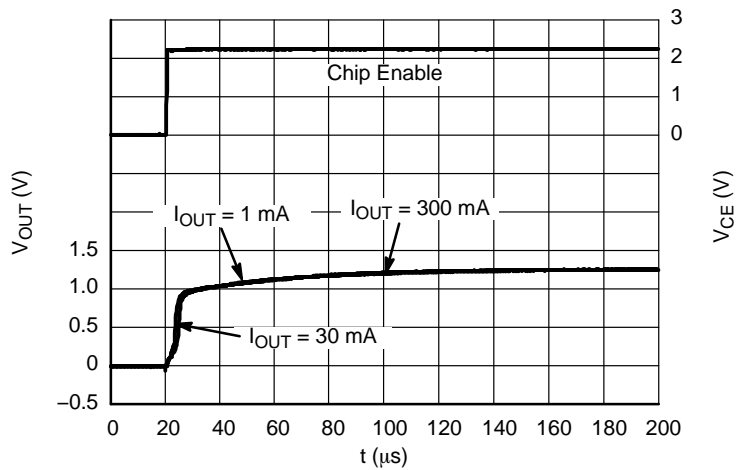

**Figure 51. Start-up, 1.2 V Version,  $V_{IN} = 2.2 \text{ V}$**

# NCP4683

## TYPICAL CHARACTERISTICS

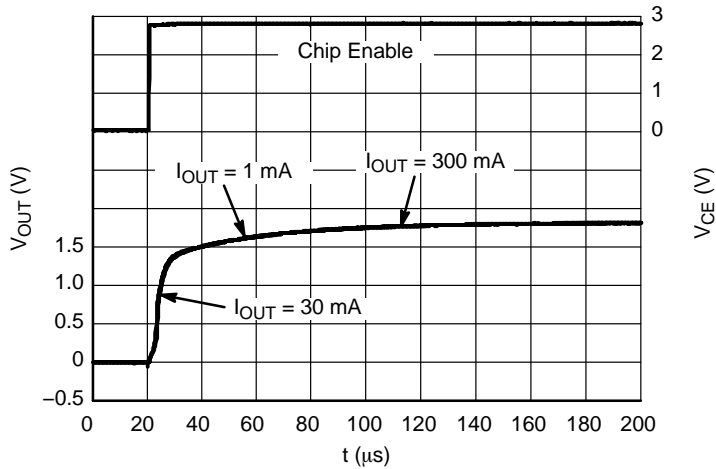

Figure 52. Start-up, 1.8 V Version,  $V_{IN} = 2.8$  V

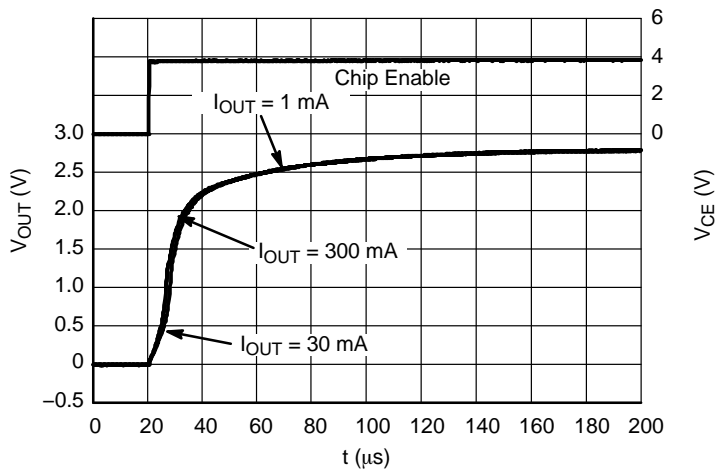

Figure 53. Start-up, 2.8 V Version,  $V_{IN} = 3.8$  V

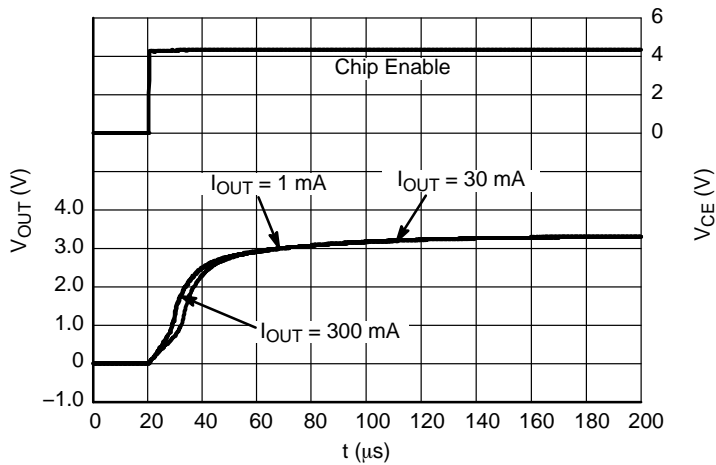

Figure 54. Start-up, 3.3 V Version,  $V_{IN} = 4.3$  V

# NCP4683

## TYPICAL CHARACTERISTICS

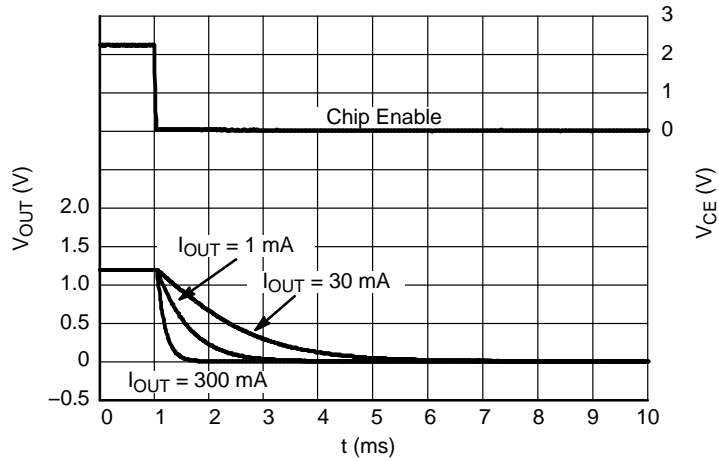

Figure 55. Shutdown, 1.2 V Version B,  
 $V_{IN} = 2.2 \text{ V}$

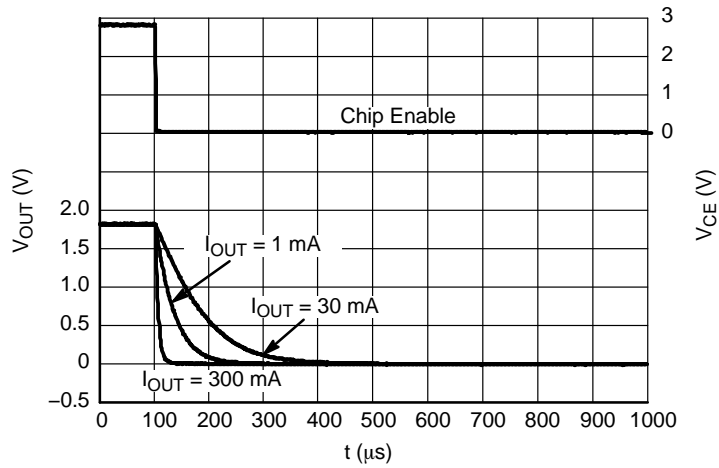

Figure 56. Shutdown, 1.8 V Version D,  
 $V_{IN} = 2.8 \text{ V}$

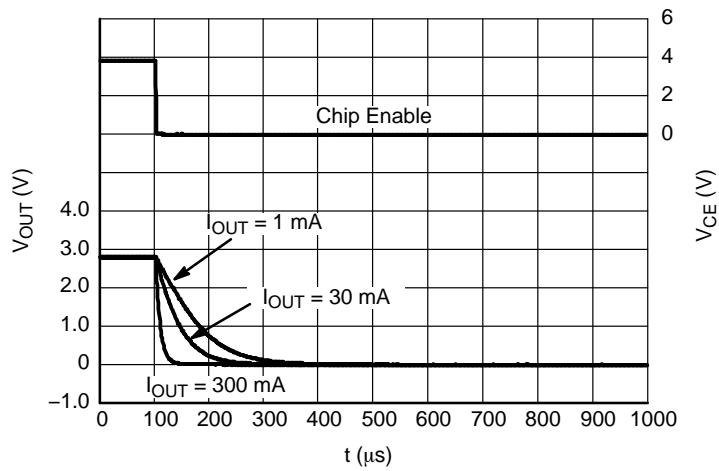

Figure 57. Shutdown, 2.8 V Version D,  
 $V_{IN} = 3.8 \text{ V}$



TYPICAL CHARACTERISTICS

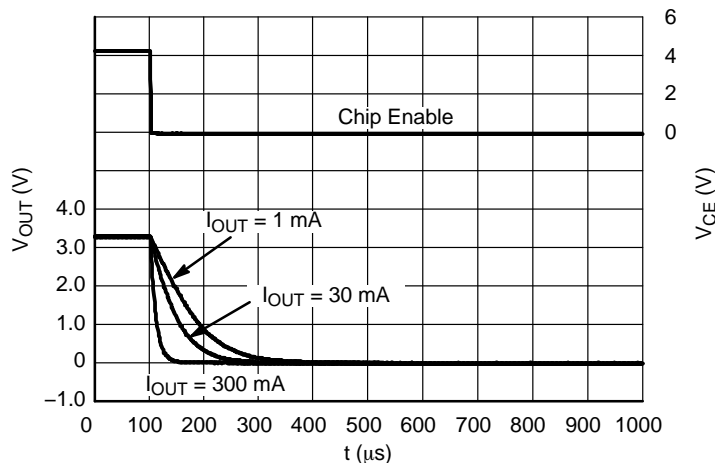

Figure 58. Shutdown, 3.3 V Version D, V<sub>IN</sub> = 4.3 V

APPLICATION INFORMATION

A typical application circuit for NCP4683 series is shown in Figure 59.

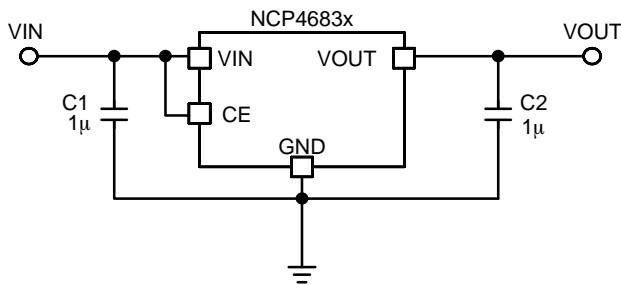

Figure 59. Typical Application Schematic

Input Decoupling Capacitor (C1)

A 1 μF ceramic input decoupling capacitor should be connected as close as possible to the input and ground pin of the NCP4683. Higher values and lower ESR improves line transient response.

Output Decoupling Capacitor (C2)

A 1 μF ceramic output decoupling capacitor is enough to achieve stable operation of the IC. If a tantalum capacitor is used, and its ESR is high, loop oscillation may result. The capacitors should be connected as close as possible to the output and ground pins. Larger values and lower ESR improves dynamic parameters.

Enable Operation

The enable pin CE may be used for turning the regulator on and off. The IC is switched on when a high level voltage is applied to the CE pin. The enable pin has an internal pull

down current source. If the enable function is not needed connect CE pin to VIN.

Current Limit

This regulator includes fold-back type current limit circuit. This type of protection doesn't limit current up to current capability in normal operation, but when over current occurs, output voltage and current decrease until over current condition ends. Typical characteristics of this protection type can be observed in the Output Voltage vs. Output Current graphs shown in the typical characteristics chapter of this datasheet.

Output Discharger

The D version includes a transistor between VOUT and GND that is used for faster discharging of the output capacitor. This function is activated when the IC goes into disable mode.

Thermal

As power across the IC increase, it might become necessary to provide some thermal relief. The maximum power dissipation supported by the device is dependent upon board design and layout. Mounting pad configuration on the PCB, the board material, and also the ambient temperature affect the rate of temperature increase for the part. When the device has good thermal conductivity through the PCB the junction temperature will be relatively low in high power dissipation applications.

PCB layout

Make the VIN and GND line as large as practical. If their impedance is high, noise pickup or unstable operation may result. Connect capacitors C1 and C2 as close as possible to the IC, and make wiring as short as possible.

# NCP4683

## ORDERING INFORMATION

| Device           | Nominal Output Voltage | Description    | Marking | Package            | Shipping†           |
|------------------|------------------------|----------------|---------|--------------------|---------------------|
| NCP4683DMU09TCG  | 0.9                    | Auto discharge | Q1      | UDFN4<br>(Pb-Free) | 10000 / Tape & Reel |
| NCP4683DMU12TCG  | 1.20                   | Auto discharge | Q4      |                    |                     |
| NCP4683DMU18TCG  | 1.80                   | Auto discharge | R0      |                    |                     |
| NCP4683DMU185TCG | 1.85                   | Auto discharge | T0      |                    |                     |
| NCP4683DMU285TCG | 2.85                   | Auto discharge | T1      |                    |                     |
| NCP4683DMU31TCG  | 3.1                    | Auto discharge | S3      |                    |                     |
| NCP4683DMU31TCG  | 3.1                    | Auto discharge | S3      |                    |                     |
| NCP4683HMU12TCG  | 1.20                   | Standard       | L4      | SC-70<br>(Pb-Free) | 3000 / Tape & Reel  |
| NCP4683HMU185TCG | 1.85                   | Standard       | P0      |                    |                     |
| NCP4683DSQ18T1G  | 1.80                   | Auto discharge | AH18    |                    |                     |
| NCP4683DSQ28T1G  | 2.80                   | Auto discharge | AH28    |                    |                     |
| NCP4683DSQ33T1G  | 3.30                   | Auto discharge | AH33    |                    |                     |

†For information on tape and reel specifications, including part orientation and tape sizes, please refer to our Tape and Reel Packaging Specifications Brochure, BRD8011/D.

\*Marking codes for XDFN0808 packages are unified.

\*\*To order other package and voltage variants, please contact your ON Semiconductor sales representative.

# MECHANICAL CASE OUTLINE PACKAGE DIMENSIONS



SCALE 2:1

## SC-88A (SC-70-5/SOT-353) CASE 419A-02 ISSUE M

DATE 11 APR 2023

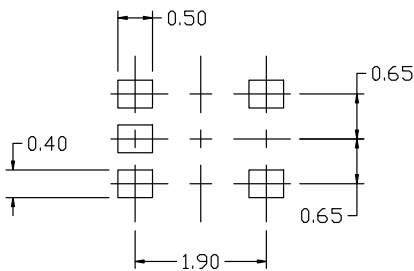
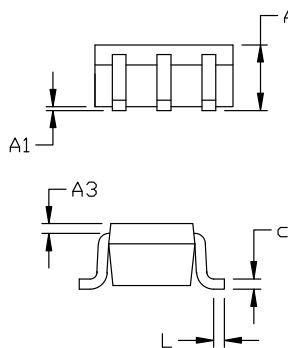

RECOMMENDED  
MOUNTING FOOTPRINT

\* For additional information on our Pb-Free strategy and soldering details, please download the ON Semiconductor Soldering and Mounting Techniques Reference Manual, SOLDERM/D.

### NOTES:

1. DIMENSIONING AND TOLERANCING PER ANSI Y14.5M, 1982.
2. CONTROLLING DIMENSION: MILLIMETERS
3. 419A-01 OBSOLETE. NEW STANDARD 419A-02
4. DIMENSIONS D AND E1 DO NOT INCLUDE MOLD FLASH, PROTRUSIONS, OR GATE BURRS. MOLD FLASH, PROTRUSIONS, OR GATE BURRS SHALL NOT EXCEED 0.1016MM PER SIDE.

| DIM | MILLIMETERS |      |      |
|-----|-------------|------|------|
|     | MIN.        | NOM. | MAX. |
| A   | 0.80        | 0.95 | 1.10 |
| A1  | ---         | ---  | 0.10 |
| A3  | 0.20 REF    |      |      |
| b   | 0.10        | 0.20 | 0.30 |
| c   | 0.10        | ---  | 0.25 |
| D   | 1.80        | 2.00 | 2.20 |
| E   | 2.00        | 2.10 | 2.20 |
| E1  | 1.15        | 1.25 | 1.35 |
| e   | 0.65 BSC    |      |      |
| L   | 0.10        | 0.15 | 0.30 |

### GENERIC MARKING DIAGRAM\*

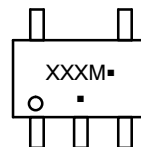

\*This information is generic. Please refer to device data sheet for actual part marking. Pb-Free indicator, "G" or microdot "▪", may or may not be present. Some products may not follow the Generic Marking.

XXX = Specific Device Code

M = Date Code

▪ = Pb-Free Package

(Note: Microdot may be in either location)

#### STYLE 1:

1. BASE
2. EMITTER
3. BASE
4. COLLECTOR
5. COLLECTOR

#### STYLE 2:

1. ANODE
2. EMITTER
3. BASE
4. COLLECTOR
5. CATHODE

#### STYLE 3:

1. ANODE 1
2. N/C
3. ANODE 2
4. CATHODE 2
5. CATHODE 1

#### STYLE 4:

1. SOURCE 1
2. DRAIN 1/2
3. SOURCE 1
4. GATE 1
5. GATE 2

#### STYLE 5:

1. CATHODE
2. COMMON ANODE
3. CATHODE 2
4. CATHODE 3
5. CATHODE 4

#### STYLE 6:

1. EMITTER 2
2. BASE 2
3. EMITTER 1
4. COLLECTOR
5. COLLECTOR 2/BASE 1

#### STYLE 7:

1. BASE
2. EMITTER
3. BASE
4. COLLECTOR
5. COLLECTOR

#### STYLE 8:

1. CATHODE
2. COLLECTOR
3. N/C
4. BASE
5. EMITTER

#### STYLE 9:

1. ANODE
2. CATHODE
3. ANODE
4. ANODE
5. ANODE

Note: Please refer to datasheet for style callout. If style type is not called out in the datasheet refer to the device datasheet pinout or pin assignment.

|                         |                                 |   |
|-------------------------|---------------------------------|---|
| <b>DOCUMENT NUMBER:</b> | <b>98ASB42984B</b>              | Electronic versions are uncontrolled except when accessed directly from the Document Repository.<br>Printed versions are uncontrolled except when stamped "CONTROLLED COPY" in red. |
| <b>DESCRIPTION:</b>     | <b>SC-88A (SC-70-5/SOT-353)</b> | <b>PAGE 1 OF 1</b>  |

onsemi and ONSEMI are trademarks of Semiconductor Components Industries, LLC dba onsemi or its subsidiaries in the United States and/or other countries. onsemi reserves the right to make changes without further notice to any products herein. onsemi makes no warranty, representation or guarantee regarding the suitability of its products for any particular purpose, nor does onsemi assume any liability arising out of the application or use of any product or circuit, and specifically disclaims any and all liability, including without limitation special, consequential or incidental damages. onsemi does not convey any license under its patent rights nor the rights of others.

# MECHANICAL CASE OUTLINE PACKAGE DIMENSIONS

ON Semiconductor®



SCALE 4:1

UDFN4 1.0x1.0, 0.65P  
CASE 517BR-01  
ISSUE O

DATE 27 OCT 2010

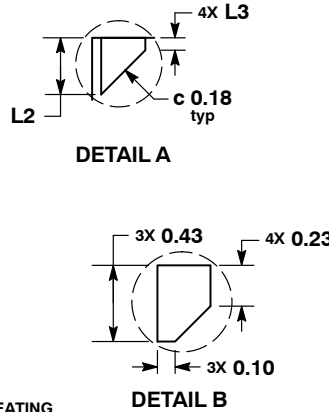
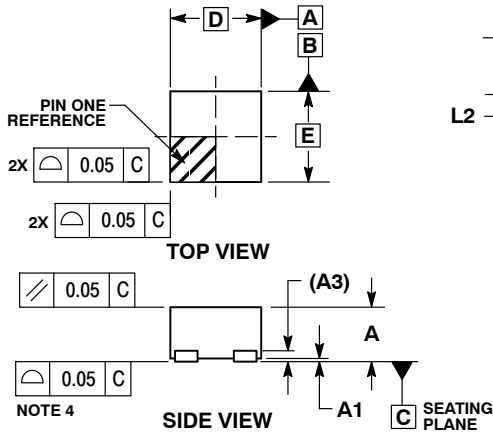

**NOTES:**

1. DIMENSIONING AND TOLERANCING PER ASME Y14.5M, 1994.
2. CONTROLLING DIMENSION: MILLIMETERS.
3. DIMENSION b APPLIES TO PLATED TERMINAL AND IS MEASURED BETWEEN 0.15 AND 0.20 mm FROM TERMINAL.
4. COPLANARITY APPLIES TO THE EXPOSED PAD AS WELL AS THE TERMINALS.

| MILLIMETERS |      |      |
|-------------|------|------|
| DIM         | MIN  | MAX  |
| A           | ---  | 0.60 |
| A1          | 0.00 | 0.05 |
| A3          | 0.10 | REF  |
| b           | 0.20 | 0.30 |
| D           | 1.00 | BSC  |
| D2          | 0.43 | 0.53 |
| E           | 1.00 | BSC  |
| e           | 0.65 | BSC  |
| L           | 0.20 | 0.30 |
| L2          | 0.27 | 0.37 |
| L3          | 0.02 | 0.12 |

**GENERIC MARKING DIAGRAM\***

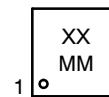

XX = Specific Device Code  
MM = Date Code

\*This information is generic. Please refer to device data sheet for actual part marking.  
Pb-Free indicator, "G" or microdot "▪", may or may not be present.

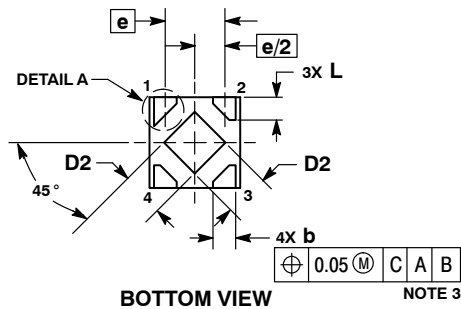

**RECOMMENDED MOUNTING FOOTPRINT\***

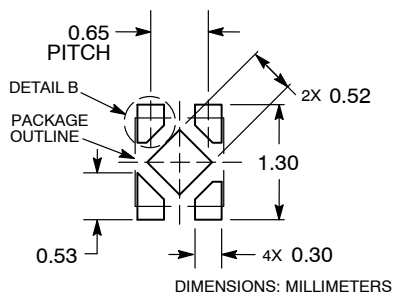

\*For additional information on our Pb-Free strategy and soldering details, please download the ON Semiconductor Soldering and Mounting Techniques Reference Manual, SOLDERRM/D.

|                         |                              |  |
|-------------------------|------------------------------|--|
| <b>DOCUMENT NUMBER:</b> | <b>98AON53254E</b>           | Electronic versions are uncontrolled except when accessed directly from the Document Repository. Printed versions are uncontrolled except when stamped "CONTROLLED COPY" in red. |
| <b>DESCRIPTION:</b>     | <b>UDFN4, 1.0X1.0, 0.65P</b> | <b>PAGE 1 OF 1</b>   |

ON Semiconductor and are trademarks of Semiconductor Components Industries, LLC dba ON Semiconductor or its subsidiaries in the United States and/or other countries. ON Semiconductor reserves the right to make changes without further notice to any products herein. ON Semiconductor makes no warranty, representation or guarantee regarding the suitability of its products for any particular purpose, nor does ON Semiconductor assume any liability arising out of the application or use of any product or circuit, and specifically disclaims any and all liability, including without limitation special, consequential or incidental damages. ON Semiconductor does not convey any license under its patent rights nor the rights of others.

**onsemi**, **Onsemi**, and other names, marks, and brands are registered and/or common law trademarks of Semiconductor Components Industries, LLC dba "**onsemi**" or its affiliates and/or subsidiaries in the United States and/or other countries. **onsemi** owns the rights to a number of patents, trademarks, copyrights, trade secrets, and other intellectual property. A listing of **onsemi**'s product/patent coverage may be accessed at [www.onsemi.com/site/pdf/Patent-Marking.pdf](http://www.onsemi.com/site/pdf/Patent-Marking.pdf). **onsemi** reserves the right to make changes at any time to any products or information herein, without notice. The information herein is provided "as-is" and **onsemi** makes no warranty, representation or guarantee regarding the accuracy of the information, product features, availability, functionality, or suitability of its products for any particular purpose, nor does **onsemi** assume any liability arising out of the application or use of any product or circuit, and specifically disclaims any and all liability, including without limitation special, consequential or incidental damages. Buyer is responsible for its products and applications using **onsemi** products, including compliance with all laws, regulations and safety requirements or standards, regardless of any support or applications information provided by **onsemi**. "Typical" parameters which may be provided in **onsemi** data sheets and/or specifications can and do vary in different applications and actual performance may vary over time. All operating parameters, including "Typicals" must be validated for each customer application by customer's technical experts. **onsemi** does not convey any license under any of its intellectual property rights nor the rights of others. **onsemi** products are not designed, intended, or authorized for use as a critical component in life support systems or any FDA Class 3 medical devices or medical devices with a same or similar classification in a foreign jurisdiction or any devices intended for implantation in the human body. Should Buyer purchase or use **onsemi** products for any such unintended or unauthorized application, Buyer shall indemnify and hold **onsemi** and its officers, employees, subsidiaries, affiliates, and distributors harmless against all claims, costs, damages, and expenses, and reasonable attorney fees arising out of, directly or indirectly, any claim of personal injury or death associated with such unintended or unauthorized use, even if such claim alleges that **onsemi** was negligent regarding the design or manufacture of the part. **onsemi** is an Equal Opportunity/Affirmative Action Employer. This literature is subject to all applicable copyright laws and is not for resale in any manner.

## ADDITIONAL INFORMATION

### TECHNICAL PUBLICATIONS:

Technical Library: [www.onsemi.com/design/resources/technical-documentation](http://www.onsemi.com/design/resources/technical-documentation)  
onsemi Website: [www.onsemi.com](http://www.onsemi.com)

### ONLINE SUPPORT: [www.onsemi.com/support](http://www.onsemi.com/support)

For additional information, please contact your local Sales Representative at [www.onsemi.com/support/sales](http://www.onsemi.com/support/sales)