

NCP4681, NCP4684

150 mA, Ultra Low Quiescent Current, Low Dropout Regulator

The NCP4681 and NCP4684 are CMOS Linear voltage regulators with 150 mA output current capability and ultra low supply currents (1 μ A typ.) The devices are easy to use and include output current protection and a fully integrated soft-start circuit to minimize inrush current and to ensure no output voltage overshoot. The NCP4681 includes an Enable function to reduce supply current by using a Standby mode, while the NCP4684 excludes the Enable pin to avoid any pull down current, thereby offering the lowest possible current consumption for battery powered applications in Active mode. For portable products the devices are available in the exceptionally small 0.8 x 0.8 mm XDFN, along with the SC-70 and SOT23 packages

Features

- Operating Input Voltage Range: 1.40 V to 5.25 V
- Output Voltage Range: 0.8 V to 3.6 V (available in 0.1 V steps)
- Output Voltage Accuracy: $\pm 1.0\%$
- Supply Current: 1 μ A (excluding the CE pull down current)
- Dropout Voltage: 0.28 V ($I_{OUT} = 150$ mA, $V_{OUT} = 2.8$ V)
- Line Regulation: 0.02%/V Typ.
- Stable with Ceramic Capacitors: 0.1 μ F or more
- Current Fold Back Protection
- Build-in Constant Slope Circuit for soft-start function
- Available in XDFN4 0.8 x 0.8 mm, SC-70, SOT23 Packages
- These are Pb-Free Devices

Typical Applications

- Battery-powered Equipment
- Networking and Communication Equipment
- Cameras, DVRs, STB and Camcorders
- Home Appliances

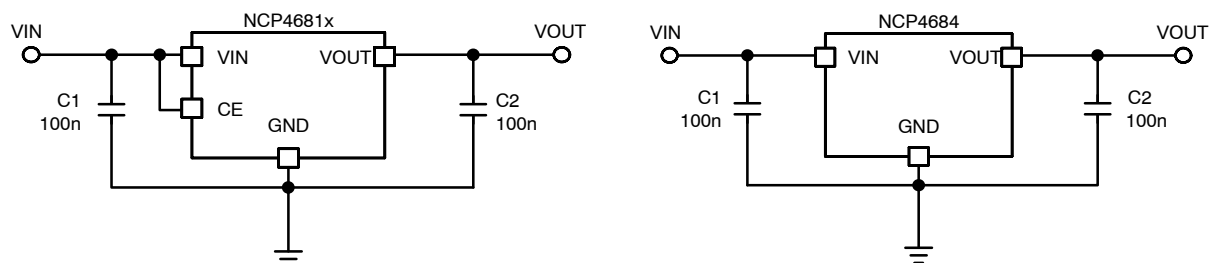

Figure 1. Typical Application Schematics



ON Semiconductor®

<http://onsemi.com>

MARKING DIAGRAMS



SC-70
CASE 419A

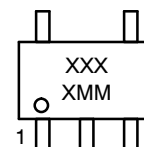

SOT-23-5
CASE 1212

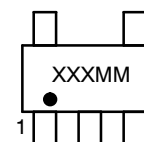

XDFN4
CASE 711AB

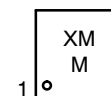

X, XXXX = Specific Device Code
MM = Date Code

ORDERING INFORMATION

See detailed ordering and shipping information in the package dimensions section on page 15 of this data sheet.

NCP4681, NCP4684

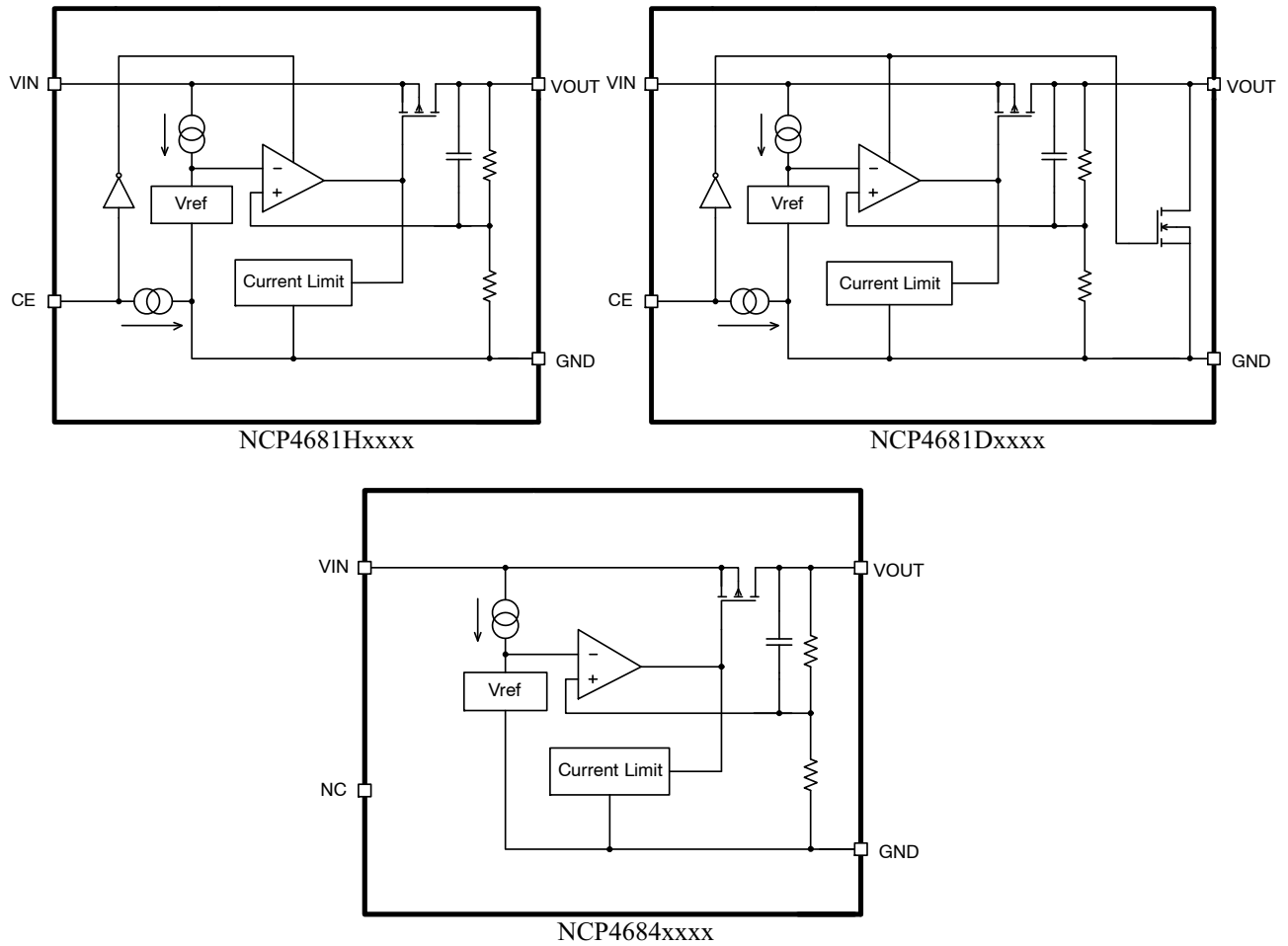

Figure 2. Simplified Schematic Block Diagram

PIN FUNCTION DESCRIPTION

Pin No. XDFN0808*	Pin No. SC-70	Pin No. SOT23	Pin Name	Description
1	4	5	V _{OUT}	Output pin
2	3	2	GND	Ground
3	1	3	CE/NC	Chip enable pin (Active "H") / No connection (NCP4684)
4	5	1	V _{IN}	Input pin
-	2	4	NC	No connection

*Tab is GND level. (They are connected to the reverse side of this IC.
The tab is better to be connected to the GND, but leaving it open is also acceptable.

NCP4681, NCP4684

ABSOLUTE MAXIMUM RATINGS

Rating	Symbol	Value	Unit
Input Voltage (Note 1)	V_{IN}	6.0	V
Output Voltage	V_{OUT}	-0.3 to $V_{IN} + 0.3$	V
Chip Enable Input	V_{CE}	6.0	V
Output Current	I_{OUT}	180	mA
Power Dissipation XDFN0808	P_D	286	mW
Power Dissipation SC-70		380	
Power Dissipation SOT23		420	
Junction Temperature	T_J	-40 to 150	°C
Storage Temperature	T_{STG}	-55 to 125	°C
ESD Capability, Human Body Model (Note 2)	ESD_{HBM}	2000	V
ESD Capability, Machine Model (Note 2)	ESD_{MM}	200	V

Stresses exceeding Maximum Ratings may damage the device. Maximum Ratings are stress ratings only. Functional operation above the Recommended Operating Conditions is not implied. Extended exposure to stresses above the Recommended Operating Conditions may affect device reliability.

1. Refer to ELECTRICAL CHARACTERISTICS and APPLICATION INFORMATION for Safe Operating Area.
2. This device series incorporates ESD protection and is tested by the following methods:
 ESD Human Body Model tested per AEC-Q100-002 (EIA/JESD22-A114)
 ESD Machine Model tested per AEC-Q100-003 (EIA/JESD22-A115)
 Latch-up Current Maximum Rating tested per JEDEC standard: JESD78.

THERMAL CHARACTERISTICS

Rating	Symbol	Value	Unit
Thermal Characteristics, XDFN 0.8 x 0.8 mm Thermal Resistance, Junction-to-Air	$R_{\theta JA}$	350	°C/W
Thermal Characteristics, SOT23 Thermal Resistance, Junction-to-Air	$R_{\theta JA}$	238	°C/W
Thermal Characteristics, SC-70 Thermal Resistance, Junction-to-Air	$R_{\theta JA}$	263	°C/W

NCP4681, NCP4684

ELECTRICAL CHARACTERISTICS

$-40^{\circ}\text{C} \leq T_A \leq 85^{\circ}\text{C}$; $V_{IN} = V_{OUT(NOM)} + 1\text{ V}$ or 2.5 V , whichever is greater; $I_{OUT} = 1\text{ mA}$, $C_{IN} = C_{OUT} = 0.1\text{ }\mu\text{F}$, unless otherwise noted. Typical values are at $T_A = +25^{\circ}\text{C}$.

Parameter	Test Conditions		Symbol	Min	Typ	Max	Unit
Operating Input Voltage	(Note 3)		V_{IN}	1.40		5.25	V
Output Voltage	$T_A = +25^{\circ}\text{C}$	$V_{OUT} \geq 2.0\text{ V}$	V_{OUT}	x0.99		x1.01	V
		$V_{OUT} < 2.0\text{ V}$		-20		20	mV
	$-40^{\circ}\text{C} \leq T_A \leq 85^{\circ}\text{C}$	$V_{OUT} \geq 2.0\text{ V}$		x0.970		x1.025	V
		$V_{OUT} < 2.0\text{ V}$		-60		60	mV
Output Voltage Temp. Coefficient	$-40^{\circ}\text{C} \leq T_A \leq 85^{\circ}\text{C}$		$\Delta V_{OUT}/\Delta T_A$		± 100		ppm/ $^{\circ}\text{C}$
Line Regulation	$V_{OUT(NOM)} + 0.5\text{ V} \leq V_{IN} \leq 5.0\text{ V}$		Line_{Reg}		0.02	0.10	%/V
Load Regulation	$I_{OUT} = 1\text{ mA}$ to 150 mA		Load_{Reg}	-20	0	20	mV
Dropout Voltage	$I_{OUT} = 150\text{ mA}$	$0.8\text{ V} \leq V_{OUT} < 0.9\text{ V}$	V_{DO}		0.96	1.40	V
		$0.9\text{ V} \leq V_{OUT} < 1.0\text{ V}$			0.87	1.25	
		$1.0\text{ V} \leq V_{OUT} < 1.2\text{ V}$			0.78	1.15	
		$1.2\text{ V} \leq V_{OUT} < 1.4\text{ V}$			0.64	1.00	
		$1.4\text{ V} \leq V_{OUT} < 1.7\text{ V}$			0.52	0.80	
		$1.7\text{ V} \leq V_{OUT} < 2.0\text{ V}$			0.40	0.60	
		$2.0\text{ V} \leq V_{OUT} < 2.5\text{ V}$			0.32	0.48	
		$2.5\text{ V} \leq V_{OUT} < 3.0\text{ V}$			0.28	0.40	
		$3.0\text{ V} \leq V_{OUT} < 3.6\text{ V}$			0.25	0.35	
Output Current			I_{OUT}	150			mA
Short Current Limit	$V_{OUT} = 0\text{ V}$		I_{SC}		50		mA
Quiescent Current			I_Q		1	2	μA
Standby Current	$V_{CE} = 0\text{ V}$, $T_A = 25^{\circ}\text{C}$, NCP4681 only		I_{STB}		0.1	1.0	μA
CE Pin Threshold Voltage (NCP4681 only)	CE Input Voltage "H"		V_{CEH}	1.0			V
	CE Input Voltage "L"		V_{CEL}			0.4	
CE Pull Down Current	NCP4681 only		I_{CEPD}		0.3		μA
Power Supply Rejection Ratio	$V_{OUT} = 1.5\text{ V}$, $V_{IN} = 2.5\text{ V}$, $\Delta V_{IN} = 0.2\text{ V}_{pk-pk}$, $I_{OUT} = 30\text{ mA}$, $f = 1\text{ kHz}$		PSRR		25		dB
Output Noise Voltage	$f = 10\text{ Hz}$ to 100 kHz , $V_{OUT} = 1.5\text{ V}$, $V_{IN} = 2.5\text{ V}$, $I_{OUT} = 30\text{ mA}$		V_N		100		μV_{rms}
Low Output Nch Tr. On Resistance	$V_{IN} = 4\text{ V}$, $V_{CE} = 0\text{ V}$, NCP4681D only		R_{LOW}		60		Ω

3. The maximum Input Voltage of the Electrical Characteristics is 5.25 V. In case of exceeding this specification, the IC must be operated in condition that the Input Voltage is up to 5.50 V and total operation time is within 500 hours.

TYPICAL CHARACTERISTICS

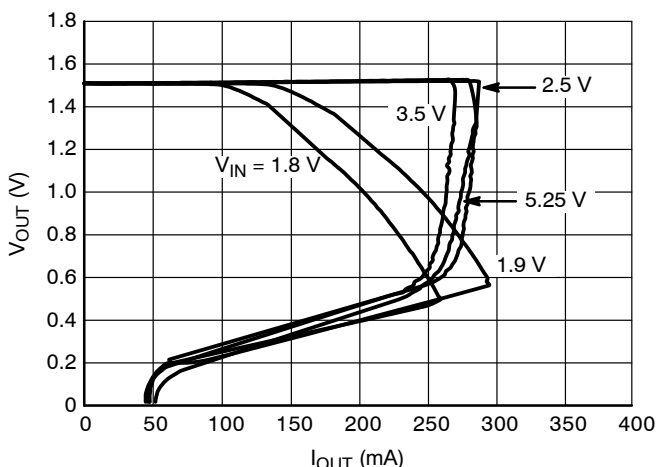

Figure 3. Output Voltage vs. Output Current
1.5 V Version ($T_J = 25^\circ\text{C}$)

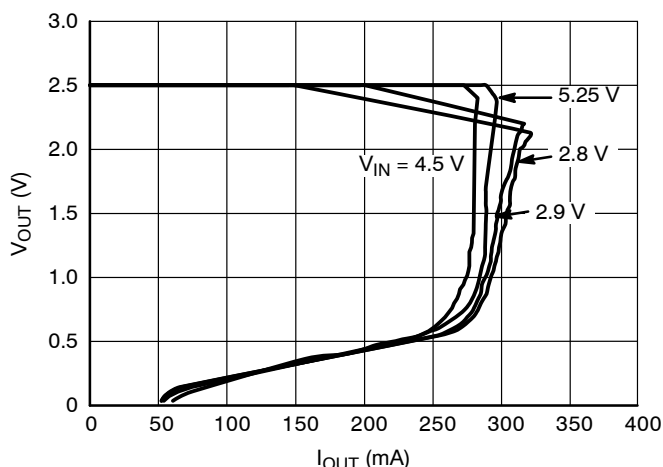

Figure 4. Output Voltage vs. Output Current
2.5 V Version ($T_J = 25^\circ\text{C}$)

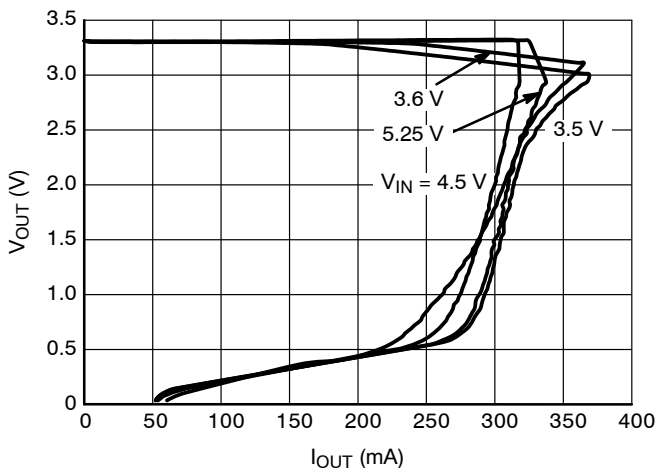

Figure 5. Output Voltage vs. Output Current
3.3 V Version ($T_J = 25^\circ\text{C}$)

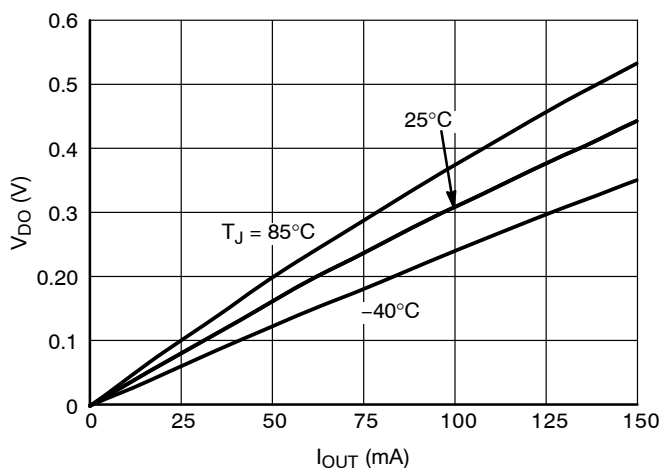

Figure 6. Dropout Voltage vs. Output Current
1.5 V Version

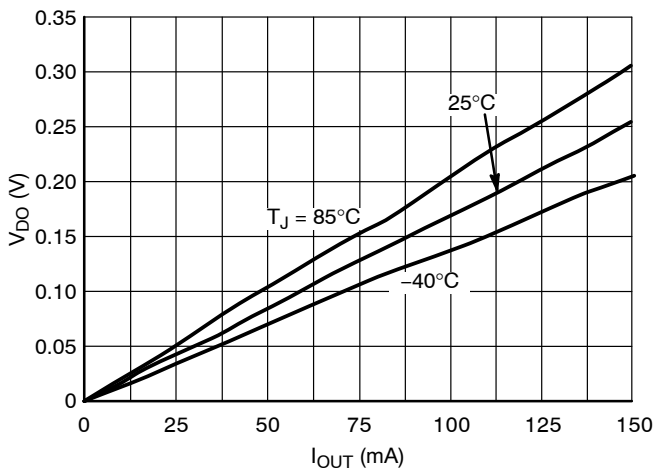

Figure 7. Dropout Voltage vs. Output Current
2.5 V Version

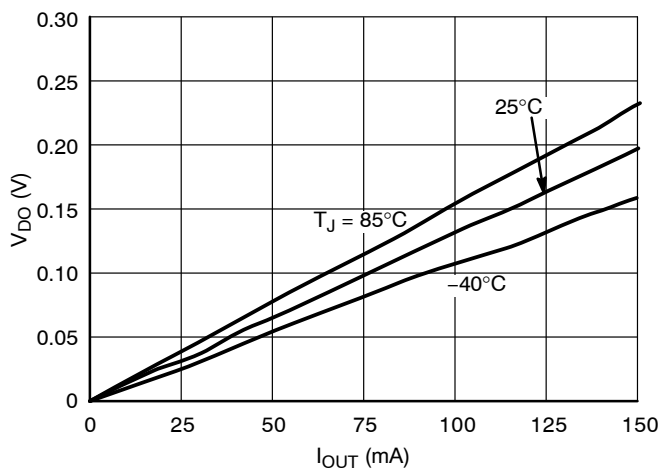

Figure 8. Dropout Voltage vs. Output Current
3.3 V Version

NCP4681, NCP4684

TYPICAL CHARACTERISTICS

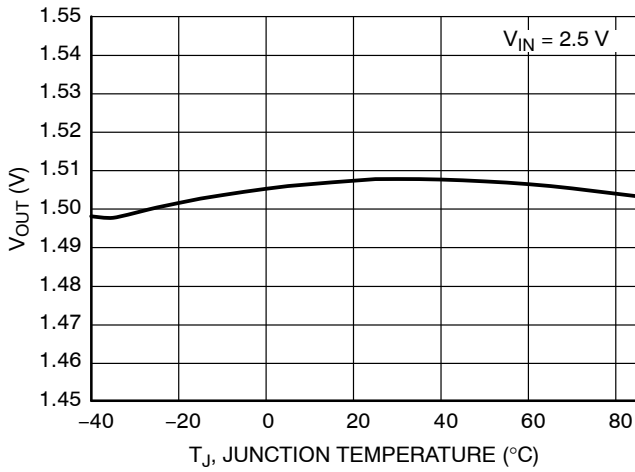

Figure 9. Output Voltage vs. Temperature, 1.5 V Version

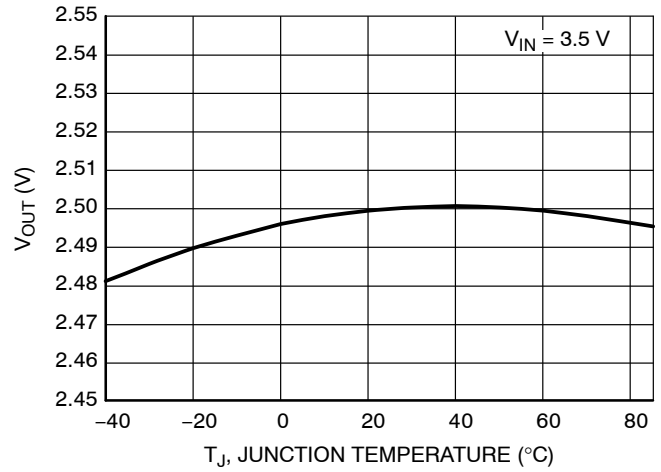

Figure 10. Output Voltage vs. Temperature, 2.5 V Version

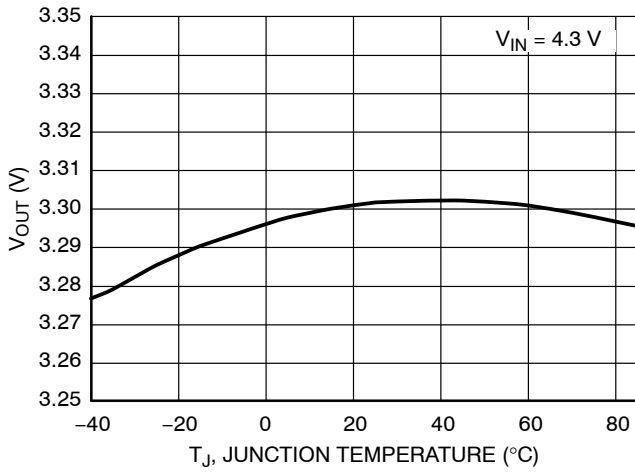

Figure 11. Output Voltage vs. Temperature, 3.3 V Version

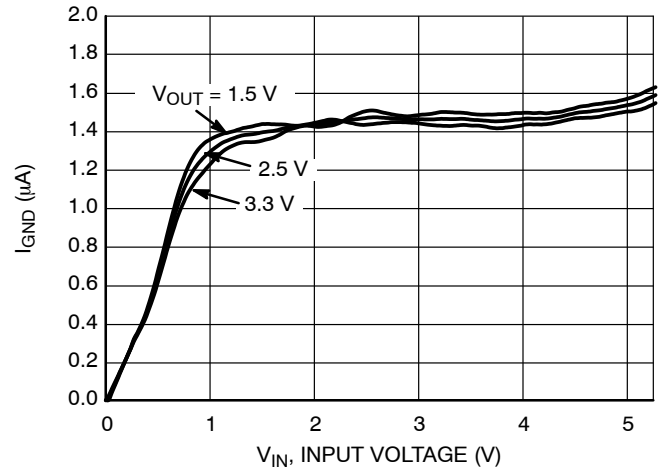

Figure 12. Supply Current vs. Input Voltage

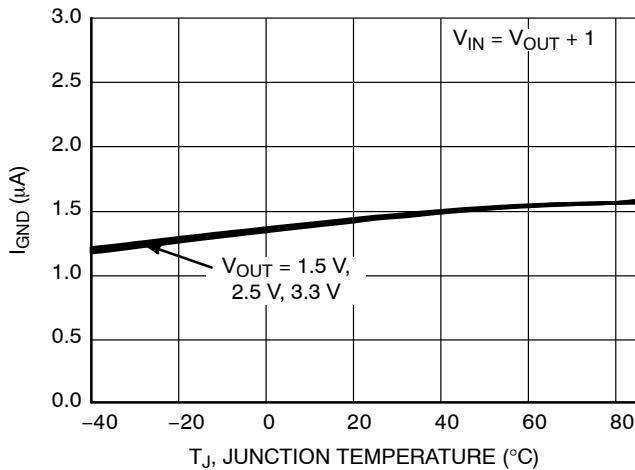

Figure 13. Supply Current vs. Temperature

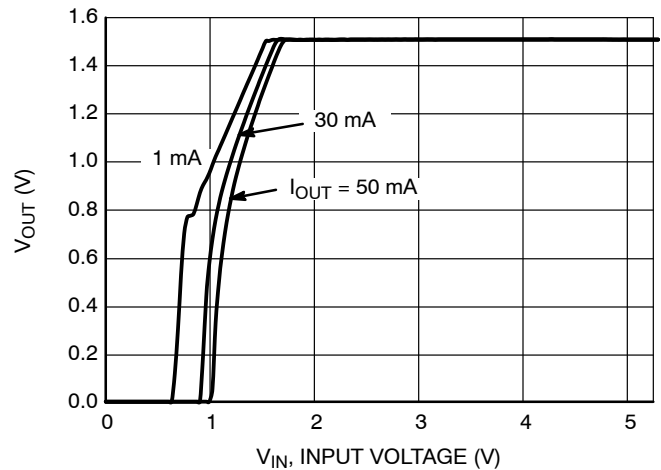

Figure 14. Output Voltage vs. Input Voltage, 1.5 V Version

NCP4681, NCP4684

TYPICAL CHARACTERISTICS

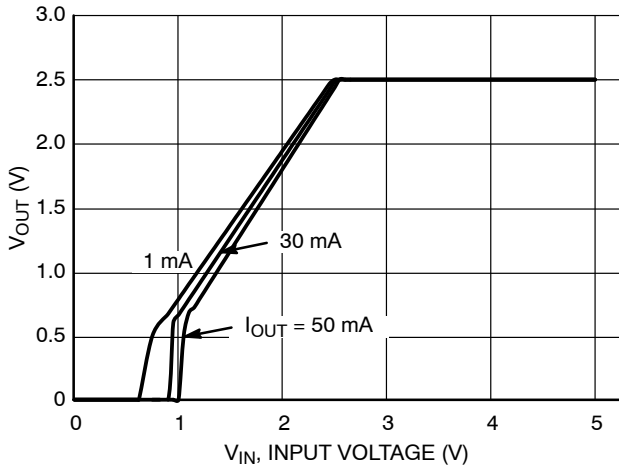

Figure 15. Output Voltage vs. Input Voltage, 2.5 V Version

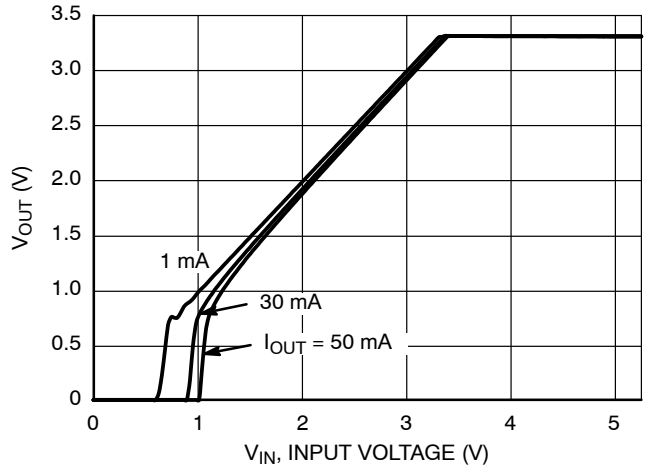

Figure 16. Output Voltage vs. Input Voltage, 3.3 V Version

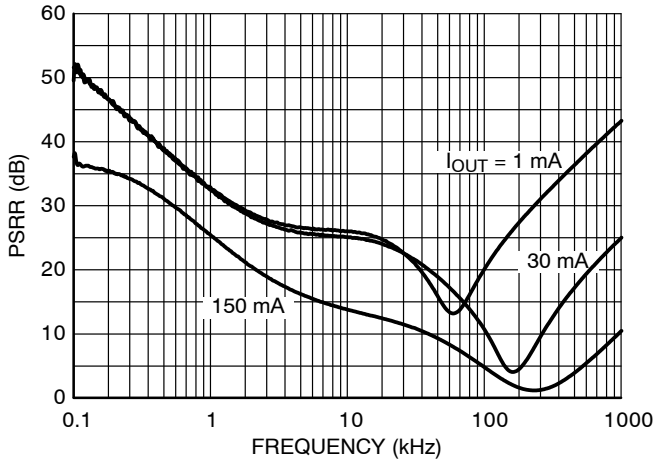

Figure 17. PSRR, 1.5 V Version, $V_{IN} = 2.5 V$

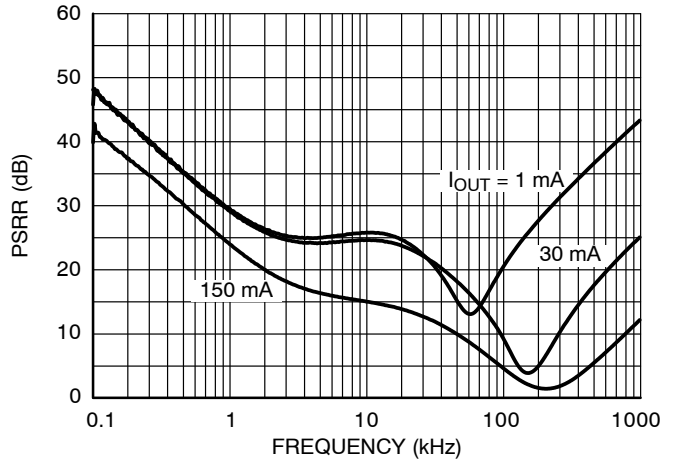

Figure 18. PSRR, 2.5 V Version, $V_{IN} = 3.5 V$

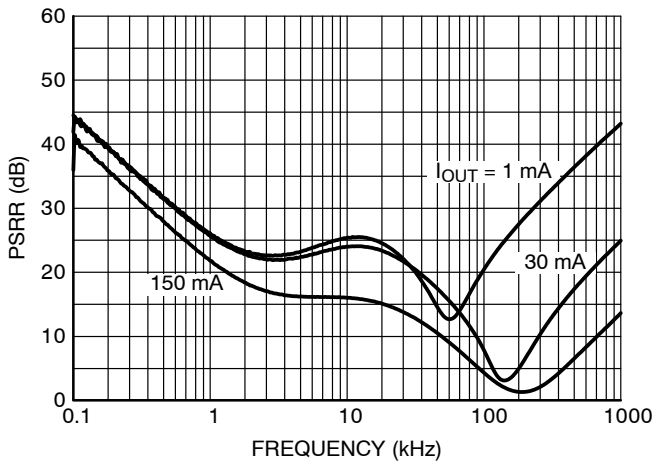

Figure 19. PSRR, 3.3 V Version, $V_{IN} = 4.3 V$

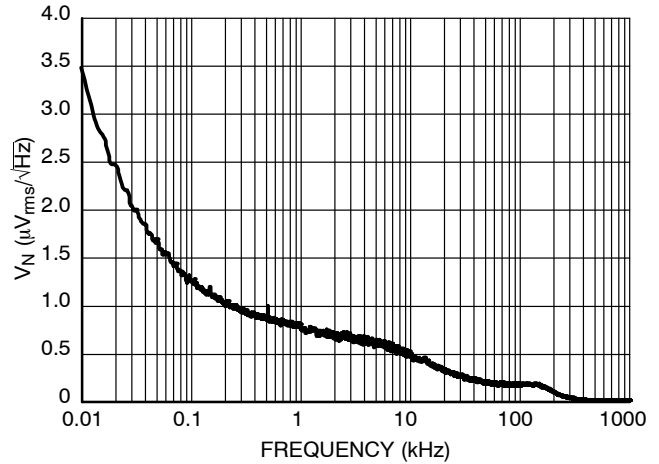

Figure 20. Output Voltage Noise, 1.5 V Version, $V_{IN} = 2.5 V$, $I_{OUT} = 30 mA$

NCP4681, NCP4684

TYPICAL CHARACTERISTICS

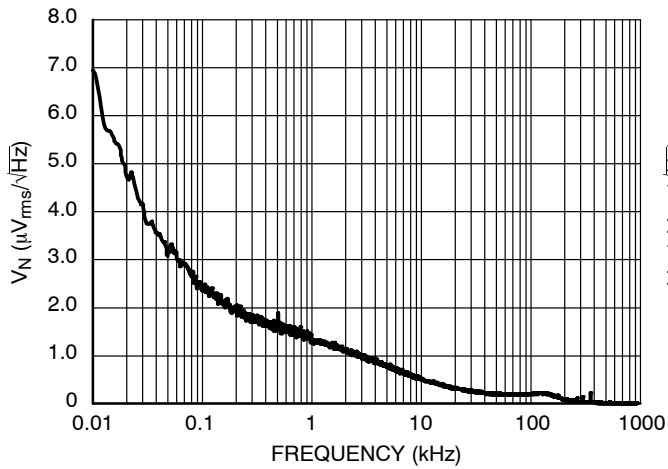

Figure 21. Output Voltage Noise, 2.5 V Version,
 $V_{\text{IN}} = 3.5 \text{ V}$, $I_{\text{OUT}} = 30 \text{ mA}$

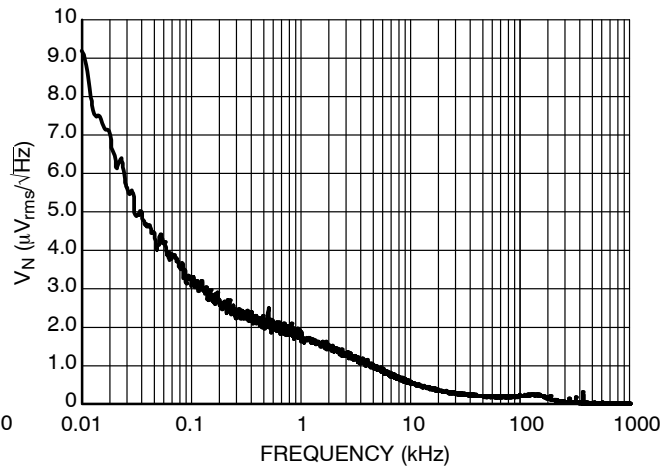

Figure 22. Output Voltage Noise, 3.3 V Version,
 $V_{\text{IN}} = 4.3 \text{ V}$, $I_{\text{OUT}} = 30 \text{ mA}$

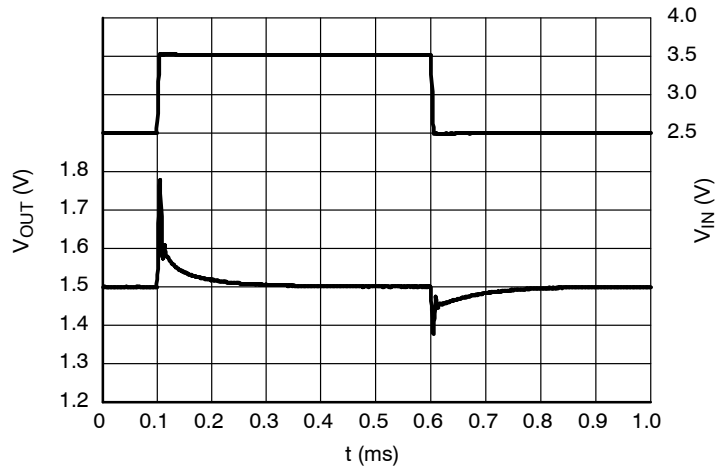

Figure 23. Line Transients, 1.5 V Version,
 $t_{\text{R}} = t_{\text{F}} = 5 \mu\text{s}$, $I_{\text{OUT}} = 30 \text{ mA}$

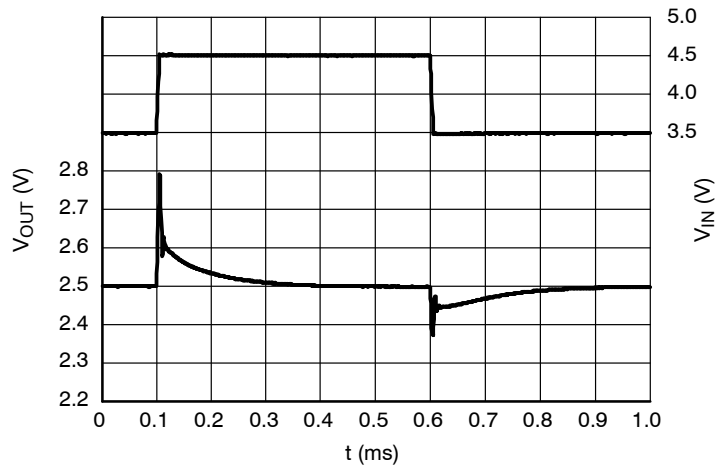
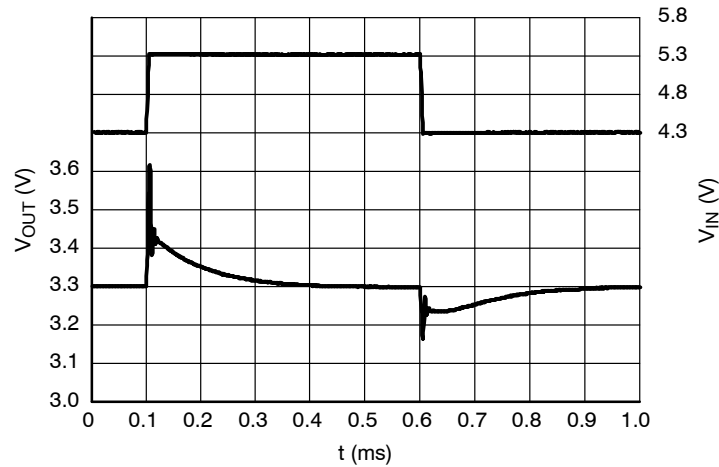

Figure 24. Line Transients, 2.5 V Version,
 $t_{\text{R}} = t_{\text{F}} = 5 \mu\text{s}$, $I_{\text{OUT}} = 30 \text{ mA}$

NCP4681, NCP4684

TYPICAL CHARACTERISTICS



**Figure 25. Line Transients, 3.3 V Version,
 $t_R = t_F = 5 \mu s$, $I_{OUT} = 30 \text{ mA}$**

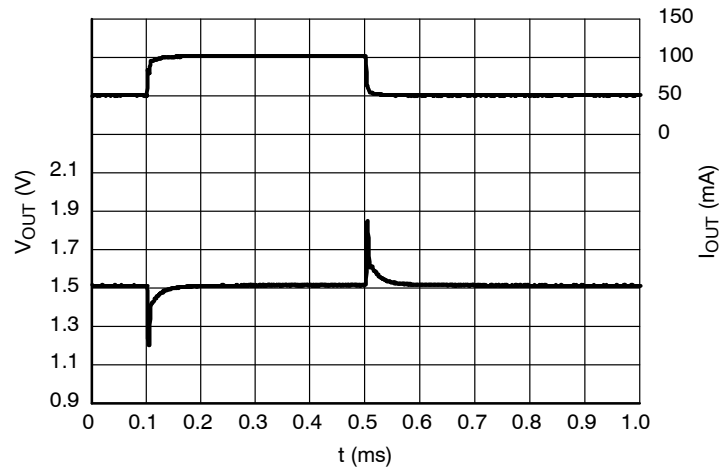

**Figure 26. Load Transients, 1.5 V Version,
 $I_{OUT} = 50 - 100 \text{ mA}$, $t_R = t_F = 0.5 \mu s$, $V_{IN} = 2.5 \text{ V}$**

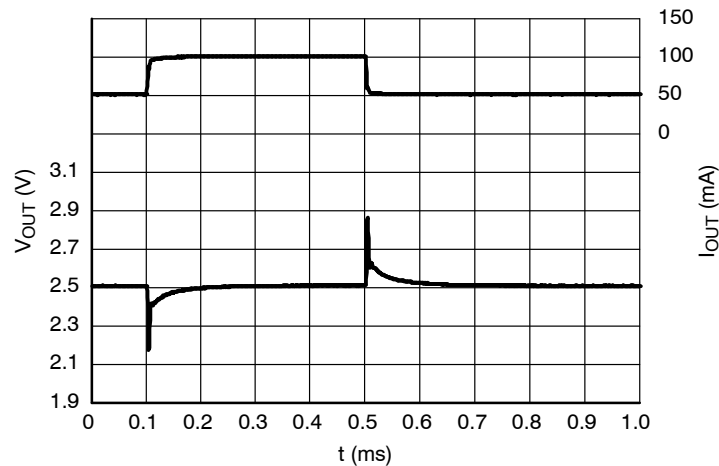

**Figure 27. Load Transients, 2.5 V Version,
 $I_{OUT} = 50 - 100 \text{ mA}$, $t_R = t_F = 0.5 \mu s$, $V_{IN} = 3.5 \text{ V}$**

NCP4681, NCP4684

TYPICAL CHARACTERISTICS

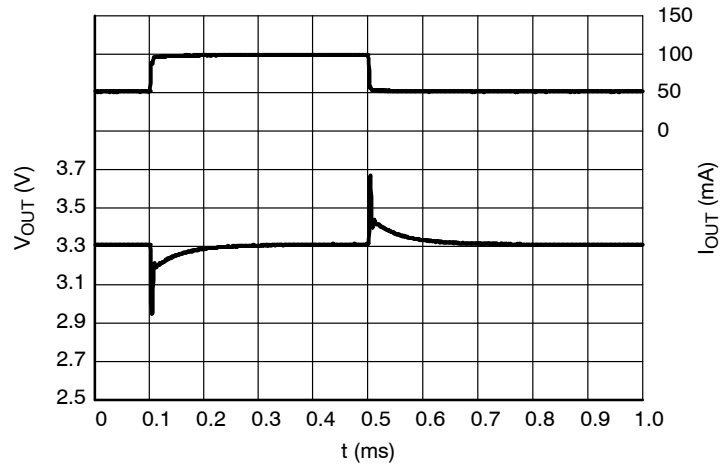

**Figure 28. Load Transients, 3.3 V Version,
 $I_{OUT} = 50 - 100 \text{ mA}$, $t_R = t_F = 0.5 \mu s$, $V_{IN} = 4.3 \text{ V}$**

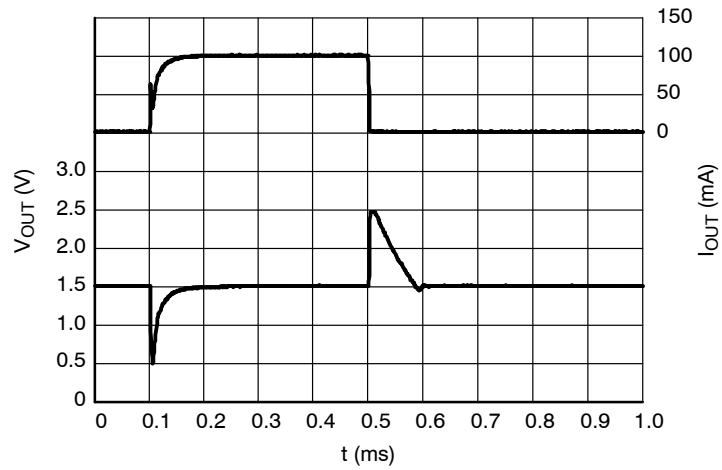

**Figure 29. Load Transients, 1.5 V Version,
 $I_{OUT} = 1 - 100 \text{ mA}$, $t_R = t_F = 0.5 \mu s$, $V_{IN} = 2.5 \text{ V}$**

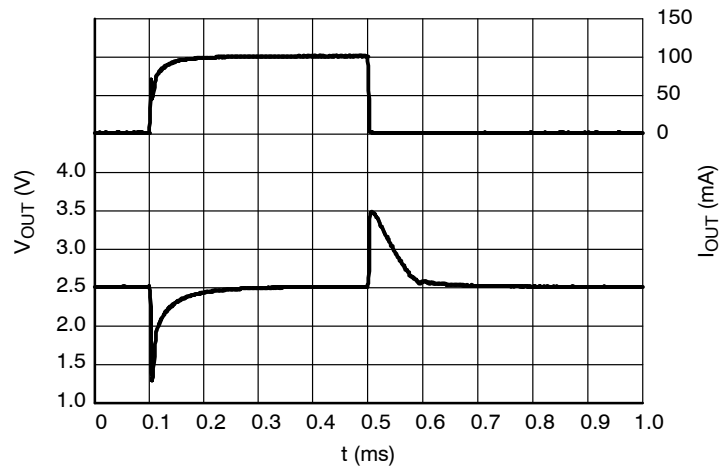

**Figure 30. Load Transients, 2.5 V Version,
 $I_{OUT} = 1 - 100 \text{ mA}$, $t_R = t_F = 0.5 \mu s$, $V_{IN} = 3.5 \text{ V}$**

NCP4681, NCP4684

TYPICAL CHARACTERISTICS

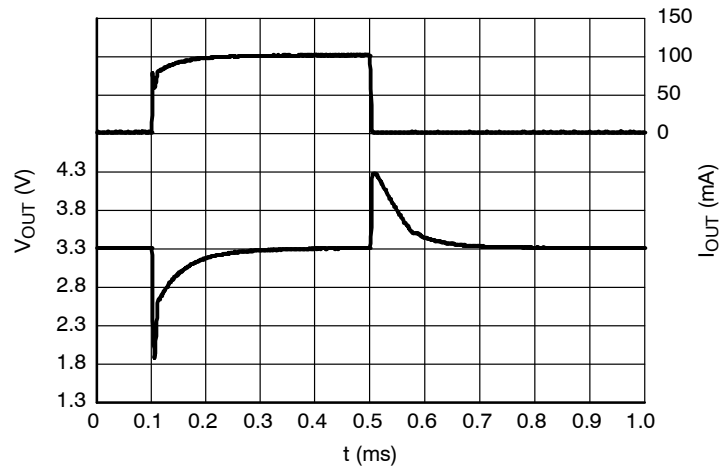

**Figure 31. Load Transients, 3.3 V Version,
I_{OUT} = 1 – 100 mA, t_R = t_F = 0.5 μs, V_{IN} = 4.3 V**

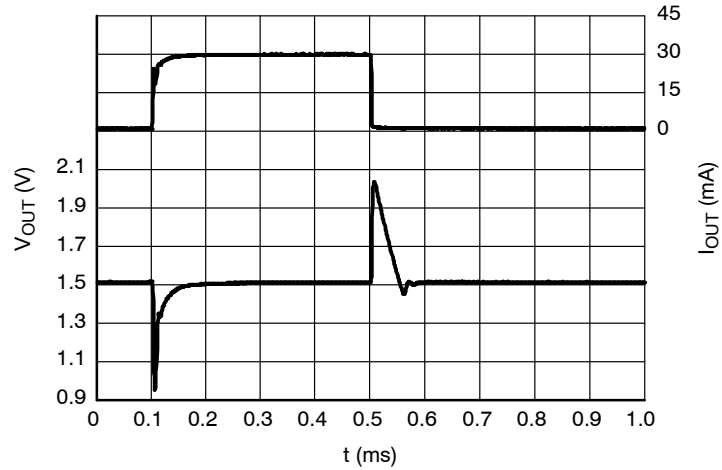

**Figure 32. Load Transients, 1.5 V Version,
I_{OUT} = 1 – 30 mA, t_R = t_F = 0.5 μs, V_{IN} = 2.5 V**

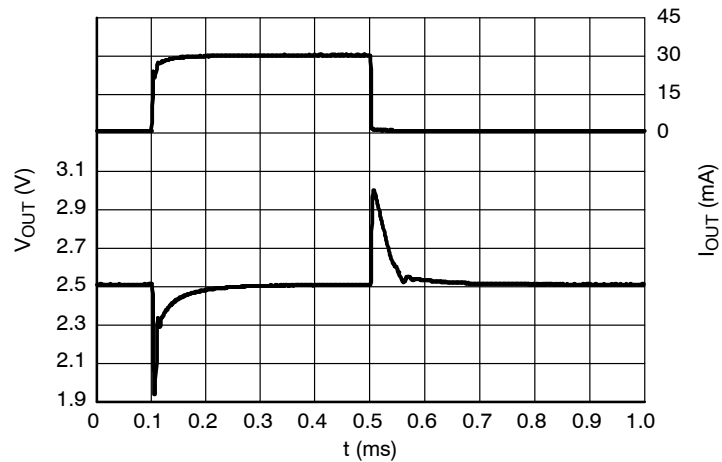

**Figure 33. Load Transients, 2.5 V Version,
I_{OUT} = 1 – 30 mA, t_R = t_F = 0.5 μs, V_{IN} = 2.5 V**

NCP4681, NCP4684

TYPICAL CHARACTERISTICS

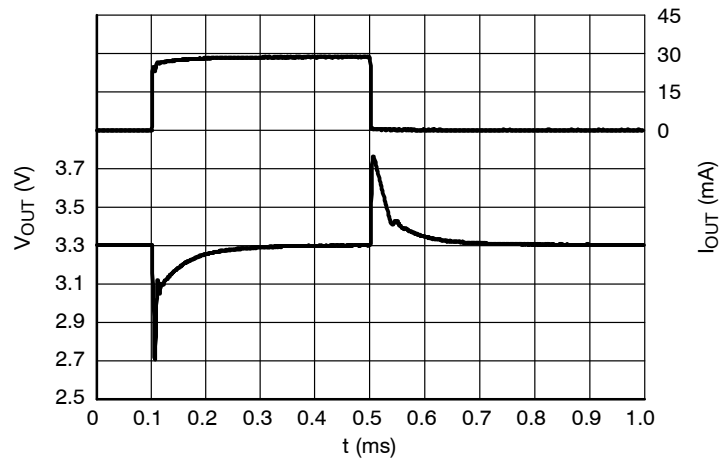

**Figure 34. Load Transients, 3.3 V Version,
 $I_{OUT} = 1 - 30 \text{ mA}$, $t_R = t_F = 0.5 \mu\text{s}$, $V_{IN} = 4.3 \text{ V}$**

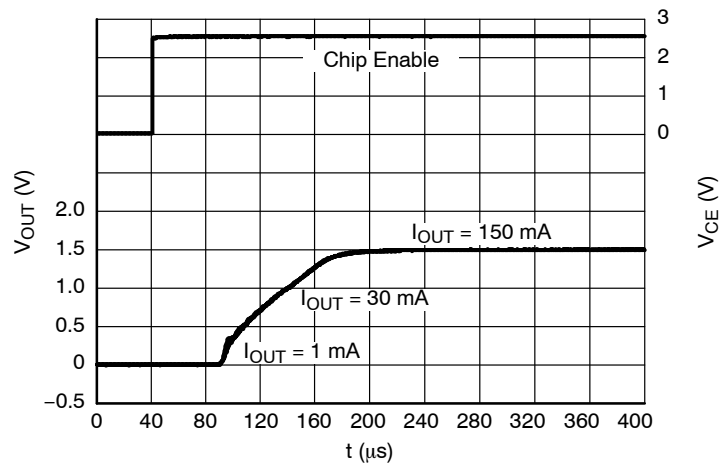

**Figure 35. Start-up, 1.5 V Version NCP4681x,
 $V_{IN} = 2.5 \text{ V}$**

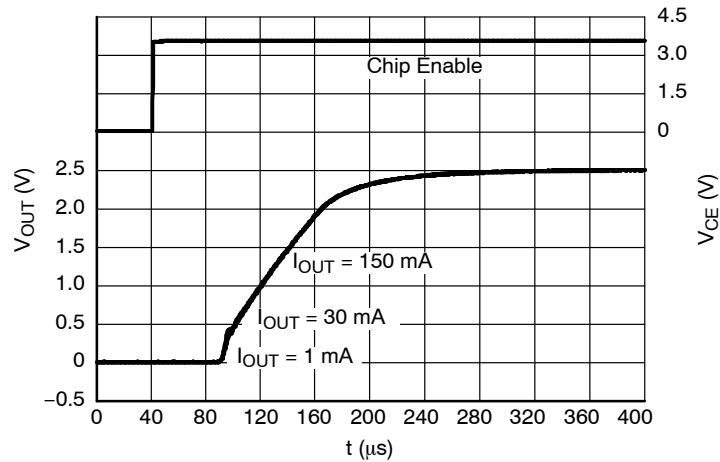

**Figure 36. Start-up, 2.5 V Version NCP4681x,
 $V_{IN} = 3.5 \text{ V}$**

NCP4681, NCP4684

TYPICAL CHARACTERISTICS

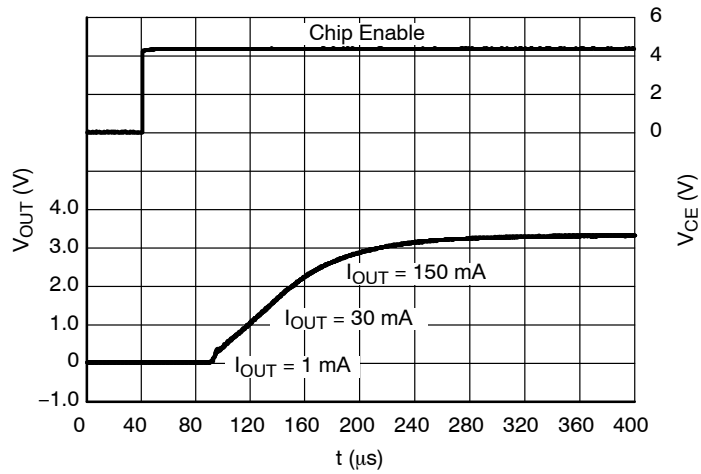

**Figure 37. Start-up, 3.3 V Version NCP4681x,
 $V_{IN} = 4.3 V$**

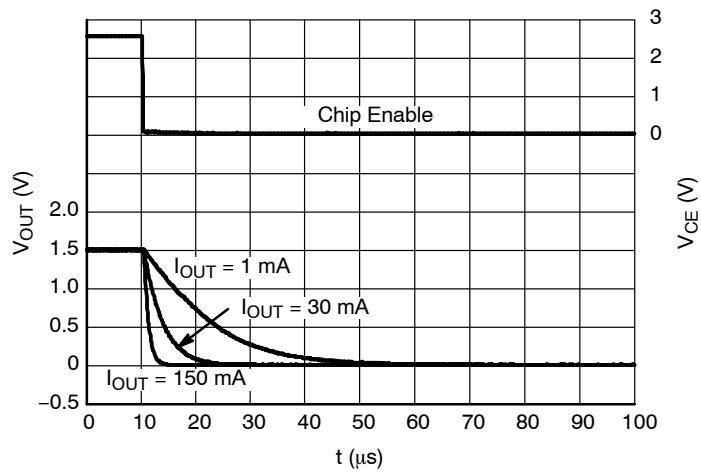

**Figure 38. Shutdown, 1.5 V Version NCP4681D,
 $V_{IN} = 2.5 V$**

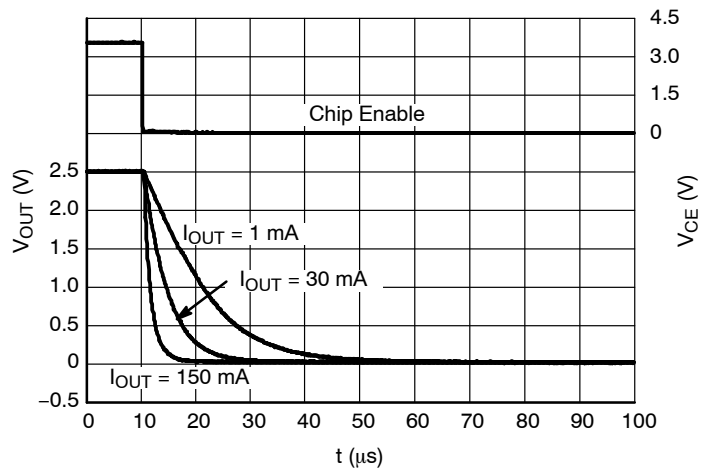

**Figure 39. Shutdown, 2.5 V version NCP4681D,
 $V_{IN} = 3.5 V$**

NCP4681, NCP4684

TYPICAL CHARACTERISTICS

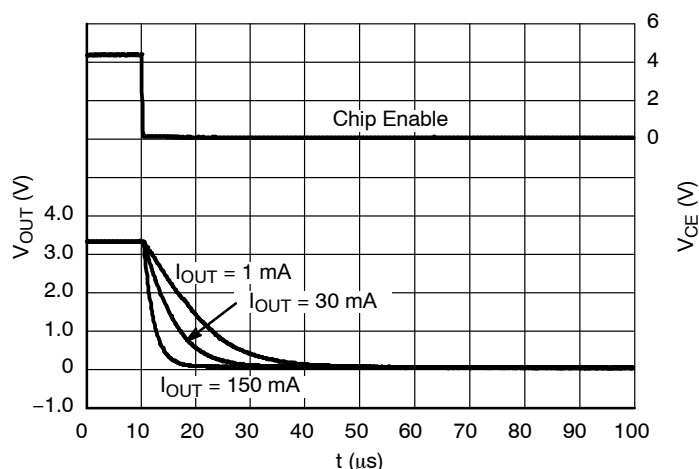

Figure 40. Shutdown, 3.3 V Version NCP4681D,
 $V_{IN} = 4.3 \text{ V}$

APPLICATION INFORMATION

A typical application circuits for NCP4681 and NCP4684 series are shown in Figure 41.

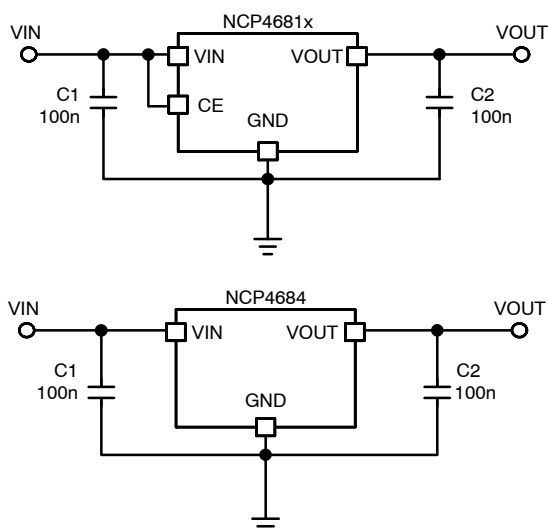

Figure 41. Typical Application Schematics

Input Decoupling Capacitor (C1)

A 0.1 μF ceramic input decoupling capacitor should be connected as close as possible to the input and ground pin of the NCP4681/4. Higher values and lower ESR improves line transient response.

Output Decoupling Capacitor (C2)

A 0.1 μF ceramic output decoupling capacitor is enough to achieve stable operation of the IC. If a tantalum capacitor is used, and its ESR is high, loop oscillation may result. The capacitors should be connected as close as possible to the

output and ground pins. Larger capacitor values and lower ESR improves dynamic parameters.

Enable Operation (NCP4681 Only)

The enable pin CE may be used for turning the regulator on and off. The IC is switched on when a high level voltage is applied to the CE pin. The enable pin has an internal pull down current source. If the enable function is not needed connect CE pin to VIN.

Constant Slope Circuit

The constant slope circuit is used as a soft start circuit that allows the output voltage to start up slowly with a defined slope. This circuit minimizes inrush current at start up and also prevents against overshoot of the output voltage. The Constant slope circuit is fully built in and no external components are needed. Start up time and the output voltage slope is defined internally and there is no way for the user to change it. Start up into bigger output capacitor doesn't make any problem due to cooperation of constant slope circuit and current limit circuit.

Current Limit

This regulator includes a fold-back current limiting circuit. This type of protection doesn't limit output current up to specified current capability in normal operation, but when an over current situation occurs, the output voltage and current decrease until the over current condition ends. Typical characteristics of this protection scheme are shown in the Output voltage versus Output current graphs in the characterization section of this datasheet.

NCP4681, NCP4684

Output Discharger

The NCP4681D version includes a transistor between VOUT and GND that is used for faster discharging of the output capacitor. This function is activated when the IC goes into disable mode.

Thermal

As power across the IC increase, it might become necessary to provide some thermal relief. The maximum power dissipation supported by the device is dependent upon board design and layout. Mounting pad configuration

on the PCB, the board material, and also the ambient temperature affect the rate of temperature increase for the part. When the device has good thermal conductivity through the PCB the junction temperature will be relatively low in high power dissipation applications.

PCB layout

Make the VIN and GND line as large as practical. If their impedance is high, noise pickup or unstable operation may result. Connect capacitors C1 and C2 as close as possible to the IC, and make wiring as short as possible.

ORDERING INFORMATION

Device	Nominal Output Voltage	Description	Marking	Package	Shipping [†]
NCP4681DMX29TCG	2.9 V	Auto discharge	B (fixed)*	XDFN0808 (Pb-Free)	10000 / Tape & Reel
NCP4681DMX33TCG	3.3 V	Auto discharge	B (fixed)*	XDFN0808 (Pb-Free)	10000 / Tape & Reel
NCP4681DMX35TCG	3.5 V	Auto discharge	B (fixed)*	XDFN0808 (Pb-Free)	10000 / Tape & Reel
NCP4681HMX35TCG	3.5 V	Enable high	B (fixed)*	XDFN0808 (Pb-Free)	10000 / Tape & Reel
NCP4681DSQ15T1G	1.5 V	Auto discharge	AQ15	SC-70 (Pb-Free)	3000 / Tape & Reel
NCP4681DSQ25T1G	2.5 V	Auto discharge	AQ25	SC-70 (Pb-Free)	3000 / Tape & Reel
NCP4681DSQ28T1G	2.8 V	Auto discharge	AQ28	SC-70 (Pb-Free)	3000 / Tape & Reel
NCP4681DSQ33T1G	3.3 V	Auto discharge	AQ33	SC-70 (Pb-Free)	3000 / Tape & Reel
NCP4684EMX25TCG	2.5 V	Without Enable	B (fixed)*	XDFN0808 (Pb-Free)	10000 / Tape & Reel
NCP4684EMX33TCG	3.3 V	Without Enable	B (fixed)*	XDFN0808 (Pb-Free)	10000 / Tape & Reel

[†]For information on tape and reel specifications, including part orientation and tape sizes, please refer to our Tape and Reel Packaging Specifications Brochure, BRD8011/D.

*Marking codes for XDFN0808 packages are unified.

**To order other package and voltage variants, please contact your ON Semiconductor sales representative.

MECHANICAL CASE OUTLINE PACKAGE DIMENSIONS



SCALE 2:1

SC-88A (SC-70-5/SOT-353) CASE 419A-02 ISSUE M

DATE 11 APR 2023



RECOMMENDED MOUNTING FOOTPRINT

* For additional information on our Pb-Free strategy and soldering details, please download the ON Semiconductor Soldering and Mounting Techniques Reference Manual, SOLDERM/D.

NOTES:

1. DIMENSIONING AND TOLERANCING PER ANSI Y14.5M, 1982.
2. CONTROLLING DIMENSION: MILLIMETERS
3. 419A-01 OBSOLETE. NEW STANDARD 419A-02
4. DIMENSIONS D AND E1 DO NOT INCLUDE MOLD FLASH, PROTRUSIONS, OR GATE BURRS. MOLD FLASH, PROTRUSIONS, OR GATE BURRS SHALL NOT EXCEED 0.1016MM PER SIDE.

DIM	MILLIMETERS		
	MIN.	NOM.	MAX.
A	0.80	0.95	1.10
A1	---	---	0.10
A3	0.20 REF		
b	0.10	0.20	0.30
c	0.10	---	0.25
D	1.80	2.00	2.20
E	2.00	2.10	2.20
E1	1.15	1.25	1.35
e	0.65 BSC		
L	0.10	0.15	0.30

GENERIC MARKING DIAGRAM*



*This information is generic. Please refer to device data sheet for actual part marking. Pb-Free indicator, "G" or microdot "▪", may or may not be present. Some products may not follow the Generic Marking.

XXX = Specific Device Code

M = Date Code

▪ = Pb-Free Package

(Note: Microdot may be in either location)

STYLE 1:

- PIN 1. BASE
- EMITTER
- BASE
- COLLECTOR
- COLLECTOR

STYLE 2:

- PIN 1. ANODE
- EMITTER
- BASE
- COLLECTOR
- CATHODE

STYLE 3:

- PIN 1. ANODE 1
- N/C
- ANODE 2
- CATHODE 2
- CATHODE 1

STYLE 4:

- PIN 1. SOURCE 1
- DRAIN 1/2
- SOURCE 1
- GATE 1
- GATE 2

STYLE 5:

- PIN 1. CATHODE
- COMMON ANODE
- CATHODE 2
- CATHODE 3
- CATHODE 4

STYLE 6:

- PIN 1. EMITTER 2
- BASE 2
- EMITTER 1
- COLLECTOR
- COLLECTOR 2/BASE 1

STYLE 7:

- PIN 1. BASE
- EMITTER
- BASE
- COLLECTOR
- COLLECTOR

STYLE 8:

- PIN 1. CATHODE
- COLLECTOR
- N/C
- BASE
- EMITTER

STYLE 9:

- PIN 1. ANODE
- CATHODE
- ANODE
- ANODE
- ANODE

Note: Please refer to datasheet for style callout. If style type is not called out in the datasheet refer to the device datasheet pinout or pin assignment.

DOCUMENT NUMBER:	98ASB42984B	Electronic versions are uncontrolled except when accessed directly from the Document Repository. Printed versions are uncontrolled except when stamped "CONTROLLED COPY" in red.
DESCRIPTION:	SC-88A (SC-70-5/SOT-353)	PAGE 1 OF 1

onsemi and ONSEMI are trademarks of Semiconductor Components Industries, LLC dba onsemi or its subsidiaries in the United States and/or other countries. onsemi reserves the right to make changes without further notice to any products herein. onsemi makes no warranty, representation or guarantee regarding the suitability of its products for any particular purpose, nor does onsemi assume any liability arising out of the application or use of any product or circuit, and specifically disclaims any and all liability, including without limitation special, consequential or incidental damages. onsemi does not convey any license under its patent rights nor the rights of others.

MECHANICAL CASE OUTLINE

PACKAGE DIMENSIONS

ON Semiconductor®



SCALE 4:1

XDFN4 0.8x0.8, 0.48P
CASE 711AB-01
ISSUE O

DATE 21 OCT 2010

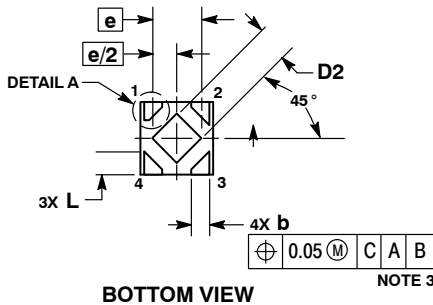
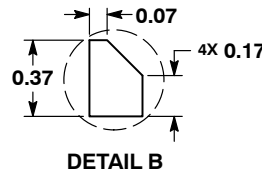
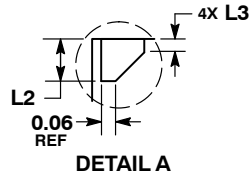
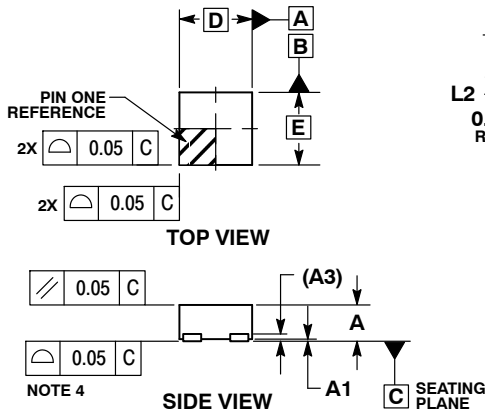

RECOMMENDED MOUNTING FOOTPRINT*

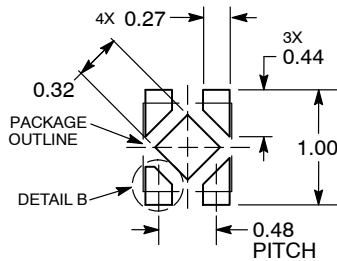

DIMENSIONS: MILLIMETERS

NOTES:

1. DIMENSIONING AND TOLERANCING PER ASME Y14.5M, 1994.
2. CONTROLLING DIMENSION: MILLIMETERS.
3. DIMENSION b APPLIES TO PLATED TERMINALS.
4. COPLANARITY APPLIES TO THE EXPOSED PAD AS WELL AS THE TERMINALS.

MILLIMETERS		
DIM	MIN	MAX
A	---	0.40
A1	0.00	0.05
A3	0.10	REF
b	0.17	0.27
D	0.80	BSC
D2	0.20	0.30
E	0.80	BSC
e	0.48	BSC
L	0.23	0.33
L2	0.17	0.27
L3	0.01	0.11

GENERIC MARKING DIAGRAM*

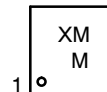

X = Specific Device Code
MM = Date Code

*This information is generic. Please refer to device data sheet for actual part marking.
Pb-Free indicator, "G" or microdot "▪", may or may not be present.

*For additional information on our Pb-Free strategy and soldering details, please download the ON Semiconductor Soldering and Mounting Techniques Reference Manual, SOLDERRM/D.

DOCUMENT NUMBER:	98AON53252E	Electronic versions are uncontrolled except when accessed directly from the Document Repository. Printed versions are uncontrolled except when stamped "CONTROLLED COPY" in red.
DESCRIPTION:	XDFN4, 0.8X0.8, 0.48P	PAGE 1 OF 1

ON Semiconductor and are trademarks of Semiconductor Components Industries, LLC dba ON Semiconductor or its subsidiaries in the United States and/or other countries. ON Semiconductor reserves the right to make changes without further notice to any products herein. ON Semiconductor makes no warranty, representation or guarantee regarding the suitability of its products for any particular purpose, nor does ON Semiconductor assume any liability arising out of the application or use of any product or circuit, and specifically disclaims any and all liability, including without limitation special, consequential or incidental damages. ON Semiconductor does not convey any license under its patent rights nor the rights of others.

onsemi, **Onsemi**, and other names, marks, and brands are registered and/or common law trademarks of Semiconductor Components Industries, LLC dba "**onsemi**" or its affiliates and/or subsidiaries in the United States and/or other countries. **onsemi** owns the rights to a number of patents, trademarks, copyrights, trade secrets, and other intellectual property. A listing of **onsemi**'s product/patent coverage may be accessed at www.onsemi.com/site/pdf/Patent-Marking.pdf. **onsemi** reserves the right to make changes at any time to any products or information herein, without notice. The information herein is provided "as-is" and **onsemi** makes no warranty, representation or guarantee regarding the accuracy of the information, product features, availability, functionality, or suitability of its products for any particular purpose, nor does **onsemi** assume any liability arising out of the application or use of any product or circuit, and specifically disclaims any and all liability, including without limitation special, consequential or incidental damages. Buyer is responsible for its products and applications using **onsemi** products, including compliance with all laws, regulations and safety requirements or standards, regardless of any support or applications information provided by **onsemi**. "Typical" parameters which may be provided in **onsemi** data sheets and/or specifications can and do vary in different applications and actual performance may vary over time. All operating parameters, including "Typicals" must be validated for each customer application by customer's technical experts. **onsemi** does not convey any license under any of its intellectual property rights nor the rights of others. **onsemi** products are not designed, intended, or authorized for use as a critical component in life support systems or any FDA Class 3 medical devices or medical devices with a same or similar classification in a foreign jurisdiction or any devices intended for implantation in the human body. Should Buyer purchase or use **onsemi** products for any such unintended or unauthorized application, Buyer shall indemnify and hold **onsemi** and its officers, employees, subsidiaries, affiliates, and distributors harmless against all claims, costs, damages, and expenses, and reasonable attorney fees arising out of, directly or indirectly, any claim of personal injury or death associated with such unintended or unauthorized use, even if such claim alleges that **onsemi** was negligent regarding the design or manufacture of the part. **onsemi** is an Equal Opportunity/Affirmative Action Employer. This literature is subject to all applicable copyright laws and is not for resale in any manner.

ADDITIONAL INFORMATION

TECHNICAL PUBLICATIONS:

Technical Library: www.onsemi.com/design/resources/technical-documentation
onsemi Website: www.onsemi.com

ONLINE SUPPORT: www.onsemi.com/support

For additional information, please contact your local Sales Representative at www.onsemi.com/support/sales

